

Introduction

We are pleased to provide you with this public relations material, entitled "All About the Toyota Twin-cam 2nd Edition".

Toyota has enthusiastically advanced the development of high performance and fuel-efficient engines as six new mass production twin-cam engines have been developed since February, 1981. February, 1981 also coincides with the first edition of this publication (entitled "All About the Toyota Twin-cam"), and the initial release to market of the Soarer.

This publication has been produced to help you to understand all about the Toyota twin-cam engine, including Toyota's achievements.

The various attributes required of a vehicle, like energy efficiency, high quality, features, desirable driving performance etc. have continued to strengthen the tendency toward diversification.

Toyota has answered these needs with a plan - an engine, the heart of a vehicle, that sees the coexistence of high performance and high fuel economy. Toyota's new generation **LASRE** engine series, the technical solution to this challenge, has received an excellent response with its successful mass production and arrival in the market.

If this publication helps everyone to understand the Toyota twin-cam, the peak of Toyota's engine technology, we will be pleased.

The cover shows a cutaway view of the 1G-GEU, a Toyota twin-cam engine.

表紙はトヨタツインカム「1G-GEU」の透視図

Contents

Introduction

What is a twin-cam engine? — 2

Toyota twin-cam engines — 3

Toyota twin-cam profiles

Increasing the number of twin-cam Toyotas — 4

Toyota twin-cam engines and main specifications — 6

5M—GEU / 6M—GEU — 8

1G—GEU — 10

3T—GTEU / 4T—GTEU — 12

4A—GEU / 4A—GELU — 14

3S—GELU — 16

LASRE α —X — 18

Advanced technologies — 20

The making of a Toyota twin-cam — 22

Motorsports and the Toyota twin-cam — 24

Progress of the Toyota twin-cam — 26

Progression of Toyota engines — 28

Introduction

What is a twin-cam engine?

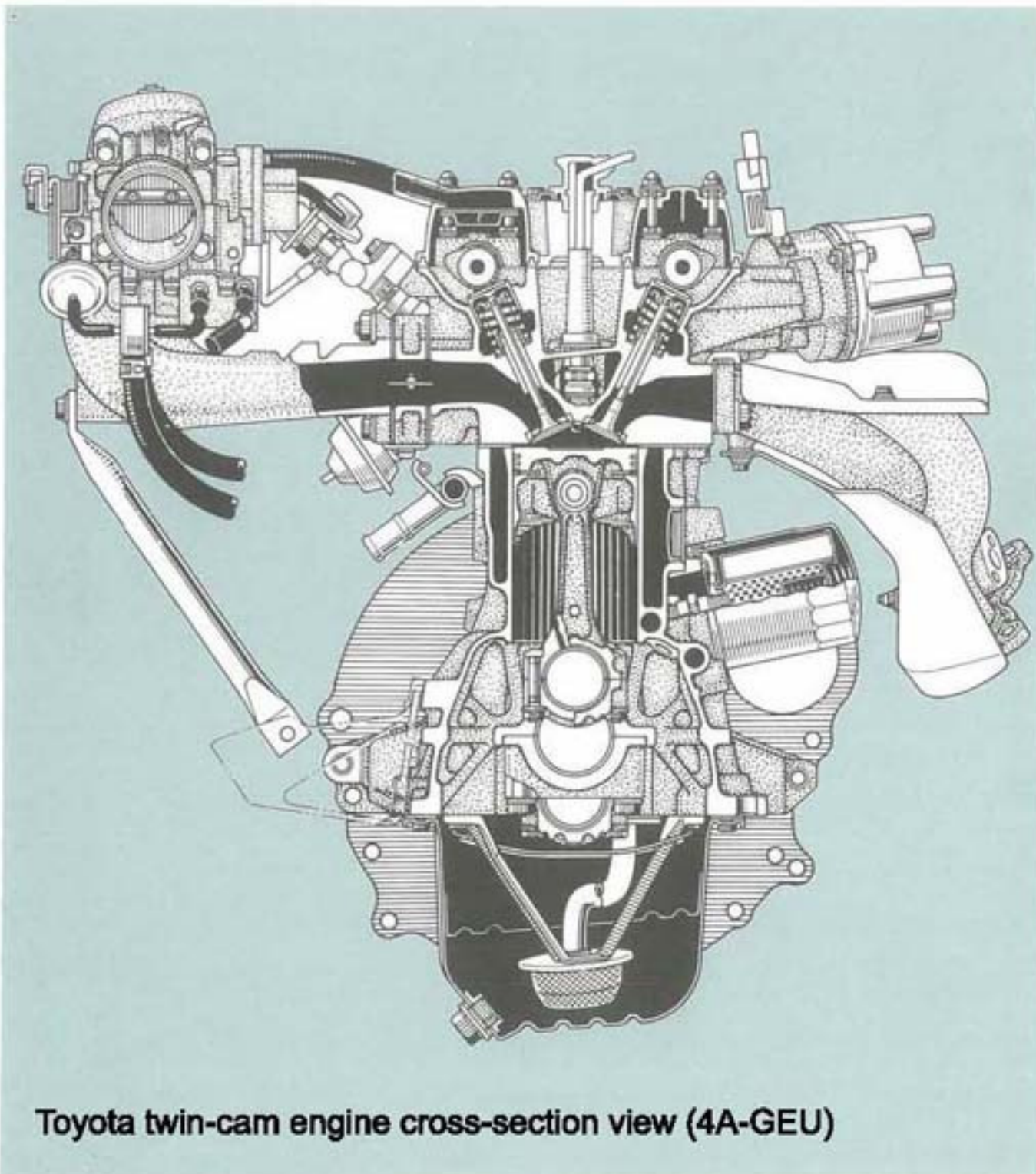

Basically, a twin cam engine is a four-cycle engine that opens and closes its intake valves with one camshaft, and its exhaust valves with another. Because the camshafts are located above the cylinder head, it is referred to as a Double Over Head Camshaft (DOHC) engine.

A characteristic of this design is that high volumetric efficiency becomes possible due to the large diameter valves and a low inertia valvetrain that makes it possible to have a higher maximum valvetrain speed. Put simply, this results in a high speed, high power engine.

Four valves make high power possible

On a four-valve engine, each cylinder has a pair of intake valves and a pair of exhaust valves. A four-valve cylinder head has a greater total valve opening area than a two-valve head. This makes it easier for the incoming charge to enter the cylinder, and for the outgoing charge to leave the cylinder. If you take this increased amount of air, and add the proper amount of fuel, the corresponding power output is also higher than a two-valve engine. Generally speaking, when a twin cam design and a four valve design are combined, this is referred to as a twin-cam, four-valve engine. If the number of cylinders is taken into account, a four-cylinder engine is referred to as a 16-valve twin-cam engine, and a 6-cylinder is referred to as a 24-valve twin-cam engine.

Twin-cam engine main components

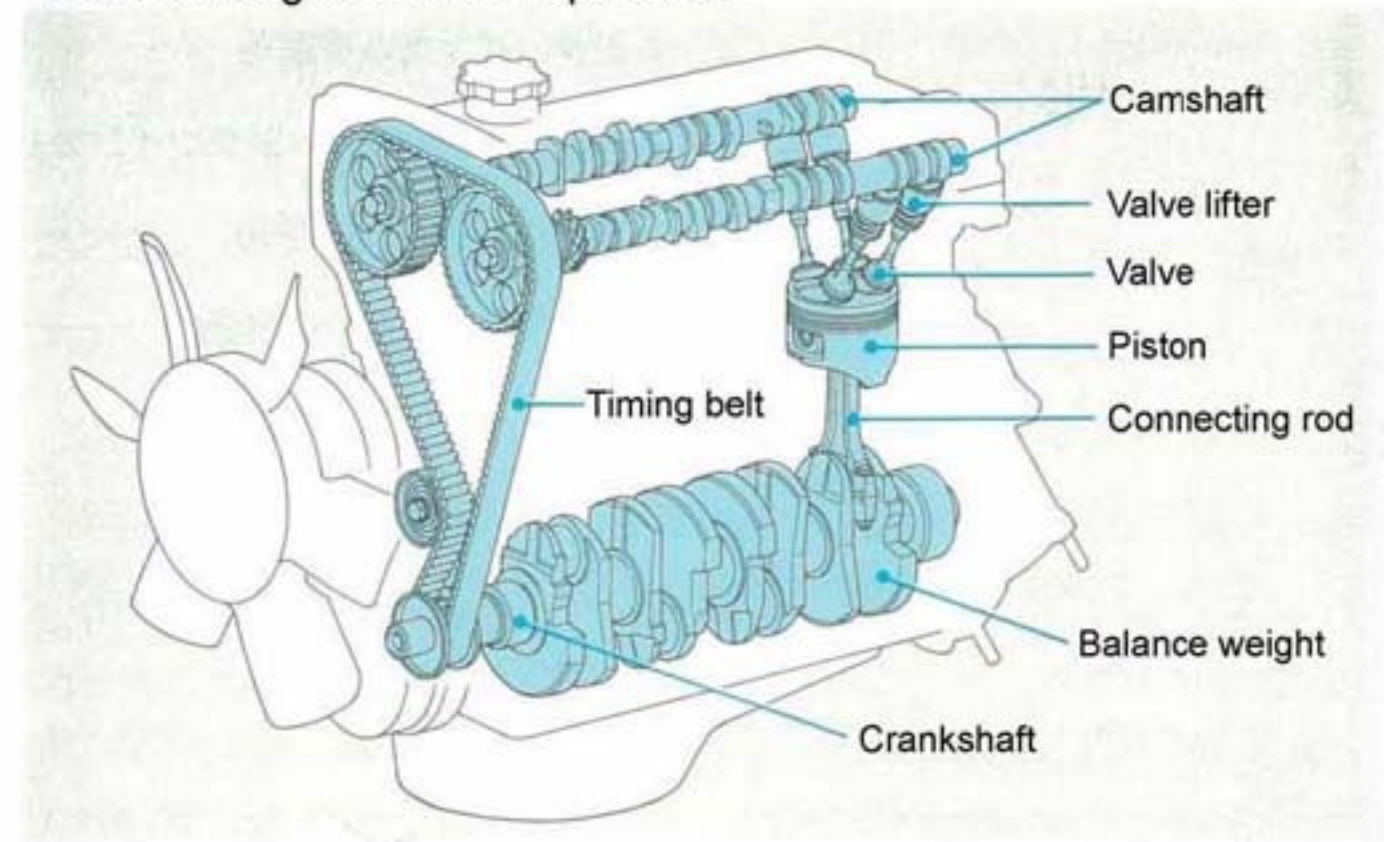

Introduction

Toyota twin-cam engines

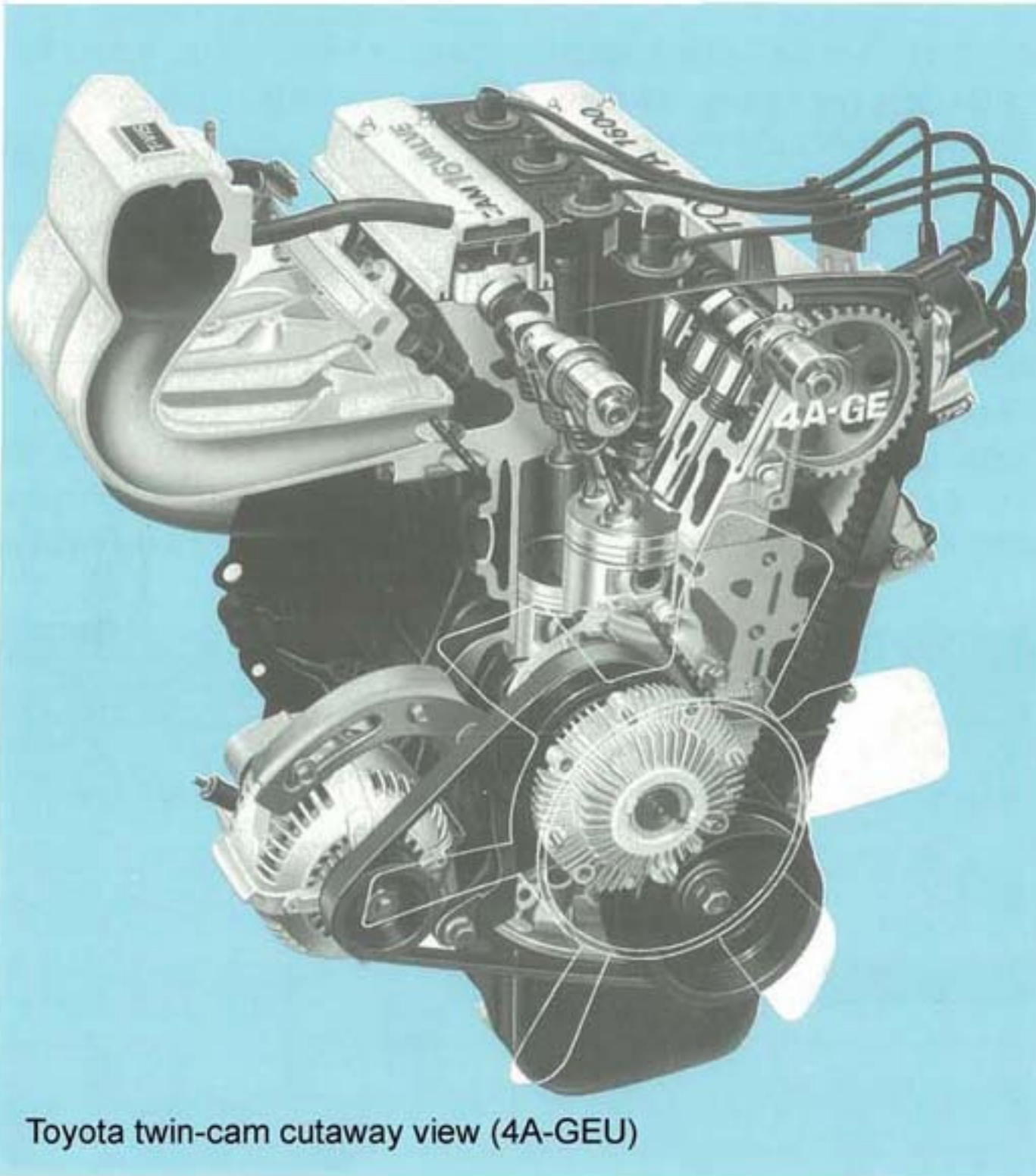

Toyota twin-cam cutaway view (4A-GEU)

The idea of Toyota's founder, Kiichiro Toyoda, that a car is something to be accessible to the general public, still holds true at Toyota. Toyota is now putting this idea into practice by introducing new technology, providing customers with high quality, high performance, and products that offer value. The development of high performance, fuel efficient, easy-to-use twin cam four valve engines and installing them in a wide range of models is one of the ways this thinking is being put into practice.

Taking a second look at engine theory

Until now, twin cam engines have been thought to be suited to sports car fans or enthusiasts, to say nothing of a 4 valve per cylinder valvetrain, something that only seemed to be for racing engines. The emission regulations which began in 1965, and the two oil shocks both seemed poised to make the twin cam engine disappear. In spite of this, the application of electronic fuel injection made it possible to keep the twin cam engine, while simultaneously providing Toyota with an opportunity to address environmental and energy efficiency needs. The solutions sought by the question "what is an engine" required a very close look. In order to develop countermeasures for exhaust emissions, a project team of specialist engineers with different backgrounds was brought together to study the fundamentals of combustion, emissions rectification, and improve technical ability.

LASRE concept

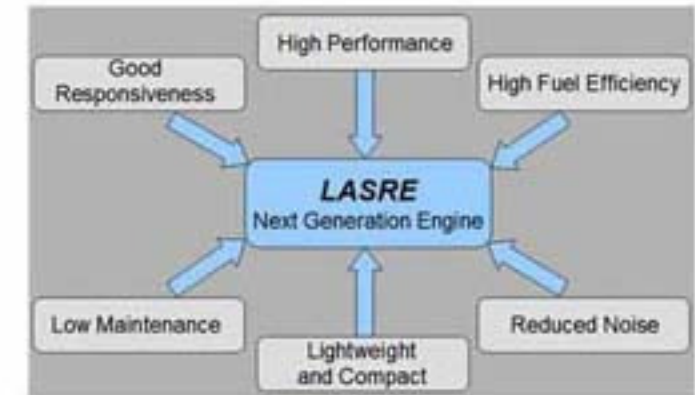

The result of accumulating technical knowledge

On the other hand, customer's needs have become diversified as cars have become more accessible to the masses. Some request economy, some request quietness, and some request luxurious equipment. In addition to these requests, a large number also require high performance. Power, superb responsiveness — Toyota has devoted its energies to the research and development of technology to meet these customer requirements. One technology is the twin cam engine, and another is the twin cam turbo engine. Toyota's accumulated technical knowledge makes it possible to draw out the high performance of a twin cam and four-valve twin cam, while having the engine remain easy-to-use, even at low speeds. In addition, a steady idle and quietness are also made possible, together with high dependability and serviceability. Naturally, the fuel economy is good, --- Toyota's goal was to develop a high performance twin cam engine that can be experienced by a large number of people. Again, this is the starting point of the **LASRE** concept, an idea that is also connected with Fun to Drive.

Toyota twin-cam profiles

Increasing the number of twin-cam equipped Toyotas

Toyota twin-cam engines were installed to a total of 17 models as of the end of October 1984, all the way from the Crown and Soarer to the Corolla and Sprinter. The Toyota twin-cam engine is an engine that answers the customer's calls for an engine with high performance and fuel efficiency. These are not just engines for enthusiasts vehicles, these are high performance engines for a wide range of customers, suited all vehicle drive types, everything from rear-drive vehicles like the Soarer, front wheel drive vehicles like the Camry and Corolla sedans and even the first Japanese developed mid engine rear drive vehicle.

a dominant engine in motorsports, one loved by many, especially the young. Vehicles with this engine range from the lightweight and sporty rear wheel drive Corolla Levin and Sprinter Trueno coupes, the front wheel drive Corolla and Sprinter sedans, to the midship MR2. The 3T-GTEU was the first twin-cam engine in Japan to be fitted with a turbocharger. The 3T-GTEU, installed in the front engine rear drive (FR) layout in the Celica, formed the basis of the 4T-GTE engine that is playing an active role in the Safari Rally and WEC endurance race, leveraging the excellence of the basic design.

The 1G-GEU is a smooth spinning 6-cylinder engine for compact cars that unites both high power output and good fuel economy with an engine displacement suitable for use in compact cars (sub 2000 cc gasoline engine).

The 3S-GELU engine is exclusively for use in front engine front wheel drive vehicles (FF vehicles). This engine, with its fitment in FF vehicles, is transversely mounted along with the transaxle. In Japan, where the width of compact cars is required to be 1.7m or less, this results in a need to design the engine with a length as short as possible. In this respect, the compact 3S-GELU shines.

The 5M-GEU/6M-GEU is the engine that stands at the top of the Toyota twin-cam range. Ample low to mid speed torque is generated by this large displacement six cylinder twin-cam engine.

In combination with an automatic transmission, this is an engine that demonstrates a feeling of good acceleration at low to mid engine speeds, as well as demonstrating the ability to sustain its drive through high engine speeds. It is installed in top level models of the Crown, Soarer, and Celica XX.

Achieving production of 1 million twin-cam engines

Toyota is the mass production maker of twin cam engines. Starting with the 3M engine in the 2000 GT, through to the end of June 1984, the twin cam engine production total has reached one million units. As part of this, annual production for 1983 reached a volume of 260,000 units. (continued on following page)

Different engine personalities for different models

Toyota twin-cam engines are consistent in having a combination of light weight, compactness, good fuel economy, high power and superior response; however, each engine has a unique character. Let's review these engines starting from the smallest displacement. The 4A-GEU/4A-GELU is the twin-cam engine with the smallest displacement. It is the successor to the 2T-G in both displacement and character,

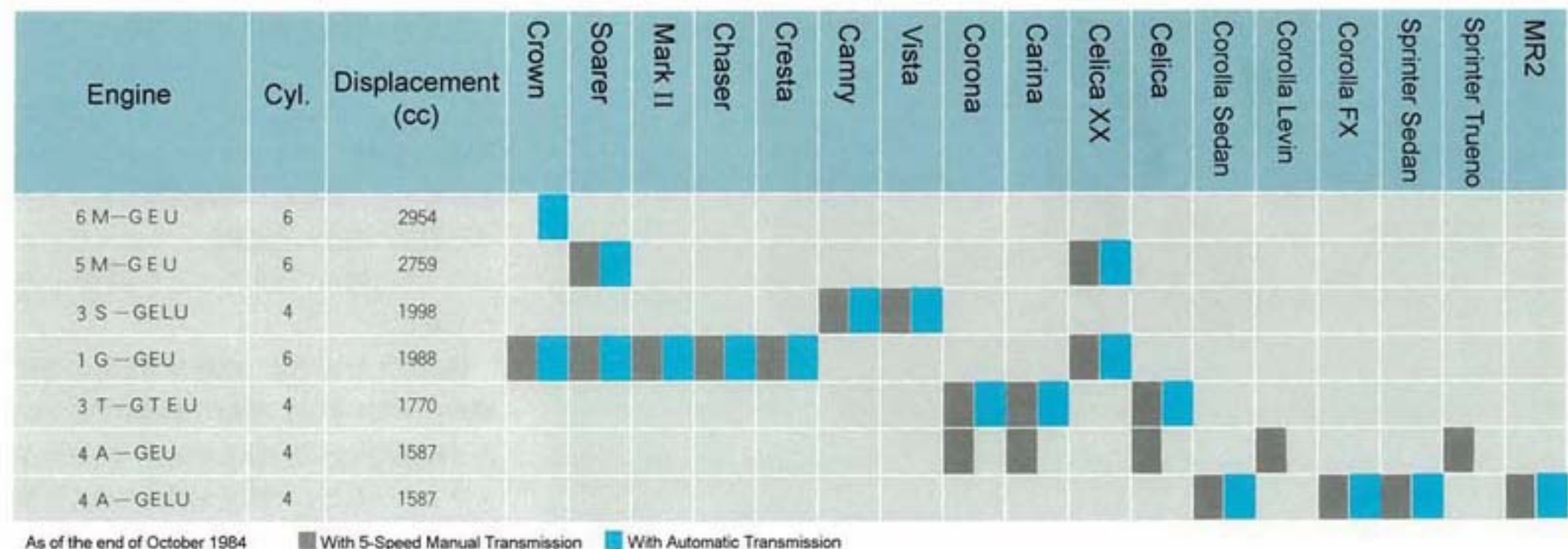

Toyota twin-cam profiles

The number of twin-cam equipped Toyota vehicles (new vehicles) reached about 175,000 for 1983, twice or better than the previous year, and for the first time, the percentage of Toyota passenger cars equipped with twin cam engines that were newly registered in Japan exceeded 10%. As for the percentage of twin-cam equipped passenger cars, for the period between January to June 1984, the share of twin-cam equipped Toyota vehicles has reached 19.8%; evidence of appreciation in the marketplace.

In addition, Toyota's share of the twin cam vehicles registered in Japan over the past few years, including twin cam vehicles from other makers, is high - reaching 80 to 90%, cementing the position of Toyota twin-cam vehicles in the market.

The following is the percentage of twin cam engine equipped models, by name (January to June 1984): MR2 99.2% (a special case), Soarer 73.6%, Celica (including XX) 72.6%, Crown 53.6% and others.

Toyota engine codes

Example 1

3T-GTEU

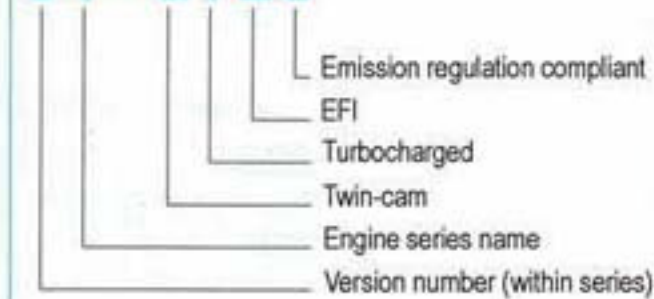

Example 2

4A-GELU

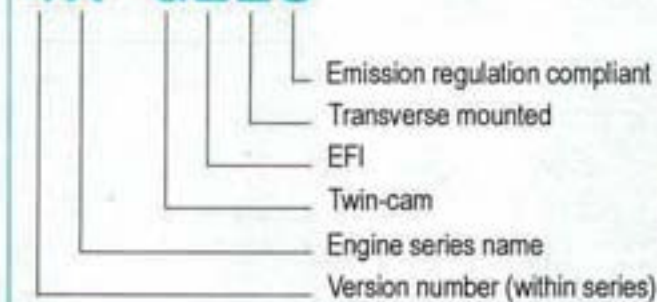

One million Toyota twin-cam engines produced: A breakdown (as of the end of June 1984)



Toyota MR2 release presentation

Registrations of Toyota vehicles (by model name)

Vehicle name	1980	1981	1982	1983	1984 (Jan to June)
Crown	—	10,528	21,918	39,536 (38.1)	34,477 (53.6)
Soarer	—	15,234	9,312	19,667 (69.5)	11,390 (73.6)
Mark II	556	1,423	3,971	19,028 (17.2)	9,946 (19.7)
Chaser	341	991	2,011	3,846 (13.5)	1,725 (13.7)
Cresta	—	—	2,387	12,959 (20.0)	7,124 (22.1)
Camry	2,288	6,018	1,104	—	663 (2.5)
Vista	—	—	—	—	308 (2.5)
Corona	4,569	1,624	7,948	9,508 (6.9)	5,504 (6.1)
Carina	8,748	7,391	7,292	13,892 (11.9)	4,645 (7.4)
Celica	9,128	9,800	10,190	14,955 (70.3)	6,242 (72.6)
Corolla	14,396	15,533	9,462	21,490 (10.4)	11,284 (11.5)
Sprinter	6,903	7,540	4,501	20,118 (17.4)	10,715 (19.5)
MR2	—	—	—	—	1,038 (99.2)
Total number of Toyota twin-cam vehicles registered in Japan	46,929	76,082	80,096	174,999 (10.9)	105,061 (19.8)
Total number of twin-cam vehicles registered in Japan	52,306	89,661	100,417	197,341	112,487
Toyota's share (%)	89.7	84.9	79.8	88.7	93.4

This data was compiled internally by Toyota.

The numbers in brackets represent the proportion (%) of each model equipped with a twin-cam engine.

Toyota twin-cam profiles

Succession of Toyota twin-cam engines and main specifications

Item	Engine	3 M	9 R	10R(8R-G)	2T-G	18R-G	18R-GU	2T-GEU
First year of production		1967 (昭42)	1967 (昭42)	1969 (昭44)	1970 (昭45)	1972 (昭47)	1975 (昭50)	1976 (昭51)
Type		Liquid-cooled, In-line DOHC 6-cylinder	Liquid-cooled, In-line DOHC 4-cylinder	Liquid-cooled, In-line DOHC 4-cylinder	Liquid-cooled, In-line DOHC 4-cylinder	Liquid-cooled, In-line DOHC 4-cylinder	Liquid-cooled, In-line DOHC 4-cylinder	Liquid-cooled, In-line DOHC 4-cylinder
Combustion chamber shape		Hemispheric	Hemispheric	Hemispheric	Hemispheric	Hemispheric	Hemispheric	Hemispheric
Bore x stroke (mm)		75×75	80.5×78	86×80	85×70	88.5×80	88.5×80	85×70
Displacement (cc)		1988	1587	1858	1588	1968	1968	1588
Compression Ratio		8.4	9.0	9.7	9.8 (8.8)	9.7 (8.5)	8.3	8.4
Power (ps/rpm)		150/6600	110/6200	140/6400	115/6400 (110/6000)	145/6400 (140/6400)	130/5800	115/6000 *110/6000
Torque (kgm/rpm)		18.0/5000	14.0/5000	17.0/5200	14.5/5200 (14.0/4800)	18.0/5200 (17.2/4800)	16.5/4800	15.0/4800 *14.5/4800
Lowest Brake specific fuel consumption (gr/psh (rpm))		240 (5000)	230 (5000)	210 (6400)	224 (5200) (232 (4800))	210 (5200) (220 (4800))	230 (4800)	215 (4800) *220 (4800)
Size (L x W x H) (mm)		773×726×619	717×774×653	682×727×615	653×677×597	682×723×638	705×721×632	665×658×614 *665×644×646
Weight (kg)		209	174	170	152	170	182	146 *153
Fuel system		3 Solex	2 Solex	2 Solex	2 Solex	2 Solex	2 Solex	EFI
Number produced (as of end of October 1984)		337	2,229	4,931	(*1)	(*2)	(*2)	2T-G type total: 294,438 (Includes cells with *1)
Applicable vehicle		2000 GT	1600 GT	Corona Mark II	Celica Carina Corolla Sprinter	Mark II Celica Liftback Corona Carina	Celica Carina Celica Liftback Corona	Celica Carina Corolla Sprinter

Specifications in brackets are for models designed to operate on unleaded gasoline

* Engines certified to 1976 emissions standards

→ Engines in production at time of writing

18R-GEU	5M-GEU	1G-GEU ^{*4}	3T-GTEU	4T-GTEU ^{*5}	4A-GEU ^{*4} (4A-GELU)	5M-GEU	3S-GELU	6M-GEU
1978 (昭53)	1981 (昭56)	1982 (昭57)	1982 (昭57)	1982 (昭57) (Limited production)	1983 (昭58)	1983 (昭58) (Improved)	1984 (昭59)	1984 (昭59)
Liquid-cooled, In-line DOHC 4-cylinder	Liquid-cooled, In-line DOHC 6-cylinder	Liquid-cooled, In-line DOHC 6-cylinder	Liquid-cooled, Turbocharged, In-line DOHC 4-cylinder	Liquid-cooled, Turbocharged, In-line DOHC 4-cylinder	Liquid-cooled, In-line DOHC 4-cylinder	Liquid-cooled, In-line DOHC 6-cylinder	Liquid-cooled, In-line DOHC 4-cylinder	Liquid-cooled, In-line DOHC 6-cylinder
Hemispheric	Multispheric	Pentroof	Hemispheric	Hemispheric	Pentroof	Multispheric	Pentroof	Multispheric
88.5×80	83×85	75×75	85×78	85.5×78	81×77	83×85	86×86	83×91
1968	2759	1988	1770	1791	1587	2759	1998	2954
8.3	8.8	9.1	7.8	7.8	9.4	9.2	9.2	9.2
135/5800	170/5600	160/6400	160/6000	160/6000	130/6600	175/5600	160/6400	190/5600
17.5/4800	24.0/4400	18.5/5200	21.0/4800	21.0/4800	15.2/5200	24.5/4400	19.0/4800	26.5/4400
220 (3600)	205 (2400)	205 (2800)	205 (2200)	205 (2200)	200 (4800)	205 (2400)	200 (3200)	205 (2400)
705×634×649	822×671×693	799×616×662	685×649×662	685×649×662	617×640×637 (600×631×637)	804×671×682	670×615×655	804×671×690
166	205	160	166	166	123	196	143	197
EFI	EFI	EFI	EFI	EFI	EFI	EFI	EFI	EFI
18R-G type total: 141,338 (includes cells with *2)	(*3)	180,668	30,140	228 (Includes modified versions)	130,165	5M-G type total: 322,725 (Includes cells with *3)	6,965	9,100
Celica, Carina, Corona, Camry, Mark II, Chaser	Soarer Crown Celica XX	Celica XX, Soarer, Mark II, Chaser, Cresta Wagon	Celica Carina Corona	Celica	Corolla, Sprinter, Carina, Celica, Corona, MR2	Soarer Celica XX	Camry Vista	Crown

*4 4-valve design *5 Limited production

Toyota twin-cam profiles

5M-GEU/6M-GEU

High output from large displacement, securing quietness

The 5M-GEU is the mass production engine that demonstrates Toyota's engine technology. By mating its large displacement of 2759 cc with a twin-cam design, high output is demonstrated together with quietness and good fuel economy, making it an easy-to-use favorite. The combustion chamber, with its multispheric shape and overhead spark plug, enhances combustion efficiency while

also serving as an exhaust emissions countermeasure. The intake mixture, because of the squish area on the side opposite the spark plug, has sufficient turbulence (agitation), it can be ignited by a centrally located spark plug with a wide gap. The combustion time is very short, superior combustion is made possible together with clean exhaust emissions; it is a combustion chamber that resists autoignition.

The intake and exhaust is via the cross-flow configuration, with two valves (one intake and one exhaust) in each cylinder. Intake valves with a 44mm diameter, and exhaust valves with a 36mm diameter have been adopted.

One of the main points for the 5M-GEU is the adoption of a timing belt for the camshaft drive. The 2 camshafts, one for the intake, and one for the exhaust, are driven by the timing belt. Unlike the conventional direct installation of camshafts in a cylinder head, this engine uses a method where each camshaft is

provided with its own camshaft housing, and these housings are mounted to the cylinder head. The adoption of the timing belt has greatly contributed not only to quietness but also to lightening. One of the reasons for using the special camshaft housings is the adoption of valve lash adjusters and rocker arms to eliminate valve clearance maintenance. The combination of a twin-cam engine and valve lash adjusters makes this the world-first twin-cam engine with no need for valve clearance maintenance.



Photograph of 6M-GEU



Crown 4-door Hardtop
Royal Saloon G

5M-GEU engine specifications

Type	Liquid-cooled, In-line DOHC 6-cylinder
Displacement	2759
Bore x stroke (mm)	83x85
Compression ratio	9.2
Power (ps/rpm)	175/5600
Torque (kgm/rpm)	24.5/4400

6M-GEU engine specifications

Type	Liquid-cooled, In-line DOHC 6-cylinder
Displacement	2954
Bore x stroke (mm)	83x91
Compression ratio	9.2
Power (ps/rpm)	190/5600
Torque (kgm/rpm)	26.5/4400

Furthermore, for the ignition system, the adoption of platinum tipped spark plugs and a contact-point free fully transistorized distributor has drastically reduced maintenance.

The 6M-GEU is a newly developed 3-liter twin cam engine that is based on and furthers the characteristics of the 5M-GEU, generating high power from low to high engine speeds while achieving good fuel economy and quietness. The displacement has been increased to 2954 cc by extending the stroke by 6 mm.

To achieve the full effect of the displacement increase, the intake runner diameter has been increased from 35 to 37mm, improving high-speed intake performance. Together with this, to achieve a significant improvement in low to mid speed torque, a dual surge tank (intake manifold) has been adopted. This dual surge tank reduces the intake interference between cylinders 1-2-3, and cylinders 4-5-6, and improves intake efficiency; the shape of the partition is also designed to avoid degradation of torque at high engine speeds.

This engine also newly adopts the Knock Control System (KCS), preventing knock, and ensuring that the engine performance is always optimal.

For the 6M-GEU, piston thermal deformation has been restrained by the establishment of a reinforcement strut in the piston, and the crankshaft balance rate has been improved. As a result of the use of Finite Element Method (FEM) analysis to optimize the design, the increase of vibration noise due to the displacement increase has been held to zero, the same level as the 5M-GEU has been maintained.

Knock Control System (KCS)

In most cases, both excellent power output and fuel economy are possible from gasoline engines when the ignition timing is controlled to a point just before that at which knocking occurs. The KCS maintains the ignition timing at this point. In order to achieve good fuel economy and power output, when the ignition timing has been retarded due to the occurrence of knock, the ignition timing is gradually advanced again as long as knock does not recur. The main merits are the rapid detection of and control response to knock.

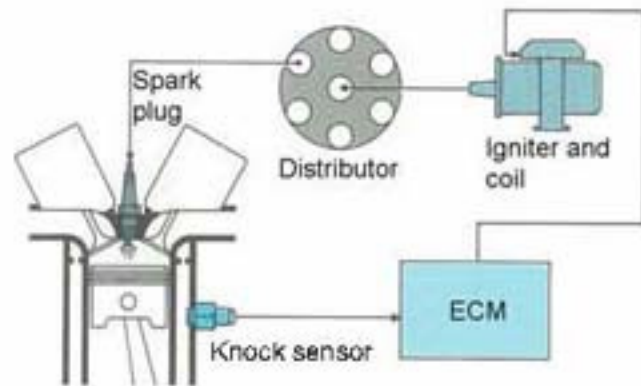

Knock control system

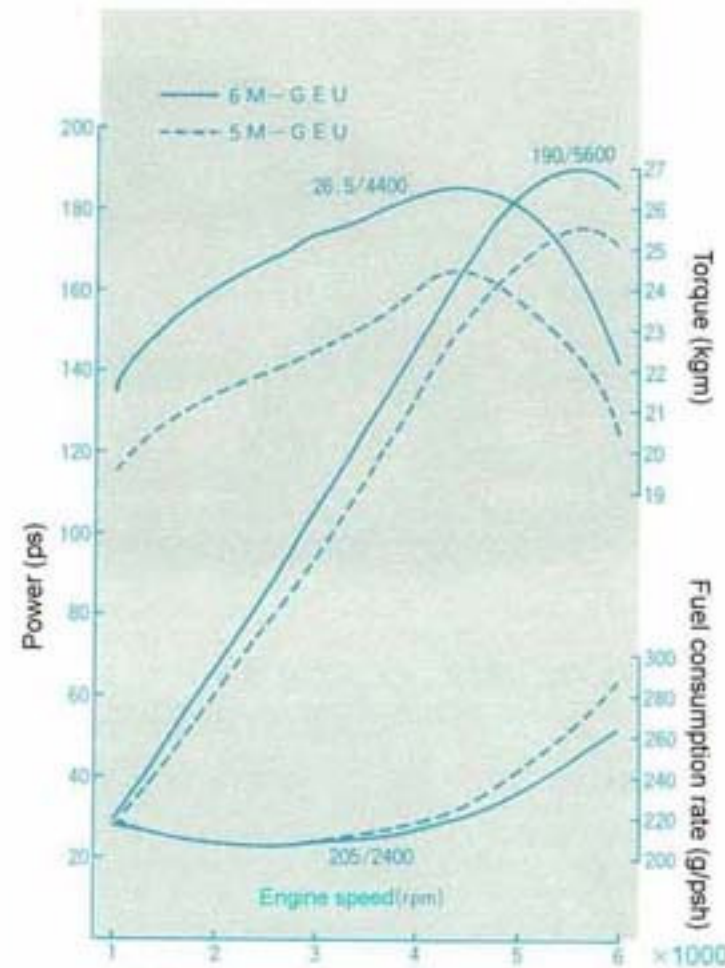

Engine performance curve

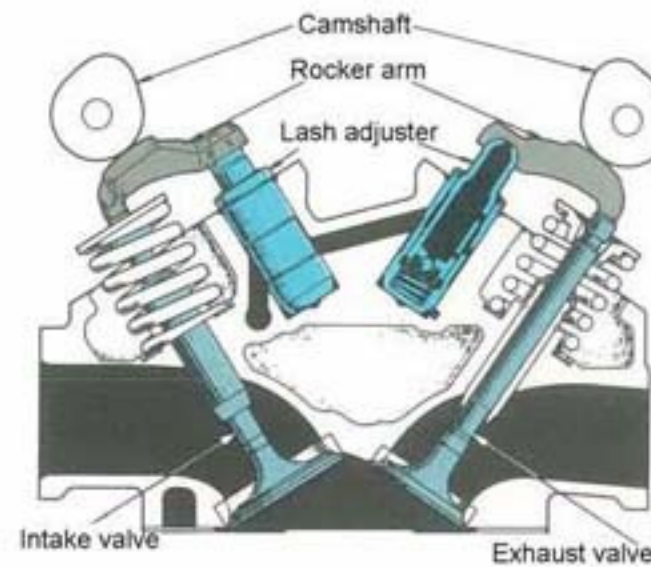

Valve lash adjuster

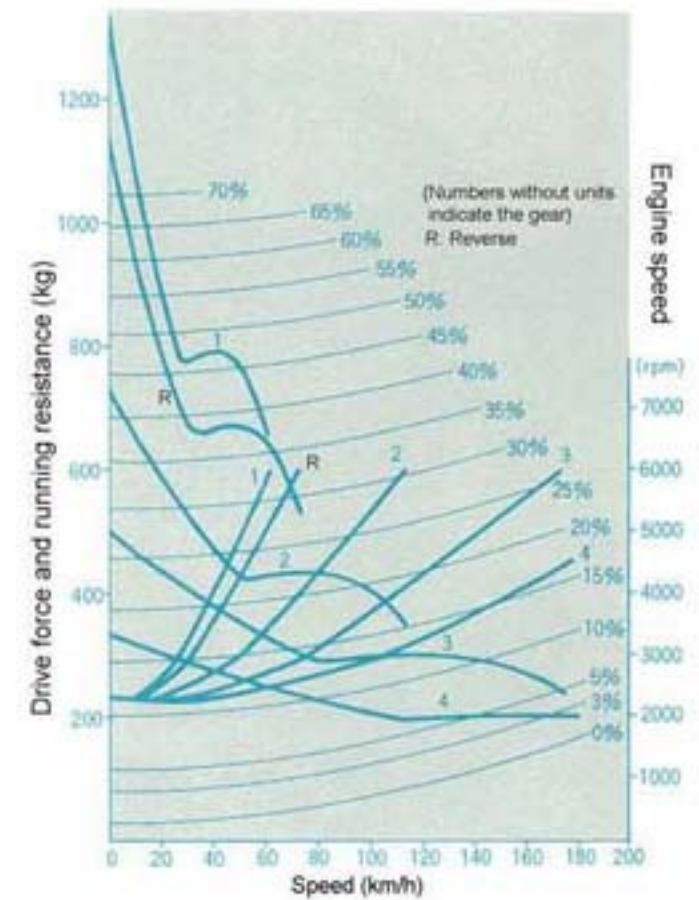

Driving performance curve

Crown 4-door Hardtop Royal Saloon G (4-AT)

Chronology

Feb. 1981	5M-GEU newly developed, fitted to Soarer
Jul. 1981	5M-GEU fitted to Celica XX
Aug. 1981	5M-GEU fitted to Crown
Aug. 1983	5M-GEU improvement, maximum power increased by 5 ps
Aug. 1984	6M-GEU newly developed, fitted to Crown

Toyota twin-cam profiles

1G-GEU

Toyota's first twin-cam 4-valve

The 1G-GEU is the first twin-cam 4 valve engine for Toyota to bring to market. It uses a timing belt to drive the camshafts, direct operation of the valves by the camshaft, the Toyota variable induction system (T-VIS) and others. The technology used in following Toyota 4-valve engines basically got its start with the 1G-GEU.

The high performance 1G-GEU, together with its base engine, the 1G-EU, shone brightly with the win of the

"JSME Medal for New Technology" from the Japan Society of Mechanical Engineers (JSME). With the conversion to a twin cam engine, to enhance high speed and high power durability, the crankshaft was strengthened, the connecting rods were reinforced, a lightweight flywheel was adopted to reduce bending vibration, and a crankshaft pulley with a dual damper was adopted to control torsional vibration.

Thus the bottom end of the engine was optimized for high speed operation for use with the 4-valve valvetrain.

The advantage of using four valves is that the intake efficiency at high engine speeds is improved. This is because of the reduced inertia of the valvetrain due to the low weight per valve, and the increased valve opening area.

On the other hand, for 4-valve engines in regular vehicles, one challenge is reduced torque at low to mid engine speeds. The adoption of T-VIS has solved this.

Because of T-VIS, low to mid speed engine torque is increased; this makes possible high output all the way from low engine speeds through to high engine speeds.

A timing belt, which is used for the camshaft drive of the 1G-GEU, is superior in terms of both noise and repair when compared to the former chain drive method. This highly durable belt drive is employed for all Toyota twin-cam 4 valve engines that follow the 1G-GEU.

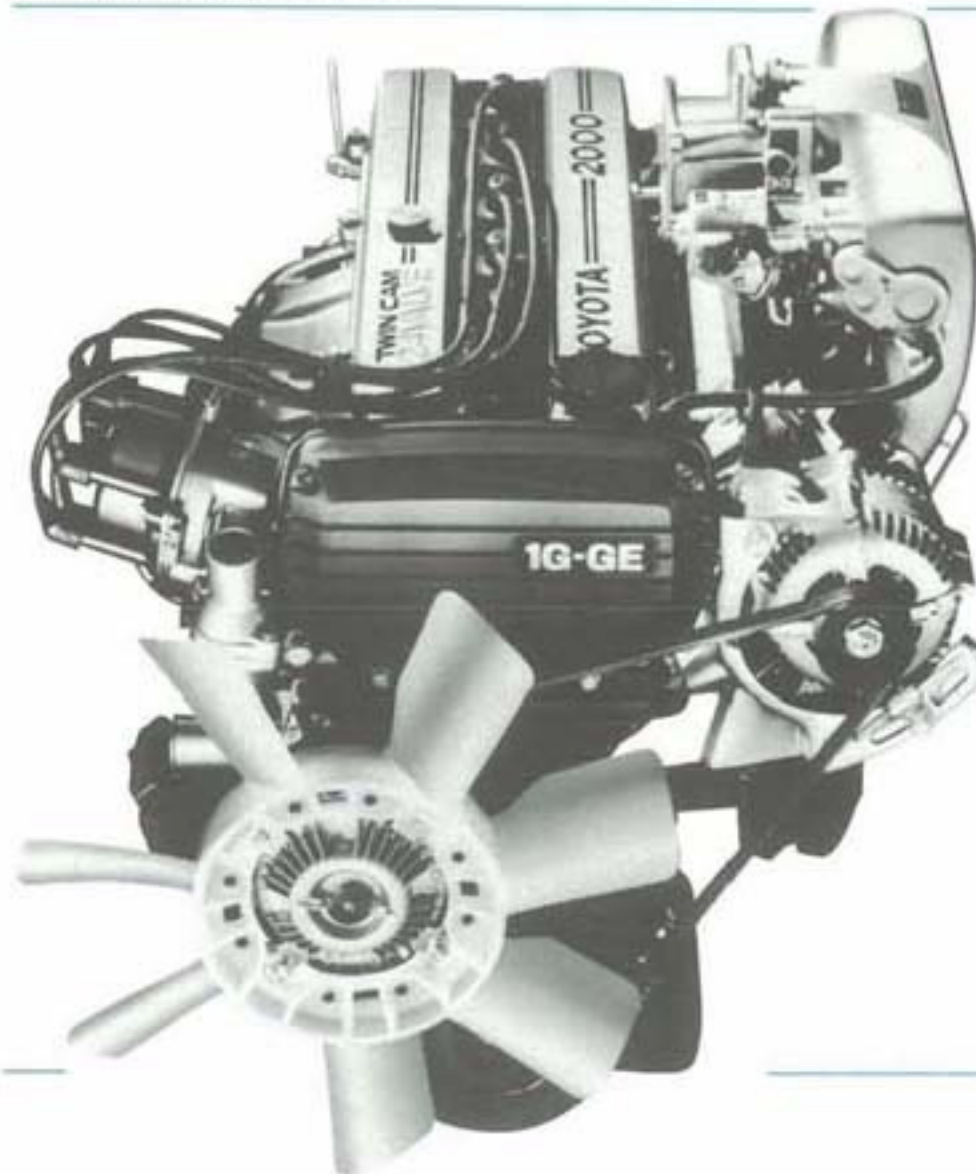

Mark II Hardtop Grande
(Twin-cam 24 Valve)

1G-GEU engine specifications

Type	Liquid-cooled, In-line DOHC 24-valve 6-cylinder
Displacement	1988
Bore x stroke (mm)	75x75
Compression ratio	9.1
Power (ps/rpm)	160/6400
Torque (kgm/rpm)	18.5/5200

Chronology

- Aug. 1982 Newly released, fitted to Celica XX, Mark II, Chaser, Cresta
- Feb. 1983 Fitted to Soarer
- Aug. 1983 Changed to D-type EFI for fuel system, fitted to Crown

In the process of developing the 1G-GEU, a high target was set for the manufacture of the cylinder head. The total length of 1G-GEU, a 6-cylinder engine, is significant, and careful attention was necessary to ensure equal temperature distribution between the cylinders. To achieve this it was necessary to optimize the cooling passage layout and use exacting manufacturing techniques. Additionally, a significant amount of testing was done to determine the optimum runner inside diameter and length, and shape of the T-VIS intake control valves.

The final choices were made to address the needs of both low to mid engine speed torque characteristics and high speed output. To achieve high power output and good fuel economy, all variables were considered when determining the final fuel injector location. Consideration was given to injector mounting in each of the pairs of intake runners (with or without T-VIS intake control valves), and to injector mounting upstream or downstream of the T-VIS intake control valves.

Toyota Variable Induction System

For T-VIS, there is a pair of independent intake runners for each cylinder, with one of each pair having an intake control valve. At low and mid engine speeds the valve is closed, and above a specified engine speed, it opens. The inertia that results from the speed and mass of the airflow created by the vacuum in the cylinder on the intake stroke causes air to continue to enter the cylinder even after the piston begins the compression stroke.

Because it is easy to increase power output when the amount of air that enters the cylinder is large, it is effective to increase the speed of the airflow. T-VIS increases the speed of the airflow by closing the intake control valve at low and mid engine speeds. This causes the air to pass through only one of the two runners. In addition, at this time, a swirl flow is generated by the air that enters the combustion chamber, improving the stability and efficiency of combustion. The valve opens when engine speed becomes high, allowing a large amount of air to enter the cylinder from both runners.

Low to mid engine speeds: Intake control valve closed

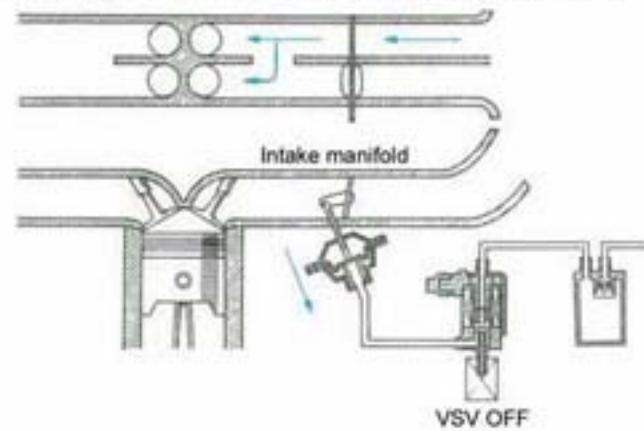

High engine speeds: Intake control valve open

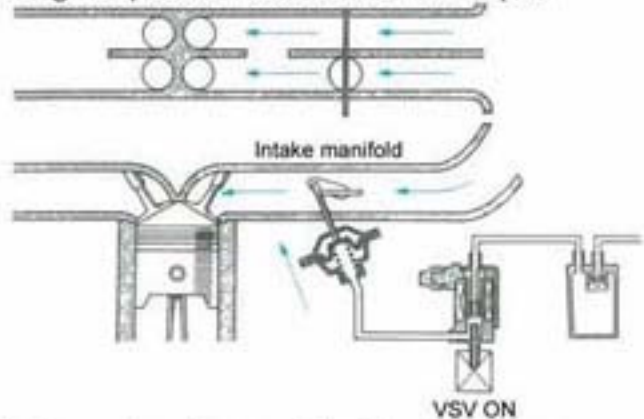

T-VIS mechanism and intake airflow

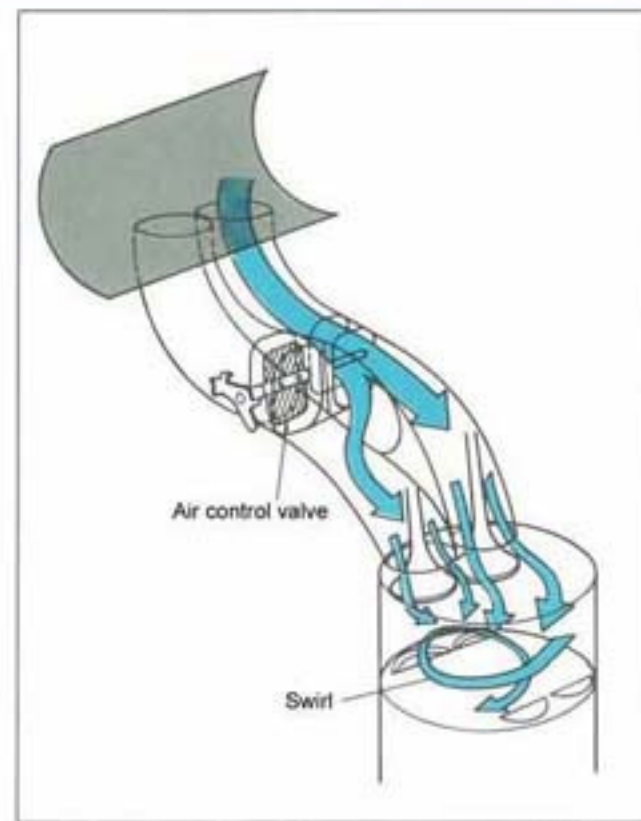

Generation of swirl due to T-VIS (3S-GE shown)

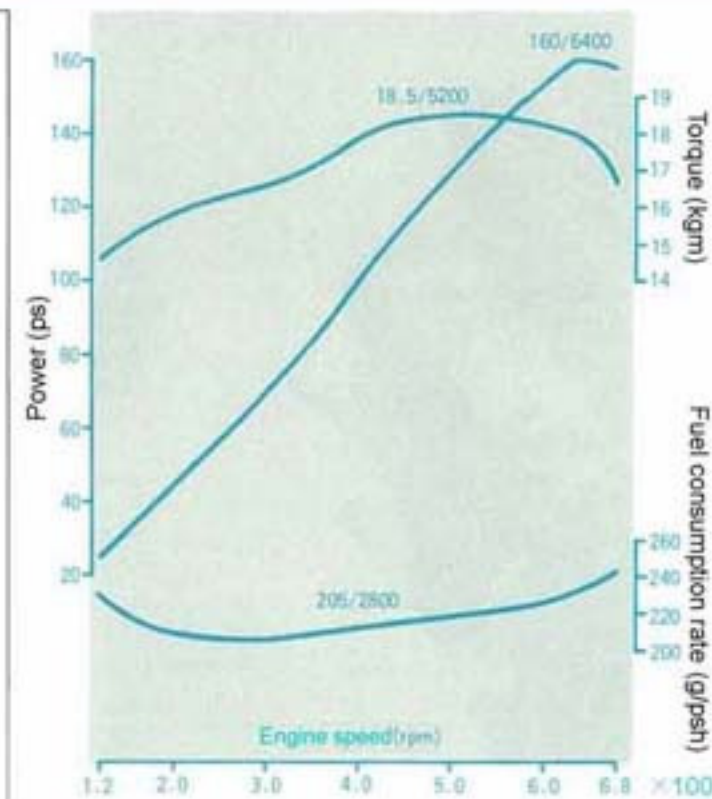

Engine performance curve

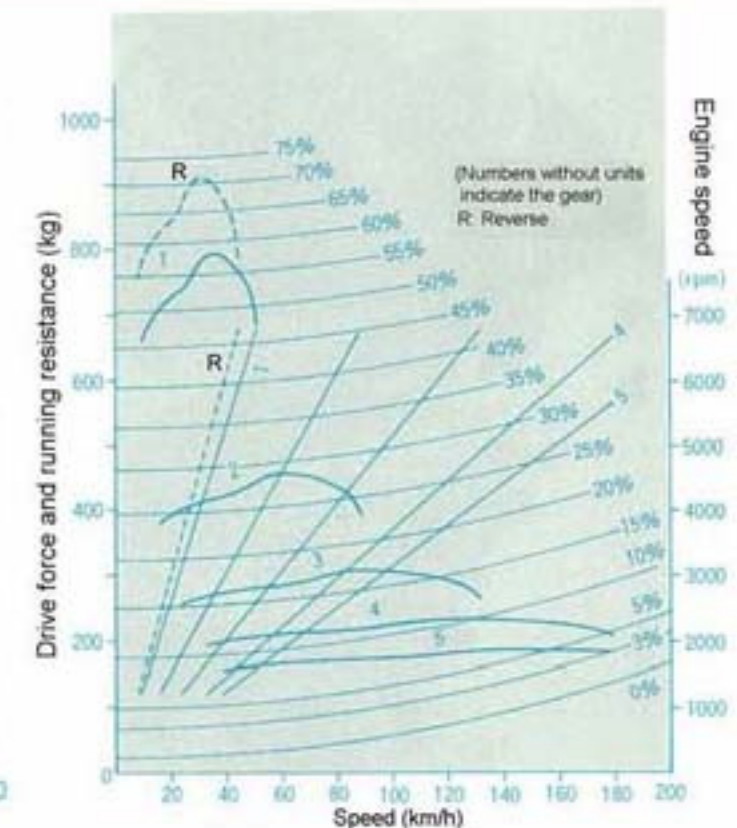

Driving performance curve Mark II Grande Hardtop (5 M/T)

Toyota twin-cam profiles

3T-GTEU/4T-GTEU

A turbocharged twin-cam high-performance engine

The 3T-GTEU, based on the Over-Head Valve (OHV) 3T-EU engine, is the first twin-cam engine in Japan fitted with a turbocharger. The 3T-GTE is the replacement for the 2.0 liter DOHC 18R-GEU, and its development targets were to drastically improve upon performance, fuel economy and packaging.

Due to the high power that results from the addition of the twin-cam cylinder head and the turbo, the thermal loading and combustion pressures increased. As a result of this, for rotating and reciprocating parts, vibration resistance strengthening measures greater than those for a twin-cam were scrupulously applied.

In addition, with the increased engine speed and higher output due to the turbo, an appropriate supply of fuel is required at high engine speeds, making it necessary to have a fuel system that can cover a wide range. As for the range required, from the very small injection quantity required when idling, to the large injection quantity required at high engine speeds, the appropriate injection volume is possible due to the adoption of high capacity injectors and current control drive system.

The CT20 turbocharger is made by Toyota, and it has a maximum speed of 110,000 rpm. The CT20 is also used on the 2L-T diesel engine. The only common feature in both applications is the bearing housing that supports the rotating shaft. The turbine housing and compressor housings, both of these being items that decide the characteristics of the turbocharger, are original to this application, and they have been designed according to the performance targets of the 3T-GTEU.

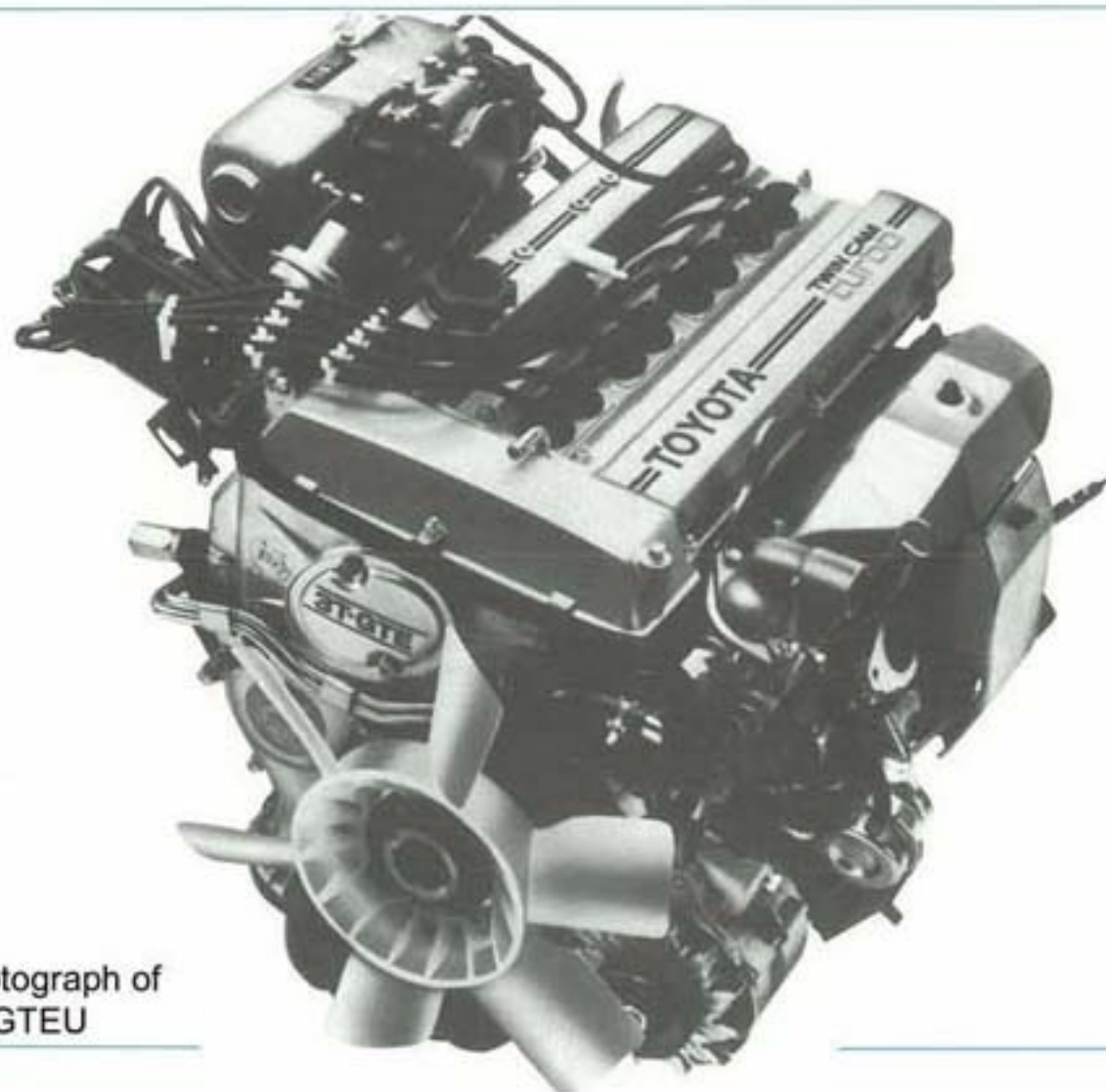

Photograph of 3T-GTEU

Celica Liftback GT-TR



3T-GTEU and 4T-GTEU engine specifications

Type	Liquid-cooled, Turbocharged, In-line DOHC 4-cylinder
Displacement	1770 (1791)
Bore x stroke (mm)	85 (85.5) x 78
Compression ratio	7.8
Power (ps)	160/6000
Torque (kgm/rpm)	21.0/4800

Specifications in brackets are for the 4T-GTEU

Chronology

Sep. 1982	Newly released, fitted to Carina, Celica, Corona
Nov. 1982	4T-GTEU fitted to Celica (limited prod.) FIA Group B official vehicle
May 1983	Turbocharger of 3T-GTE changed to water cooled type

Double-roller chain camshaft drive

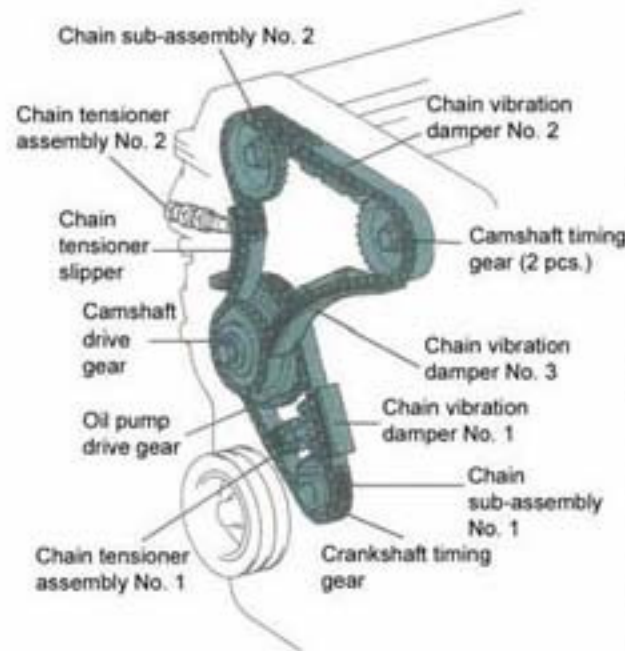

Because development of the turbocharger took place alongside development of the engine, the technological strengths of each could be made to align. Many turbocharger prototypes were produced to achieve reduced turbo lag (the delay before the turbocharger begins to work), and to ensure that the turbocharger is effective at high engine speeds. From these, the optimum turbocharger, the one that achieved the target performance, was selected for production. All involved in development of the 3T-GTE aspired to see it used for motorsports, and the 4T-GTE, with a 0.5 mm larger bore and displacement of 1791 cc, was developed concurrently for limited production.

The 3T-GTEU has adopted the knock control system and twin plugs (each cylinder has 2 spark plugs). The KCS (See page 21) achieves optimum ignition timing, and the twin plugs shorten the flame propagation period; both of these contribute to improved performance and fuel efficiency. The camshafts of the 3T-GTEU are driven by a two-stage roller chain. This arrangement, shared with the 4T-GTEU, was chosen to provide a reserve of strength because the 4T-GTEU serves as the base for the 4T-GT race/motorsports engine. The development of the 3T-GTEU started

with the aim of surpassing the performance of the 18R-GEU, and improving upon the fuel economy of its base engine, the 3T-EU.

Turbocharger

The turbine spins at high speed due to the exhaust gas, compressing the air to the cylinders using a compressor mounted on the other end of the same shaft. This is a form of supercharging, and it is used to obtain a greater amount of performance than otherwise would be obtained from an engine of a given displacement. The turbocharger makes use of energy in the exhaust gas that would normally be discharged into the atmosphere as heat. Because the output of a large engine can be obtained with a small engine, turbochargers are also used for engines such as those in sports cars and race cars, where high power is desired in addition to the lower weight and improved fuel economy.

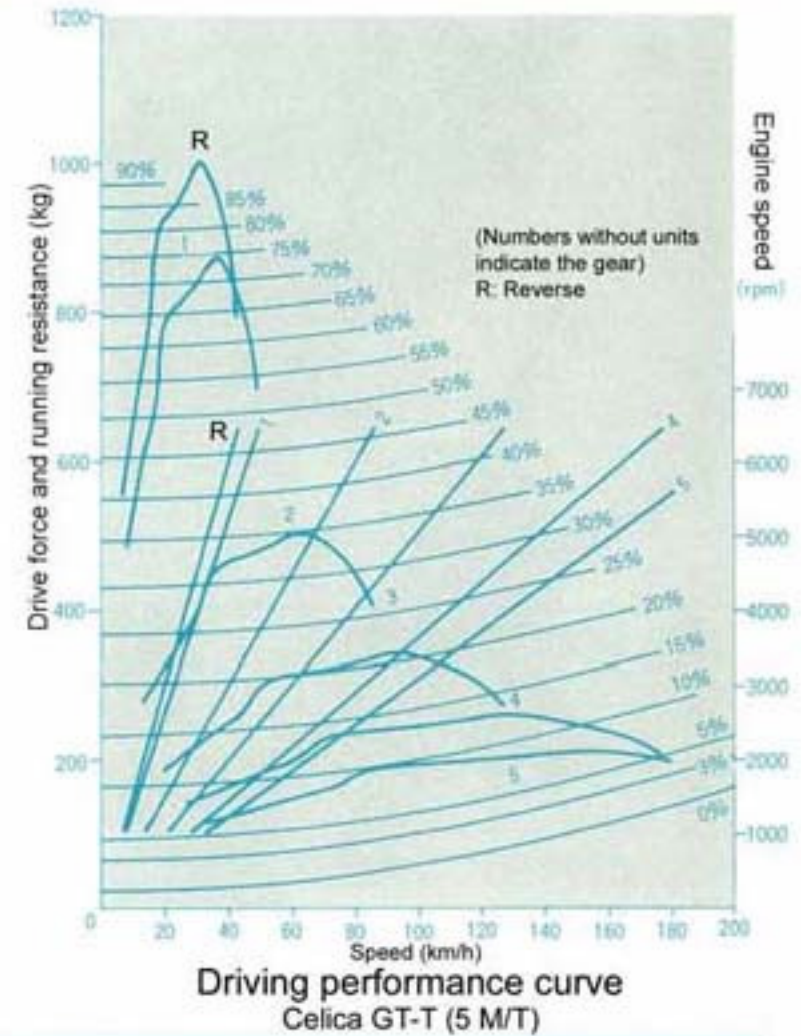
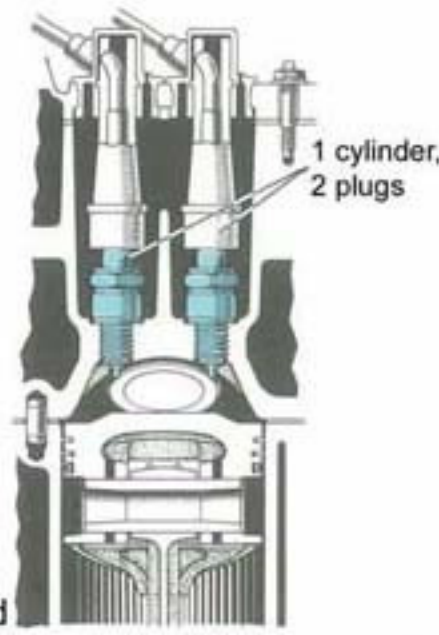
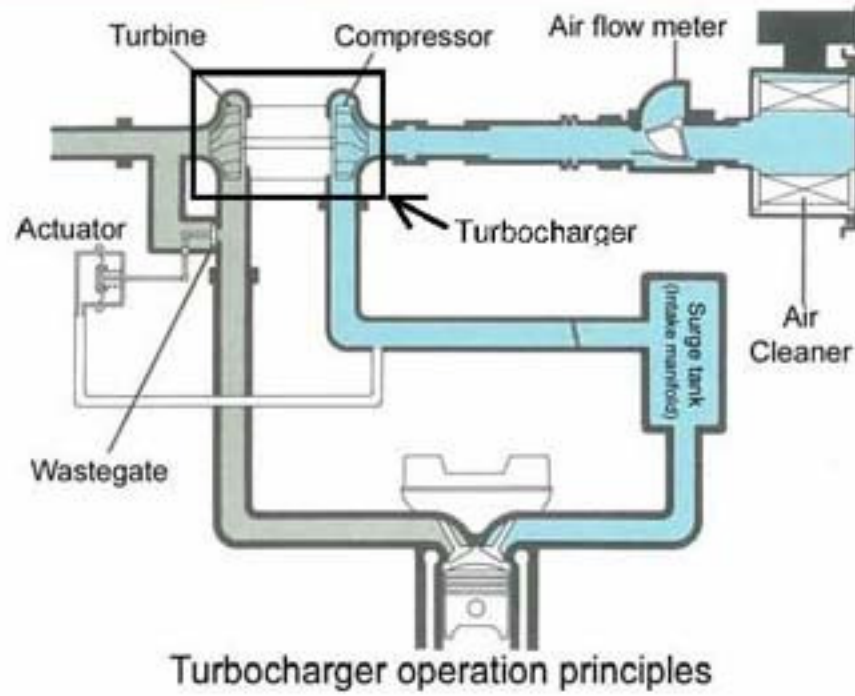
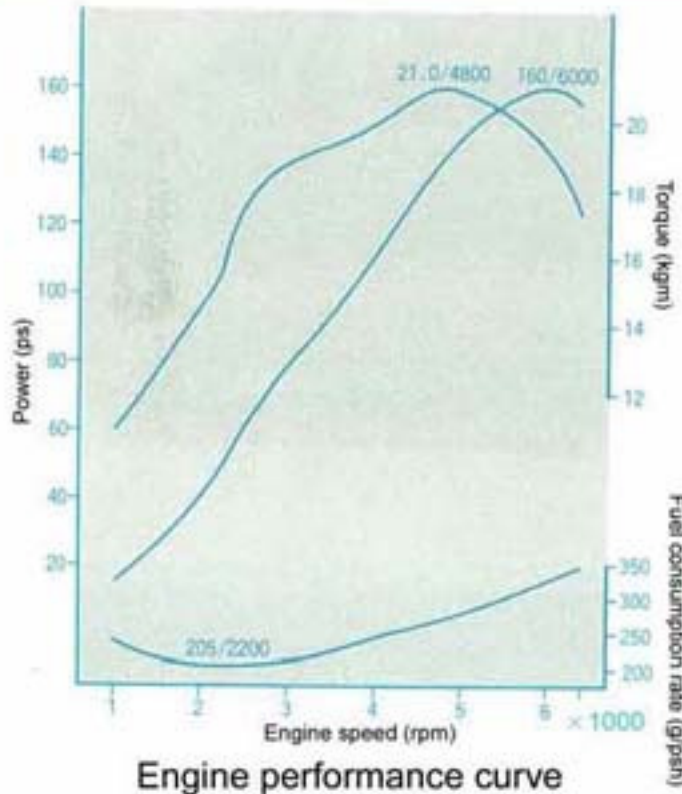

Twin-plug cylinder head

Driving performance curve Celica GT-T (5 M/T)

Toyota twin-cam profiles

4A-GEU/4A-GELU

Compact, lightweight and widely used

The 4A-GEU, a 4-valve twin-cam unit based on the 3A engine, starts the LASRE series and is the successor to the Toyota mass-production twin-cam familiar to all, the 2T-GEU.

The 4A-GEU was developed with the aim being to achieve high power and excellent response, adopting a cylinder head with 4 valves per cylinder. The cylinder head is made of an aluminum alloy that excels in heat transfer, and it also reduces intake

resistance via its increased valve opening area and port area, greatly improving intake efficiency at high engine speeds. Due to the adoption of the 4 valve design, higher power output and higher engine speeds (130 ps/6600 rpm) are possible than the 2T-GEU.

The valves are directly operated by the camshafts, providing the following

advantages (1) a simplified structure, reducing weight, (2) the valve clearance change is small, (3) the valvetrain reliability is high, and (4) the height of the valvetrain is less than the rocker-arm type. In addition, wear resistance is improved by applying a special alloy to the valve face, and a structure is adopted to improve the ease of valve adjustment by allowing shims to be exchanged without removing the camshafts, improving serviceability and reducing required maintenance.

Via the use of FEM analysis, the weight of the cylinder block, crankshaft, etc. has been kept low, while also maintaining high rigidity. As a result, the 4A-GEU engine (123 kg) is 23kg lighter than the 2T-GEU at the same time achieving a noise reduction of about 4dB.

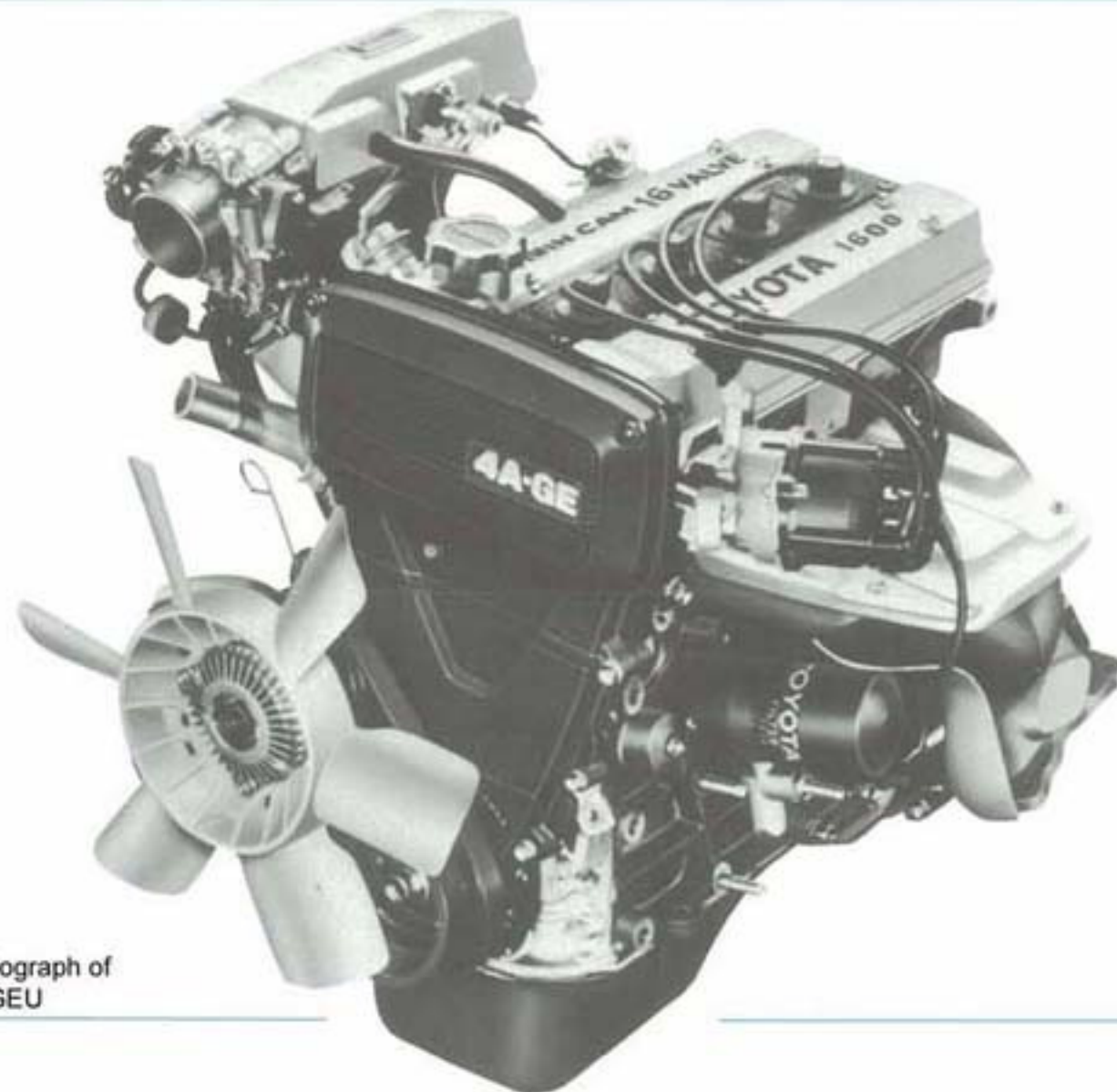

Photograph of 4A-GEU

Toyota MR2
1600 G-Limited



4A-GEU and 4A-GELU engine specifications

Type	Liquid-cooled, In-line DOHC 16-valve 4-cylinder
Displacement	1587
Bore x stroke (mm)	81 x 77
Compression ratio	9.4
Power (ps/rpm)	130/6600
Torque (kgm/rpm)	15.2/5200

Chronology

May 1983	4A-GEU newly released, fitted to Corolla Levin/Sprinter Trueno
Jun. 1983	4A-GELU fitted to Carina
Aug. 1983	4A-GEU fitted to Celica
Oct. 1983	4A-GEU fitted to Corona
Jun. 1984	4A-GELU fitted to MR2, new release
Oct. 1984	4A-GELU fitted to Corolla FX
Oct. 1984	4A-GLEU fitted to Corolla/Sprinter

4A-GEU engines suitable for transverse mounting in a vehicle receive the 4A-GELU designation. This transverse version is installed to the first Japanese mid-engined car, the MR2, the front-wheel drive Corolla and others.

D type EFI is used for the fuel system of the 4A-GEU (4A-GELU). The absolute pressure within the intake manifold is detected using a MAP sensor (vacuum sensor); using this, the fuel volume is determined. The piezoresistive effect of silicon crystal is used (the characteristic of the electrical resistance of the crystal changing according to pressure) by the sensor, and computer control is performed.

Equipping a vehicle with this system has the merit of resulting in reduced weight. The 4A-GEU (4A-GELU) initially began its development as a 2-valve design, and after approximately a year of evaluation, the change was made to a 4-valve design. The reason for this is the excellent power output at high engine speeds, and of course the good combustion efficiency, plus the good fuel efficiency of the twin-cam 4-valve design. The reason for this is the excellent power output at high engine speeds, and of course the good combustion efficiency, and good fuel efficiency of the twin-cam 4-valve design.

For the 4-valve design, even with greater valvetrain frictional losses due to the increased number of valves, this is offset by reduced pumping losses (parasitic losses during intake and exhaust), resulting in the overall efficiency improvement.

After deciding on the four valve design for the 4A-GEU, 3 sets of prototypes were produced. Additionally, among other modifications, the crankshaft was changed from a cast to a forged item, and the number of flywheel installation bolts was changed from six to eight to improve durability and reliability, and to prepare the engine for production.

4-valve design

For this type of multivalve design, there are a total of 4 valves, 2 intake valves, and 2 exhaust valves. Increased engine power output is achieved by increasing the amount of air drawn in on each intake stroke; the 4-valve design has an advantage due to the large area of its air passages. Additionally, on a 4-valve design, the low individual weight of each valve helps to make high engine speeds possible.

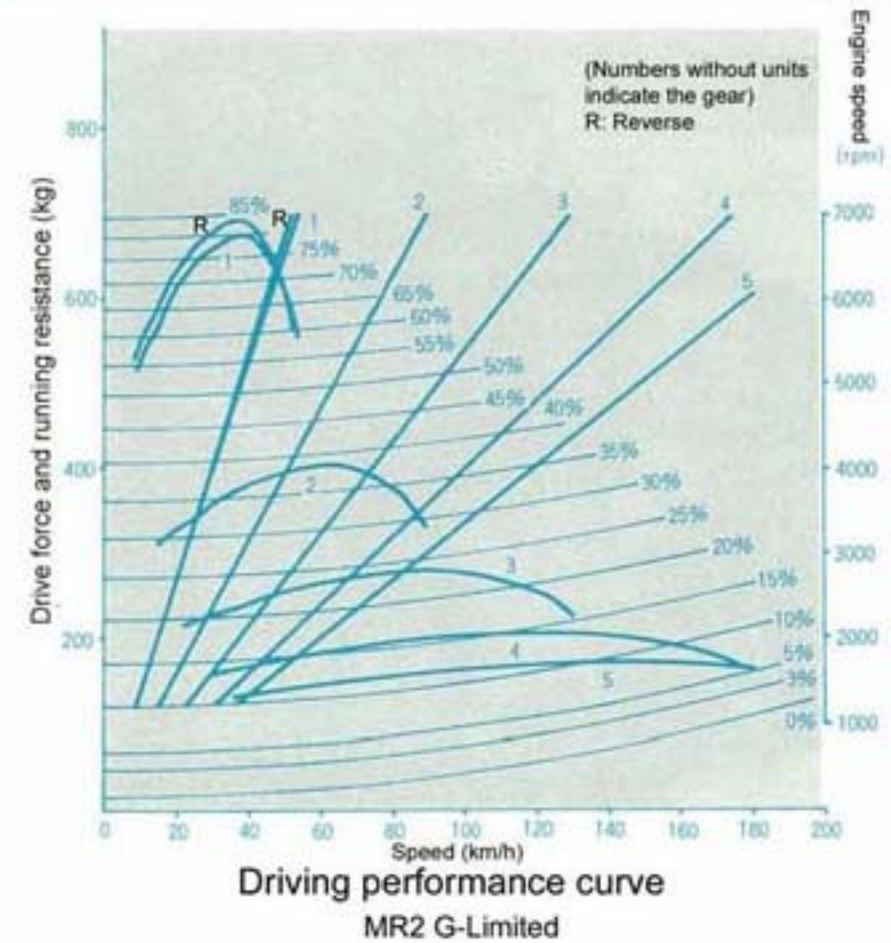
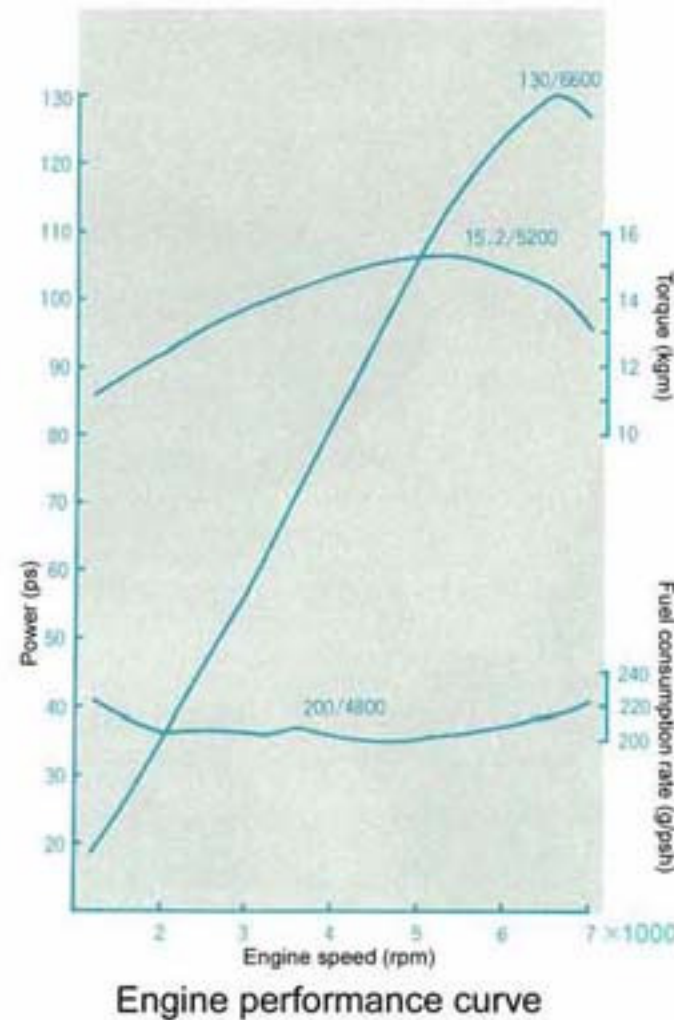
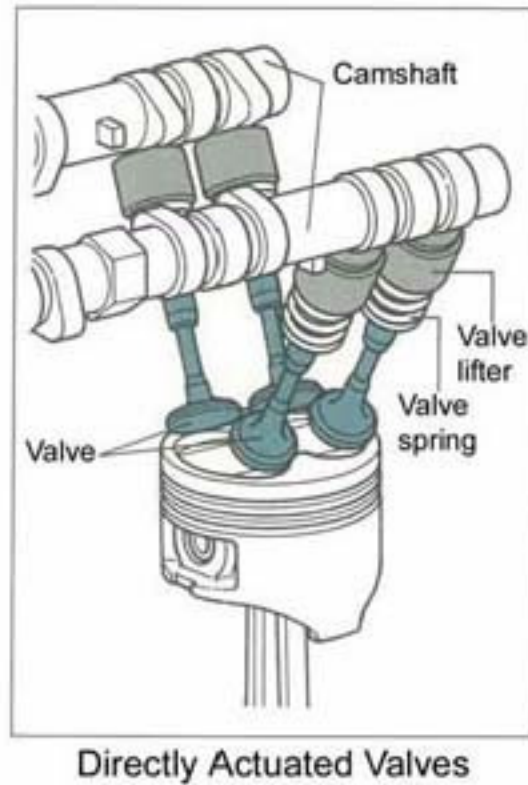
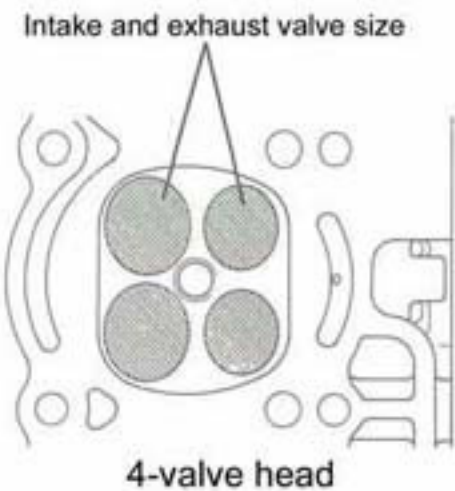
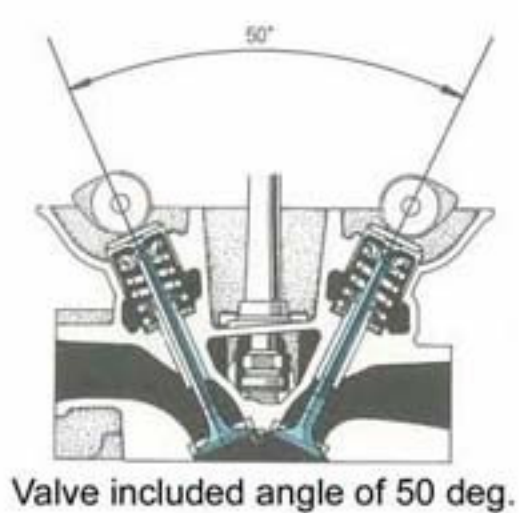

Toyota twin-cam profiles

3S-GELU

A twin-cam developed exclusively for FF vehicles

The 3S-GELU is a 4-valve twin-cam engine developed only for front-wheel drive (FF) vehicles. The development aim of this engine was to achieve high performance and fuel efficiency that surpasses that of competitive vehicles, superior response in accordance with accelerator pedal operation, and a lightweight compact layout that is suitable for an FF vehicle.

The 3S-GELU is based on the well received 2S-ELU fitted in the Camry Vista. In order to achieve high engine speeds and high power, a DOHC cylinder head design has been adopted and the bore and stroke have been modified. The cylinder head uses a crossflow design for the flow of the intake and exhaust gasses.

Together with the adoption of the 4-valve design, a 2 mm larger bore than the 2S-ELU enables the larger diameter valves that are fitted, and a 4 mm shorter stroke reduces piston speed, enabling high engine speed operation. To provide high speed engine output, almost straight intake and exhaust ports are used. To accommodate the high power output, the cylinder block and connecting rods have been strengthened, and a forged crankshaft has been adopted, among other measures.

As a result of the items above, this engine obtained the top efficiency among 2 liter DOHC production engines in Japan. Also, in consideration of usability in common operating ranges, the 3S-GELU also adopted T-VIS and a smallish amount of valve overlap to ensure torque at low engine speeds. For engine control, the TCCS system has adopted a 12 bit processor to control fuel injection (EFI) and ignition timing (ESA). A programmed independent injection method is used for EFI control.

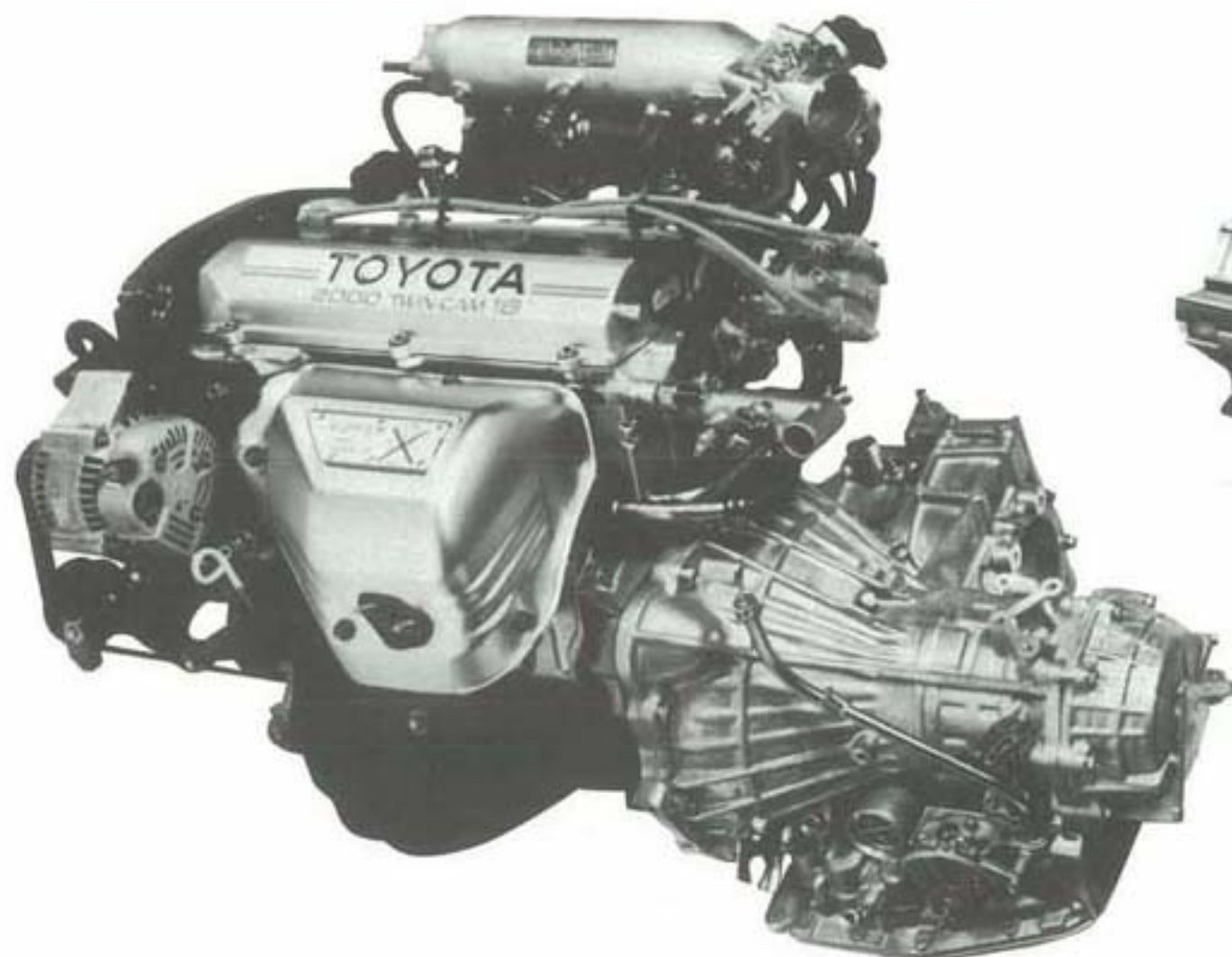

Vista Twin Cam 2000



3S-GELU engine specifications

Type	Liquid-cooled, In-line DOHC 16-valve 4-cylinder
Displacement	1998
Bore x stroke (mm)	86x86
Compression ratio	9.2
Power (ps/rpm)	160/6400
Torque (kgm/rpm)	19.0/4800

Chronology

May 1984 3S-GELU newly released, fitted to Camry, Vista

Injection timing as load increases

Based on the amount of intake air, engine speed and other items, the volume of fuel required is calculated and is injected for each cylinder at the optimum timing. In addition, superior response, good fuel efficiency and excellent drivability were obtained by using ESA to control the ignition timing precisely according to engine operating conditions.

Tangibly, in the Camry and Vista, while able to manage a 0 to 400 m acceleration time of just 16.7 seconds, the 3S-GELU can still achieve a 10-mode fuel economy rating of 12 km/l, an achievement that sets it at the top for fuel economy among 2 liter DOHC vehicles.

Furthermore, the 3S-GELU, at a weight of 143 kg, is an exceptionally light 2 liter DOHC engine. This is advantageous, resulting in a nimble driving FF vehicle that is easy to operate. Making these achievements possible are the lightweight 2S-ELU base engine, the intake manifold, flywheel, throttle body and other parts that were modified exclusively for the 3S-GELU, and careful design consideration.

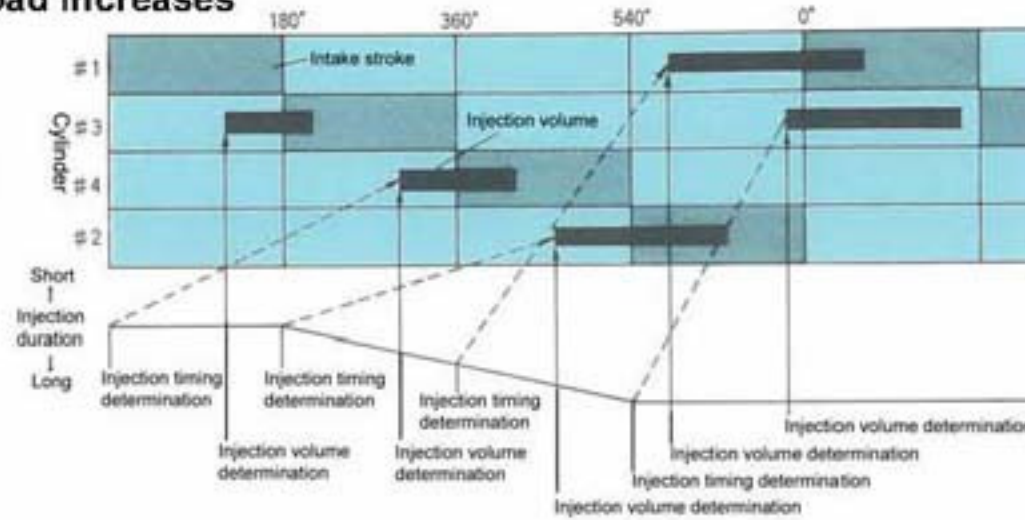

As covered to this point, the 3S-GELU is a twin-cam 16-valve with a suitable mix of unrivalled power at high engine speeds and fully developed usability; it is a twin-cam appropriate for a new era.

Sequential fuel injection

For sequential injection, the necessary amount of fuel is injected every cycle for each cylinder. Because the amount of fuel injected to each cylinder is always based on the latest calculated value, this system performs excellent control of the air-fuel ratio during transitions. This programmed independent injection method used by Toyota also selects the best injection timing under all driving conditions.

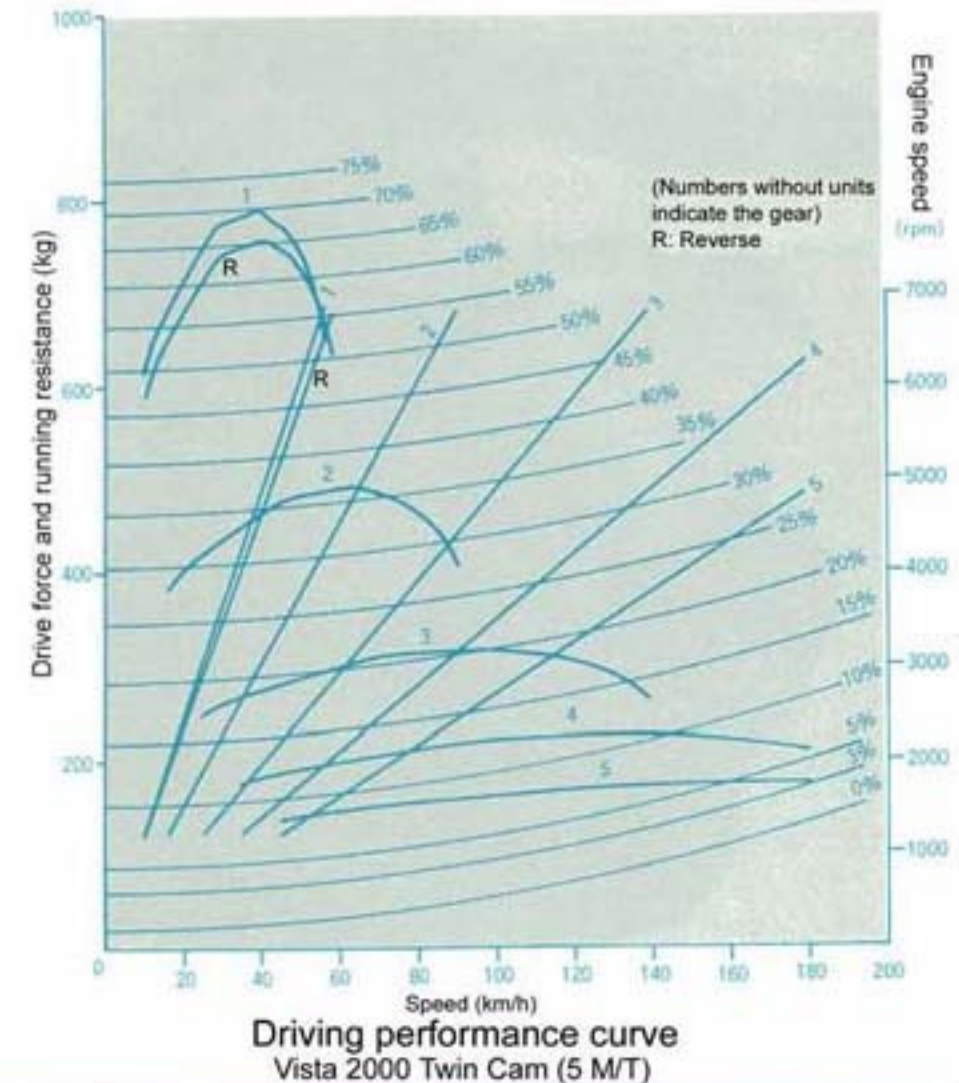
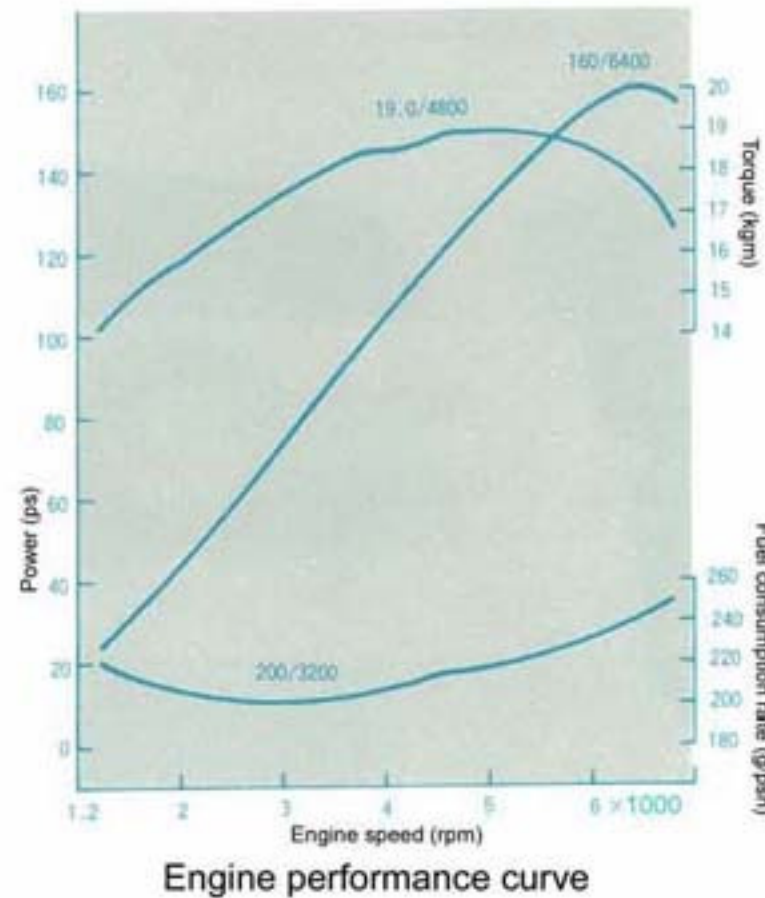
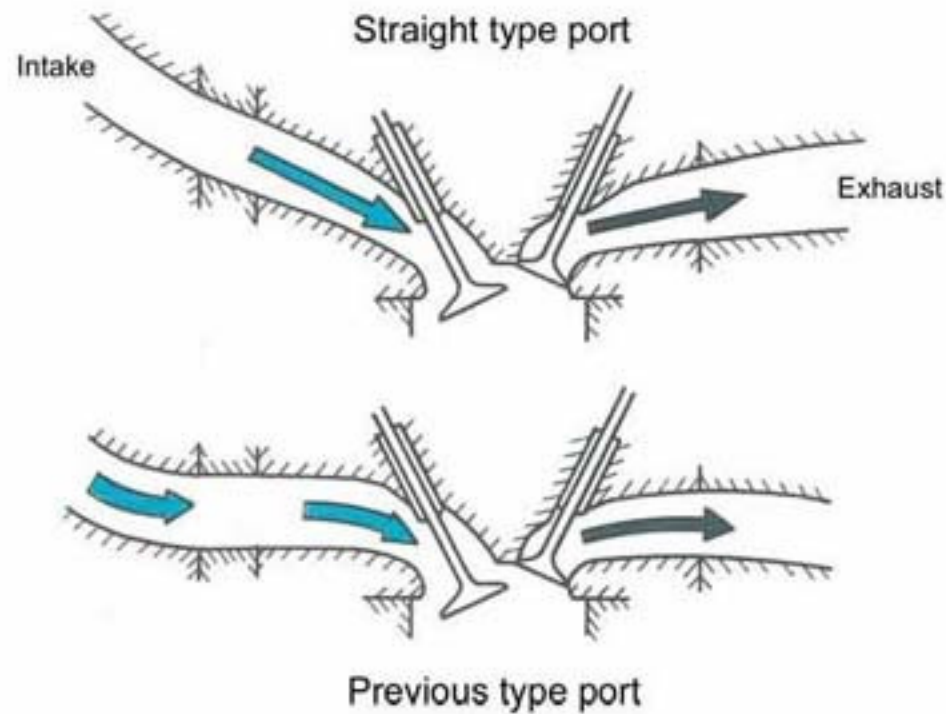

Toyota twin-cam profiles

LASRE α -X

Advanced development aiming for optimum control via variable mechanisms

The LASRE α -X is a 1G-GEU based advanced development engine which brings together some variable mechanisms to perform coordinated and optimum engine control. The mechanisms that are used are (1) variable valve timing (2) variable intake runners (3) variable engine displacement (4) twin turbochargers with an intercooler and (5) distributorless ignition.

Variable valve timing

Variable valve timing continuously changes the timing of both the intake and exhaust camshafts, achieving optimum valve opening and closing timing to suit the operating conditions of the engine. Torque and fuel economy can be improved over all engine speed ranges.

Variable intake runners

For the variable intake runners, the 6 cylinders are divided into two groups of 3 intake runners, one for cylinders 1, 2, and 3, and the other for cylinders 4, 5 and 6. In addition, a control valve is placed between these two groups of runners. When the intake control valve opens, the two runners are connected, and mid range engine speed torque is improved. When the valve is closed, torque peaks for low and high engine speeds.

Accordingly, the valve is opened and closed based on engine speed, aiming to enhance both overall torque and engine efficiency. The variable intake runners are an effective system to improve torque using the intake pulsations. The pulsations of the variable intake runners provide an additional improvement on top of that provided by the supercharging of the turbocharger. In addition, by using the pulsations at low engine speeds, when turbocharger effectiveness is low, this system also improves torque.



Toyota FX-1
(Tokyo Motor Show reference exhibit)

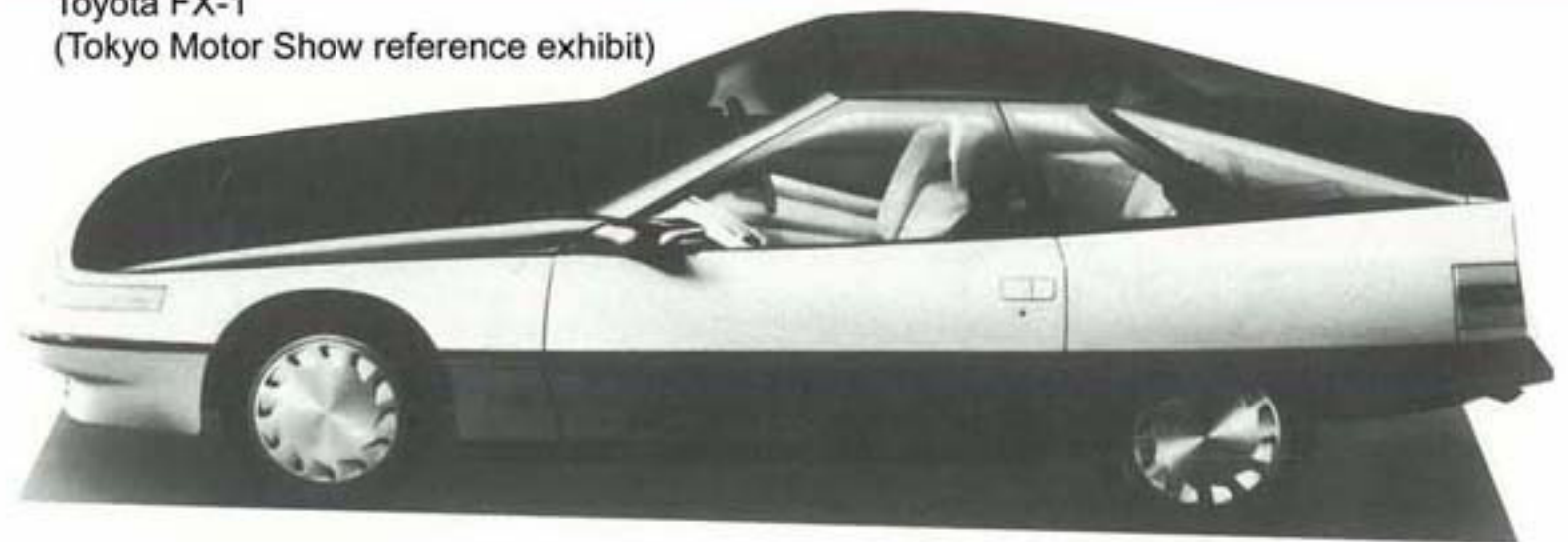

LASRE α -X engine specifications

Type	Liquid-cooled, Turbocharged, In-line DOHC 6-cylinder
Displacement	1988
Bore x stroke	75x75

Chronology

Oct. 1983 Reference exhibit of LASRE α -X and 1G twin-cam, twin-turbo engines at the 25th Tokyo Motor Show

Variable engine displacement system

The variable displacement system, when idling, at low loads or when a large amount of power is not required, stops the operation of cylinders 4, 5 and 6 to improve fuel economy. When the engine load is low, the engine is operated using 3 cylinders (1, 2 and 3 only). These 3 cylinders operate at a higher load than they otherwise would, and because of this, efficient driving is possible. The method used to stop operation is to cut off the air and fuel.

The LASRE α -X combines twin turbos and an intercooler. The advantage of using two turbochargers is that turbocharger effectiveness can be brought out from low engine speeds; and yet turbocharger effectiveness is still possible at high engine speeds. With the small type turbo used, the turbine has a small inertial mass. As a result, even at low engine speeds when the exhaust energy is small the turbine spins smoothly, and compressor drive force is possible.

The intercooler is a heat exchanger used to cool the air taken into the cylinders. The temperature of this air rises due to it

having being compressed by the turbocharger. When the temperature of the intake air rises, the temperature of the compressed mixture also rises, resulting in an increased chance of knocking. These faults are addressed by the use of an intercooler, resulting in improved performance. Among Toyota vehicles, a liquid cooled intercooler is used for the M-TEU engine of the Soarer (6 cylinders, 1988 cc, max power 160 ps), improving efficiency and reliability, and receiving a favorable response.

Especially important considerations during development of the LASRE α -X were minimizing maintenance, and ensuring

failsafe operation of the engine (including mechanisms to ensure overall safe operation in the event of the failure of a part of one of the components).

One example of a system that reduces maintenance on the ignition system is the computer controlled distributorless ignition system that is used to improve ignition characteristics with the goal of achieving stable combustion.

The control of the variable mechanisms, and overall integration of their functions for the engine has also been considered from a software point of view, along with failsafe operation.

Variable valve timing system

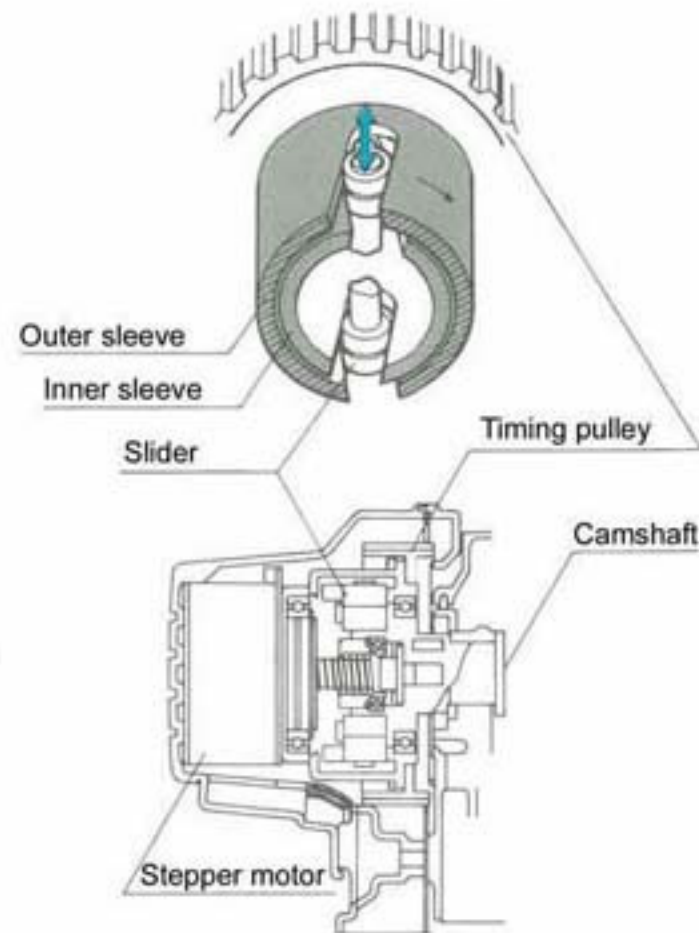

Variable intake system

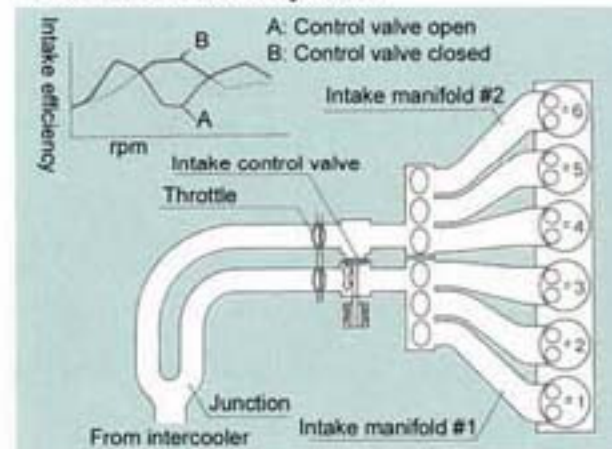

Variable displacement system

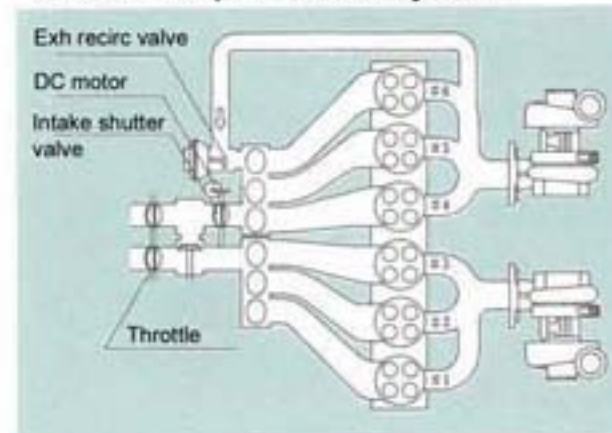

Intercooled turbocharger system

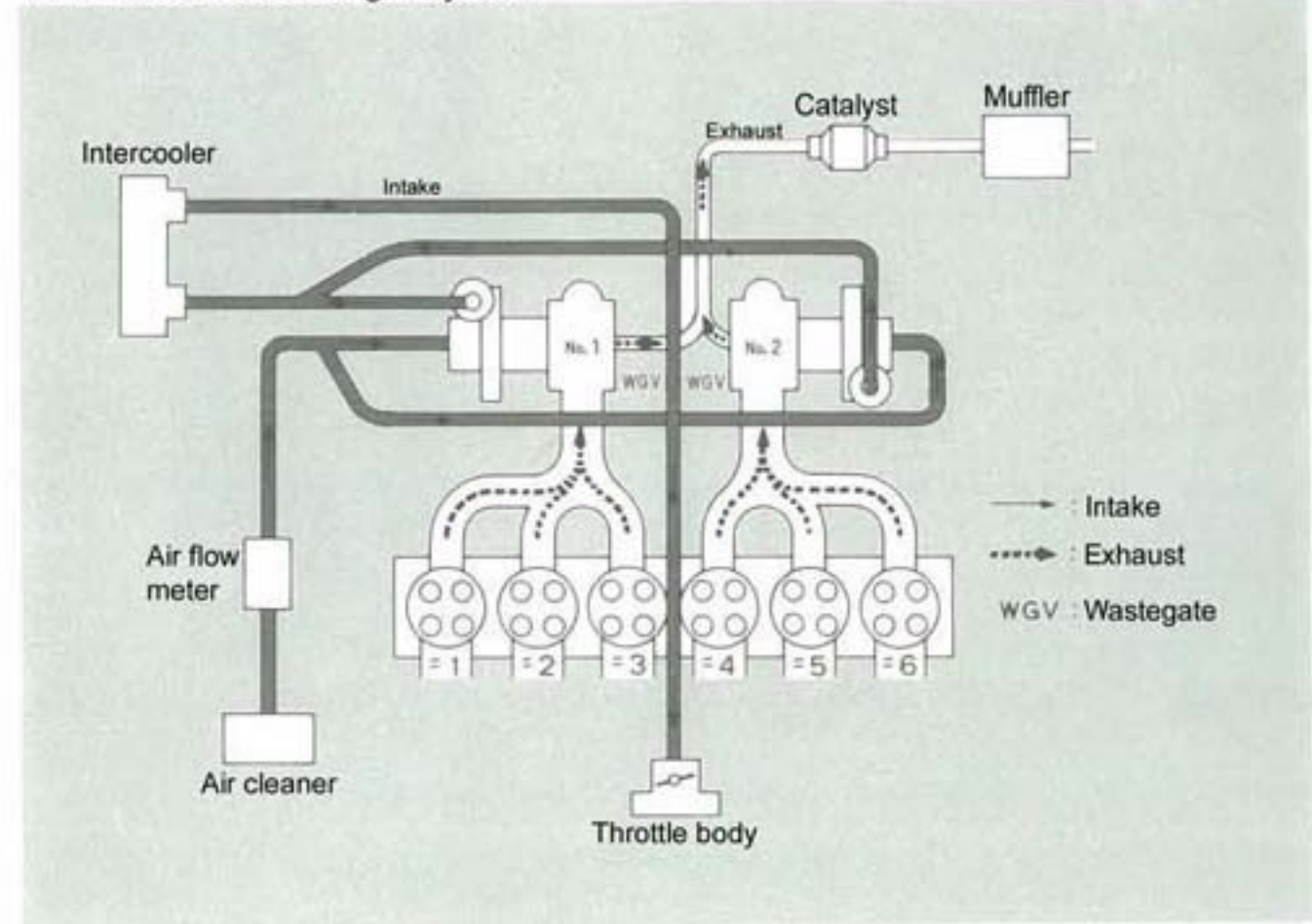

Toyota twin-cam technology profiles

Advanced Technologies

The high performance and improved fuel economy of Toyota twin-cam engines is enabled by the adoption of mechanisms that match the engine requirements, including TCCS (Toyota Computer Controlled System) which performs centralized control of functions such as fuel injection and ignition timing.

In addition, the introduction of exotic materials, such as the use of ceramics for sensors, is helping to achieve the goal of optimal engine control.

Platinum Spark Plugs 100,000 km Longevity without Adjustment

Tips of platinum are welded to the ends of the center and ground electrodes, ensuring a lifespan of at least 100,000 km without adjustment. Also, the center electrode can be made finer, improving the ignition characteristics of the spark plugs. Neither gap adjustment nor removal for inspection is necessary.

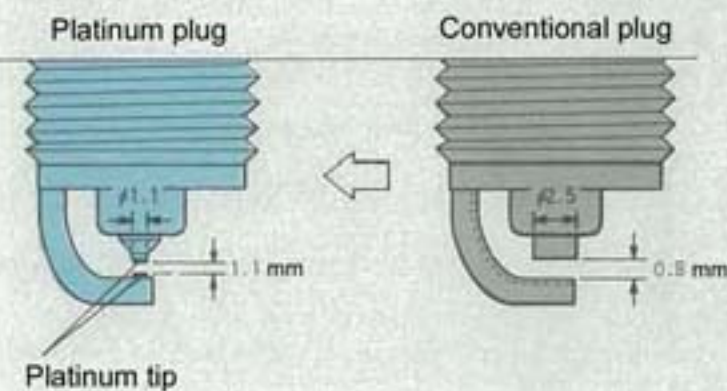

L-type EFI and D-type EFI

The optimum match of engine to fuel system

EFI, or Electronically (controlled) Fuel Injection, is a system that supplies each cylinder with the optimum amount of fuel for the engine operating conditions. Among other things, EFI is effective at improving engine output and fuel economy, and making the treatment of exhaust emissions easier.

For Toyota, there are two different methods of measuring the amount of air entering an engine. One type uses an airflow meter and is referred to as EFI-L, and the other, EFI-D, measures the absolute pressure in the intake manifold. The type of injection selected for an engine is determined according to engine characteristics and other reasons, in order to achieve a fuel injection system that is the best match with the engine.

Electronic Spark Advance (ESA) system High precision ignition timing control

The Electronic Spark Advance (ESA) system has a map of the optimum ignition timing for the engine operating conditions stored in the engine control computer. Based on the signals from the sensors, the computer determines the engine operating conditions (engine speed, intake air volume, coolant temperature, etc.), selects the optimum ignition timing and sends a current cut signal to the igniter to control ignition timing. Precise ignition timing control to suit the engine operating conditions is possible, improving fuel economy and power output.

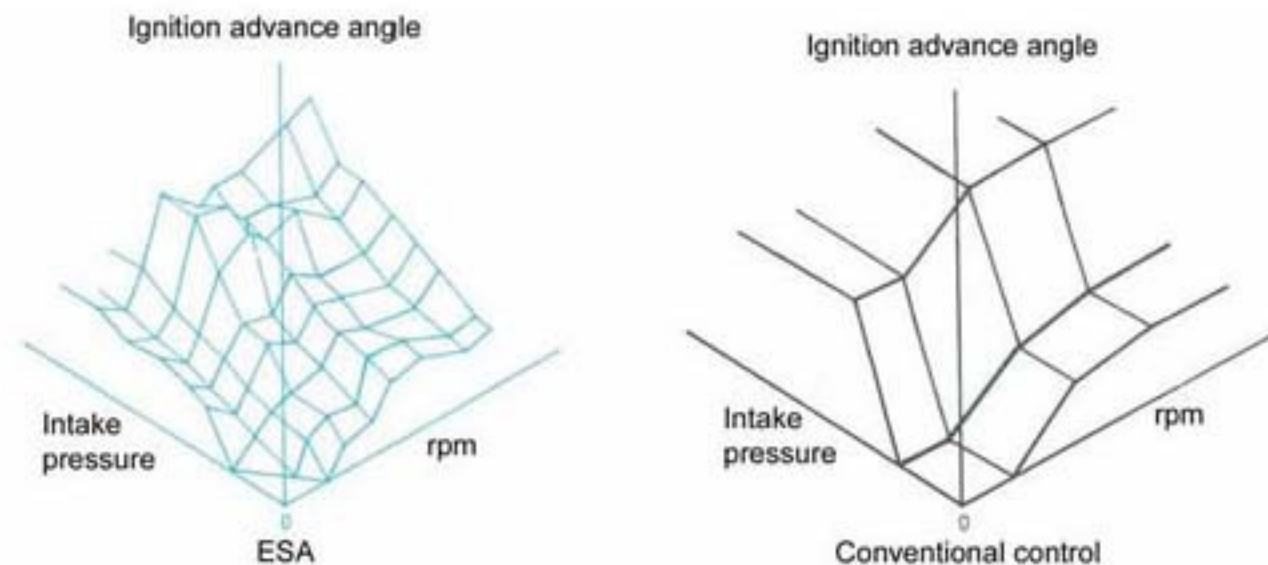

Pentroof combustion chamber Improved combustion efficiency

The cross-section of a pentroof combustion chamber is roof shaped. Because the spark plug is centrally located and the time required for combustion is short, the anti-knock properties of the pentroof design are excellent. This makes the use of a high compression ratio possible, improving combustion efficiency.

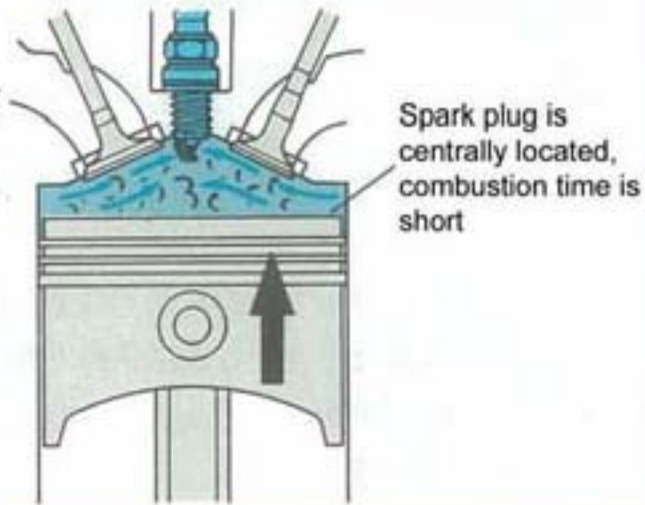

Knock Sensor - Putting ceramics to use

The knock sensor detects the mechanical vibration of the engine that results from knocking. Using the piezo effect of its lead zirconate (PbZrO₃) ceramic element, the sensor produces an electromotive force in response to the vibration. Toyota knock sensors are the resonant frequency type that produces a strong electromotive force in the knock vibration range.

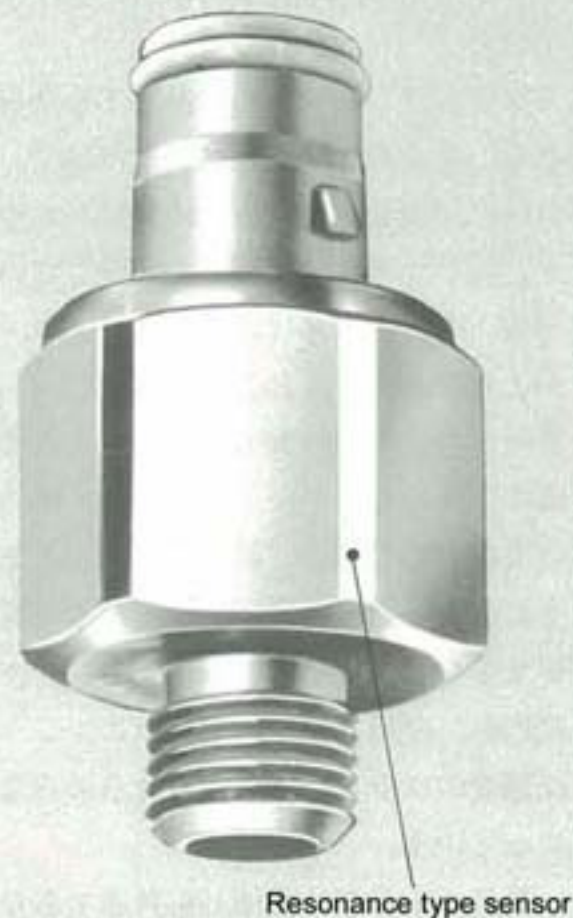
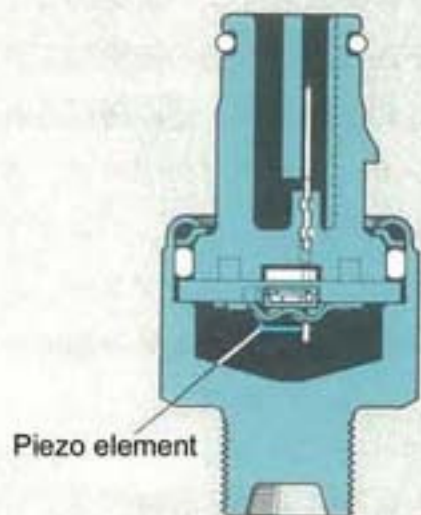

Mechanisms used for Toyota twin-cam engines

Applicable engines

Mechanism	Twin-cam engine					
	6M1GEEU	5M1GEEU	3S1GEEU	1G1GEEU	3T1GTEU	4A1GEE(L)U
Timing belt camshaft drive						
Timing chain camshaft drive						
4-valve/pentroof combustion chamber						
Hemispheric combustion chamber						
Multispheric combustion chamber						
Directly actuated valves						
Valve lash adjusters						
T-VIS						
EFI-L				①		
EFI-D						
Water cooled turbocharger						
Dual surge tank						
Platinum spark plugs						
Electronic Spark Advance system (ESA)						
Knock Control System (KCS)						
Dual spark plugs						
Oil cooler						②
Diagnosis (self-diagnosis function)						

① Only for Crown

② MR2 with automatic transmission

Toyota twin-cam technology profiles

Production Technology for Mass Production

Toyota twin cam engines are produced at the Kamigo and Shimoyama plants, and also by Yamaha Motor Co., Ltd. There are 3 basic merits of the Toyota twin-cam production method.

1. Conventional and twin-cam engines are both produced on the same line.
 2. Large-scale introduction of automation.
 3. Introduction of new industrial technology.
- These merits make it possible not only to supply a large volume of twin-cam engines, with their high efficiency and good fuel economy, they also ensure high quality and consistency.

3 different engines produced together

Using the line for the 4A-G engine, let's have a look at the Toyota twin-cam

production method. On this line, three types of engines, the 2A (4 cylinder SOHC, 1295cc), the 4A (4 cylinder SOHC, 1587cc) and the 4A-G (4 cylinder twin-cam 4-valve (DOHC), 1587cc) are produced. Among the 2A, 4A, and 4A-G, there are many differences. There are cylinder head shape differences due to single-cam and twin-cam configurations, different cylinder block bore diameters, and different crankshaft materials, shape, stroke etc. In order for multiple types of engine to be produced one after the next on one line, various items such as automation and an appropriate supply of parts to the line are required.

So, let's take a look at how this line can produce not only conventional engines, but also twin-cam engines.

Machining of the cylinder block is fully automated. While the 4A and 4A-G are alike, only the machining of the bore for the 2A is different from that of the 4A. After the machining of the engine block is finished, a painting robot is used to apply paint to the surface of the block. The robot applies one of two colors in accordance with the type of engine. The machining of the crankshaft is also fully automated. The 2A and 4A crankshafts are cast parts that can be produced one after the next on the same line, although the stroke is somewhat different. As for the 4A-G crankshaft, it is a forged part, and even though the shape is different and some of the manufacturing process is unique to it, it can still be produced together with the crankshafts for the 2A and 4A. As the lifespan of cutting tools used for the machining process is different for forged parts and cast parts, it was necessary to change the material used for the cutting tools. Overall, the crankshaft manufacturing process is optimized to enable the production of a highly accurate crankshaft that is suitable for a high power, high speed twin cam engine. The connecting rods are common for all three types, the shapes of the pistons for the three types are different, but the assembly of the piston and connecting rod sub-assembly has been standardized. Before assembly, the finished cylinder block, crankshaft and pistons (with connecting rods) are sent to the location where assembly of the bottom end of the engine is performed. Here, three different types of bottom end are assembled following one another on the same line,

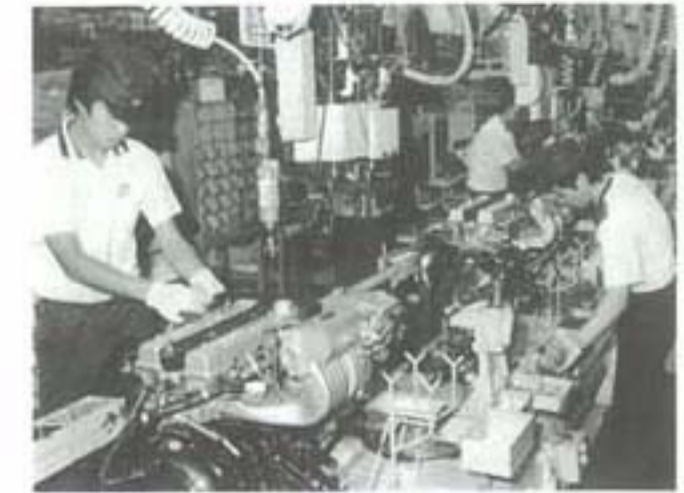

4A-G final assembly process

and the supply of parts is controlled to prevent an assembly mistake.

Automation of shim selection and improvement of precision

On the other hand, the cylinder head for the 2A and 4A single-cam and 4A-G twin-cam are each on their own fully automatic machining line are manufactured in advance and assembled. The main parts, the twin-cam 4-valve head and camshafts, and the smaller parts, the valves, valve springs, retainers, valve lifters, are brought together and assembled on the Head Subassembly line.

For this process, a production technique specific to a twin-cam cylinder head is used. This technique automates the thickness selection of the clearance adjustment shim used between the cam and valve lifter.

The purpose is to help improve accuracy, and to prevent mistakes that come from performing monotonous repetitive work.



Panorama of Shimoyama plant. The twin-cam 4A-G is produced here.