

# NISSAN



**R32 ENGINE MANUAL. CA18i, RB20E, RB20DE,  
RB20DET, RB25DE & RB26DETT**



# R32 SKYLINE

# SECTION **GI**

## GENERAL INFORMATION

### CONTENTS

HOW TO USE THIS MANUAL ..... GI - 2  
GENERAL PRECAUTIONS ..... GI - 7  
VEHICLE & UNIT IDENTIFICATION PLATE LOCATION ..... GI - 10  
CONSULT ..... GI - 11  
TIGHTENING TORQUE OF STANDARD BOLTS ..... GI - 12  
TOWING ..... GI - 13  
4WD INSPECTION & REPAIR PRECAUTIONS ..... GI - 15

## HOW TO USE THIS MANUAL

### MAINTENANCE OPERATION EXPLANATION

This manual describes important items for installation, removal, assembly, inspection, repair and failure diagnosis.

#### Caution:

A general description of a visual inspection and cleaning of disassembled parts has generally been omitted. However, when reusing the parts, make sure to perform visual inspection and cleaning as necessary.

### CONFIGURATION COMPONENTS, OPERATION CONTENTS & PROCEDURES

The configuration components, operation contents and procedures are shown after the title of each operation. Preparation standards and important operation points such as parts which can not be used again, tightening torque and lubrication locations are also indicated.

#### Configuration components & Operation contents

The operations for installation, assembly and disassembly are indicated by the part name. This description is used when the ideal procedure can not be determined or there are many types of components.

[Point] is used to indicate the operation procedures which are necessary.

#### Example: Front Axle disassembly & assembly

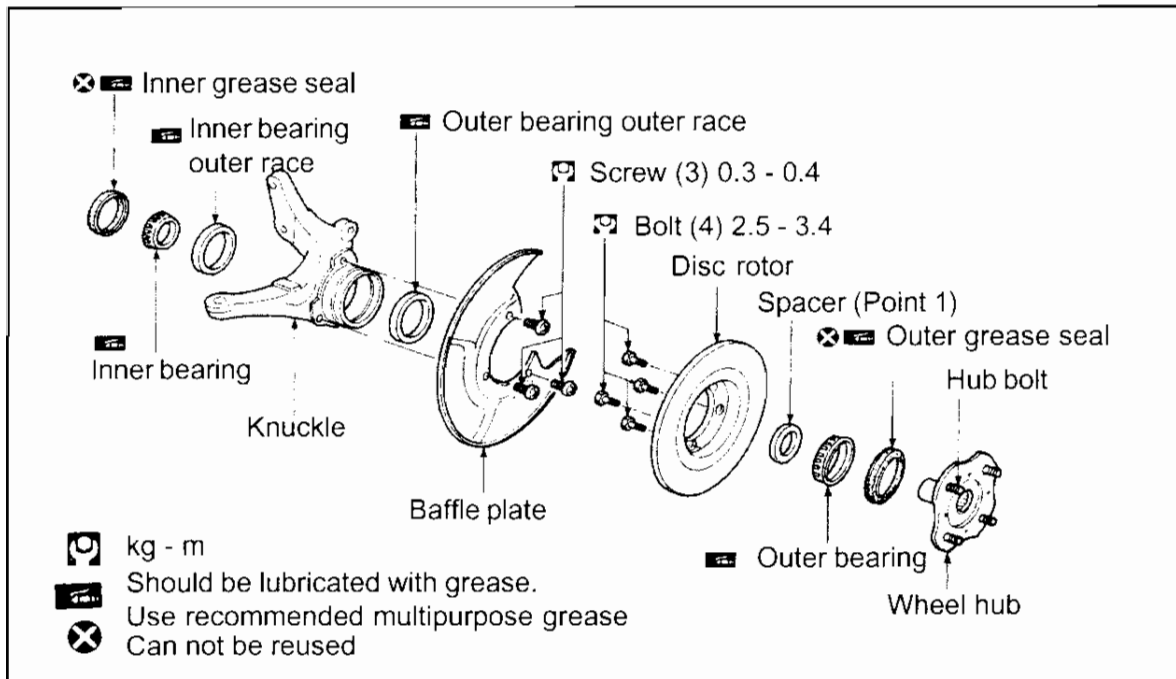

#### Unit definition

The unit of measure used in this manual for tightening torque is described in "SI measure (International unit)" and the units within { } is in meter unit.

Example: Tightening torque: 59 - 78 N-m {6.0 - 8.0 kg-m}

SI measure      Meter measure







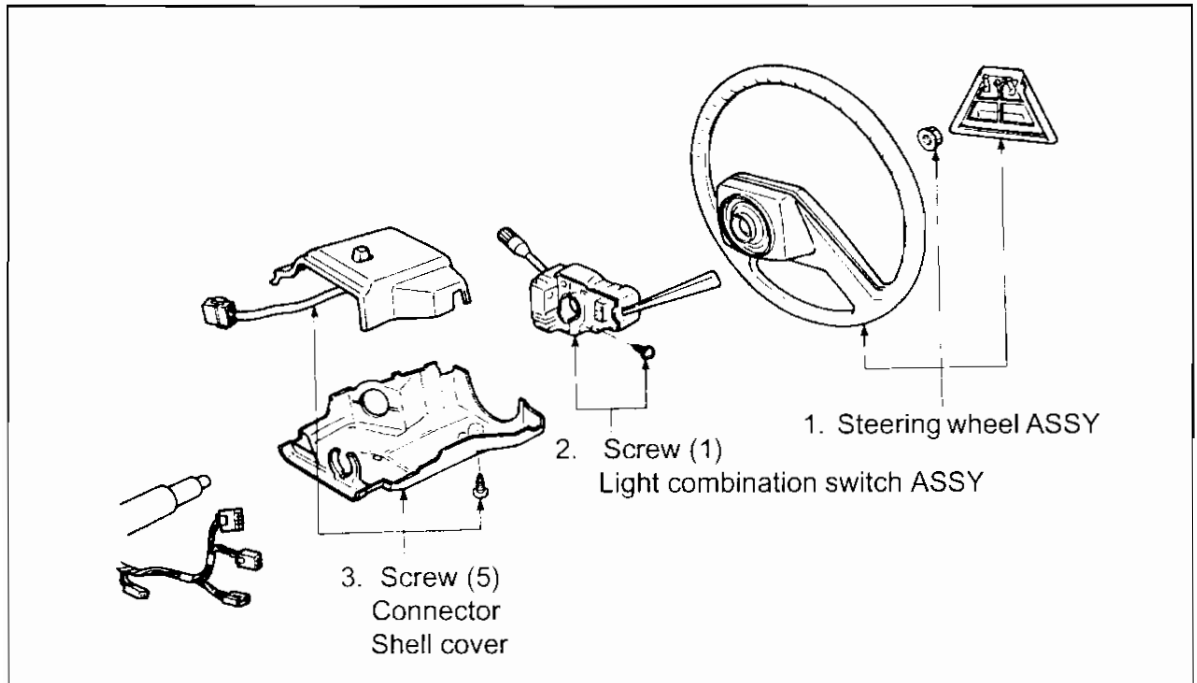

**STRUCTURAL PARTS DIAGRAM AND OPERATIONAL SEQUENCE**

The name of the parts required for the operations are shown. The operation sequence must be followed in the order shown.

Assembly is the reverse of disassembly except when otherwise indicated.

**Example 1: Light combination switch ASSY installation and removal**



SYMBOLS	DESCRIPTION
	Operation where the torque should be checked and the standard torque value that should be used. When X to Y N.m (kg-m, ft-lb) is indicated, the standard tightening torque is the mean value.
	Should be lubricated. Indicate a type of grease
	Parts that can not be reused
	Should be lubricated with oil
	Sealing point
	Select proper parts
	Adjust parts
	Part need to be checked visually



**Example 2: Fault diagnosis flow chart (RB25DE VEHICLES ONLY)**

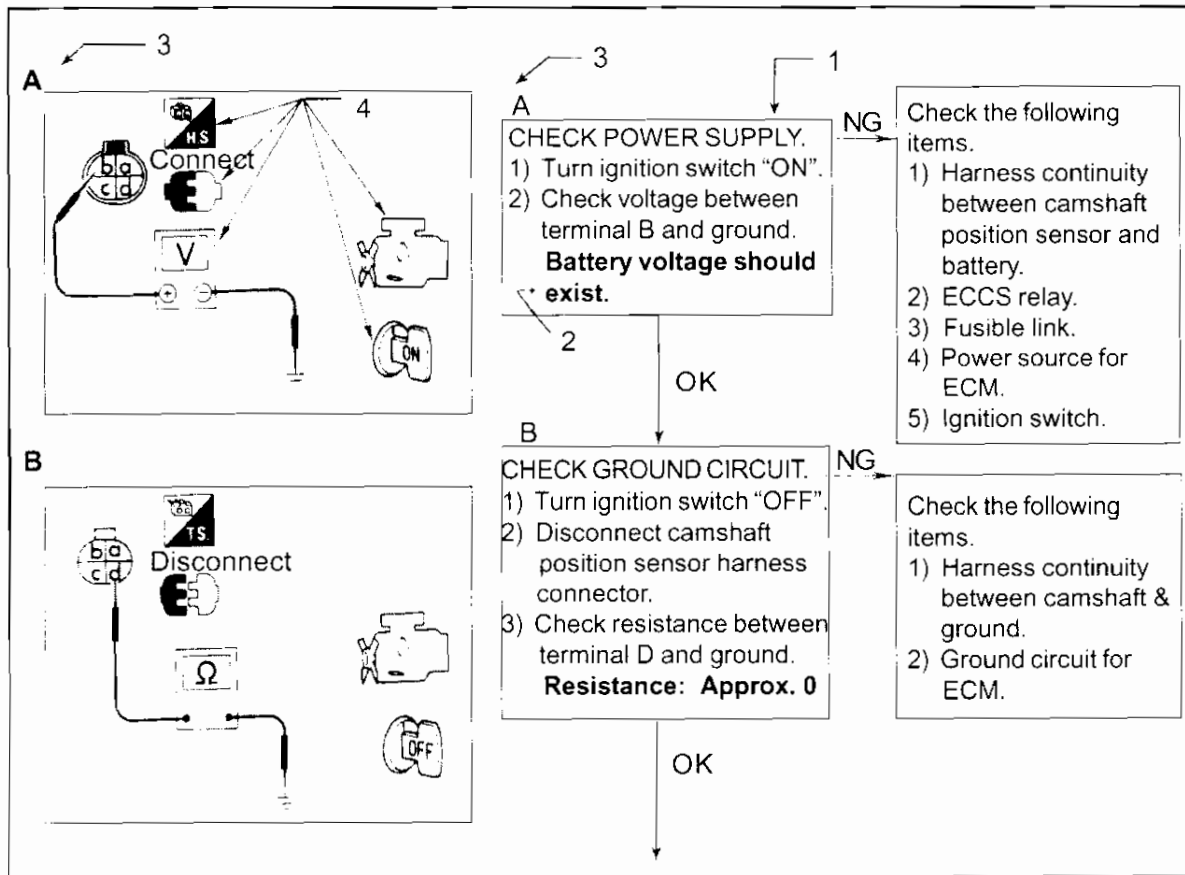

**HOW TO FOLLOW THIS FLOW CHART**

**1. Work and diagnostic procedure**

Start to diagnose a problem using procedures indicated in enclosed blocks, as shown in the following example.

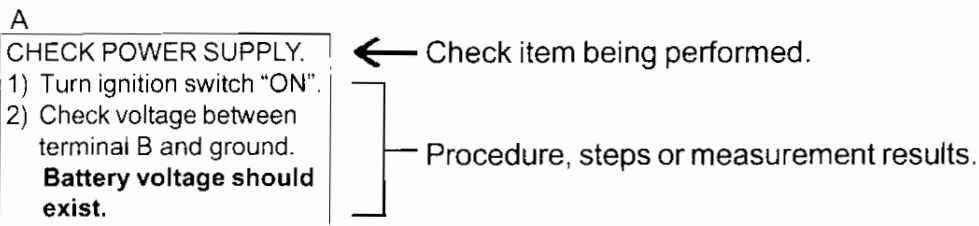

**2. Measurement results**

Required results are indicated in bold type in the corresponding block, as shown below.

These have the following meanings:

Battery voltage; 11 - 14V or approximately 12V





















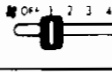

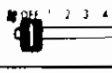









Voltage; Approximately 0V - Less than 1V

**3. Cross reference of work symbols in the text and illustrations**

Illustrations are provided as visual aids for work procedures.

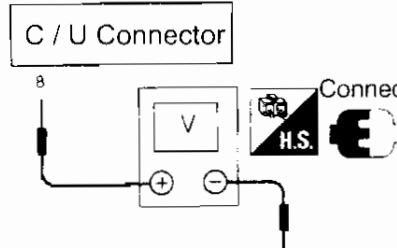
**4. Symbols used in illustrations**

Symbols included in illustrations refer to measurements or procedures. Before diagnosing a problem, familiarize yourself with each symbol.

Symbol	Symbol explanation	Symbol	Symbol explanation
	Check after disconnecting the connector to be measured.		Current should be measured with an ammeter.
	Check after connecting the connector to be measured.		Procedure with CONSULT.
	Insert key into ignition switch.		Procedure without CONSULT.
	Remove key from ignition switch.		A / C switch is "ON".
	Turn ignition switch to "OFF" position.		A / C switch is "OFF".
	Turn ignition switch to "ON" position.		Fan switch is "ON".
	Turn ignition switch to "START" position.		Fan switch is "OFF".
	Turn ignition switch from "OFF" to "ACC" position.		Apply fused battery positive voltage directly to components.
	Turn ignition switch from "ACC" to "OFF" position.		Drive vehicle.
	Turn ignition switch from "OFF" to "ON" position.		Disconnect battery negative cable.
	Turn ignition switch from "ON" to "OFF" position.		Depress brake pedal.
	Do not start engine, or check with engine stopped.		Release brake pedal.
	Start engine, or check with engine running.		Depress accelerator pedal.
	Apply parking brake.		Release accelerator pedal.
	Release parking brake.	<p>Pin terminal check for ECM and A/T control unit connectors.</p> 	
	Check after engine is warmed up sufficiently.		
	Voltage should be measured with a voltmeter.		
	Circuit resistance should be measured with an ohmmeter.		
	Circuit resistance should be measured with an ohmmeter.		

**CONNECTOR SYMBOL**

A direction mark is shown to clarify the side of connector (terminal side or harness side).

- Connector symbols shown from the terminal side are enclosed by a single line.

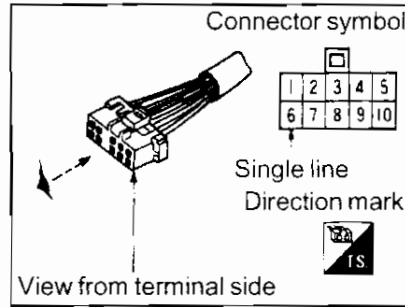

- Connector symbols shown from the harness side are enclosed by a double line.

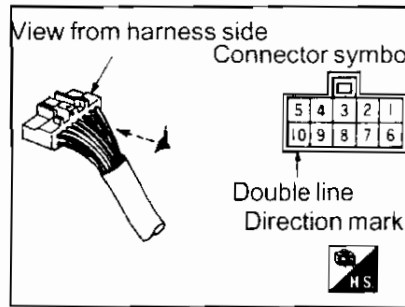

**Male & Female terminals**

Connector guides for male terminals are shown in black and female terminals in white in wiring diagrams.

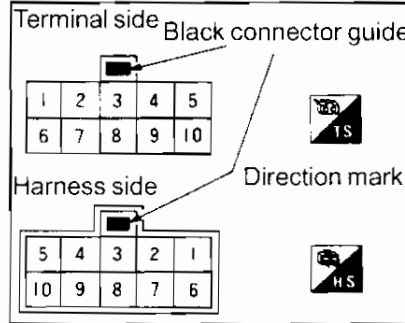

**Control unit element substances**

Element such as control unit will be shown as displayed.

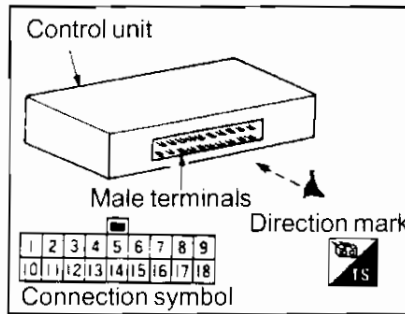

## GENERAL PRECAUTIONS

Follow the below precautions to ensure safe and proper servicing for your vehicle.

### SRS (Supplemental Restrain System) air bag

- Information necessary to service the system safely and correctly is included in the BF section of this service manual. Make sure you read the section on "SRS air bag" before maintenance operation.
- Improper maintenance, including incorrect removal and installation of the SRS air bag, can lead to personal injuries caused by unintentional activation of the system.
- Do not use electrical test equipment on any circuit related to the SRS air bag.
- All SRS electrical wiring harnesses and connectors are covered with yellow outer insulation.



### General Precautions

- Do not operate the engine for an extended period of time without proper exhaust ventilation.
- Keep the work area well ventilated and free of any flammable materials.
- Care must be taken when handling any flammable or poisonous materials.

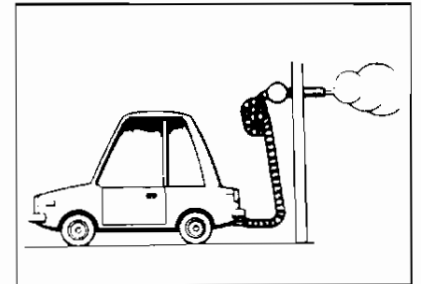

- Before servicing the vehicle, cover fenders, upholstery and carpeting with appropriate covers.

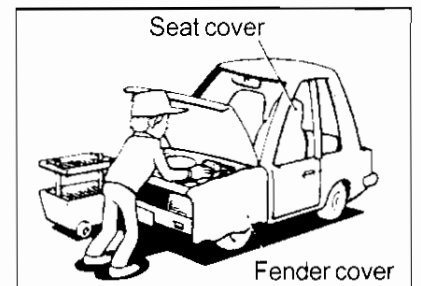

- Before jacking up the vehicle, apply wheel stoppers and only jack up the vehicle at jack up point.
- After jacking up the vehicle, support the vehicle weight with safety stands before working on the vehicle.
- When removing heavy objects such as the engine or transaxle / transmission, take care not to lose your balance and drop them. Also, do not allow them to strike parts, especially the brake tube and master cylinder.

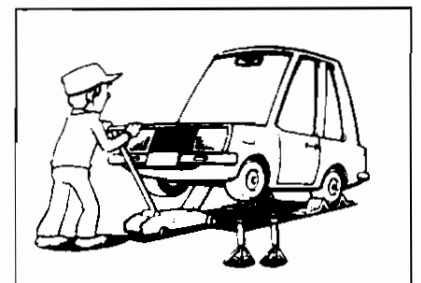

## GENERAL INFORMATION

- Before start repairs that do not require battery power, always turn off the engine and disconnect the ground cable from the battery to prevent accidental short circuit.
- Loosen the screw nut completely when removing the ground cable from the battery.

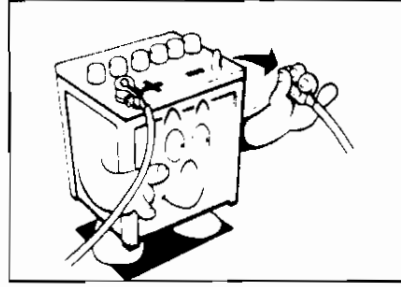

- To prevent serious burns, avoid contact with hot metal part such as the radiator, exhaust manifold, tail pipe and muffler. Carry out the operation when the parts has cooled down.
- Do not remove the radiator cap when the coolant is hot.

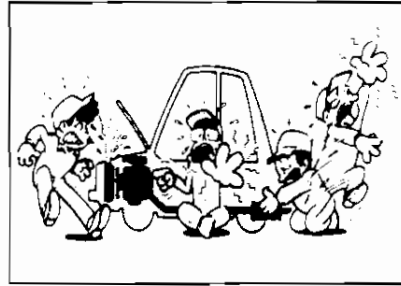

- An inspection may be difficult with a normal test probe when a connector pin is extremely small. When this is the case, wind a small pin or wire around the test probe, or sharpen the end of the probe to perform the inspection.
- Use measurement equipment such as the CONSULT electronic system diagnosis tester and an oscilloscope to perform diagnosis operation.

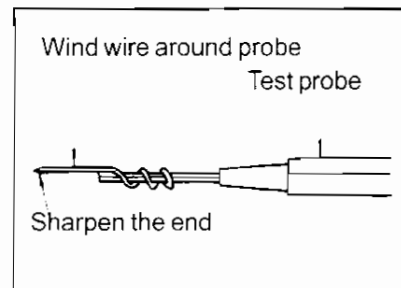

- Check the vehicle damage carefully, make a careful diagnosis of the damage and perform the correct operation.
- Check the correct part assembly condition before removal or disassembly. Make alignment marks when necessary in locations which will not interfere with the part operation.
- When replacing parts always use correct specified parts or tools.
- Replace oil seals, gaskets, packings, O-rings, locking washers, cotter pins, self locking nuts, etc. with new ones. These parts are indicated "Can not be reused" and must be replaced with new parts.
- Always replace taper-roller bearing and the needle bearing for inner and outer race as a set.
- Take care not to mix up the removed parts.
- When replacing parts always use genuine Nissan replacement parts.
- Use correct lubricants specified.
- Dispose waste oil and cleaning oil in a way that is set by the law.



**Precautions for ECCS engine**

- Before connecting or disconnecting ECCS control module harness connector, be sure to turn the ignition switch to the "OFF" position and disconnect the negative battery terminal.
- Release fuel pressure to eliminate danger before disconnecting pressurized fuel line from fuel pump to injectors.
- Do not apply any shock to the electric parts such as ECCS control unit or Airflow metre.
- Use measurement equipment to perform diagnosis operation.

**Precautions for Catalyst converter**

If a large amount of unburned fuel flows into the converter, the temperature within the converter will become excessively high. To prevent this, follow the procedure below:

- Only carry out the ignition spark or measuring engine compression checks when necessary and carry out the tests quickly.
- Do not run the engine when the fuel tank level is low, otherwise the engine may misfire causing damage to the converter.
- Only use gasoline specified.
- Do not place burnable objects below the vehicle. Keep flammable material off the exhaust pipe and the catalyst converter.

**Precautions for fuel**

Only use unleaded gasoline for gasoline engine vehicle. Using a fuel other than that specified could damage the vehicle.

## VEHICLE & UNIT IDENTIFICATION PLATE LOCATION

### Vehicle identification number (Supplement models only)

E-FR32 .....	FR32-000001 ~
E-HR32 .....	HR32-000001~
E-HCR32 .....	HCR32-000001~
E-ER32 .....	ER32-000101~
E-ECR32 .....	ECR32-000101~
E-HNR32 .....	HNR32-000001~
E-BNR32 .....	BNR32-000001~

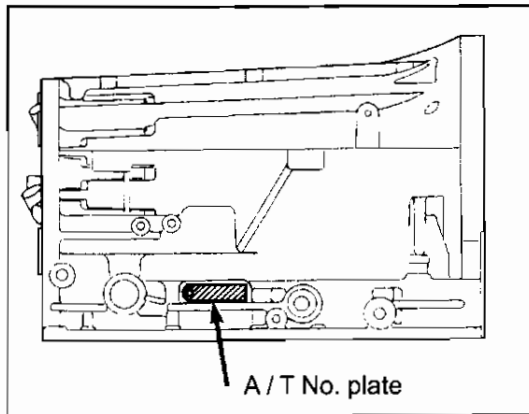
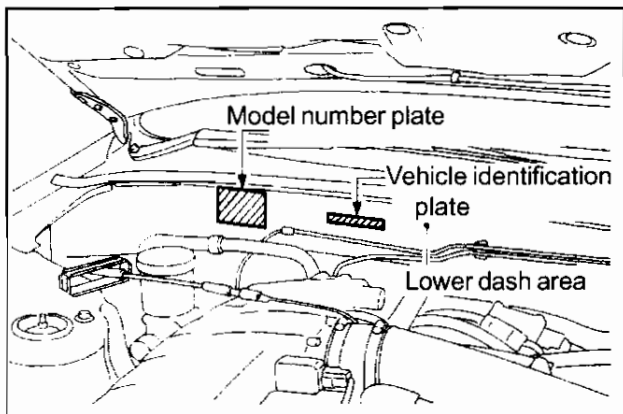

### Model number plate

1. Type
2. Vehicle identification number
3. Model
4. Body colour code
5. Trim colour code
6. Engine model
7. Engine displacement
8. Transmission model
9. Axle model

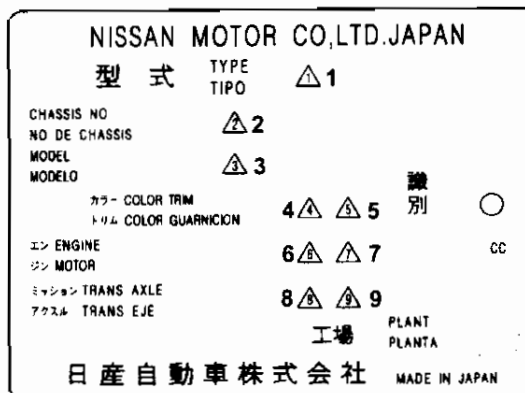

### Engine serial number

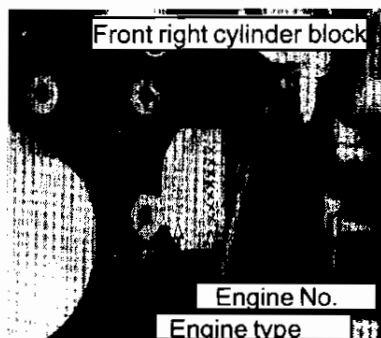

RB26DETT engine

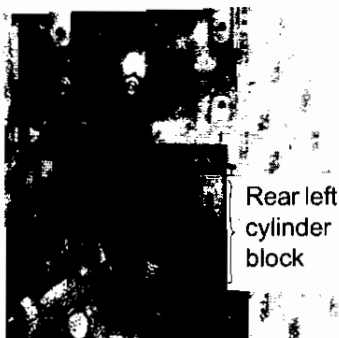

CA18i engine



RB20E / RB25DE engine

**CONSULT**

Consult is a hand-held compact type tester. It transmits signals to the vehicle loading control units when the diagnosis connector is connected and can perform all types of diagnosis and tests.

Note:

Refer to the CONSULT operation manual for further details.

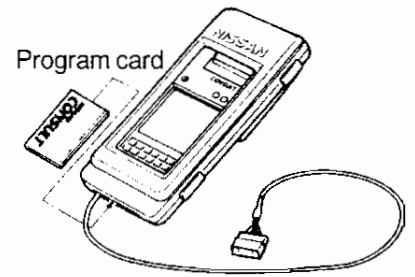

**FUNCTION**

Operation support	Transmits commands to the electrical control unit for setting the status suitable for required operation.
Function test	Diagnose the ECCS standard checks.
Self-diagnosis	Receives the self-diagnosis results from the electrical control unit and displays malfunctioning system names and the number of times a malfunction occurs.
Data monitor	Receives input and output signals from the control unit, displays and records data used to easily determine cause of malfunction.
Active test	Sends commands to the control unit and performs the operation inspection and verification of the output system according to output signal changes.
ECU part unit	Displays the part number of the electrical control unit.

**APPLICATION**

	Engine (ECCS)	A / T	HICAS	E-TS	ABS	SRS Air bag
Operation support	○					
Function test	○					
Self diagnosis	○	○	○	○	○	○
Data monitor	○	○	○			
Active test	○		○			
ECU part number	○	○	○			

## TIGHTENING TORQUE OF STANDARD BOLTS

Grade	Bolt size	Bolt diameter (mm)	Pitch (mm)	Tightening torque (without lubricant)			
				Hexagon head bolt		Hexagon flange bolt	
				N-m	kg-m	N-m	kg-m
4T	M6	6.0	1.0	5.1	0.52	6.1	0.62
	M8	8.0	1.25	13	1.3	15	1.5
			1.0	13	1.3	16	1.6
	M10	10.0	1.5	25	2.5	29	3.0
			1.25	25	2.6	30	3.1
	M12	12.0	1.75	42	4.3	51	5.2
1.25			46	4.7	56	5.7	
M14	14.0	1.5	74	7.5	88	9.0	
7T	M6	6.0	1.0	8.4	0.86	10	1.0
	M8	8.0	1.25	21	2.1	25	2.5
			1.0	22	2.2	26	2.7
	M10	10.0	1.5	41	4.2	48	4.9
			1.25	43	4.4	51	5.2
	M12	12.0	1.75	71	7.2	84	8.6
1.25			77	7.9	92	9.4	
M14	14.0	1.5	127	13.0	147	15.0	
9T	M6	6.0	1.0	12	1.2	15	1.5
	M8	8.0	1.25	29	3.0	35	3.6
			1.0	31	3.2	37	3.8
	M10	10.0	1.5	59	6.0	70	7.1
			1.25	62	6.3	74	7.5
	M12	12.0	1.75	98	10.0	118	12.0
1.25			108	11.0	137	14.0	
M14	14.0	1.5	177	18.0	206	21.0	

Special parts are excluded.

This standard is applicable to bolts having the following marks embossed on the bolt head.

Grade	Mark
4T	4
7T	7
9T	9

## TOWING

### Front

After removing the front spoiler, attach a cable to the hook in the front part of the front side member.

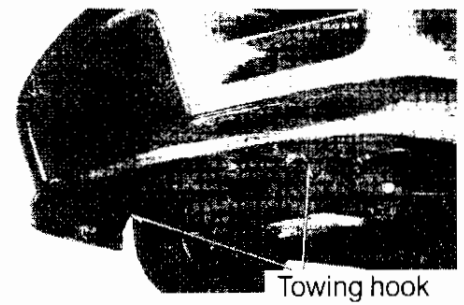

### Rear

Attach a cable to the hook mounted in the rear part of the rear side member.

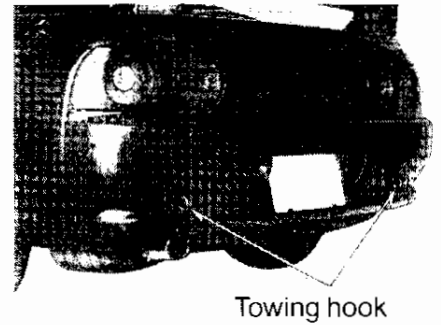

## 2-POLE LIFT

The two-pole lifting points are the same as for the right rack.

### Caution:

Make sure the vehicle is empty when lifting up the vehicle.

Make sure the side sill and lift arm (rear part) do not contact each other when lifting up the vehicle.

## Board-on Lift

The board-on lift attachment (LM4086-0200) set at the front end of the vehicle should be set on the front of the sill under the front door opening.

Position the adapter on both sides of the board-on lift.

### Caution:

Make sure the vehicle is empty when lifting.

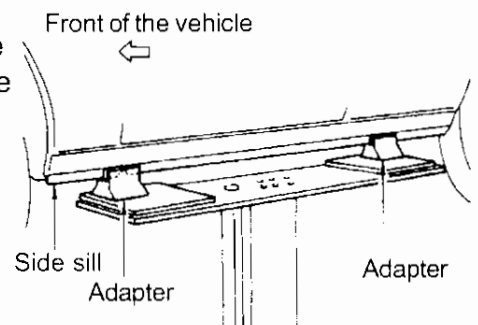



## HYDRAULIC JACK LIFTING & JACK STAND SUPPORT

### Caution:

- Make sure the vehicle is empty when lifting.
- When the front side is jacked up, raise the front sill edge slightly using the jack and then jack the vehicle up.
- Use the attachment (LM4519-0000) when a vehicle is supported by jack stand.
- Take care not to allow the jack stand to crush brake tubes or fuel lines when using jack stand.

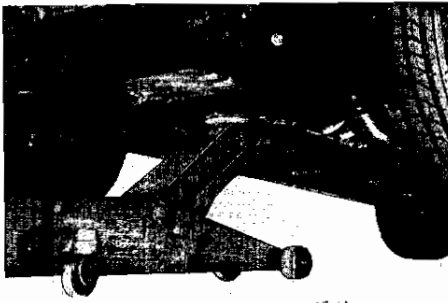

Place jack at the centre of the suspension member



Place jack at the centre of the differential gear

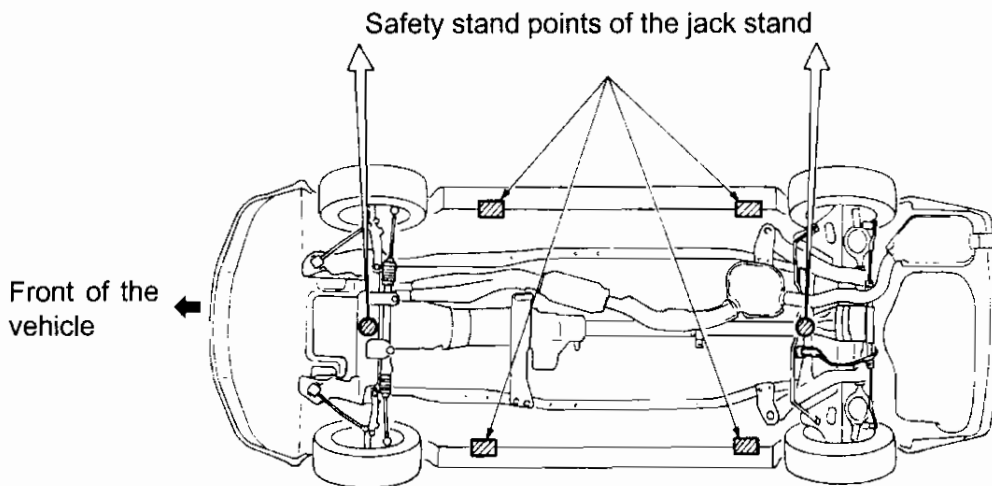

## 4WD INSPECTION & REPAIR PRECAUTIONS

Follow the precautions below to measure the speedometer reading and to check braking performance in the 4WD mode.

### SPEEDOMETER MEASUREMENT

Two methods to measure the speedometer are described below.

#### 1. Measurement with front wheels jacked up

- Place the rear wheels on the roller.
- Support the car on jack stand with front wheels jacked up using the attachment.
- Place the transmission in 2nd gear for the manual transmission vehicle and release the clutch slowly. For automatic vehicles place the shift lever in 2nd and increase the speed gradually.
- When the test is completed, do not apply the brakes suddenly.

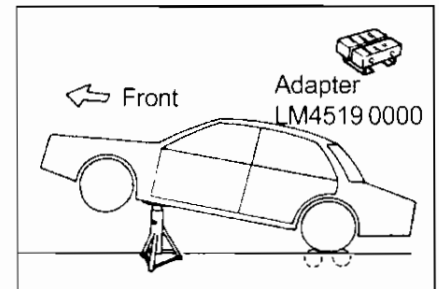

#### Caution:

Place the jack securely, and perform the measurement after making sure the vehicle is stable.

Use the free rollers whenever possible.

#### 2. Measurement using simple free roller

- Set the simple free roller the length of the wheel base (2615mm) forward of the centre of the measurement roller as shown in the diagram.
- Place the front wheel on the simple free rollers and the rear wheels on the measurement rollers.
- Place the gear in 2nd for the manual transmission vehicles and gradually release the gear. For automatic vehicles place the shift lever in 2nd and increase the speed gradually.
- When the test is completed, do not apply the brakes suddenly.

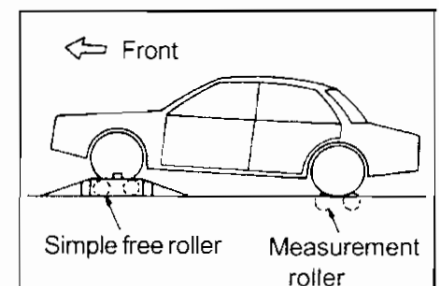
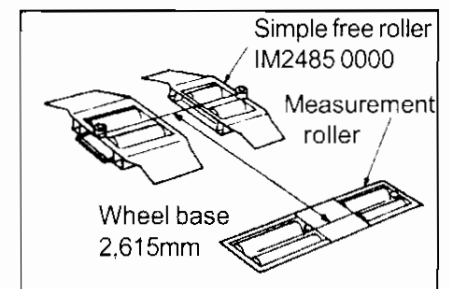

### BRAKING PERFORM CHECK

#### Pre-Inspection preparations

The performance check must be carried out in 2WD mode. To switch to 2WD mode, either use the front propeller shaft removal method or remove the fusible ink from the engine bay.

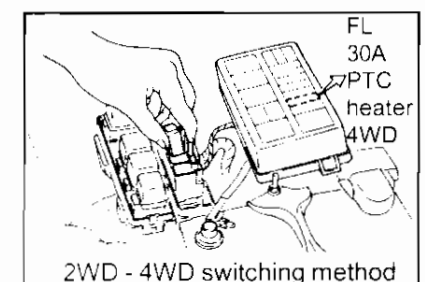

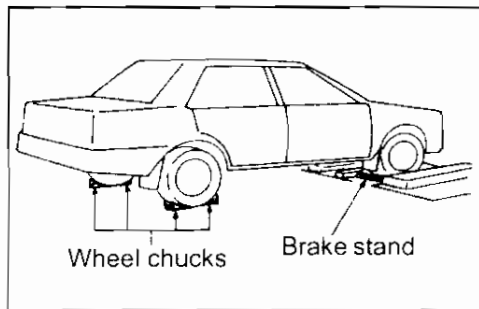
**INSPECTION POINTS****(When fusible link in the engine bay is removed)**

Removed the 4WD fusible link 30A from the engine bay relay box with engine turned off.

Turn on the ignition. Repeat the engine deceleration operation from full throttle to no throttle until the 4WD warning light on instrument panel lights.

Note: The vehicle may not enter 2WD mode when this operation is not performed.

Turn the ignition switch in OFF position once the 4WD warning light has turned on.

Turn on the ignition switch and make sure the 4WD warning light is on.

Position the vehicle on rollers, set shift and range into neutral position.

Press the pedal. Release pedal when OK zone is reached or OK lamp lights.

Note:

If the drag exceeds 10% of the axle weight when the drag test is performed, the wheel rotation must be checked with the vehicle jacked up. If there is no abnormality, it can be assumed that the drag is caused by the viscous torque and there is no brake abnormality.

Place the ignition to OFF position and place the fusible link back to its normal location.

Place the ignition back to ON position and make sure the 4WD warning light turns off and 4WD mode is set.

End

## 4WD VEHICLE TOWING PRECAUTIONS

### Towing precautions

Never tow a 4WD vehicle for a distance over 30 km and do not exceed speed limit of 30 km / h.  
Never tow a 4WD vehicle with front or rear wheels raised and opposite rear or front wheels on the ground as this may cause serious damage to the transaxle.

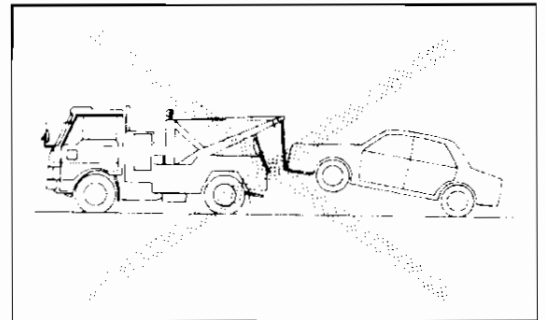
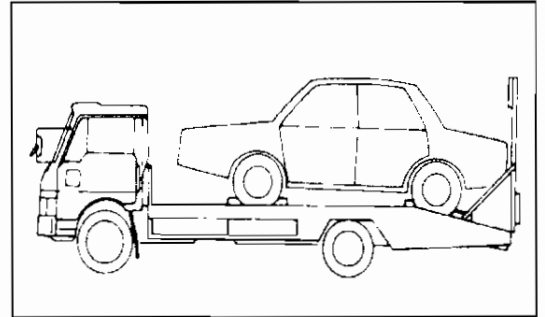

# SECTION **EN** ENGINE

## CONTENTS

### EN1 ENGINE SPECIFICATIONS

MAIN ENGINE SPECIFICATIONS .....	EN - 6
EMISSION CONTROL EQUIPMENT SPECIFICATIONS .....	EN - 7
SPECIAL SERVICE TOOLS .....	EN - 8
SYSTEM DIAGRAM .....	EN - 13
VACUUM DIAGRAM .....	EN - 19

### EN2 RB26DETT / RB20E / DE / DET / RB25DE / CA18i ENGINE

1. IDLE SPEED / IGNITION TIMING / IDLE MIXTURE RATIO INSPECTION .....	EN - 23
2. COMPRESSION PRESSURE INSPECTION .....	EN - 42
3. BELT TENSION INSPECTION & ADJUSTMENT .....	EN - 43
4. VALVE CLEARANCE INSPECTION & ADJUSTMENT .....	EN - 45
5. LUBRICATION SYSTEM .....	EN - 47
6. EXHAUST SYSTEM INSPECTION	
RB26DETT / RB20DE / DET / RB20E / RB25DE .....	EN - 49
CA18i .....	EN - 51
7. FUEL PUMP SYSTEM INSPECTION .....	EN - 52
8. EVAPORATIVE GAS CONTROL INSPECTION .....	EN - 54
9. BLOWBY GAS REDUCTION DEVICE INSPECTION .....	EN - 55
10. ON-VEHICLE PARTS REMOVAL & INSTALLATION	
RB26DETT .....	EN - 56
RB20E .....	EN - 105
RB20DE, DET .....	EN - 115
CA18i .....	EN - 137
RB25DE .....	EN - 151
11. ENGINE REMOVAL & INSTALLATION	
RB26DETT .....	EN - 180
RB20E, DE, DETT, CA18i .....	EN - 182
RB25DE .....	EN - 184
12. ENGINE OVERHAUL	
RB26DETT .....	EN - 186
RB25DE .....	EN - 202
RB20E / DE / DET .....	EN - 217



**EN3 ECCS (ELECTRONICALLY CONCENTRATED ENGINE CONTROL SYSTEM)**

1.	TROUBLE DIAGNOSIS .....	EN - 231
2.	DIAGNOSTIC SYSTEM .....	EN - 259
3.	BASIC INSPECTION	
	RB26DETT / RB20E / DE / DET / CA18i .....	EN - 272
	RB25DE .....	EN - 276
4.	SYSTEM FIGURE & CIRCUIT DIAGRAM	
	RB26DETT .....	EN - 280
	RB20E .....	EN - 284
	RB20DE .....	EN - 288
	RB20DET .....	EN - 292
	CA18i .....	EN - 294
	RB25DE .....	EN - 298
5.	ACTUATOR SYSTEM INSPECTION (RB26DETT / CA18i / RB20E / DE / DET)	
5 - 1	FUEL PUMP SYSTEM INSPECTION .....	EN - 302
5 - 2	INJECTOR SYSTEM INSPECTION .....	EN - 314
5 - 3	IGNITION SYSTEM INSPECTION .....	EN - 328
5 - 4	IDLE SPEED CONTROL SYSTEM INSPECTION .....	EN - 339
5 - 5	WASTEGATE VALVE CONTROL SYSTEM INSPECTION (RB26DETT ONLY) .....	EN - 350
5 - 6	PTC HEATER CONTROL SYSTEM INSPECTION (CA18i ONLY) .....	EN - 352
5 - 7	LOCK UP RELEASE CONTROL SYSTEM INSPECTION (CA18i A/T ONLY) .....	EN - 353
6.	SENSOR SYSTEM INSPECTION (RB26DETT / CA18i / RB20E / DE / DET)	
6 - 1	CRANK ANGLE SENSOR SYSTEM INSPECTION (CODE No. 11 IN SELF-DIAGNOSIS) .....	EN - 354
6 - 2	AIR FLOW METER SENSOR SYSTEM INSPECTION (CODE No. 12 IN SELF-DIAGNOSIS) (RB26DETT / RB20E / DE / DET) .....	EN - 361
6 - 3	THROTTLE VALVE SWITCH SYSTEM INSPECTION (RB26DETT / RB20E / DE / DET) .....	EN - 368
6 - 4	THROTTLE SENSOR SYSTEM INSPECTION (CODE No. 43 IN SELF-DIAGNOSIS) (RB26DETT / RB20E / DE / DET) .....	EN - 371
	(CA18i) .....	EN - 375
6 - 5	INTAKE AIR TEMPERATURE SENSOR SYSTEM (CODE No. 41 IN SELF-DIAGNOSIS) (CA18i / RB26DETT ONLY) .....	EN - 378
6 - 6	ENGINE TEMPERATURE SENSOR SYSTEM INSPECTION (CODE No. 13 IN SELF-DIAGNOSIS) .....	EN - 380
6 - 7	EXHAUST GAS SENSOR SYSTEM INSPECTION (CODE No. 15 IN SELF-DIAGNOSIS) .....	EN - 386
6 - 8	DETONATION SENSOR SYSTEM INSPECTION (CODE No. 34 IN SELF-DIAGNOSIS) (RB26DETT / RB20E ONLY) .....	EN - 395
6 - 9	VEHICLE SPEED SENSOR SYSTEM INSPECTION .....	EN - 397
6 - 10	IGNITION SWITCH (START SWITCH) SIGNAL INSPECTION .....	EN - 398
6 - 11	AIR CONDITIONER SIGNAL INSPECTION .....	EN - 399
6 - 12	NEUTRAL SWITCH SIGNAL INSPECTION .....	EN - 399

6 - 13	POWER STEERING SWITCH SIGNAL INSPECTION .....	EN - 400
6 - 14	LIGHT SWITCH SIGNAL INSPECTION (CA18i) .....	EN - 400
6 - 15	HEATER FAN SIGNAL INSPECTION (CA18i) .....	EN - 400
7.	RB25DE DIAGNOSIS	
DIAG 1	POWER SUPPLY & GROUND CIRCUIT .....	EN - 401
DIAG 2	CRANK ANGLE SENSOR (CODE No. 11 IN SELF-DIAGNOSIS) .....	EN - 404
DIAG 3	AIR FLOW METER (CODE No. 12 IN SELF-DIAGNOSIS) .....	EN - 407
DIAG 4	ENGINE TEMPERATURE SENSOR (CODE No. 13 IN SELF-DIAGNOSIS) .....	EN - 410
DIAG 5	IGNITION SIGNAL (CODE No. 21 IN SELF-DIAGNOSIS) .....	EN - 412
DIAG 6	EXHAUST GAS SENSOR (CODE No. 15 IN SELF-DIAGNOSIS) .....	EN - 415
DIAG 7	DETONATION SENSOR (CODE No. 34 IN SELF-DIAGNOSIS) .....	EN - 417
DIAG 8	THROTTLE SENSOR (CODE No. 43 IN SELF-DIAGNOSIS) .....	EN - 419
DIAG 9	A/T CONTROL (CODE No. 54 IN SELF-DIAGNOSIS) .....	EN - 421
DIAG 10	CRANK ANGLE SENSOR (NOT IN SELF-DIAGNOSIS) .....	EN - 442
DIAG 11	IGNITION SIGNAL 1 (NOT IN SELF-DIAGNOSIS) .....	EN - 424
	IGNITION SIGNAL 2 .....	EN - 427
DIAG 12	INJECTOR SYSTEM INSPECTION .....	EN - 428
DIAG 13	VEHICLE SPEED SENSOR .....	EN - 431
DIAG 14	AIR CONDITIONER RELAY SIGNAL .....	EN - 433
DIAG 15	EXHAUST GAS SENSOR HEATER .....	EN - 434
DIAG 16	THROTTLE VALVE SWITCH .....	EN - 436
DIAG 17	START SIGNAL .....	EN - 439
DIAG 18	FUEL PUMP CONTROL .....	EN - 440
DIAG 19	AAC VALVE .....	EN - 443
DIAG 20	AIR REGULATOR .....	EN - 445
DIAG 21	POWER STEERING HYDRAULIC PRESSURE SW .....	EN - 447
DIAG 22	IDLE REV IS TOO HIGH (AFTER WARM UP) .....	EN - 449
DIAG 23	HUNTING .....	EN - 450
DIAG 24	IDLE INSTABILITY .....	EN - 451
DIAG 25	WHEN COLD, DIFFICULT TO START OR CAN NOT START THE ENGINE .....	EN - 454
DIAG 26	WHEN WARM, DIFFICULT TO START OR CAN NOT START THE ENGINE .....	EN - 456
DIAG 27	IN NORMAL CONDITION, DIFFICULT TO START OR CAN NOT START THE ENGINE .....	EN - 458
DIAG 28	HESITATION AFTER WARM UP .....	EN - 460
DIAG 29	HESITATION WHEN COLD .....	EN - 461
DIAG 30	HESITATION IN NORMAL CONDITION .....	EN - 462

DIAG 31	ENGINE STALL WHILE REVING .....	EN - 463
DIAG 32	ENGINE STALL AFTER WARM UP .....	EN - 465
DIAG 33	ENGINE STALL WHEN COLD .....	EN - 467
DIAG 34	ENGINE STALL WHEN ACCELERATING INSTANTLY .....	EN - 469
DIAG 35	ENGINE STALL WHEN DECELERATING .....	EN - 471
DIAG 36	ENGINE STALL WHEN ACCELERATING OR DRIVING AT CONSTANT SPEED .....	EN - 474
DIAG 37	ENGINE STALL WHEN LOADING BATTERY .....	EN - 476
DIAG 38	POWER SHORTAGE AND TUMBLE (INSTANT POWER OUTPUT SHORTAGE DURING ACCELERATION) .....	EN - 478
DIAG 39	DETONATION .....	EN - 479
DIAG 40	SURGE .....	EN - 480
DIAG 41	BACK FIRE (SPITTING) .....	EN - 481
DIAG 42	AFTER BURNING .....	EN - 481
8.	RB25DE COMPONENTS INSPECTION .....	EN - 482
9.	ECCS CONTROL UNIT INPUT / OUTPUT SIGNALS	
	RB20DETT .....	EN - 490
	RB20E / DE / DET .....	EN - 499
	CA18i .....	EN - 513
	RB25DE .....	EN - 520
10.	DECELERATION EXHAUST GAS EMISSION CONTROL EQUIPMENT INSPECTION .....	EN - 527
11.	AIR CONDITIONER CUT SYSTEM INSPECTION .....	EN - 528

**EN4 ENGINE ELECTRICAL EQUIPMENT**

	SPECIFICATION .....	EN - 529
1.	BATTERY INSPECTION .....	EN - 530
2.	ALTERNATOR .....	EN - 530
3.	STARTER MOTOR REMOVAL & INSTALLATION .....	EN - 531
4.	SPARK PLUG INSPECTION .....	EN - 531
5.	PLATINUM PLUG INSPECTION .....	EN - 531
6.	IGNITION COIL INSPECTION .....	EN - 532

**EN5 COOLING SYSTEM**

	SPECIFICATION .....	EN - 533
1.	RADIATOR INSPECTION .....	EN - 534
2.	RADIATOR CAP INSPECTION .....	EN - 534
3.	COOLING WATER FILLING PROCEDURE .....	EN - 534
4.	RADIATOR REMOVAL & INSTALLATION .....	EN - 535
5.	SUB ELECTRICAL FAN INSPECTION .....	EN - 536
6.	THERMOSTAT INSPECTION .....	EN - 536

**EN6 FUEL SYSTEM**

	SPECIFICATION .....	EN - 537
1.	FUEL TANK REMOVAL & INSTALLATION .....	EN - 538
2.	FUEL GAUGE .....	EN - 539
3.	FUEL PUMP REMOVAL & INSTALLATION .....	EN - 541

**EN7 EXHAUST SYSTEM**

- SPECIFICATION ..... EN - 542
1. EXHAUST PIPE, CATALYTIC CONVERTER  
& HEAT PANEL TIGHTENING TORQUES ..... EN - 543
  2. EXHAUST GAS TEMPERATURE WARNING EQUIPMENT INSPECTION . EN - 545

**EN8 ENGINE CONTROL**

1. ACCELERATOR PEDAL INSPECTION & ADJUSTMENT ..... EN - 546
2. ASCD ..... EN - 547

**EN9 ENGINE MOUNTING**

1. FRONT ENGINE MOUNTING ..... EN - 560
2. REAR ENGINE MOUNTING ..... EN - 560

# EN1 ENGINE SPECIFICATIONS

## MAIN ENGINE SPECIFICATIONS





Vehicle model		E-FR32	E-HR32, E-HCR32		E-HCR32 E-HNR32	E-ECR32	E-BNR32	
Engine type		CA18i	RB20E	RB20DE	RB20DET	RB25DE	RB26DETT	
Displacement (cc)		1809	1998	1998	1998	2498	2568	
Combustion chamber		Semisphere type	Pent-roof type					
Valve arrangement		SOHC belt drive		DOHC belt drive				
Bore x Stroke (mm)		83.0 x 83.6	78.0 x 69.7	78.0 x 69.7	78.0 x 69.7	86.0 x 71.7	86.0 x 73.7	
Compression ratio		8.8	9.5	10.2	8.5	10.0	8.5	
Compression pressure (kg / cm <sup>2</sup> ) / (rpm)		12.2 / 135	12.5 / 300	13.0 / 300	12.0 / 300	12.8 / 300	12.0 / 300	
Maximum output (net) (PS / rpm)		91 / 5200	125 / 5600	155 / 6400	215 / 6400	180 / 6000	280 / 6800	
Maximum torque (net) (kg-m / rpm)		14.5 / 3200	17.5 / 4400	18.8 / 5200	27.0 / 3200	23.0 / 5200	36.0 / 4400	
Fuel consumption ratio (g / GS.h) / (rpm)		210 / 2400	215 / 2400	205 / 3200	215 / 2400	200 / 3200	200 / 2800	
Dimensions (L x W x H) (mm)		M / T	630 x 600 x 685	845 x 590 x 655	845 x 630 x 660	845 x 660 x 685	845 x 630 x 660	870 x 665 x 675
		A / T	615 x 600 x 685	830 x 590 x 655	830 x 630 x 660	830 x 660 x 685	830 x 630 x 660	-
Valve opening & closing cycle		Intake valve opening angle (degrees)	12	14	5	5	8	7
		Intake valve closing angle (degrees)	48	50	47	55	52	53
		Exhaust valve opening (degrees)	54	58	57	60	54	63
		Exhaust valve opening (degrees)	14	10	3	0	2 (BTDC)	7 (BTDC)
Valve clearance		Intake (warm) (mm)	0.30	0 (Automatic adjustment type)				0.51
		Exhaust (warm) (mm)	0.30	0 (Automatic adjustment type)				0.44
Idle speed (rpm)		M / T	700	600	650	650	650	950
		A / T	800	650	650	650	650	650
Ignition timing (BTDC° / rpm)		M / T	13 / 700	20 / 600	15 / 650	15 / 650	15 / 650	20 / 950
		A / T	13 / 800	20 / 650	15 / 650	20 / 650	15 / 650	15 / 560
Preparation target value		Idle CO density (%)	Below 0.1					
		Idle HC density (ppm)	Below 50					
Engine oil (factory)		Standard	7.5W - 30 (SG grade)		7.5W - 30 (SG grade turbo)	7.5W - 30 (SG grade)	7.5W - 30 (SG grade turbo)	
		Cold climate version						
Oil pan capacity (H level) (L)		3.4	4.0	4.0	4.5 (4WD) & 4.0		4.5	
Oil filter capacity (L)		Approx. 0.4						
Total engine coolant capacity (L)		Approx. 7.0	Approx. 8.0	Approx. 9.0	Approx. 9.0	Approx. 9.0	Approx. 9.0	





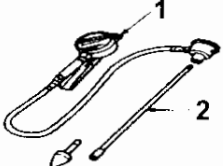

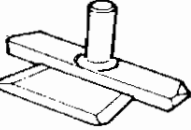
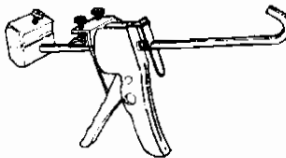
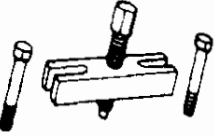
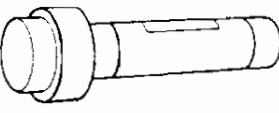
## EMISSION CONTROL EQUIPMENT SPECIFICATION

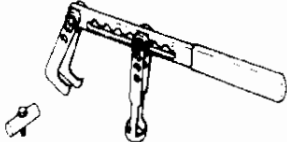
Vehicle model		E-FR32	E-HR32, E-HCR32		E-HCR32 E-HNR32	E-ECR32	E-BNR32
Engine type		CA18i	RB20E	RB20DE	RB20DET	RB25DE	RB26DETT
Engine fuel system		SPI (ECCS)	ECCS				
Air / fuel ratio control system		Air / fuel ratio feedback					
Temperature control air cleaner		Automatic	-	-	-	-	-
Supplemental start equipment		Idle-up solenoid	Bi-metal type air regulator				
Intake heat system		Hot water heating	-	-	-	-	-
Ignition system		Breakerless type (ECCS)	Breakerless type (ECCS electrical distributor)				
CO,HC (NOx) reduction equipment	EGR control system	-	-	-	-	-	-
	TV valve operation temperature	-	-	-	-	-	-
	Catalyzer type	Three-way catalyst (monolithic type)					
	Catalytic converter size (capacity in L)	(0.9)	X3 (1.7)		X4 (1.3)		X3 (1.7)
Deceleration exhaust gas reduction equipment	Fuel cutoff equipment	○	-	-	-	-	○
Exhaust gas temperature warning equipment (Setting temperature °C)		Thermocouple (940)	Thermocouple (850)				
Evaporative gas control system		Canister system					
Blowby gas reduction system		Closed system					

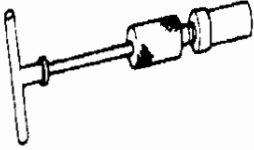
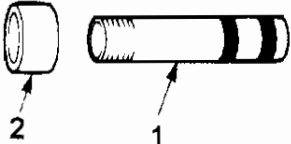
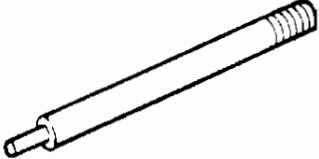
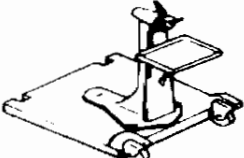
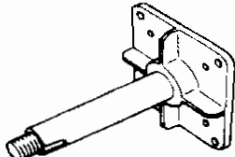
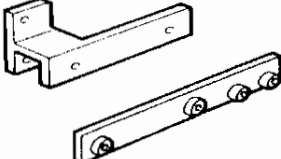
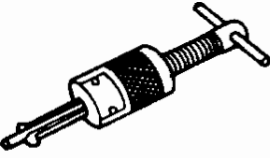
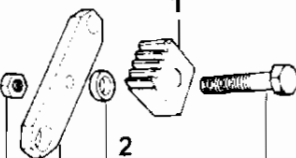
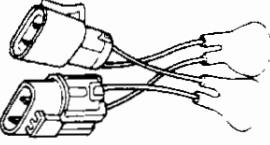
**SPECIAL SERVICE TOOLS**

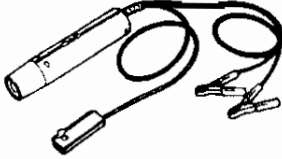
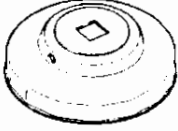
NAME		USE
<b>Spark plug wrench</b> EG1740 1600		Removal & Installation of hexagonal spark plug
<b>Allen compression gauge</b> EG15-5 0000 <b>Adapter</b> EG1505 0101		Engine compression pressure inspection
<b>Electronic system diagnosis tester CONSULT</b> EG1180 0000		Idle test & adjustment
<b>Seal cutter</b> KV101 11100		Oil pan removal
<b>Tube presser</b> WS3993		Liquid gasket lubrication
<b>Pulley puller</b> ST2718 0001		Removal & Installation of crank pulley
<b>Oil seal drift</b> ST0153 0000 KV401 00900 ST3002 2000		Oil seal insertion
<b>Pulley holder</b> KV101 09300 KV101 09900 ST3512 0000 ST3153 0000		Cam pulley bolt removal & installation
<b>Valve spring compressor</b> KV101 16200 ST1207 0000 KV101 08950 KV101 09210		Valve spring installation & removal

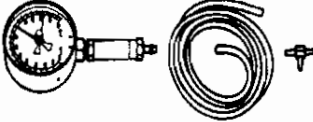
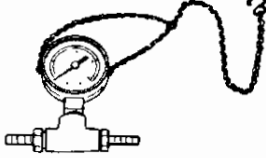
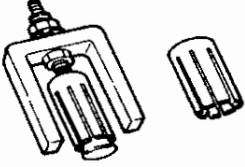
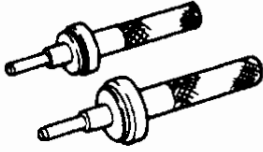
NAME		USE
<b>Valve oil seal puller</b> KV101 07901 KV101 07902		Valve seal removal
<b>Valve oil seal drift</b> KV101 07501 <b>Drift attachment</b> KV101 11400		Valve oil seal insertion
<b>Valve guide drift</b> KV101 16000		Valve guide installation & removal
<b>Engine stand ASSY</b> ST0501 5000		Engine main unit over haul
<b>Engine attachment</b> KV101 06500		Engine main unit overhaul
<b>Engine sub-attachment</b> KV101 10700		Engine main unit overhaul
<b>Pilot bearing puller</b> ST1661 0001		Pilot bush removal
<b>Ring gear topper</b> 1. KV101 104S0 2. KV101 05610		Flywheel & drive plate installation
<b>Adapter harness for mold coil (1 poles)</b> EG1116 0000		Ignition primary signal removal

NAME		USE
<b>Timing light</b> EG1443 0000 EG1443 0001		Ignition timing check
<b>Oil filter wrench</b> KV101 06250		Removal & installation of oil filter
<b>Vacuum gauge</b> EG1512 0000		Automatic temperature adjustment air cleaner inspection
<b>Vacuum hand pump</b> EG1513 0000		Automatic temperature adjustment air cleaner inspection
<b>Compound gauge</b> EG1508 0001		Turbo charger pressure-charging inspection
<b>Fuel pressure gauge</b> ST1959 0000		Measuring fuel pressure
<b>Valve seat remover</b> Intake side, exhaust side		Valve seat removal
<b>Valve seat drift</b> Intake side, exhaust side		Valve seat insertion
<b>Valve seat cutter set</b>		Valve seat form correction

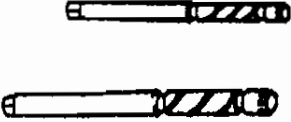
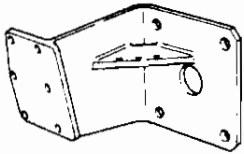
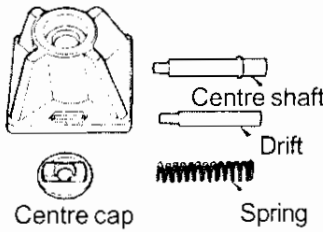
NAME		USE
<p>Valve guide reamer for guide insertion hole correction Exhaust side</p> <p><b>Guide inner diameter correction</b> Intake side KV101 11600 (6.0 mm) Exhaust side KV101 07700 (7.0 mm)</p>		<p>Valve guide insertion hole and guide internal diameter correction</p>
<p><b>Engine sub attachment</b> KV101 14500</p>		<p>Engine main unit overhaul</p>
<p><b>Piston pin press stand ASSY</b> Press stand <b>ST1303 0020</b> Spring <b>ST1303 0030</b> Drift <b>KV101 09730</b> Centre shaft <b>KV101 10810</b> Centre cap <b>KV101 10820</b></p>	<p>Press stand</p>  <p>Centre shaft Drift Centre cap Spring</p>	<p>Remove &amp; install piston pin</p>

**Multipurpose tools**

Valve guide reamer - Installation of the valve guide.

Valve seal cutter - Installation of the valve seal.

Piston ring compressor - Installation of the piston ASSY.

Piston ring expander - Installation & removal of the piston ring.

**Measurement tools**

V block

Dial gauge

Micrometer

Inside micrometer

Thickness gauge

Valve spring tester

Depth gauge

Protractor

Magnet stand

Plastigauge

Con'rod aligner

Bore gauge

Straight edge ruler

# SYSTEM DIAGRAM RB20E - EGI (ECCS) ENGINE

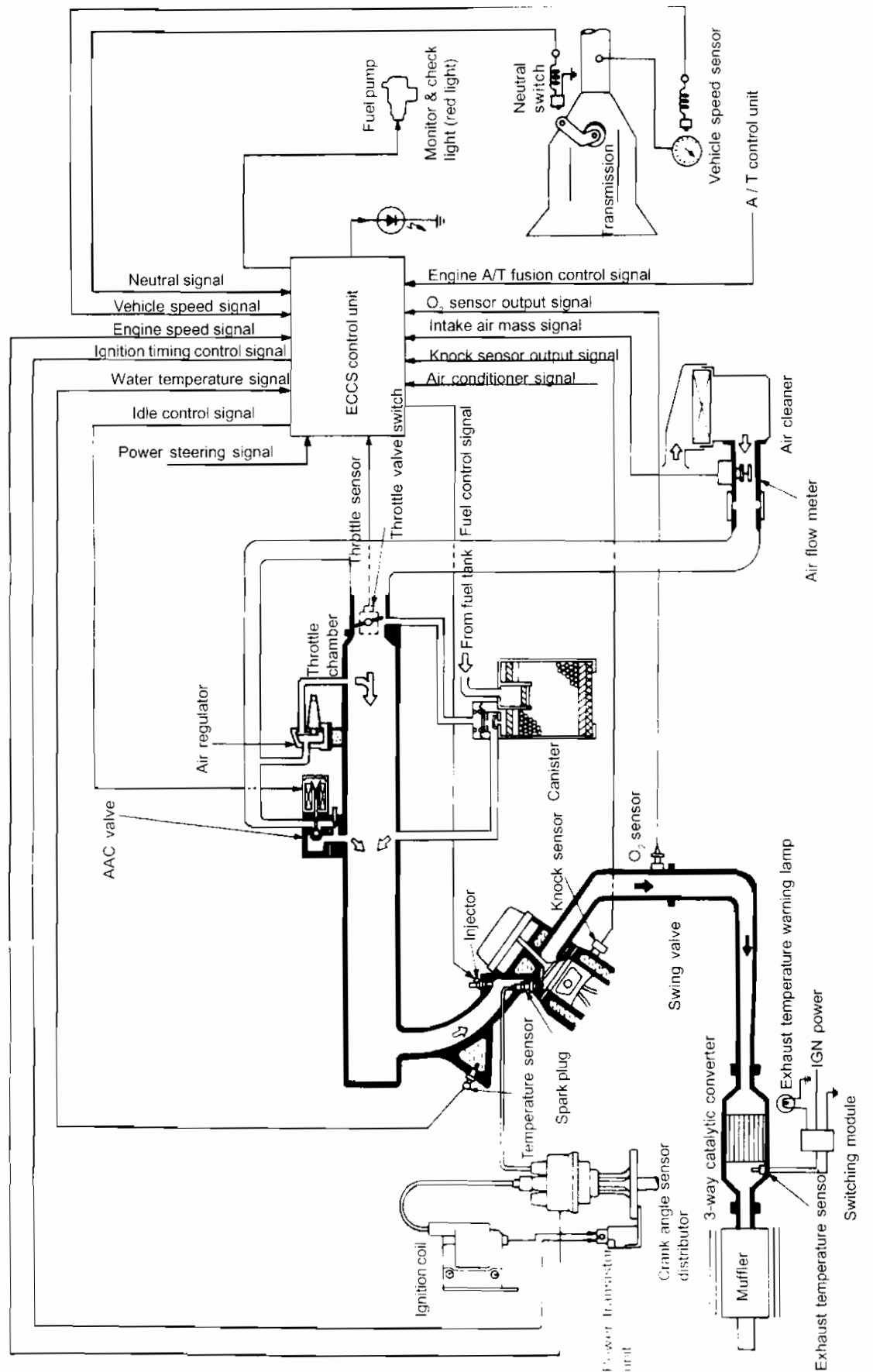

RB20 DOHC - EGI (ECCS) ENGINE

SYSTEM DIAGRAM  
RB20DE DOHC - EGI (ECCS) ENGINE

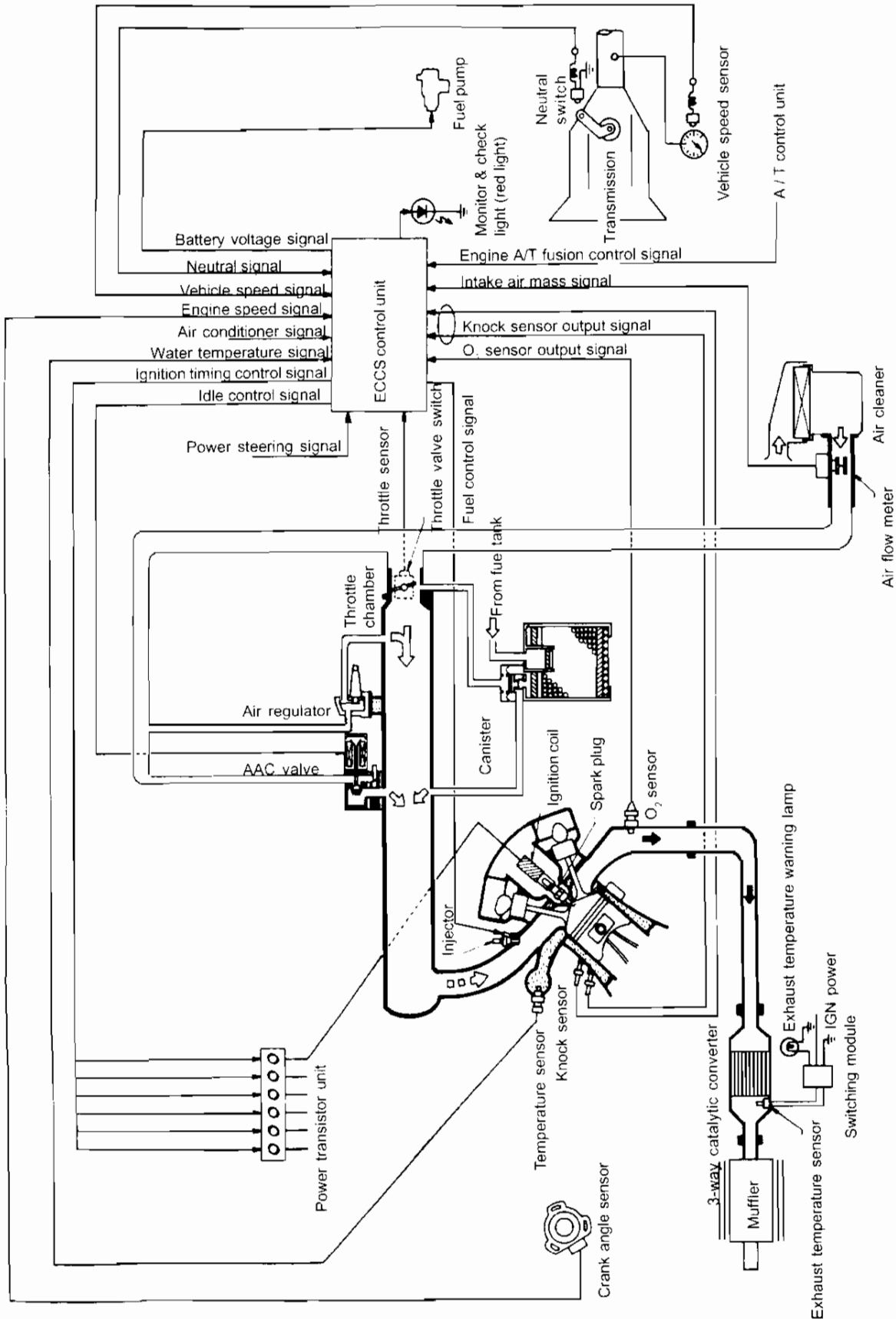



RB20 DOHC - EGI (ECCS) TURBOCHARGER ENGINE

SYSTEM DIAGRAM

RB20DET DOHC - EGI (ECCS) TURBOCHARGER ENGINE

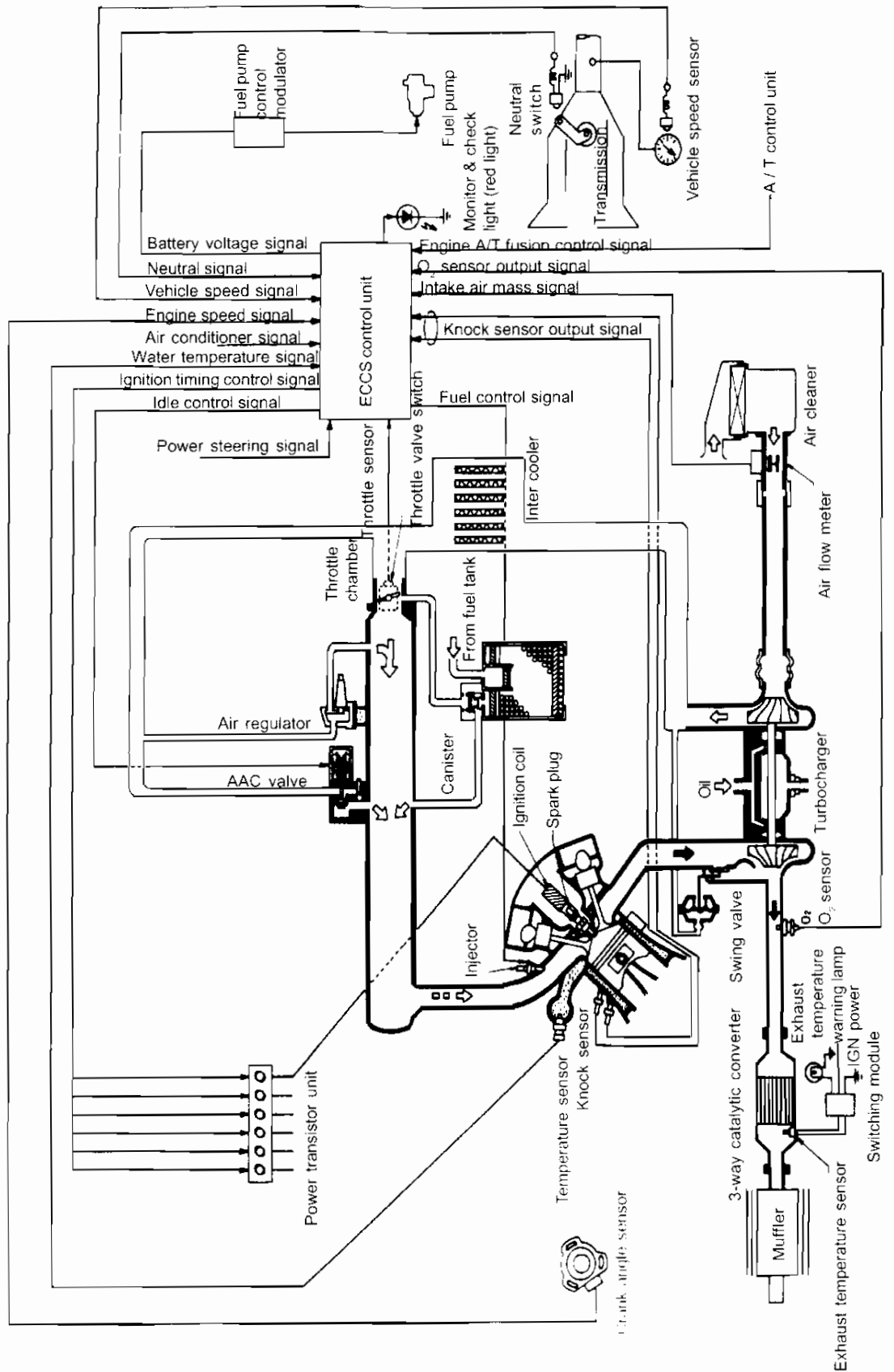

CA18i (ECCS) ENGINE

SYSTEM DIAGRAM  
CA18i (ECCS) ENGINE

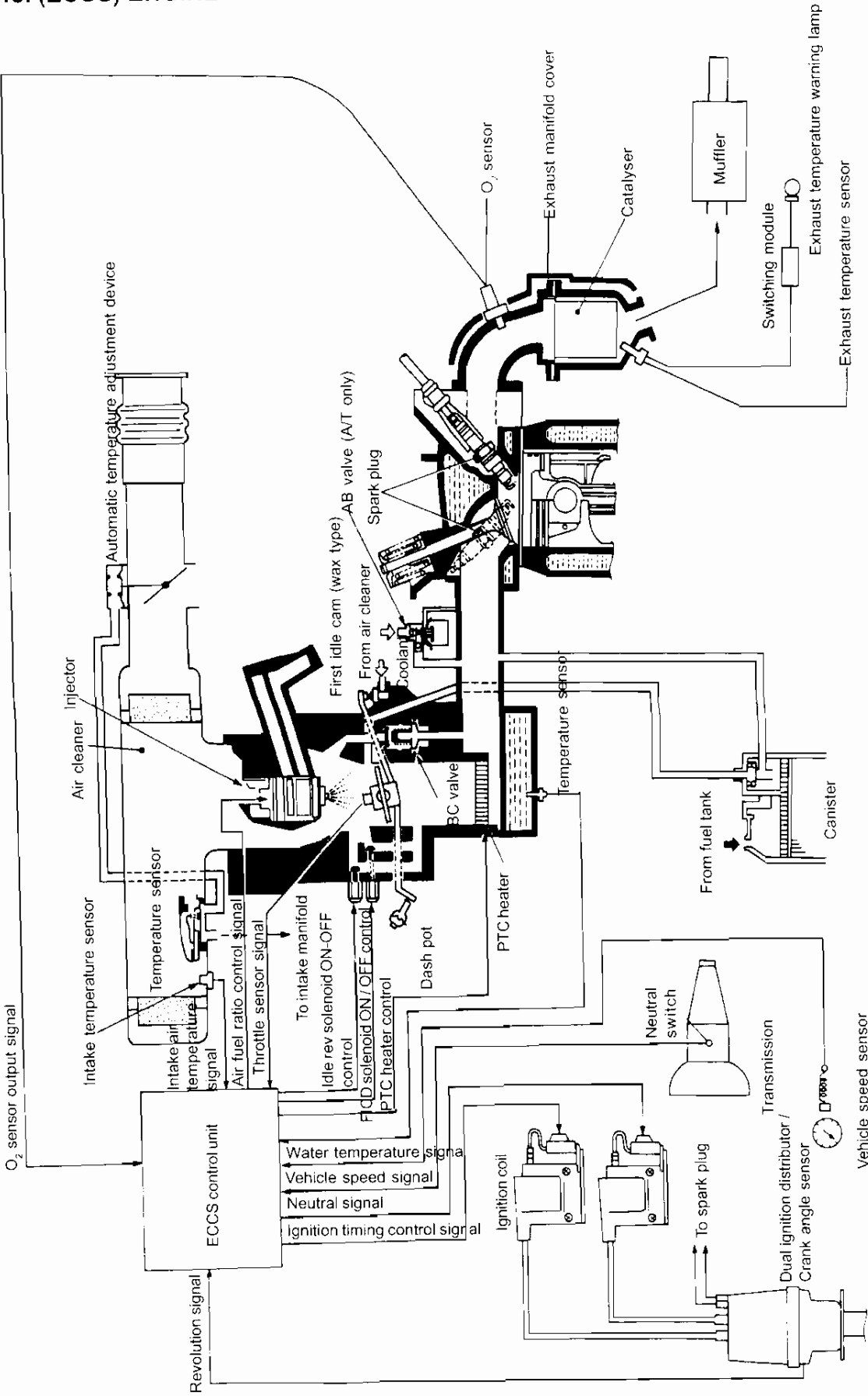

RB25DE ENGINE

SYSTEM DIAGRAM  
RB25DE ENGINE

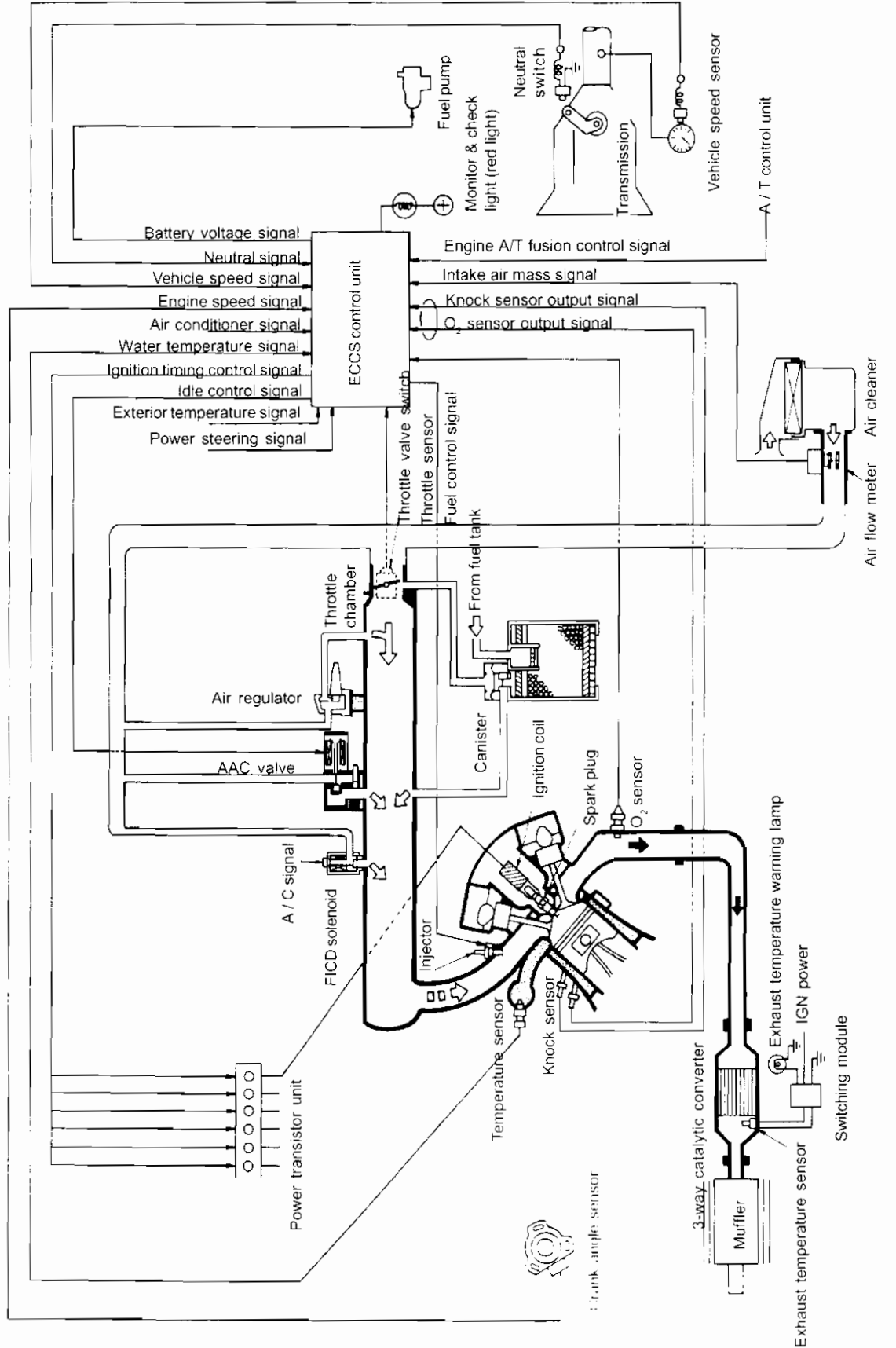

RB26DETT DOHC - EGI (ECCS) TWIN-TURBOCHARGER ENGINE

SYSTEM DIAGRAM

RB26DETT DOHC - EGI (ECCS) TWIN-TURBOCHARGER ENGINE

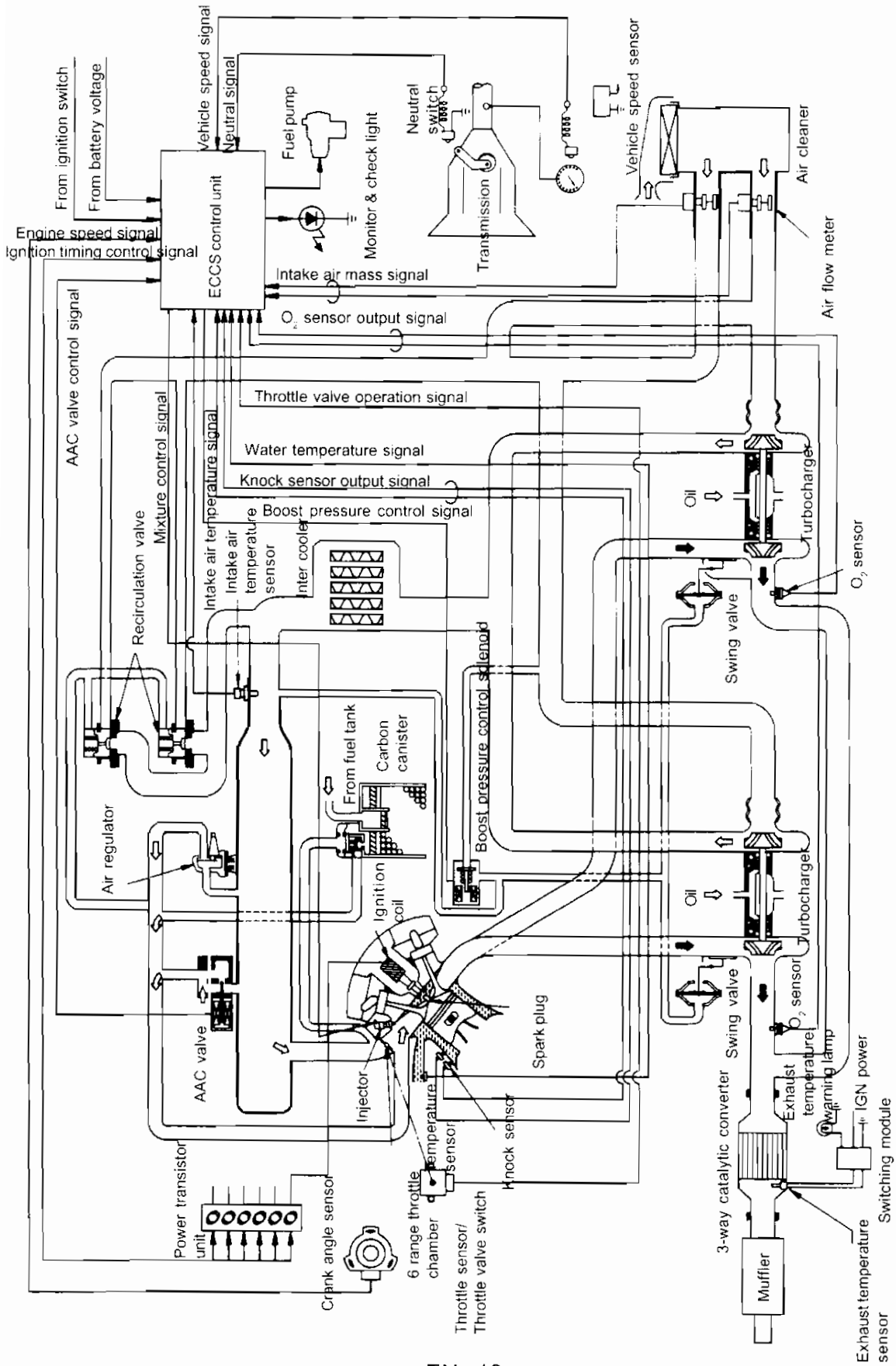

**VACUUM DIAGRAM  
RB20 EGI (ECCS) ENGINE**

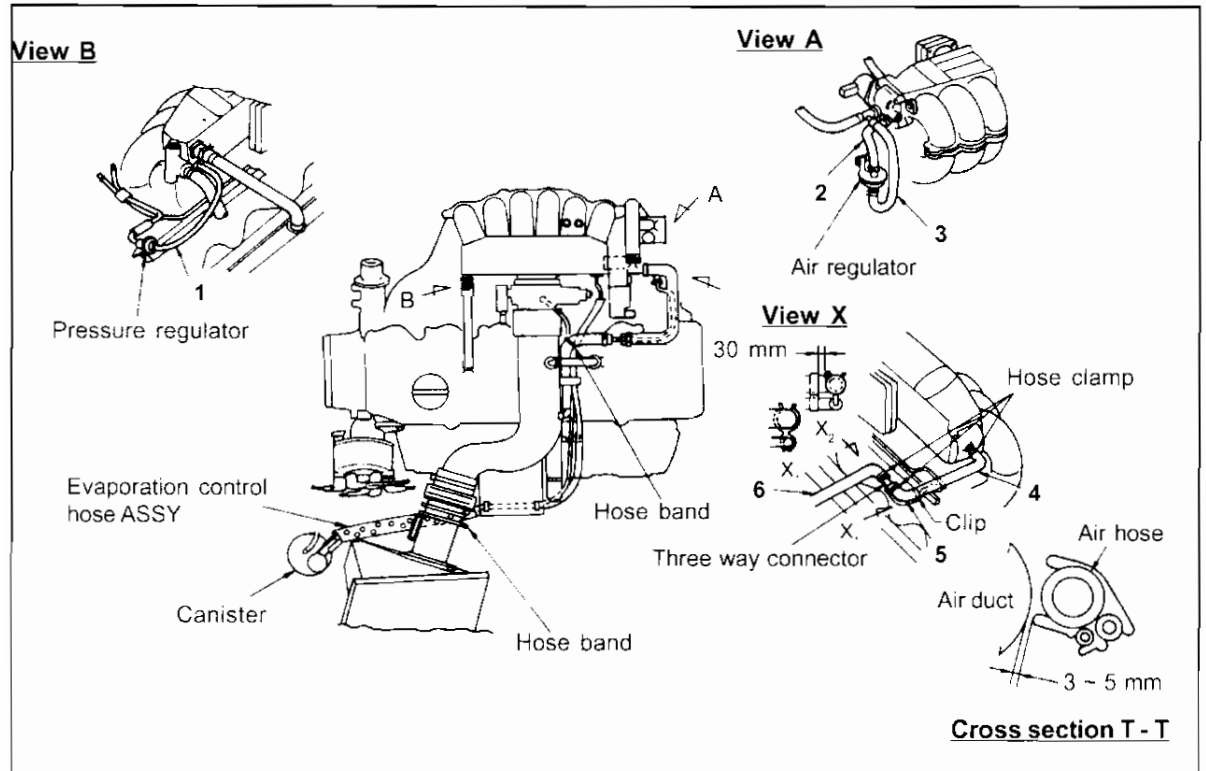

Number	Length (mm)	Part
1	Molded	Intake manifold collector ~ Pressure regulator
2	Molded	Air regulator ~ Intake manifold collector
3	Molded	Air regulator ~ AAC valve
4	Molded	Three way connector ~ Intake manifold collector
5	160	Three way connector ~ Fuel damper
6	Molded	Air duct ~ Three way connector

RB20 DOHC - EGI / RB20 DOHC - EGI TURBOCHARGER ENGINE

RB20 DOHC - EGI (ECCS) ENGINE

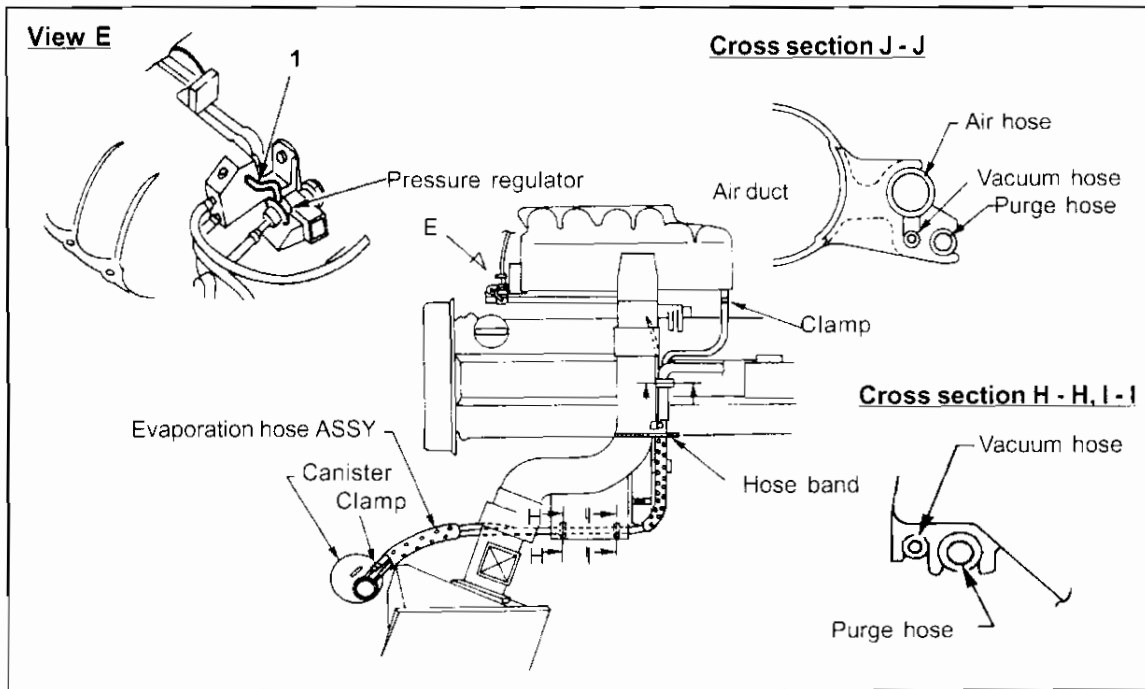

Number	Length (mm)	Part
1	110	Intake manifold collector ~ Pressure regulator

RB20 DOHC - EGI (ECCS) TURBOCHARGER ENGINE

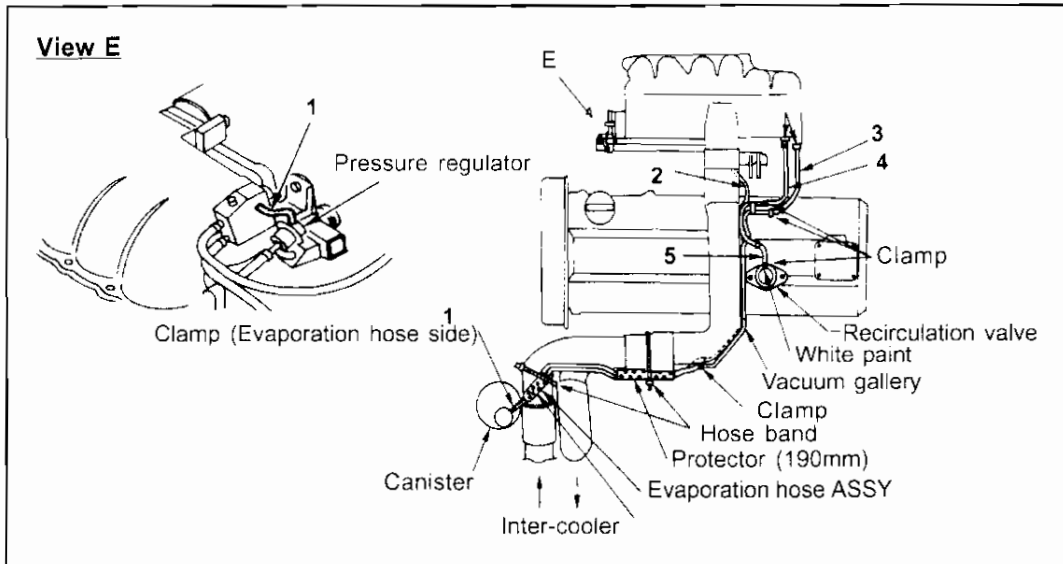

Number	Length (mm)	Part
1	110	Intake manifold collector ~ Pressure regulator
2	80	Throttle chamber ~ Vacuum gallery - ASSY
3	170	Intake manifold collector ~ Vacuum gallery - ASSY
4	170	Intake manifold collector ~ Vacuum gallery - ASSY
5	Molded	Recirculation valve ~ Vacuum gallery - ASSY

CA18i / RB25DE ENGINE

CA18i (ECCS) ENGINE

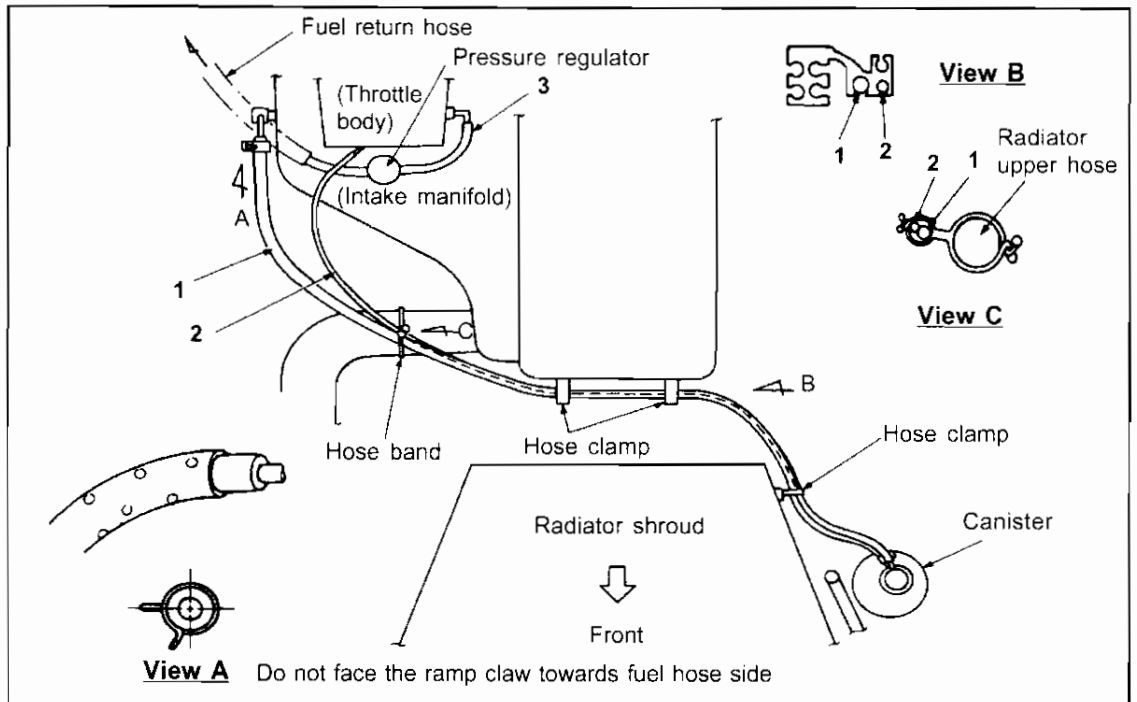

Number	Length (mm)	Part
1	110	Intake manifold ~ Canister
2	80	Throttle body ~ Canister
3	170	Pressure regulator ~ Throttle body

RB25DE ENGINE

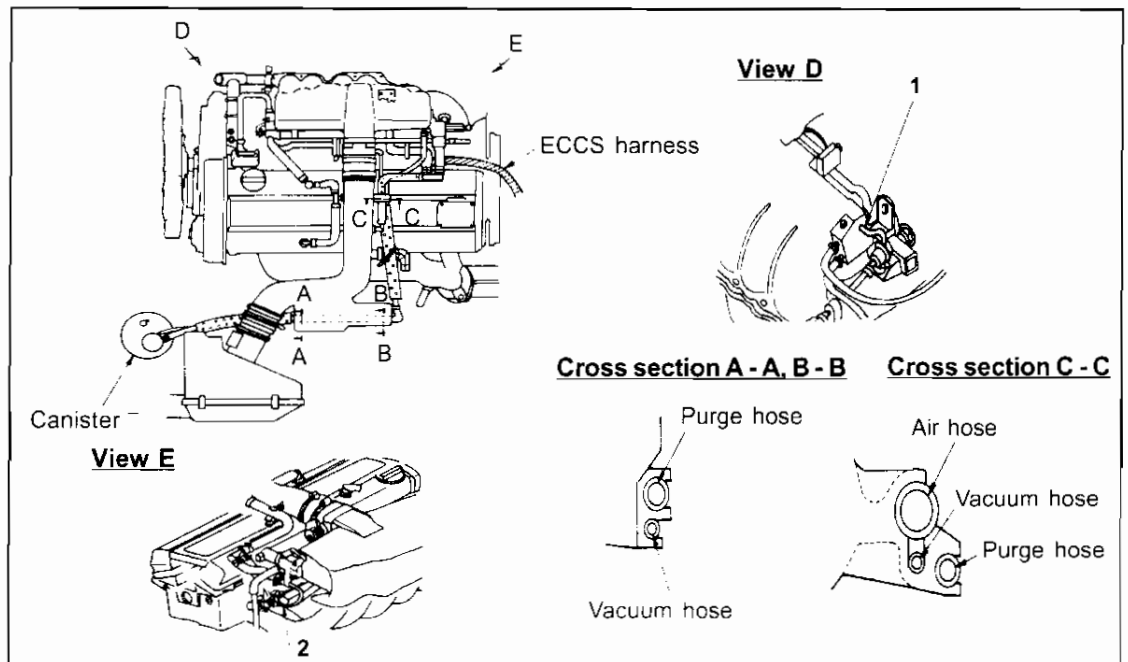

Number	Length (mm)	Part
1	110	Intake manifold collector~ Pressure regulator
2	140	IIA unit connector ~ Fuel damper

RB26DETT DOHC - EGI TWIN TURBOCHARGER ENGINE

RB26DETT DOHC - EGI (ECCS) TWIN TURBOCHARGER ENGINE

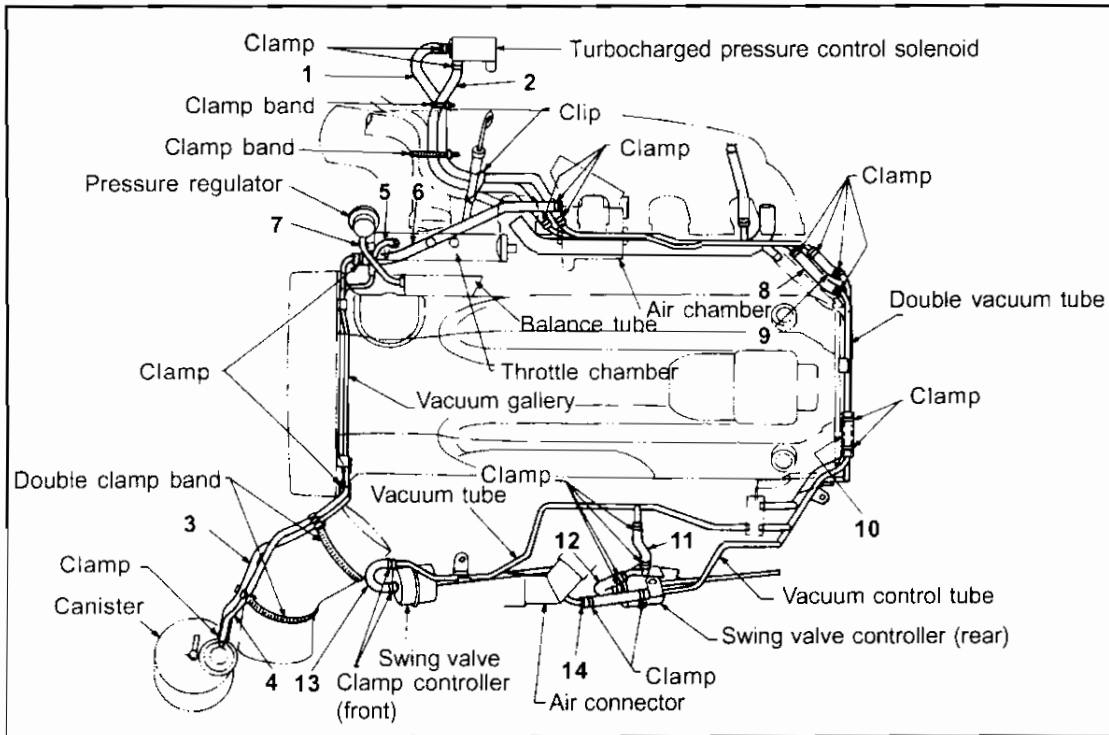

Number	Length (mm)	Part
1	580	Turbocharged pressure control solenoid ~ Vacuum gallery
2	560	Turbocharged pressure control solenoid ~ Vacuum gallery
3	425	Canister ~ Vacuum gallery
4	425	Canister ~ Vacuum gallery
5	80	Throttle chamber ~ Vacuum gallery
6	290	Air chamber ~ Vacuum gallery
7	Molded	Pressure regulator ~ Balance tube
8	120	Vacuum gallery ~ Vacuum gallery
9	90	Vacuum gallery ~ Vacuum gallery
10	60	Vacuum gallery ~ Vacuum gallery
11	90	Vacuum gallery ~ Vacuum gallery
12	Molded	Vacuum gallery ~ Swing valve controller (rear)
13	Molded	Vacuum gallery ~ Swing valve controller (front)
14	90	Vacuum gallery ~ Vacuum control tube



**EN2 RB26DETT / RB20E / DE / DET / RB25DE / CA18i ENGINE**  
**1. IDLE SPEED / IGNITION TIMING / IDLE MIXTURE RATIO INSPECTION**

**Idle standard value**

ENGINE	TRANSMISSION	Idle speed (rpm) (when air condition is ON)	Ignition timing (BTDC° / rpm)	CO / HC density (%) / (PPM)
RB20E	M / T	600 (Approx. 800)	20 / 600	below 0.1 / below 50
	A / T	650 (Approx. 800)	20 / 650	
RB20DE	M / T	600 (Approx. 800)	15 / 650	
	A / T		20 / 650	
RB20DET	M / T	600 (Approx. 800)	15 / 650	
	A / T		20 / 650	
CA18i	M / T	700 (Approx. 850)	13 / 700	
	A / T	800 (Approx. 850)	13 / 800	
RB26DETT	M / T	950 (Approx. 950)	20 / 950	

Caution:

The idle speed, ignition timing, CO and HC density are interrelated. If any adjustments are made to one, additional inspection is required.

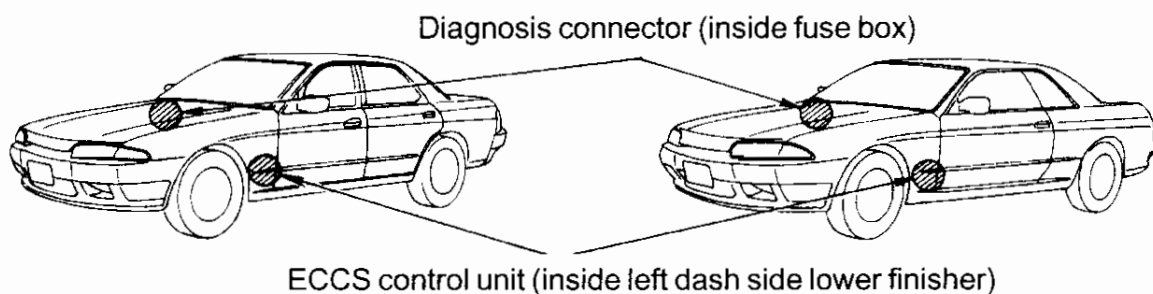

## IDLE SPEED / IGNITION TIMING / IDLE MIXTURE RATIO INSPECTION

### PREPARATION

- Make sure the following parts are in good condition.
  - Battery
  - Ignition system
  - Engine oil and coolant level
  - Fuses
  - Control unit harness connector
  - Vacuum hoses
  - Air intake system (Oil filler cap, oil level gauge, etc.)
  - Fuel pressure
  - Engine compression
  - Throttle valve
- Vehicle fitted with Air conditioner should have the A / C switch in OFF position.
- When checking idle speed, ignition timing and mixture ratio of A / T models, place the shift lever in "N" position.
- Insert the probe approx. 40 cm (15.7 in) into rail pipe when measuring CO percentage.
- Turn OFF the headlight, heater blower and rear defogger.
- Keep the steering wheel straight.
- Recharge the CONSULT sufficiently when using consult and connect to the vehicle side diagnosis connector.

### INSPECTION SEQUENCE

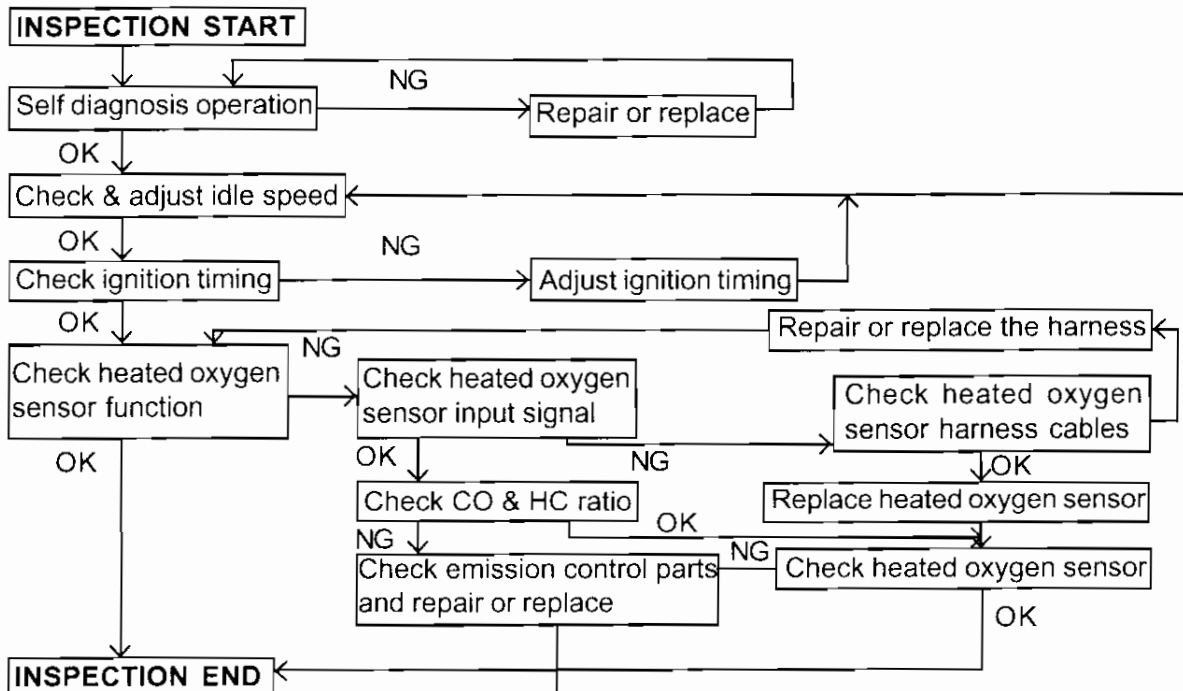

### RB26DETT Engine Idle inspection & adjustment

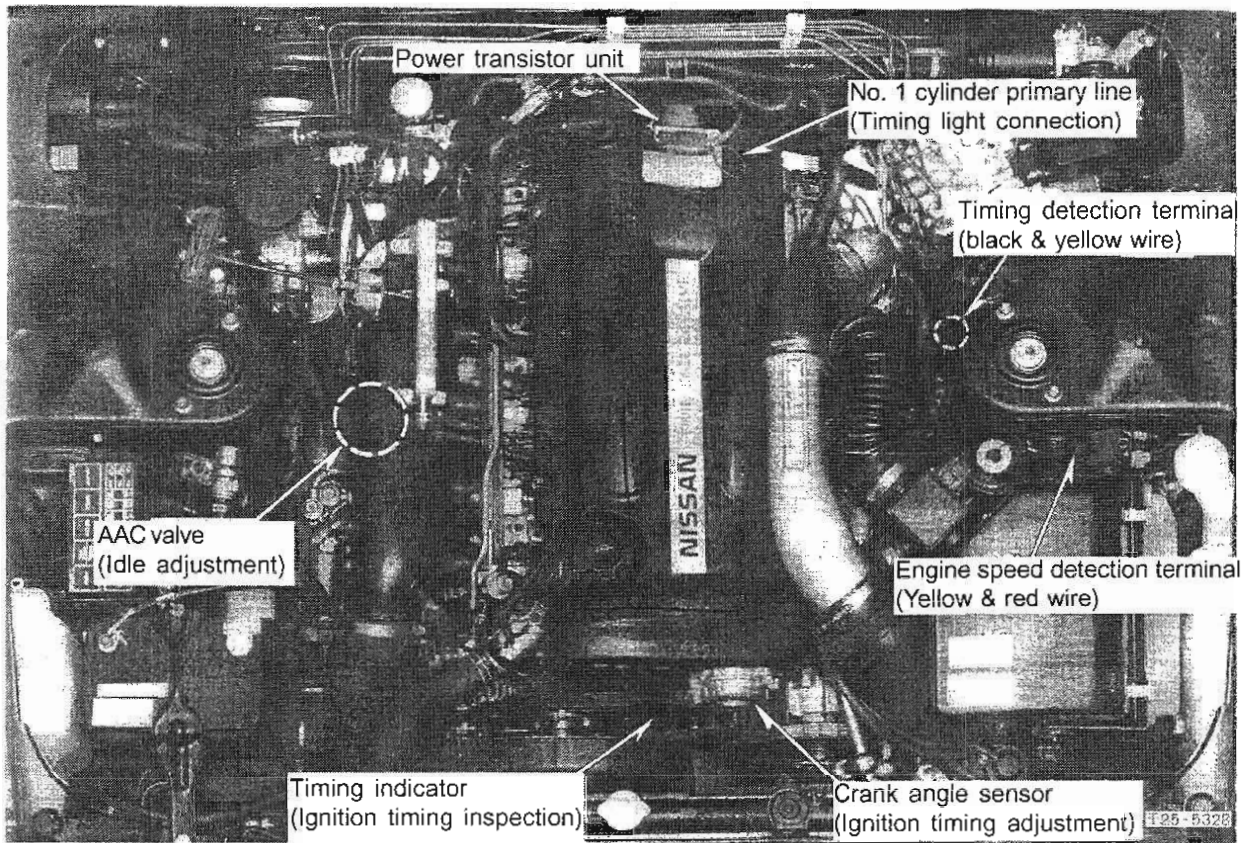

### CA18i Engine Idle inspection & adjustment

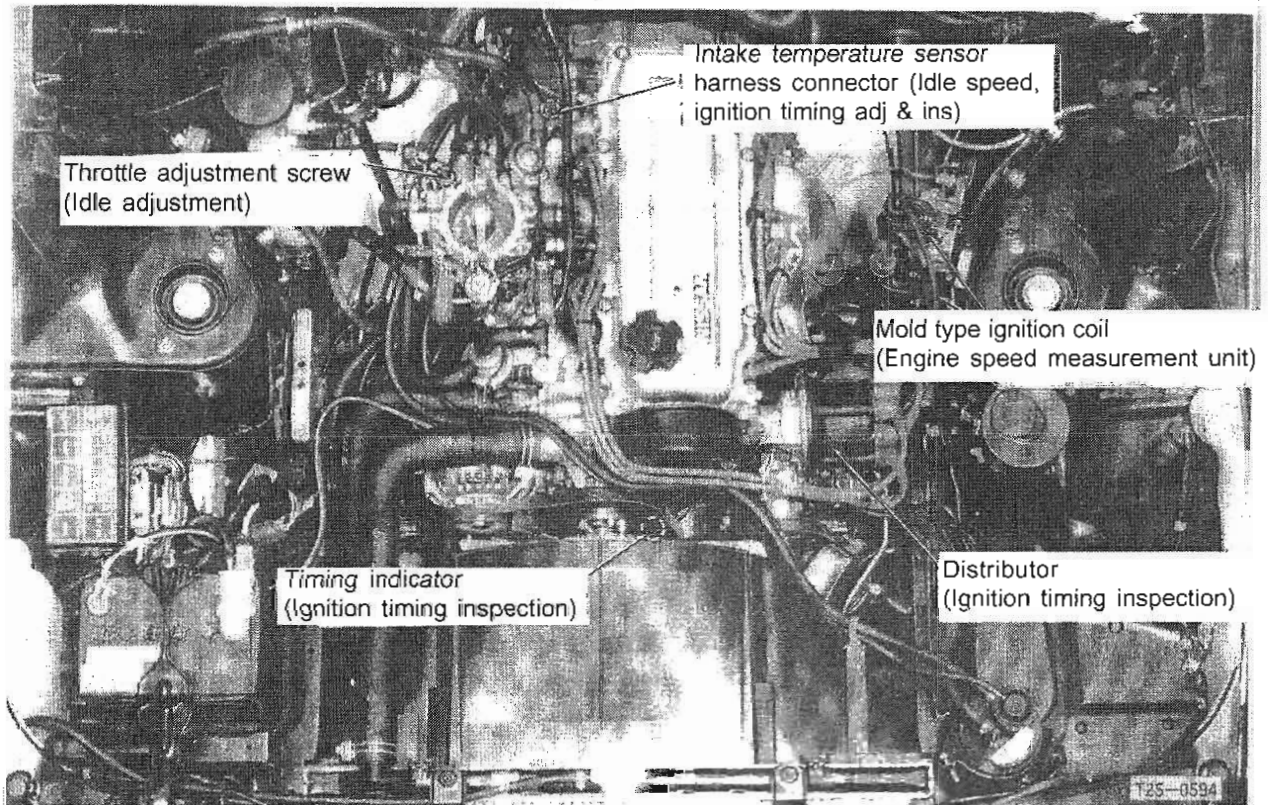

IDLE SPEED / IGNITION TIMING / IDLE MIXTURE RATIO INSPECTION  
RB20E / RB20DE ENGINE

**RB20E Engine Idle inspection & adjustment**

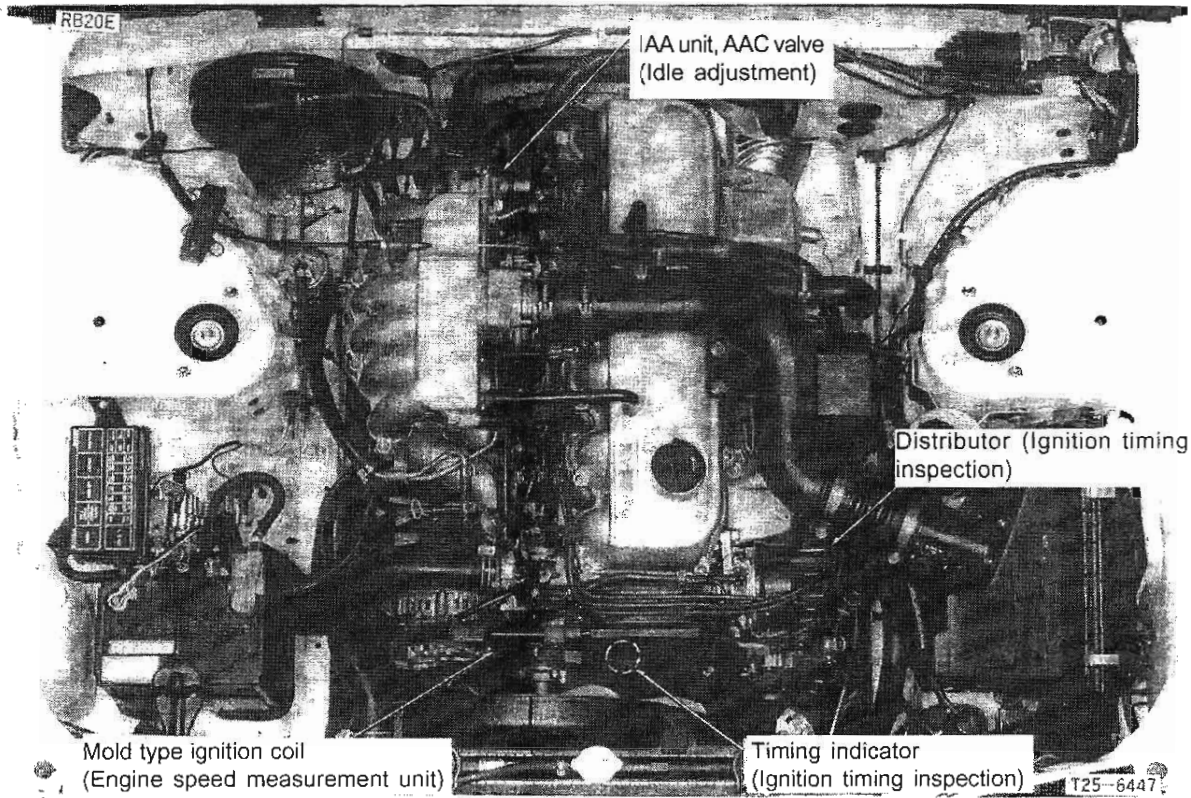

**RB20DE Engine Idle inspection & adjustment**

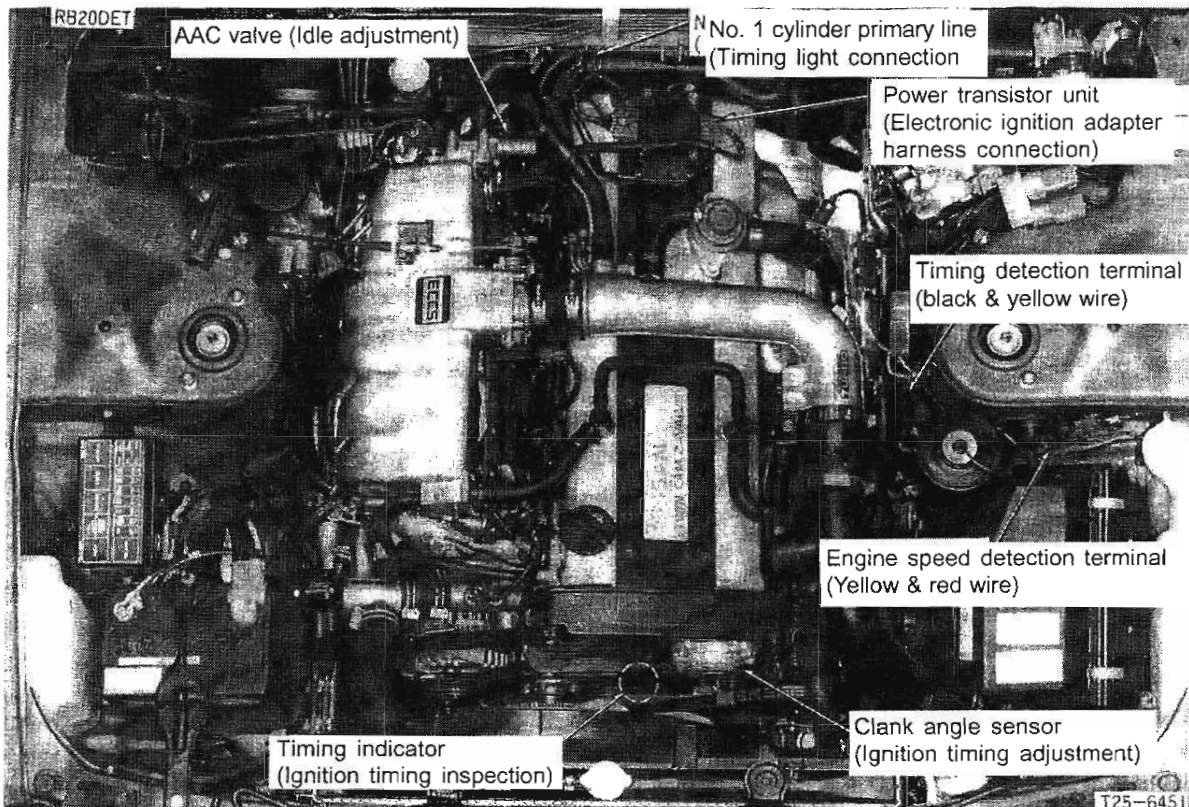

**RB20DET Engine Idle inspection & adjustment**

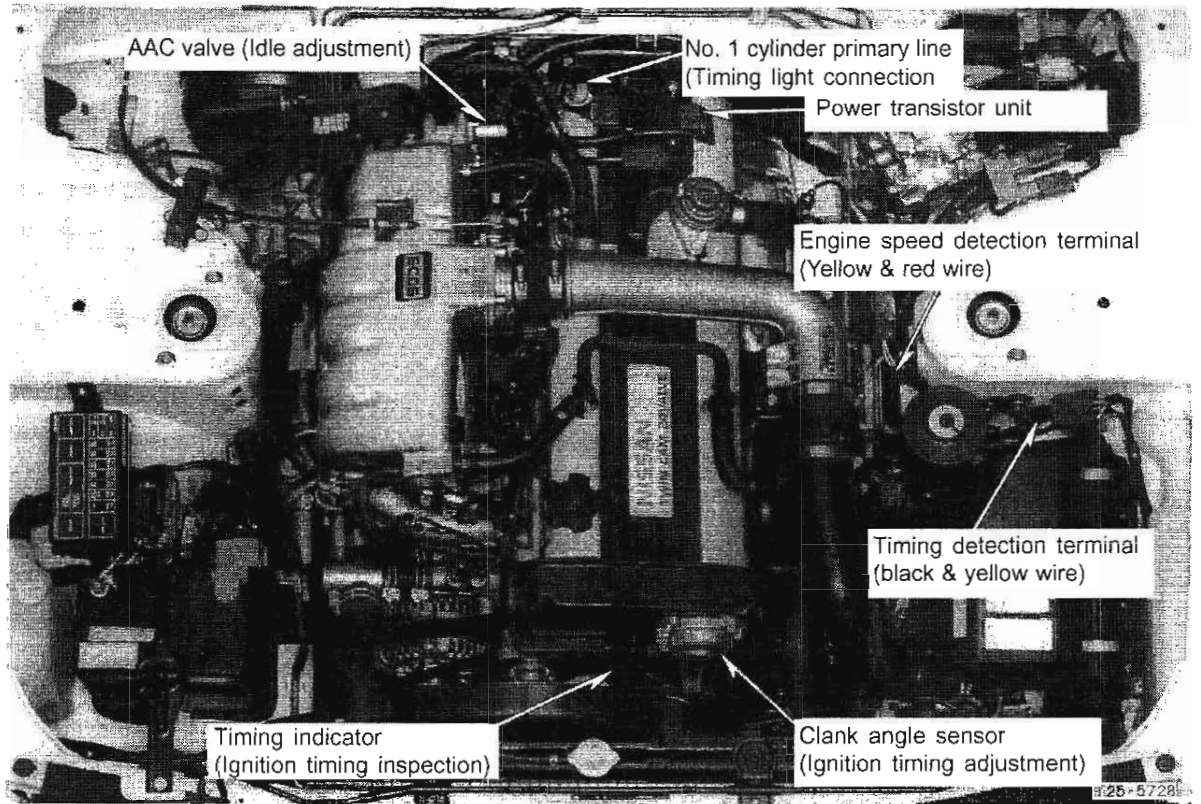



IDLE SPEED / IGNITION TIMING / IDLE MIXTURE RATIO INSPECTION  
RB26DETT / RB20DE / DET ENGINE

**Idle inspection & adjustment (RB26DETT / RB20DE, DET)**

**Engine speed measurement unit**

- Warm the engine sufficiently.
- Connect CONSULT to diagnosis Connector on vehicle (attached to fuse block area). Place the ignition to ON position.
- Display the "Diagnosis mode selection".

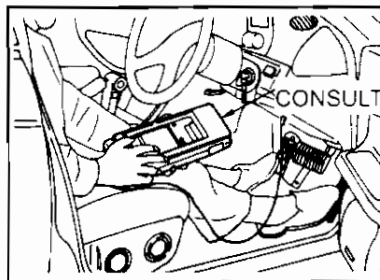

- Connect the measurement unit to speed detection terminal in the harness connected to the ignition coil from the power transistor.
- When the measurement is complete, always replace the terminal cap in the detection area.



**RB20DE, DET**

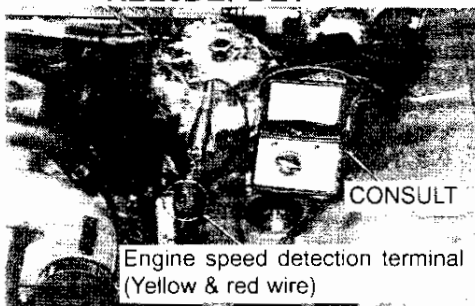

**RB26DETT**

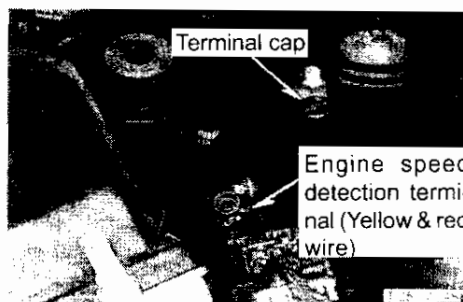

**Inspection**

- Warm the engine sufficiently.
- Make sure the air conditioning load, power steering oil pump load and electrical loads are not applied. Place the select lever in 'N' for automatic vehicles.
- Check the "IDLE POS" and "CAS-RPM" in data monitor mode in CONSULT.
- Carry out the inspection using engine speed measurement.

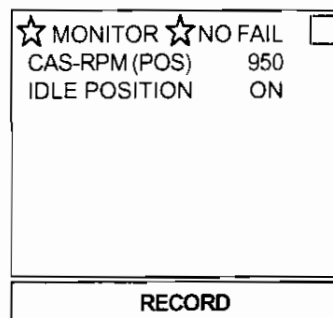

Note:

The measurement unit is limited as the speed output voltage is low (approx. 6V Vp-p).

Caution:

Before the inspection, make sure the throttle valve switch (idle connection point) is turned ON when the accelerator pedal is not pressed.

**Adjustment**

The idle speed adjustment is basically not necessary as the rated value (control target value) is returned to the control unit. If adjustment becomes necessary, carry out the following procedures.

- Select "AAC valve adjustment" in "WORK SUPPORT" mode. Turn the AAC valve assembly idle adjustment screw with a screwdriver until idle speed is 900 rpm (RB26DETT) 600 rpm (RB20DE, DET).
- Return "AAC valve adjustment" screen to "DATA monitor" and check if the idle speed shown meets the specification.

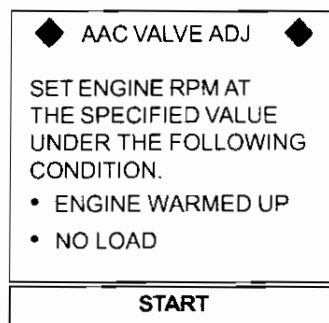

IDLE SPEED / IGNITION TIMING / IDLE MIXTURE RATIO INSPECTION

RB26DETT / RB20DE / DET ENGINE

- Make sure the ECCS control unit idle control adjustment volume is turned all the way to left.



**Caution:**

Do not turn the idle control speed adjustment volume with excessive force. The adjustment screw turning range is 3/4 of a turn.

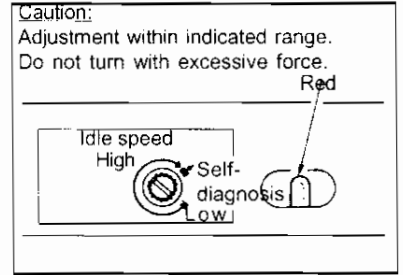

- Remove the 2-pin harness connector from the AAC valve to stop the idle speed feedback control. At this time the AAC valve is completely closed and the idle speed should be below 900 rpm (RB26DETT) 600 (RB20DE, DET) under normal condition.

**RB26DETT**

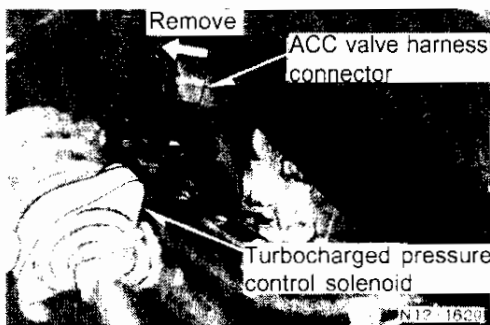

**RB20DE, DET**

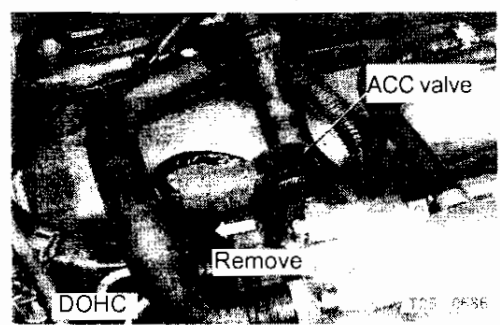

- Turn the AAC valve ASSY idle adjustment screw with a screw driver to adjust engine speed to 900 rpm (26DETT), 600 rpm (20DE, DET).
- Connect the AAC valve harness connector and make sure the idle speed is maintained at specified value.
- The engine speed increases when the adjustment screw is turned to left (CCW) and decreases when turned to right (CW).

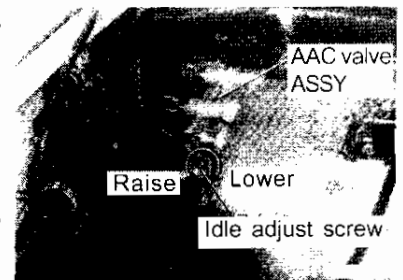

- If you wish to increase idle speed for any reason, turn the idle adjustment volume in ECCS control unit to adjust the speed. Idle adjustment speed increases when the knob is turned clockwise by a maximum of 250 rpm.

**Caution:**

The adjustment volume must be set 40° ~ 50° away from the self-diagnosis position as if it is turned all the way to the right (self-diagnosis position), the idle speed is lowered (lowest rpm + 50 rpm).

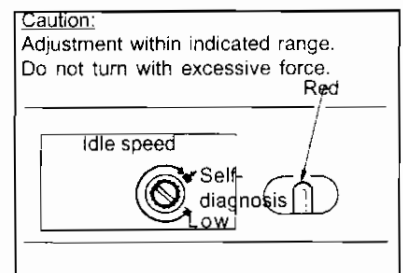

## IGNITION TIMING CHECK & ADJUSTMENT (RB26DETT / RB20DE, DET)

### 1. When using "Super tuner"

Connect super tuner to timing detection terminal.

#### Caution:

After the operation is completed, always attach terminal cap to timing detection terminal.

**RB26DETT**

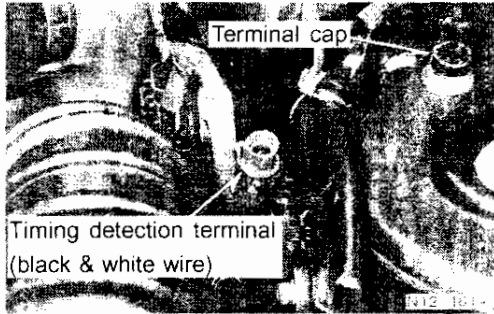

**RB20DE, DET**

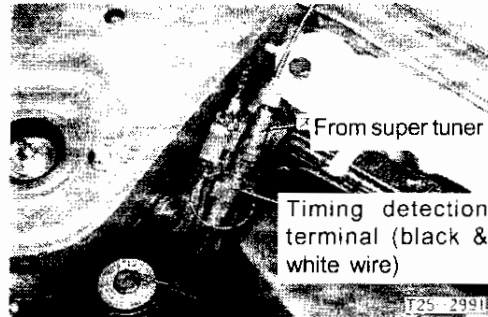

### 2. Using primary current detector timing light

- When using EG1443 0001 or EG1444 0000 connect the sensor to No. 1 cylinder primary line. (No. 1 cylinder primary line is looped as it is longer than other cylinder primary lines).

#### Caution:

When using EG1444 0000 (internal battery model), make sure that the sensor direction (arrow direction) faces spark plug when sensor is clipped to the primary line.

**RB26DETT**

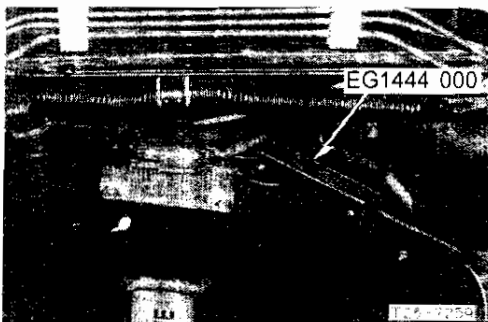

**RB20DE, DET**

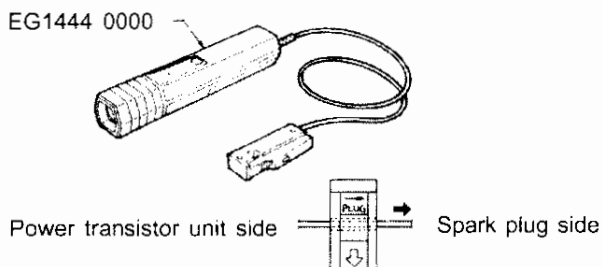
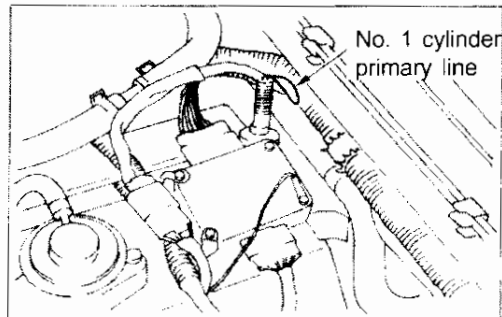



IDLE SPEED / IGNITION TIMING / IDLE MIXTURE RATIO INSPECTION  
RB26DETT / RB20DE / DET ENGINE

**Inspection**

- Make sure the idle speed is at standard value.
- Make sure the ignition timing at engine idle is at standard specification.
- Make sure ignition advances to correct advance angle when the engine is raced.

**Caution:**

The 0° timing mark on the crank pulley is orange and other points are painted white.

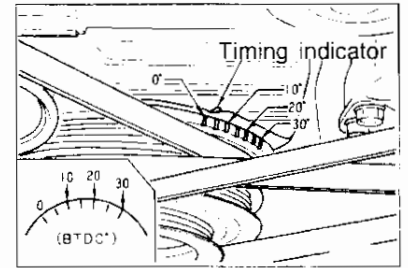

**Adjustment**

Since there is no variation in ignition timing, over an extended time period, ignition adjustment is not necessary in principle. Adjust ignition timing when the crank angle sensor is connected.

- Set the ignition timing by adjusting the crank angle sensor installation position.
- Make sure the idle speed is at standard.
- Loosen the three crank angle sensor mounting bolts and rotate crank angle sensor. Turn the sensor to left to advance ignition timing.
- After the adjustment, attach the sealing tape to one of the three bolts that secure the crank angle sensor.  
Sealing tape part number: B2235 U7410

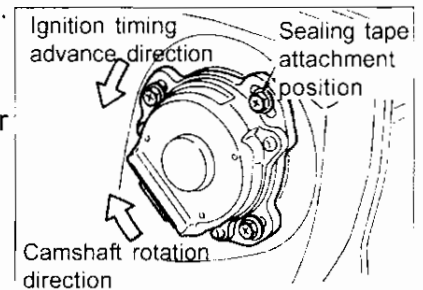

**Idle inspection & adjustment (CA18i / RB20E)**

**Engine speed measurement unit**

- Warm the engine sufficiently.
- Connect CONSULT to diagnosis connector on vehicle (attached to fuse block area). Place the ignition to ON position.
- Display the "Diagnosis mode selection".

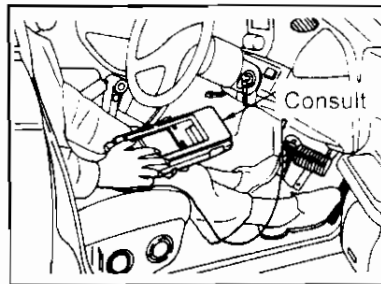

- Connect the measurement unit to the speed detection terminal by connecting the adapter harness for the mold coil between the coil primary terminal and the primary terminal harness connector.

**CA18i**

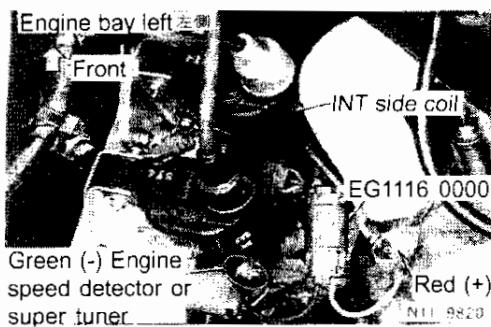

**RB20E**

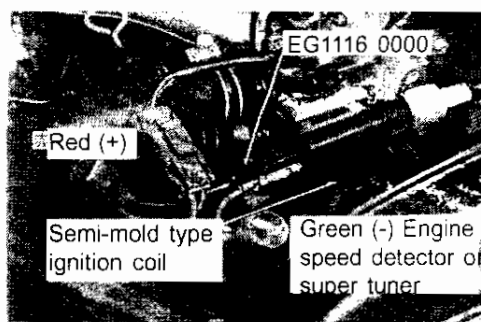

**Inspection**

- Warm the engine sufficiently.
- Make sure the air conditioning load, power steering oil pump load and electrical loads are not applied. Place the select lever in 'N' for automatic vehicles.
- Check the "IDLE POS" and "CAS-RPM" in data monitor mode in CONSULT.
- Carry out the inspection using engine speed measurement.



☆ MONITOR ☆	NO FAIL	<input type="checkbox"/>
CAS-RPM (REF)	675rpm	
AIR FLOW METRE	1.04v	
WATER TEMP	79C	
O2 SENSOR	0.11v	
THROTTLE SENSOR	0.40V	
IDLE SW	ON	
<b>RECORD</b>		



**Caution:**

Before the inspection, make sure the throttle valve switch (idle connection point) is turned ON when the accelerator pedal is not pressed.

**Adjustment**

**RB20E Engine**

The idle speed adjustment is basically not necessary as the rated value (control target value) is returned to the control unit. If adjustment becomes necessary, remove the ECCS control unit and carry out the following procedures.

- Select "AAC valve adjustment" in the "WORK SUPPORT" mode. Turn the AAC valve assembly idle adjustment screw with a screwdriver until idle speed is 600 rpm (M / T) 650 rpm (A / T).
- Return the "AAC valve adjustment" screen to "DATA monitor" and check if the idle speed shown meets the specification.



◆ AAC VALVE ADJ ◆	
SET ENGINE RPM AT THE SPECIFIED VALUE UNDER THE FOLLOWING CONDITION.	
<ul style="list-style-type: none"> <li>• ENGINE WARMED UP</li> <li>• NO LOAD</li> </ul>	
<b>START</b>	

IDLE SPEED IGNITION TIMING / IDLE MIXTURE RATIO INSPECTION  
CA18i / RB20E ENGINE

- Make sure the ECCS control unit idle control adjustment volume is turned all the way to the left.

**Caution:**

Do not turn the idle control speed adjustment volume with excessive force. The adjustment screw turning range is 3 / 4 of a turn.

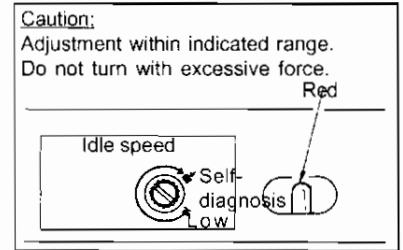

- Turn the ISS unit idle adjustment screw with a screwdriver to adjust the engine speed to 600 rpm (M / T), 650 (A / T).
- Connect the throttle sensor harness connector. Make sure idle speed is maintained at the specific value.

- If you wish to increase idle speed for any reason, adjust the volume in ECCS control unit.

**Caution:**

The adjustment volume must be set 40° ~ 50° away from the self-diagnosis position as if it is turned all the way to the right (self-diagnosis position), the idle speed is lowered (lowest rpm + 50 rpm).

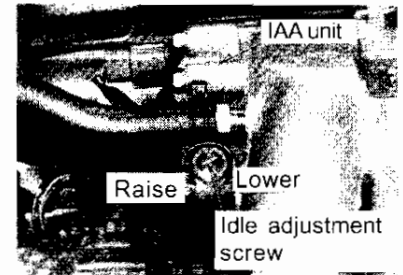

**Adjustment**

**CA18i Engine**

- Remove the harness connector from the intake temperature sensor to stop the feedback system of the ignition timing and air - fuel ratio.
- Adjust the engine revolution to 700 rpm (M / T), 800 (A / T) by throttle adjustment screw.
- Connect the harness connector for the intake air temperature sensor and make sure the idle speed is maintained at the specified value.

**Caution:**

The adjustment volume on the control unit side can not be used for fine adjustment.

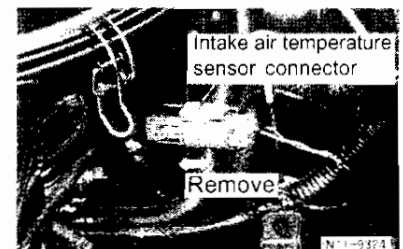

## IGNITION TIMING CHECK & ADJUSTMENT (RB20E / CA18i)

### Timing light attachment

- Connect the timing light using the adapter harness for hold coil for the timing light that collects the signal from the super tuner.
- For normal timing light connect the sensor to No. 1 Hightension cable.

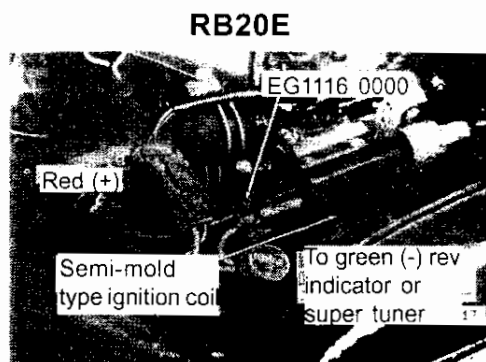
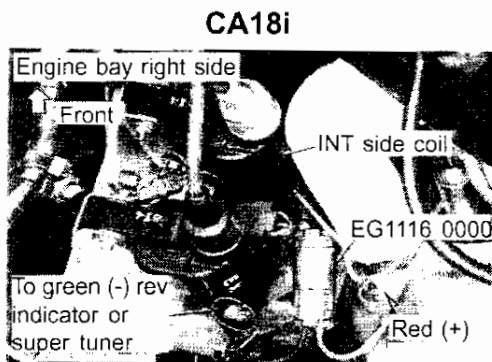

### Inspection RB20E



- Do not carry out the inspection as this may cause ignition timing to become unstable.

◆ IGNITION TIMING ◆

WHILE IDLING PRESS "START" AND STOP THE IGNITION TIMING FEEDBACK CONTROL. ROTATE THE CRANK ANGLE SENSOR AND ADJUST BY USING THE TIMING LIGHT.

START

☆ MONITOR ☆ NO FAIL

CAS-RPM (REF)	675 rpm
WATER TEMP	79°C
IGNITION TIMING	158TBC

RECORD



- Make sure the idle speed is at standard value.
- Make sure ignition timing at engine idle is at standard specification.
- Make sure ignition advances to correct advance angle when engine is raced.

### Caution:

The 0° timing mark on the crank pulley is orange and other points are painted white.

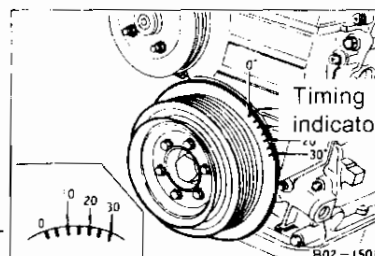

**Inspection**

**CA18i engine**

- In the "Ignition timing adjustment" in "Operation support" mode and check the ignition timing.



◆ IGNITION TIMING ◆

WHILE IDLING PRESS "START" AND STOP THE IGNITION TIMING FEEDBACK CONTROL. ROTATE THE CRANK ANGLE SENSOR AND ADJUST BY USING THE TIMING LIGHT.

---

START

- Remove the harness connector for the intake temperature sensor and fix the timing advance to inspect the ignition timing.

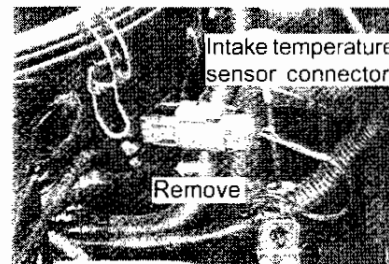

- Make sure ignition timing at engine idle is at standard specification.

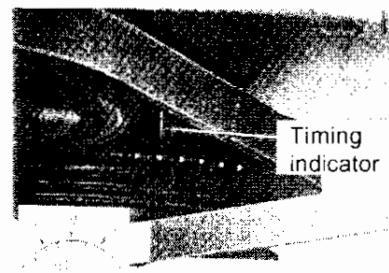

**Adjustment**

**RB20E engine**

- Adjust the ignition timing by adjusting the distributor placement position.
- Make sure idle speed is standard.
- Remove the throttle sensor connector.
- Loosen the crank angle sensor mounting bolts and rotate crank angle sensor. Turn the sensor to left to advance ignition timing.
- After the adjustment, attach sealing tape to the bolts that secure the distributor.

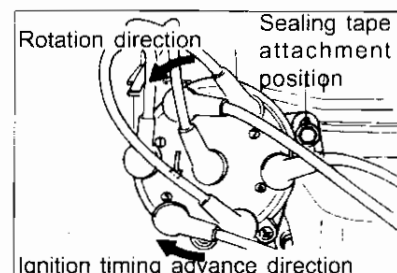

**CA18i engine**

- Adjust the ignition timing by adjusting the distributor placement position.
- Make sure idle speed is standard.
- Loosen the crank angle sensor mounting bolts and rotate crank angle sensor. Turn sensor to left to advance ignition timing.
- After adjustment, attach sealing tape to the bolts that secure the distributor.

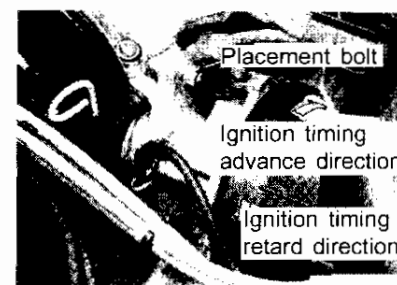

Sealing tape part number: B2235 U7410

**IDLE MIXTURE RATIO (CA18i / RB20E / DE / DET / RB26DETT) INSPECTION**

The air-fuel ratio feedback system which has a self-learning function is used and CO and HC density adjustment is not necessary as the correction range is wide.

**Inspection**

- Warm up the engine sufficiently and make sure the idle speed and the ignition timing are at standard measure. Check CO and HC density with CO and HC meter.
- If the values do not conform to standard measure, perform following procedures to inspect the air / fuel feedback condition:
- In the data monitor mode, select "Exhaust gas sensor monitor" and "Exhaust gas sensor monitor (R)".
- Set the engine speed above 1000 rpm (2000 rpm for RB26DETT engine) and make sure "RICH" and "LEAN" are displayed alternately.
- Short-circuit the self-diagnosis connector on the vehicle side (near fuse box installation). Or remove the ECCS control unit and operate adjustment volume on the control unit side.

☆ MONITOR ☆	NO FAIL	<input type="checkbox"/>
CAS-RPM (POS)	950 rpm	
EXH GAS SEN	123V	
EXH GAS SEN-R	110V	
M/R F/C MNT	R CH	
M/R F/C MNT-R	RICH	

**RECORD**

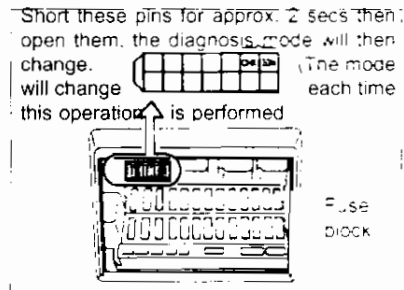

- Place the ignition to "ON" position and use a lead line to short circuit the CHK pin and IGN pin of the diagnosis connector for more than two seconds to release the settings. (Or otherwise turn the ignition switch to "ON" and turn the adjustment volume on the side of the ECCS control unit to the right (CW) until it stops in the self diagnosis mode switching position B for more than two seconds and then return it to the original position.

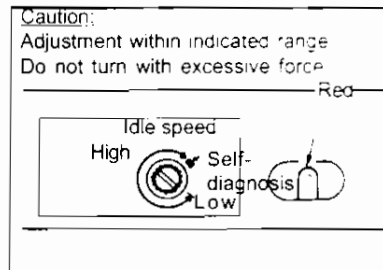

- After warming up the engine sufficiently, raise the engine speed until the exhaust gas temperature warning lamp (or the red lamp on side of the control unit) flashes (the flashing will start above approx. 2000 rpm). The rear exhaust gas sensor output monitor mode will be set.

**Caution:**

The accelerator pedal must be pressed intentionally during idling to perform the inspection as the air fuel ratio feedback control is stopped.

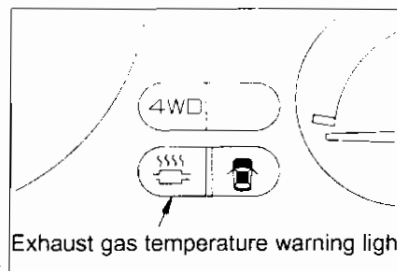

**IDLE MIXTURE RATIO INSPECTION (CONT'D FOR RB26DETT)**

- Use a lead to short-circuit the CHK pin and the IGN pin of the diagnosis connector for more than two seconds one more time to release the self-diagnosis mode. (Otherwise turn the adjustment volume of the ECCS control unit side to the right (CW) until it stops to select the self-diagnosis mode B for more than two seconds and then return it to the original position).

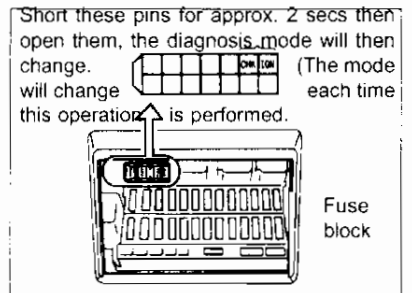

**Exhaust gas sensor monitor mode switching display**

- Set the ignition switch to "ON". Use a lead line to short CHK pin and IGN pin of diagnosis connector for more than two seconds to switch mode. (Otherwise turn ignition switch to "ON" and turn adjustment volume on side of the ECCS control unit to the right (CW) until it stops self-diagnosis mode switching position B for more than two seconds and then return volume to original position.

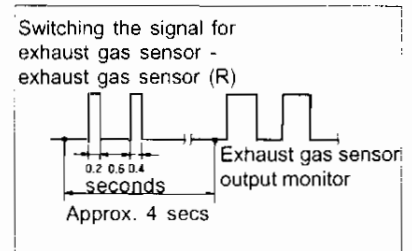

- After warming the engine sufficiently, raise the engine speed until the exhaust gas temperature warning lamp (or the red lamp on the side of the control unit) flashes (the flashing will start above approx. 2000 rpm). The rear exhaust gas sensor output monitor mode will be set.

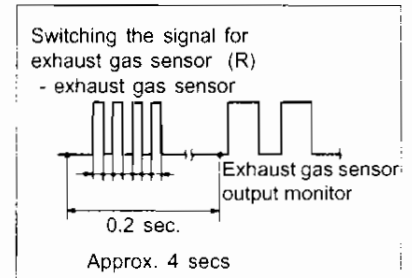

**Caution:**

The accelerator pedal must be pressed intentionally during idling to perform the inspection as the air-fuel ratio feedback control is stopped.

- Make sure the exhaust gas temperature warning lamp or the red lamp on the side of the control unit flashes in this condition.
- Short-circuit CHK pin and IGN pin of the diagnosis connector for more than two seconds to release the mode.
- Make sure that the exhaust gas temperature warning lamp flashes at about 2000 rpm.

**IDLE SPEED / IGNITION TIMING / IDLE MIXTURE RATION INSPECTION  
(RB25DE ENGINE)**

**INSPECTION & ADJUSTMENT**

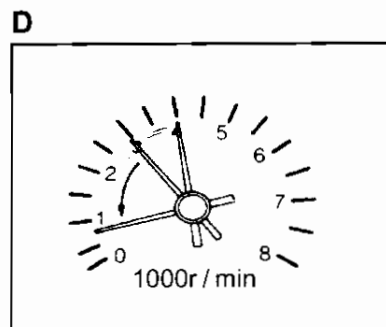
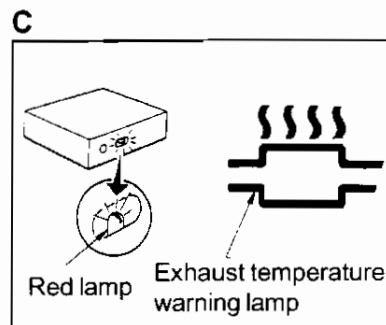
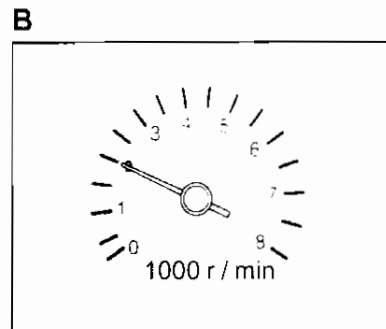
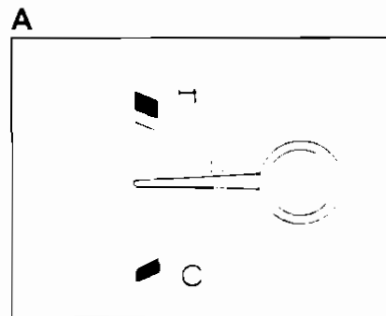
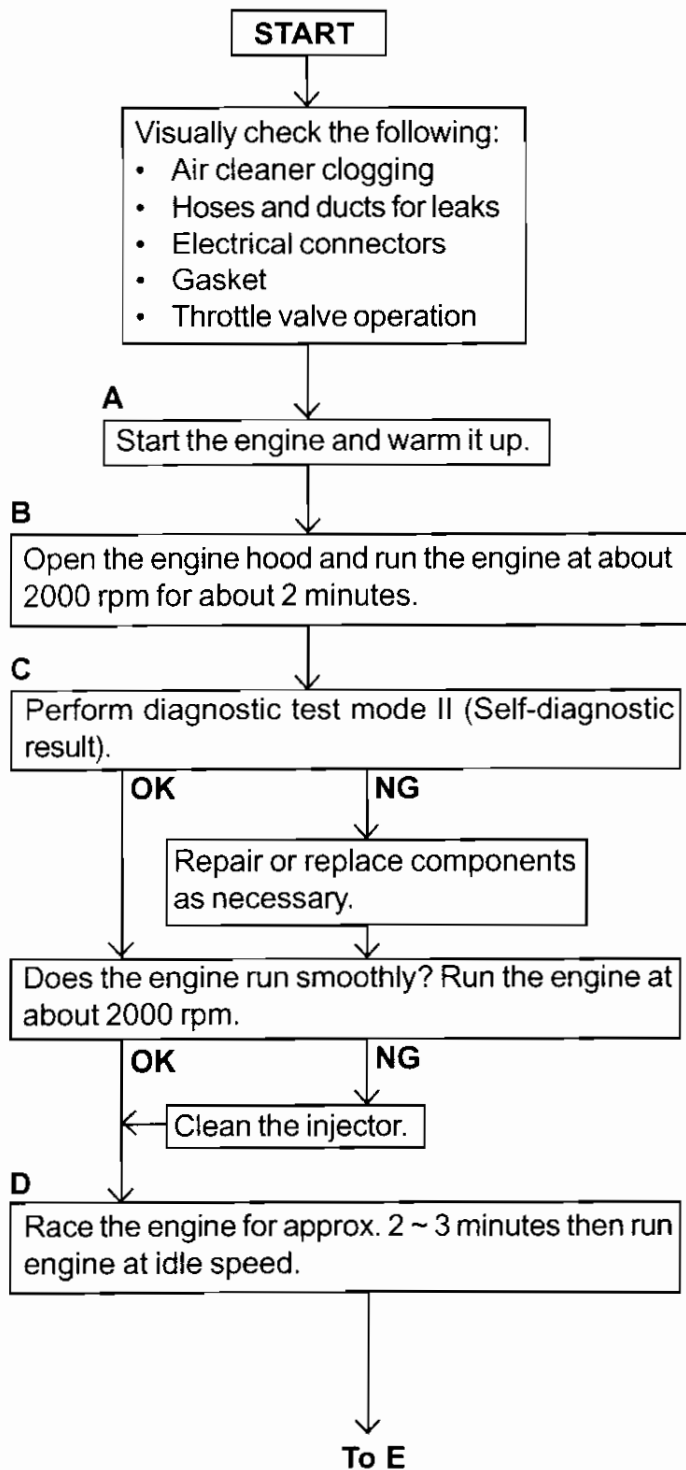



IDLE SPEED / IGNITION TIMING / IDLE MIXTURE RATIO INSPECTION

RB25DE ENGINE

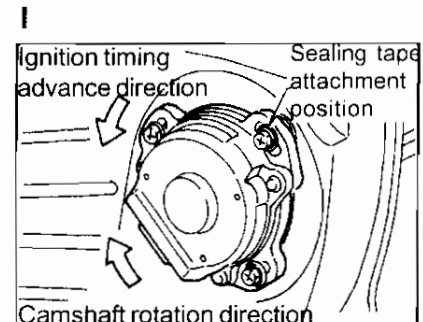
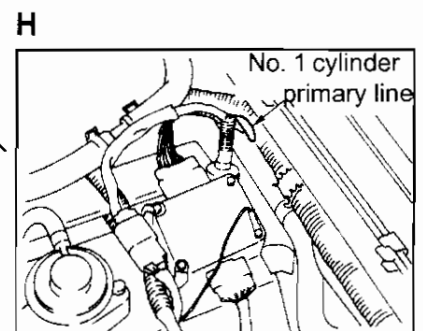
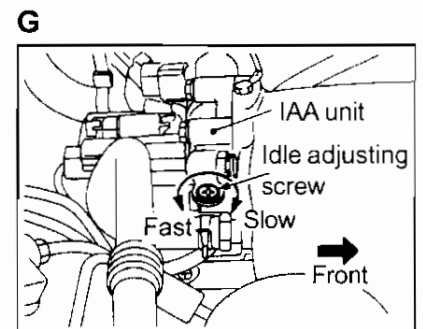
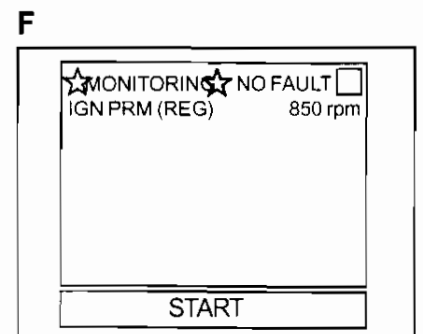
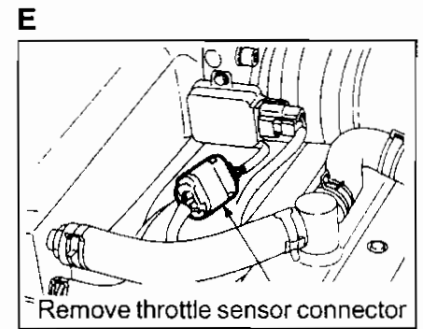
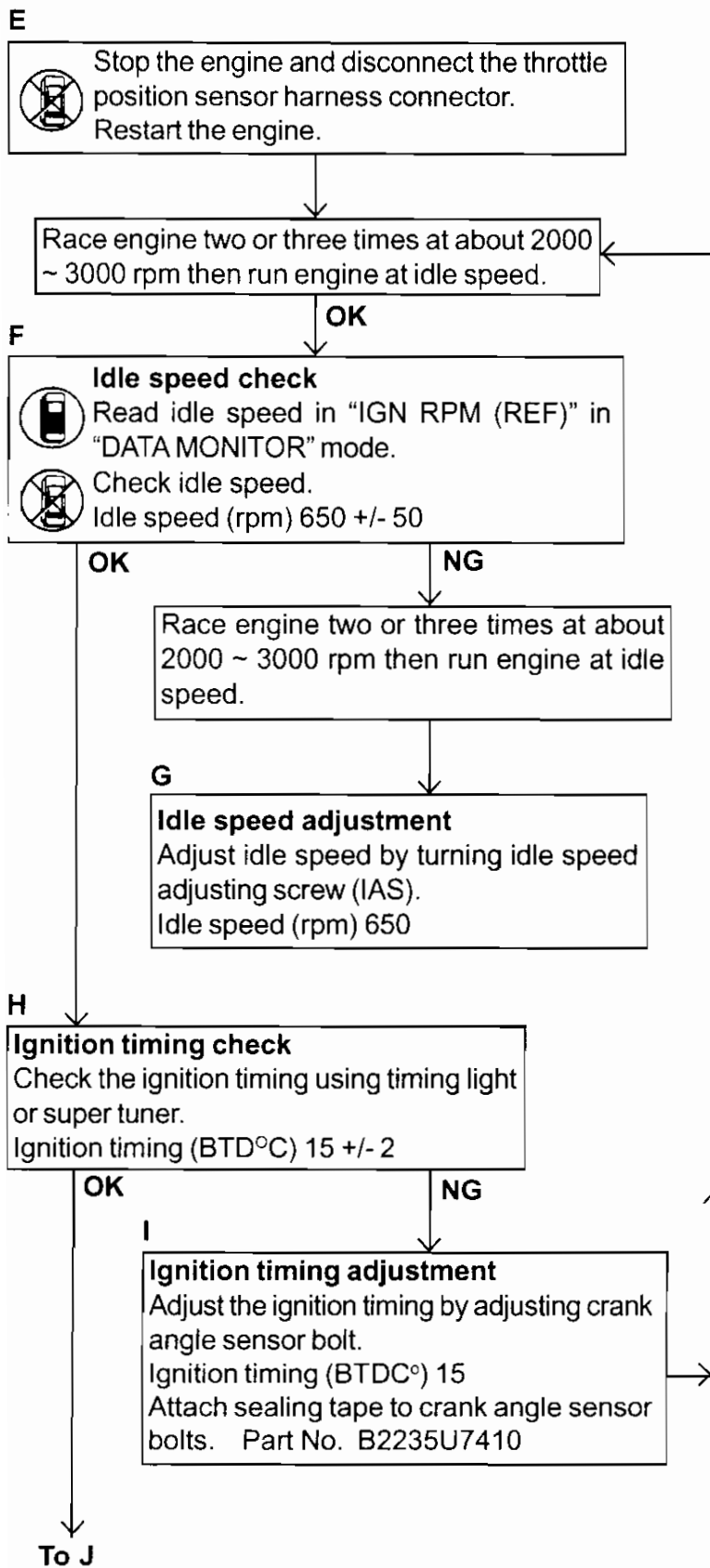

IDLE SPEED / IGNITION TIMING / IDLE MIXTURE RATION INSPECTION

RB25DE ENGINE

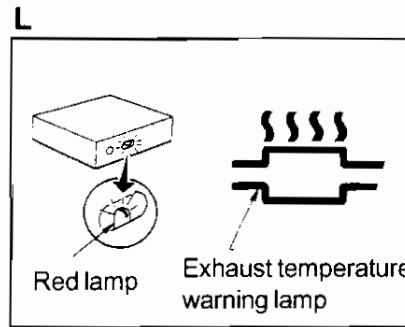
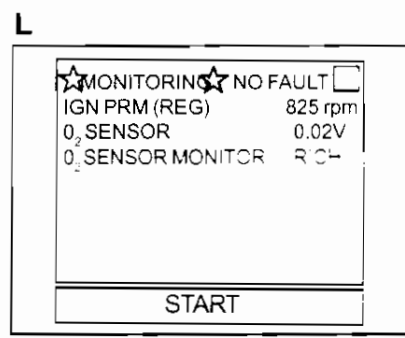
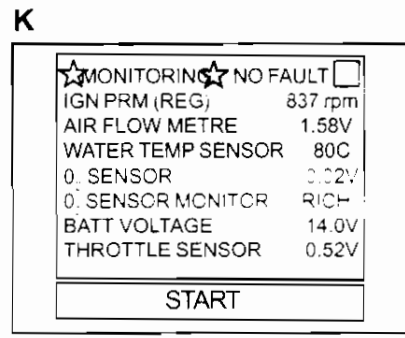
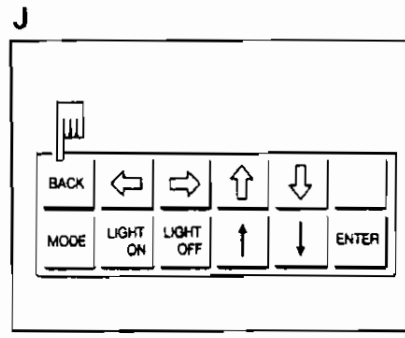
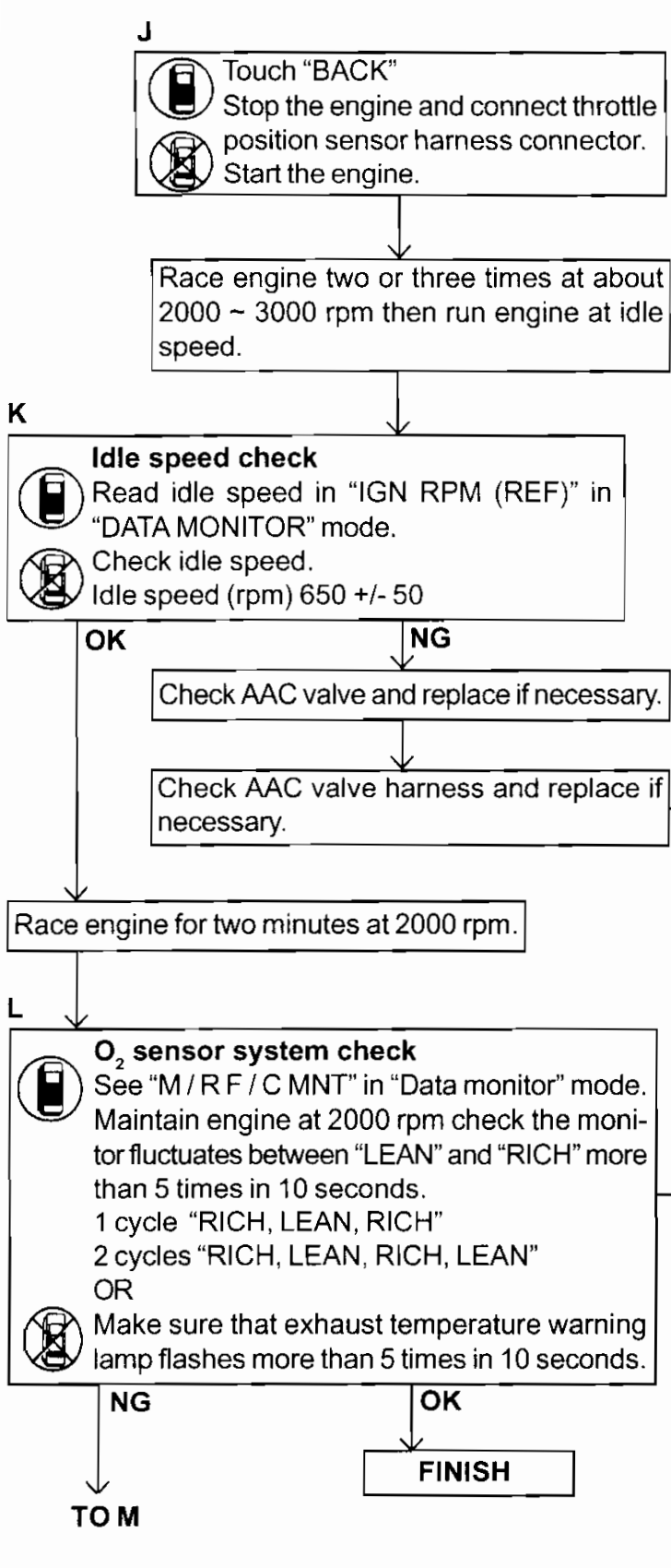

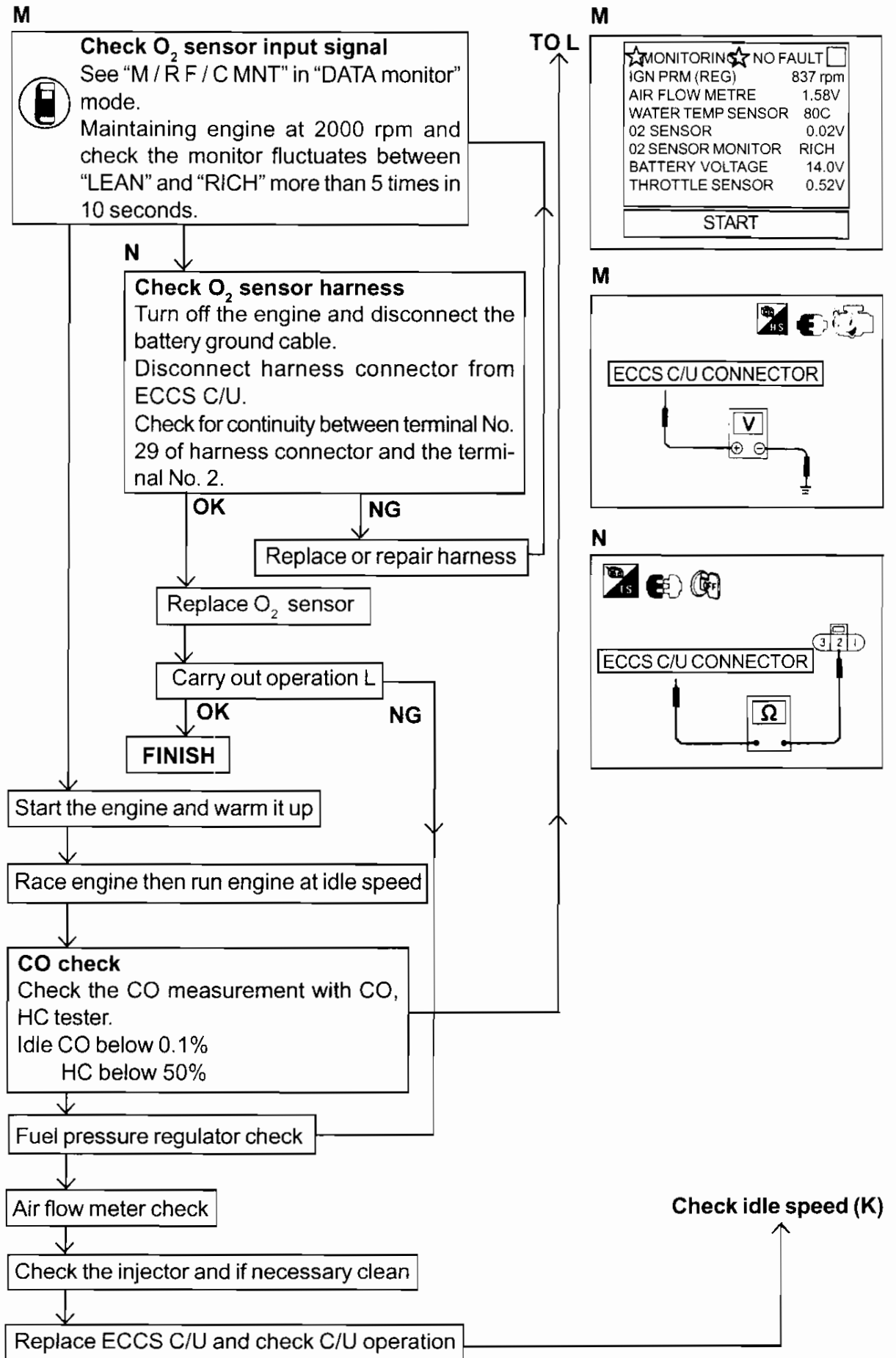

## 2. COMPRESSION PRESSURE INSPECTION

### Compression pressure standard value

Engine	Standard value (kg / cm <sup>2</sup> ) (rpm)	Limit value (kg / cm <sup>2</sup> ) (rpm)	Variance limit between cylinders (kg / cm <sup>2</sup> ) (rpm)
RB26DETT	12.0 / 300	9.0 / 300	1.0 / 300
RB20DE, DET	12.0 / 300	9.0 / 300	1.0 / 300
CA18i	12.2 / 350	10.2 / 350	1.0 / 350
RB20E	12.5 / 300	9.5 / 300	1.0 / 300
RB25DE	12.8 / 300	9.8 / 300	1.0 / 300

### Engine speed measurement unit installation

#### RB26DETT / RB20DE / DET Engine

- Connect the engine speed measurement unit to the speed detection pin on the harness connected to the ignition coil from the power transistor.
- Always attach the terminal cap with rubber seal after measurement is completed.

RB26DETT

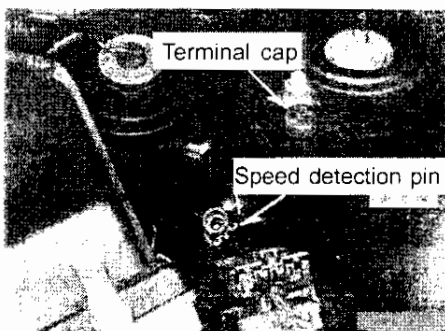

RB20DE / DET

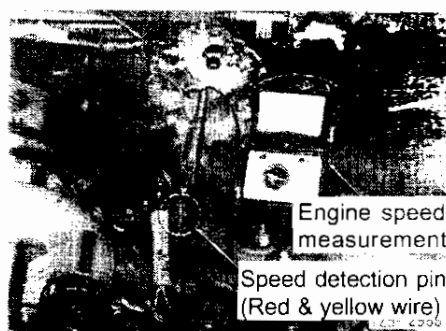

#### CA18i / RB20E Engine

- Mold type ignition coil is used for these engines. Connect the engine speed measurement unit by connecting the adapter for mold coil between the INT side coil primary terminal and the harness connector primary terminal.

RB20E

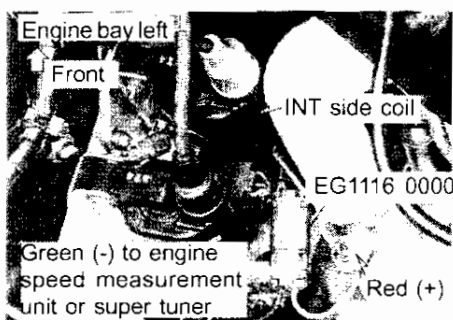

CA18i

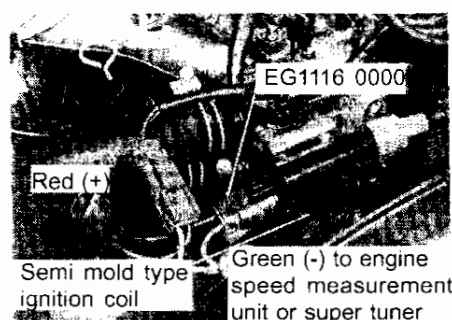

### Compression gauge installation

- Warm up the engine and remove all 6 spark plugs.
- Attach the adapter to the Allen compression gauge and set it in a spark plug hole.

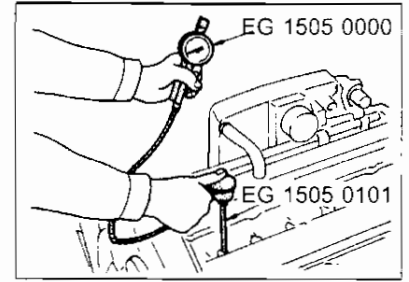

### Compression pressure inspection

- Depress the acceleration pedal fully. Turn the ignition switch to START position and crank the engine. Read compression pressure and the engine speed once the gauge needle stops moving.
- When engine speed is out of specifications, check the specific gravity of the battery and perform test again if the battery is functioning properly.
- If the compression pressure is still not standard, inspect the components around the combustion chamber (valves, valve seat, hydraulic valve lifters, piston rings, cylinder bore, cylinder head, cylinder head gasket etc.). Correct any malfunctions and repeat compression test.

## 3. BELT TENSION INSPECTION AND ADJUSTMENT

### Inspection

The inspection should be performed when the engine cold or more than thirty minutes after the engine has been stopped.

### RB26DETT / RB20DE, DET / RB25DE ENGINE

PART	ITEM	Belt specification	Belt deflection (mm) (When 10kg of force is applied at the "▼" position)		
			New	Adjustment	Tension limit
Power steering belt	Standard	Poly-V low-maintenance belt	8 ~ 10	9 ~ 10	15
	With HICAS		8 ~ 10	10 ~ 12	16
Air conditioner compressor belt		Poly-V low-maintenance belt	6 ~ 8	7 ~ 9	12
Fan belt		Poly-V low-maintenance belt	3 ~ 5	4 ~ 6	7.5

## BELT TENSION INSPECTION & ADJUSTMENT

RB26DETT / RB20E / DE / DET / CA18i / RB25DE ENGINE

### RB20E ENGINE

PART \ ITEM	Belt specification	Belt deflection (mm) (When 10kg of force is applied at the "▼" position)		
		New	Adjustment	Tension limit
Power steering belt	Poly-V low-maintenance belt	8 ~ 10	9 ~ 11	15
Air conditioner compressor belt	Poly-V low-maintenance belt	6 ~ 8	7 ~ 9	12
Fan belt	Poly-V low-maintenance belt	3 ~ 5	4 ~ 6	7.5

### CA18i ENGINE

PART \ ITEM	Belt specification	Belt deflection (mm) (When 10kg of force is applied at the "▼" position)		
		New	Adjustment	Tension limit
Power steering pump belt	Poly-V low-maintenance belt	9 ~ 11	10 ~ 12	15
Air conditioner compressor belt	Poly-V low-maintenance belt	6 ~ 8	7 ~ 9	12
Fan belt	Poly-V low-maintenance belt	4 ~ 5	4.5 ~ 5.5	6

#### Caution:

1. When the belt is replaced with a new belt increase the tension slightly more than for the used belt to allow for wear-in of the new belt.
2. When the belt deflection exceeds the limit, adjust to the "Adjustment" value.
3. Make sure the pulley groove is aligned correctly when the belt is installed.

#### Adjustment

PART \ ITEM	ADJUSTMENT POSITION
Power steering belt	Adjustment bolt in power steering pump
Air conditioner compressor belt	Adjustment bolt in idler pulley
Fan belt	Adjustment bolt in alternator

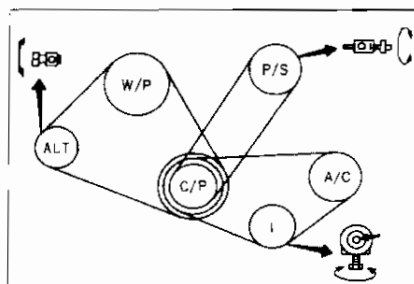
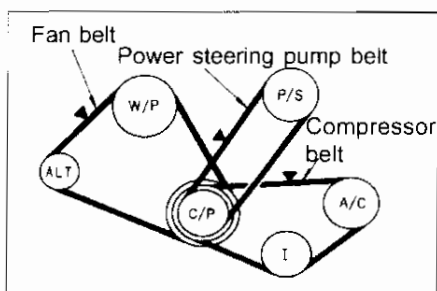

## 4. VALVE CLEARANCE INSPECTION AND ADJUSTMENT

**Additional work required (remove the following parts):**

- Air duct
- Rocker cover

### Inspection

- Inspect the valve clearance when the engine is cold.
- Remove the air duct, ornaments and the rocker cover.
- Rotate the crankshaft and align crankshaft pulley mark with the belt cover indicator.
- No. 1 cylinder is at the compression stroke top dead centre when both the intake and exhaust side cams do not move the valve lifters.

ITEM	PART	VALVE CLEARANCE MEASUREMENT
INTAKE SIDE		Cylinder No. 1, 2, 4
EXHAUST SIDE		Cylinder No. 1, 3, 5

Firing order: 1 - 5 - 3 - 6 - 2 - 4

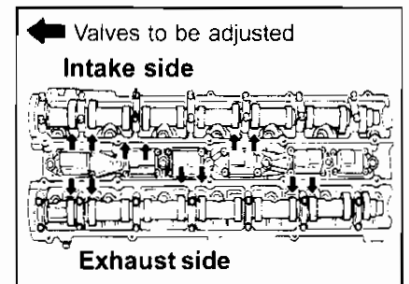

- Rotate the crankshaft one revolution (360°) and align the mark on the crankshaft pulley with the belt cover indicator. (No. 1 cylinder piston exhaust T.D.C).

ITEM	PART	VALVE CLEARANCE MEASUREMENT
INTAKE SIDE		Cylinder No. 3, 5, 6
EXHAUST SIDE		Cylinder No. 2, 4, 6

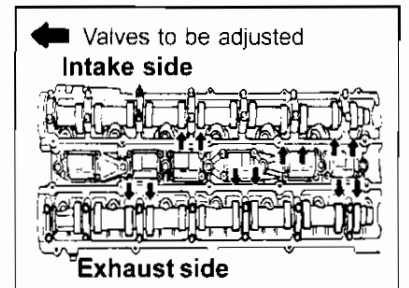

### Valve clearance standard value

(20+/-5°C)

ITEM	PART	INTAKE	EXHAUST
Valve clearance (cold)	mm	0.45 <sup>+0.03</sup>	0.38 <sup>+0.03</sup>
(Reference value: warm)	mm	0.51 <sup>+0.03</sup>	0.44 <sup>+0.03</sup>

### Caution:

Always check the valves when they are cold.

## VALVE CLEARANCE INSPECTION & ADJUSTMENT

RB26DETT / RB20E / DE / DET / CA18i / RB25DE ENGINE

### Valve clearance measurement

- Insert a 0.15 ~ 0.20 mm gauge (A) from spark plug side. Insert gauge (B) from opposite side. Select a gauge thickness that will reduce the clearance to 0 m.

#### Note:

Do not use more than two gauges (B).

Use JIS 150A25 feeler gauge.

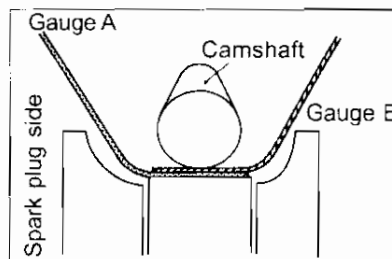

Valve clearance = Gauge (A) + Gauge (B)

Reasons for measurement using gauge (A) and (B) :

1. The valve clearance setting is larger compared to previous engines.
  2. Large gauges cannot be placed parallel to the measurement surface.
- Thick feeler gauge have high rigidity and cannot be bent easily, so the measurement will be incorrect.
  - The error factor increases if a number of thin gauges are layered and the measurement will be incorrect.

### Valve clearance adjustment

- The valve clearance adjustment is performed by selecting a shim of suitable thickness.
- When the measurement valve clearance (t) is out of specification, measure the shim thickness (T) and replace it with a shim that will produce the standard clearance.

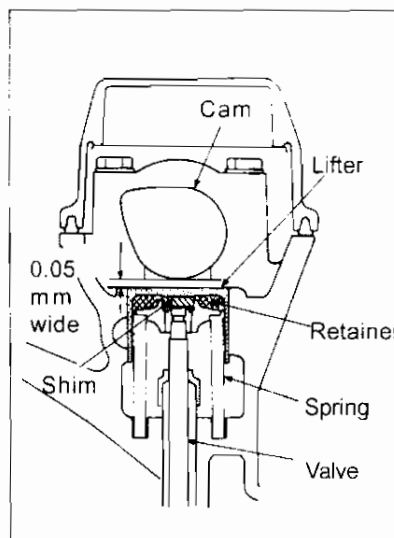

#### 1. Shim thickness calculation method

##### Example:

When the intake valve clearance (t) is 0.50 mm:

$$0.50 (t) - 0.45 (\text{specified value}) = 0.05 \text{ mm}$$

- The valve clearance is 0.05 mm greater than the specified value.
- Use a shim 0.05 mm thicker than the current shim to reduce the valve clearance.

#### 2. Current shim thickness (T)

- Measure the centre of removed shim to determine the thickness of the current shim.

##### Caution:

Do not reuse the measured shims again.

#### 3. Shim selection

- Current shim thickness (T) is 2.40 mm.  
 $2.40 (T) \text{ mm} + 0.05 \text{ mm} = 2.450$
- Select new shim with stamped mark [24.40] (T = 2.440 ~ 2.455).
- Select a shim within standard value range +/- 0.03 mm.

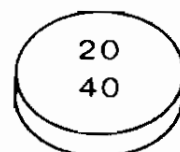
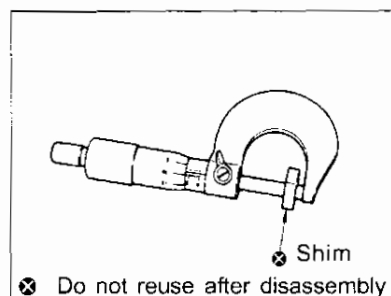

T = 2.440 ~ 2.455 mm

#### 4. Shim types and classification

- There are 70 types of shims. Sizes range from 2.275 mm to 3.325 mm in 0.05 mm increments.



## 5. LUBRICATION SYSTEM INSPECTION

### 5-1 LUBRICATION OIL LEVEL INSPECTION

#### Inspection

- The engine oil level should be checked before starting the engine or if the engine has been started, the inspection must be carried out ten minutes after the engine has been turned off.
- The oil level should be between the H and L lines on the level gauge.
- The oil must not have any white turbidity or dirt.

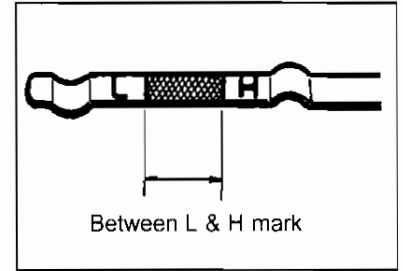

#### Lubrication oil replacement period

ENGINE	REPLACEMENT PERIOD	OIL USED
RB20DET / RB26DETT	Every 5,000km or 6 months	SD, SE, SG, SF class oil
CA18i / RB20E	Every 15,000km or 12 months	SE, SF, SG class oil
	Every 10,000km or 6 months	SD class oil
RB20DE / RB25DE	Every 15,000km or 12 months	SE, SF, SG class oil
	Every 10,000km or 6 months	SD class oil

#### Note:

Use genuine Nissan [Turbo X (7.5W ~ 30)] for service for RB26DETT / RB20DET vehicles.  
Use genuine Nissan SG class [Extra save X (7.5 ~ 30)] for service for CA18i / RB20E, DE / RB25DE vehicles.

#### Oil quantity

ENGINE	ITEM	Oil level (L)		Oil supplement volume when replaced (L)	
		H	L	Only oil replacement	Oil and oil filter replacement
RB25DE / RB20DE / RB20E		4.0	3.0	Approx. 3.8	Approx. 4.2
RB20DET / RB26DETT / 4WD		4.5	3.5	Approx. 4.2	Approx. 4.6
CA18i		3.4	2.4	Approx. 3.2	Approx. 3.6

**5-2 OIL PRESSURE INSPECTION**

- Remove the oil pressure switch and connect the oil pressure gauge.
- After warming the engine, make sure the oil pressure is appropriate to the engine speed.

(Oil temperature 80°C)

ENGINE	RB26DETT	RB20E, DE, DET/ RB25DE	CA18i
<b>Engine speed (rpm)</b>	<b>Outlet pressure (kg / cm<sup>2</sup>)</b>		
<b>600</b>	-	Approx. 1	Approx. 1
<b>800</b>	Approx. 1.5	-	-
<b>2000</b>	Approx. 3	Approx. 3	Approx. 3
<b>4000</b>	-	-	Approx. 4
<b>6000</b>	Approx. 4.6	Approx. 4	-

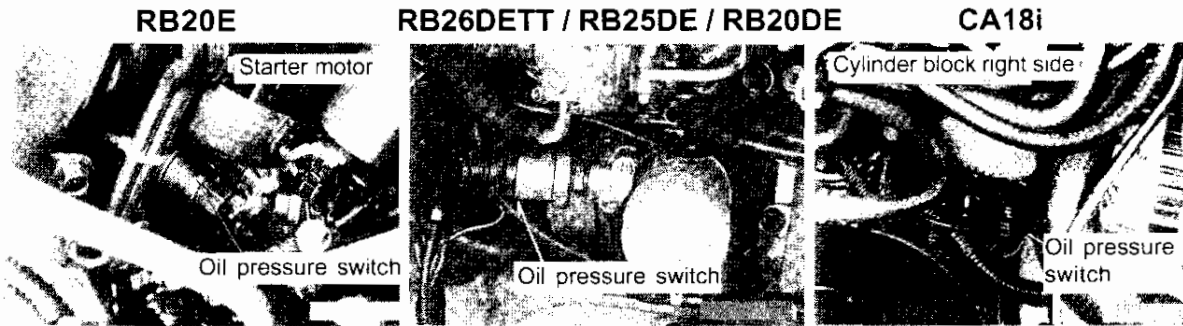

**5-3 OIL FILTER REPLACEMENT**

**Removal**

- Use oil filter wrench (special service tool) to remove the filter.

Caution:

Catch any dripping oil with rag etc. when removing the filter.

**Installation**

- Before installing the new oil filter, clean the oil filter bracket mounting surface on the cylinder block and coat the oil filter seal lips lightly with new engine oil.
- Screw in the oil filter until a slight resistance is felt and then tighten 2/3 turn.

Caution:

Make sure the oil will not leak after starting the engine.

ENGINE	REPLACEMENT PERIOD	OIL USED
RB20DET / RB26DETT	Every 10,000km or 12 months	SD, SE, SG, SF class oil
CA18i / RB20E	Every 15,000km or 12 months	SE, SF, SG class oil
	Every 10,000km or 12 months	SD class oil
RB20DE / RB25DE	Every 15,000km or 12 months	SE, SF, SG class oil
	Every 10,000km or 12 months	SD class oil



## 6. EXHAUST SYSTEM INSPECTION

### 6-1 AIR CLEANER ELEMENT INSPECTION (RB26DETT / RB20E / DE / DET)

#### Inspection

- Remove the bands shown in the diagram and remove the air cleaner element.
- There should be no excessive dirt or damage on the air cleaner element.

Periodic replacement interval

Every 60,000 km



### 6-2 TURBOCHARGER INSPECTION (RB26DETT / RB20DET)

#### Function inspection

- Remove the intake manifold canister hose, and place a cap on the hose. Connect test hose to intake manifold and attach pressure gauge (compound gauge).
- Perform the engine operation test and check that pressure does not rise above approximately 0.8 ~ 0.9 kg / cm<sup>2</sup>.
  - When the pressure does not reach specified level.
    - Check for vacuum leak in intake or exhaust system or exhaust gas leak.
  - When the pressure exceeds the maximum pressure level (approx. 0.8 ~ 0.9 kg / cm<sup>2</sup>).
    - Check if swing valve controller rubber hose is disconnected or cut.
    - Check if swing valve controller motion malfunctions (stays closed).

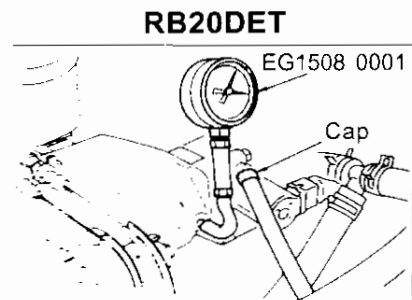
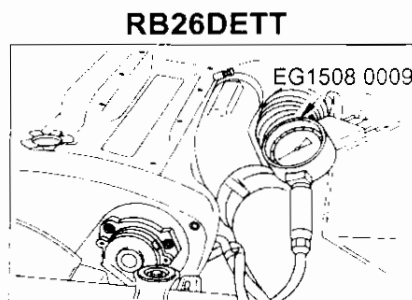

**Swing valve controller inspection**

- Remove the swing valve controller rubber hose from the vacuum tube side.
- The controller rod must start operating when compressed air approx.  $0.7 \sim 0.8 \text{ kg / cm}^2$  (RB26DETT), approx.  $0.8 \sim 0.9 \text{ kg / cm}^2$  (RB20DET) is forced into the hose by using an air gun. Stop blowing compressed air as soon as control rod operation is verified.

**Caution:**

The diaphragm may be damaged if excessive air pressure is applied. Use the LPG pressure gauge (special service tool for  $1 \text{ kg / cm}^2$ ) to verify that the air gun pressure is approx.  $0.7 \sim 0.8 \text{ kg / cm}^2$  (RB26DETT) or  $0.8 \sim 0.9 \text{ kg / cm}^2$  (RB20DET) before testing the air hose.

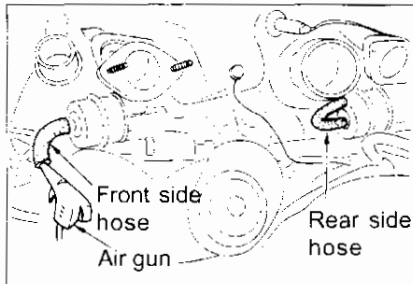
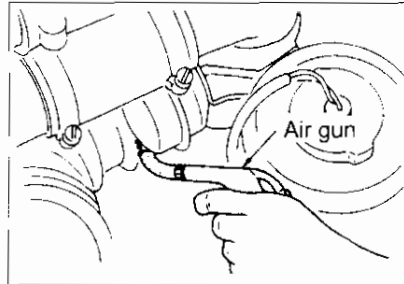
**RB26DETT****RB20DET****6-3 RECIRCULATION VALVE INSPECTION****Function inspection**

- Remove the hose on upper flow side of the recirculation valve compressor (place the cap on end of the hose) and check if air blows back when throttle is closed quickly.

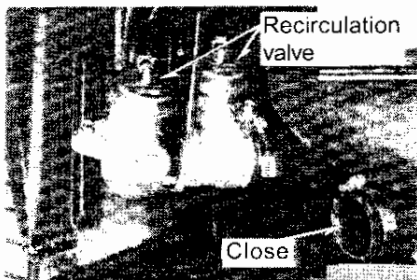
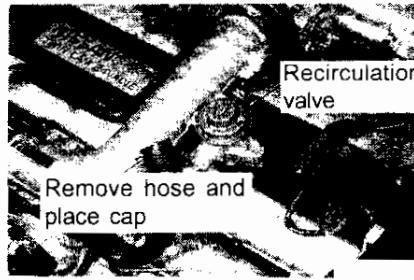
**RB26DETT****RB20DET****Unit inspection**

- Use a hand pump to create negative pressure  $-150 \pm 30 \text{ mmHg}$  (RB26DETT)  $-400 \pm 50 \text{ mmHg}$  (RB20DET). The recirculation valve diaphragm must start to lift up and the vacuum pressure will be maintained.

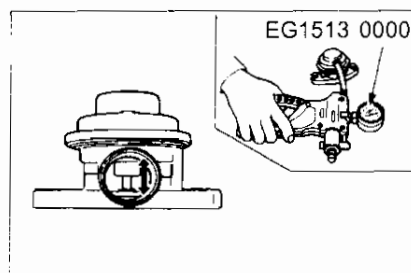

**6-1 AUTOMATIC TEMPERATURE ADJUSTMENT AIR CLEANER INSPECTION**  
**System diagram**

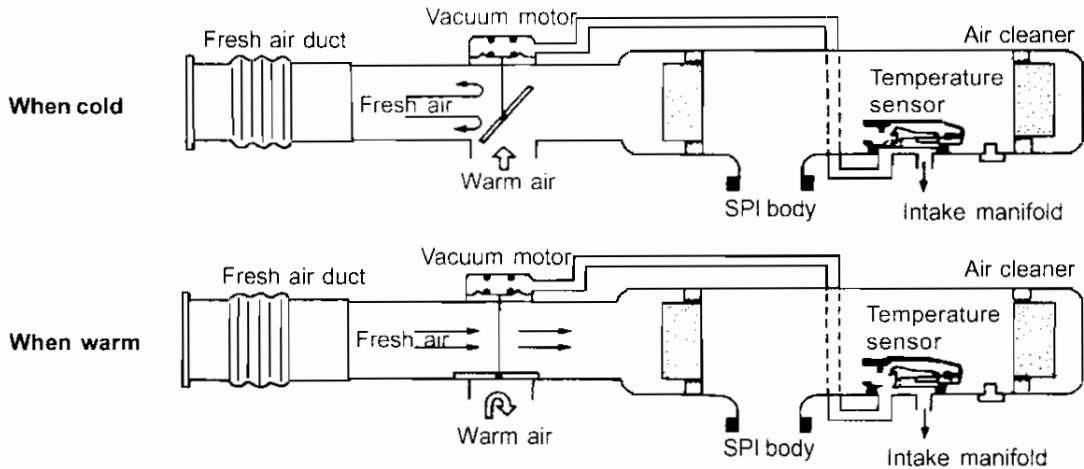

**Function inspection**

- Remove the air duct and start the engine. Inspect the vacuum motor operation when the engine is cold and warm.

Condition	Change-over valve fresh air duct side
When cold	Closed
When warm	Open

Temperature sensor preset temperature: Approx. 40°C.

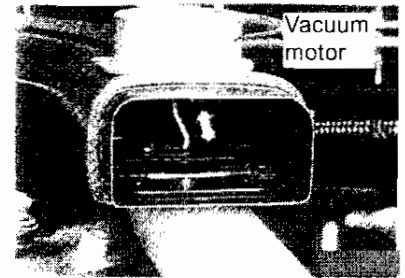

**COMPONENT PARTS INSPECTION**

**Temperature sensor inspection**

- Remove the hose to the vacuum motor and connect the vacuum gauge.
- Start the engine and check the negative pressure when the temperature of the temperature sensor was cooled / warmed by the drier.

When warmed up No negative pressure  
 When cooled Negative pressure created

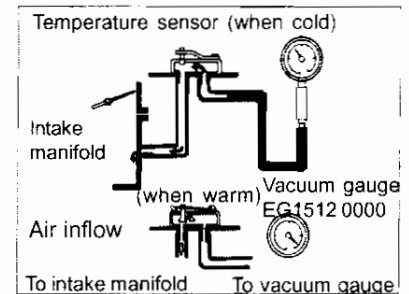

**Vacuum motor inspection**

- Remove the vacuum hose from the vacuum motor and connect vacuum hand pump.
- Use a hand vacuum pump to create negative pressure (approx. -150 mmHg).
- Make sure the fresh air duct on the change-over valve will close when the negative pressure is applied and it will open when there is no negative pressure applied.

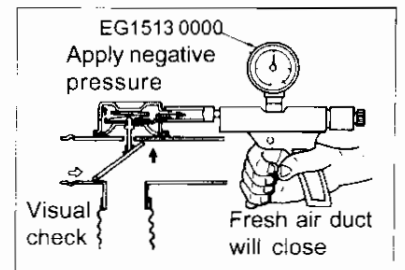

**6-2 AIR CLEANER ELEMENT INSPECTION**

**Inspection**

- Remove the clips and the nuts and remove the air cleaner element.
- There should be no excessive dirt or damage in the air cleaner element.

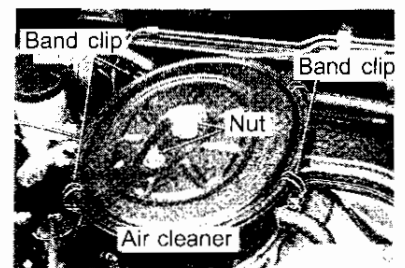

## 7 FUEL SYSTEM INSPECTION

### EASY INSPECTION (RB25DE)

- Turn the ignition switch to ON position.
- Select "Fuel pump" in the "Function test" mode.
- Inspect the pulsation by holding the fuel hose with hand.



◆ FUEL PUMP ◆

IS THERE A PULSATION EVERY 3 SECONDS WHEN THE FUEL TUBE IS HELD? OR CAN YOU HEAR THE OPERATION NOISE OF THE FUEL PUMP RELAY?

PASS NO YES

- Hold the fuel filter and make sure the hose is hard and pulsation can be felt when the fuel pump is operating.

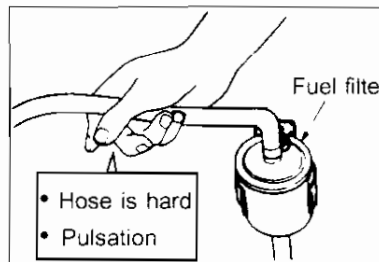

### FUEL PRESSURE INSPECTION USING THE FUEL PRESSURE METER

#### Releasing fuel pressure (RB25DE)

- Rev the engine.
- Select "Fuel pump relay" in "Active test" mode.
- Press 'STOP' to stop the engine. Crank the engine over two or three times. (If the engine does not start crank 3 ~ 4 times after removing the fuse).



- Restart the engine and remove the fuel pump fuse.
- After the engine stops, crank the engine 4 ~ 5 times to consume the fuel in the pipe. (If the engine does not start crank 4 ~ 5 times after removing the fuse).



**Caution:**

The battery may become weak easily, use booster cable to connect to another battery if necessary.

◆ ACTIVE TEST ◆

FUEL PUMP RELAY OFF

CAS-RPM (POS) 950 rpm

OPERATE INTERRUPT STOP

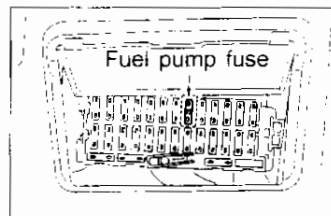

#### Releasing fuel pressure (CA18i / RB20E)

- Rev the engine.
- Select "Release fuel pressure" in "Operation support" mode.



◆ FUEL PRESSURE ◆

WHILE IDLING PRESS "START" TO STOP THE FUEL PUMP OPERATION. AFTER ENGINE STOPS, CRANK THE ENGINE OVER TWO OR THREE TIMES.

START

- After starting the engine, remove the fuel pump fuse. After the engine stops, crank the engine over 2 ~ 3 times to consume the fuel in the pipe. (If the engine does not start crank 3 ~ 4 times after removing the fuse).



**Caution:**

The battery may become weak easily, use booster cable to connect to another battery if necessary.

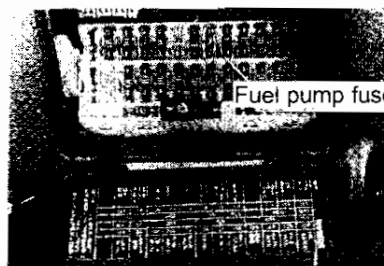

**7-1 FUEL PRESSURE INSPECTION**

**Releasing fuel pressure (RB20DE / DET / RB26DETT)**

- After starting the engine, remove the fuel pump fuse. After the engine stops, crank the engine over 2 ~ 3 times to consume the fuel in the pipe.
- If the engine does not start, remove the pump fuse and crank the engine 3 ~ 4 times to consume the fuel in the pipe.

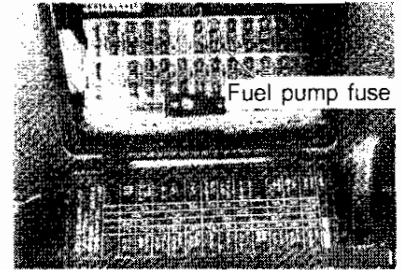

**Caution:**

The battery may become weak easily, so use booster cables to connect it to another battery if necessary.

**Fuel pressure meter installation**

**(RB26DETT / RB20E / DE / DET / CA18i / RB25DE)**

- Connect the fuel pressure meter between the fuel filter and the fuel line.
- Attach the fuel pump fuse.

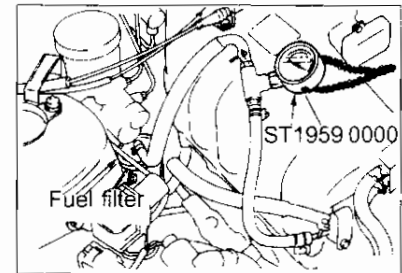

**Fuel pressure inspection**

- Start the engine and check if the fuel pressure is at standard value.
- If the engine does not start, check fuel pressure after 5 seconds when the ignition switch has been turned ON.

**Fuel pressure measurement**

ITEM	ENGINE	RB20DE, DET / RB26DETT	RB20E	RB25DE	CA18i
When ignition switch is ON (kg/cm <sup>2</sup> )		Approx. 3.0	Approx. 2.5	Approx. 3.0	-
During idling (kg/cm <sup>2</sup> )		Approx. 2.5	Approx. 2.0	Approx. 2.55	Approx. 1.0
Idling when pressure regulator vacuum hose is removed (kg/cm <sup>2</sup> )		Approx. 3.0	Approx. 2.5	Approx. 3.0	Approx. 1.0

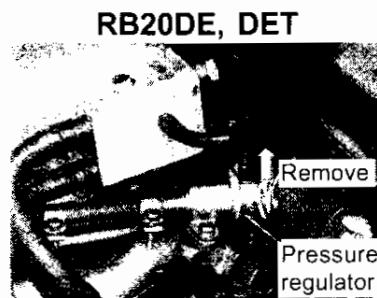
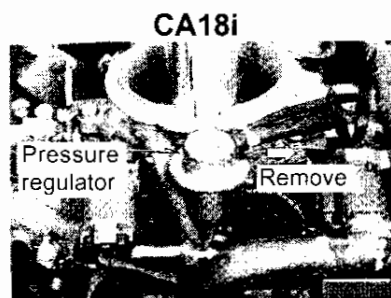

**7-2 THERMO-WAX INSPECTION (CA18i)**

- Inspect the wax stroke when in following temperature.

Temperature ( °C)	25	80
Wax stroke S (mm)	Approx. 25	Approx. 30

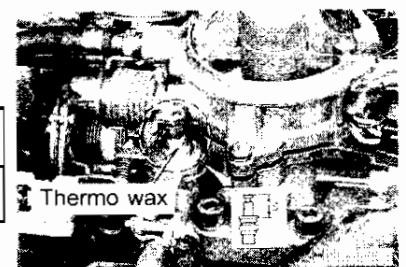

## 8 EVAPORATIVE GAS CONTROL SYSTEM INSPECTION

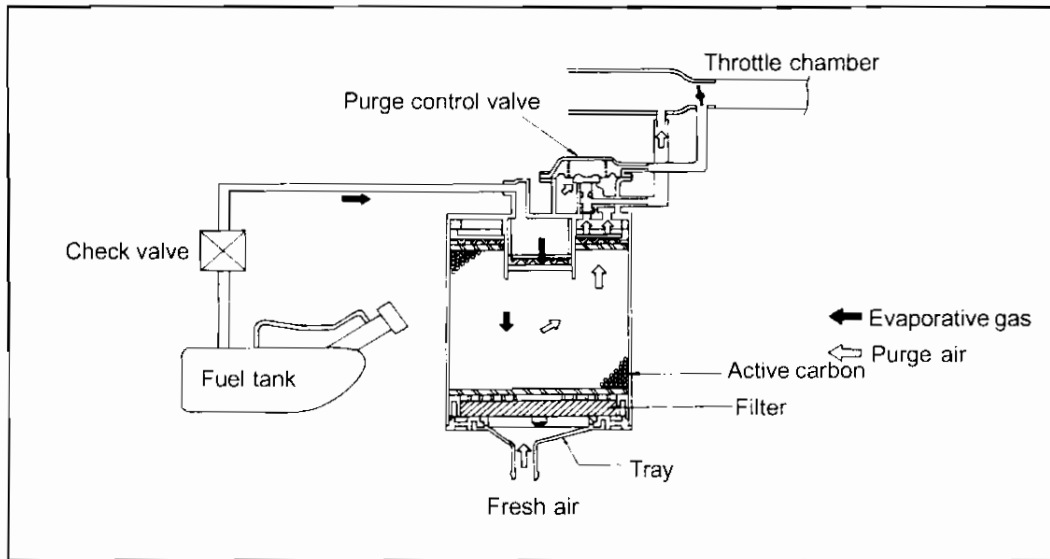

### 8-1 PURGE CONTROL VALVE INSPECTION CANISTER

#### Inspection

- Use vacuum hand pump to apply approximately -400 mmHg (-100 mmHg RB25DE engine) negative pressure and make sure the vacuum pressure is maintained.
- In that condition, check that small amount of air can be sucked from the manifold vacuum path.

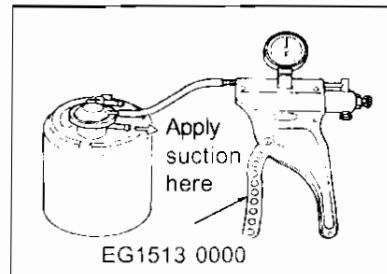

### FUEL TANK VACUUM RELEAF VALVE (RB25DE)

#### Inspection

- Clean the valve housing.
- If the fuel tank vacuum releaf valve is normal, you will hear sound from the valve with small resistance when the air is sucked in through the cap.
- Replace the cap ASSY if the valve is closed or no resistance is felt.

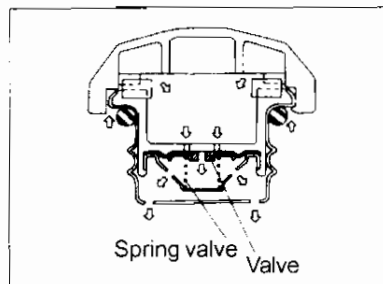



## 9 BLOWBY GAS REDUCTION DEVICE INSPECTION

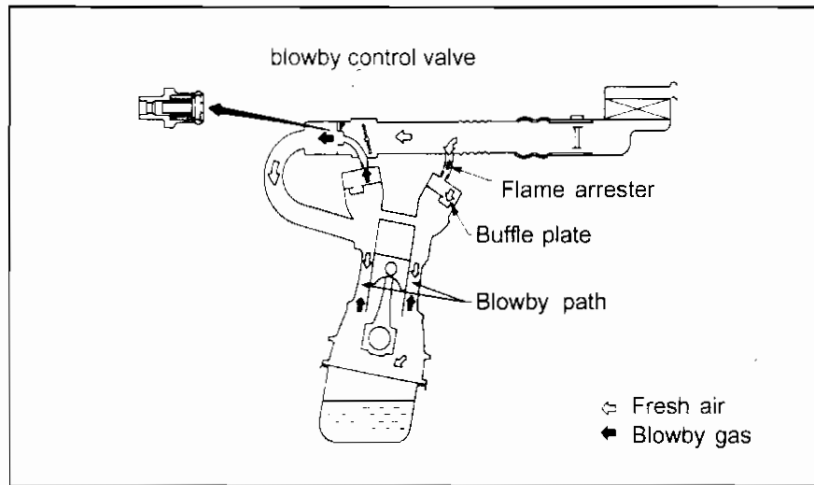

### 9-1 BLOWBY CONTROL VALVE INSPECTION (EXCL CA18i)

#### Inspection

- Check the blowby control valve flow path.

	CONDITION
Air is blown	Air passes
Air is drawn in	No air passes

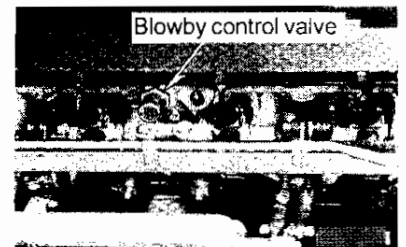
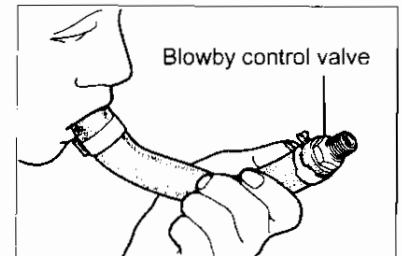

#### Inspection (CA18i)

- Remove the air cleaner rocker cover hose when the engine rev is approximately 1000 rpm and check that fresh air is drawn in.



**10 REMOVAL AND INSTALLATION OF ON-VEHICLE PARTS**  
**10-1 INTERCOOLER AIR DUCT ASSEMBLY**

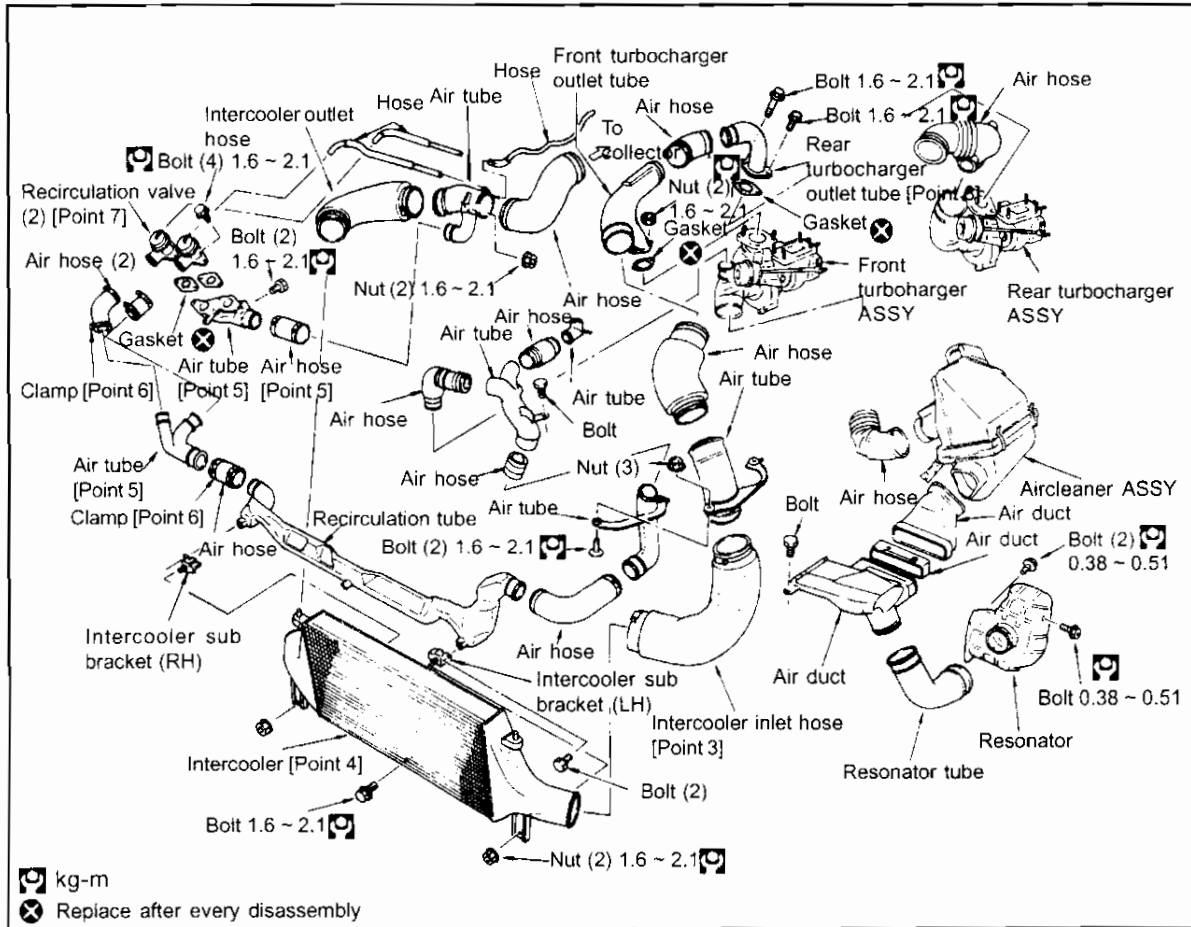

**Additional work required:**

- Undercover
- Front bumper

**[Point 1] Cleaning air hoses & air duct**

- Use air gun to remove any dust and rubbish before removing each air hoses and air ducts.

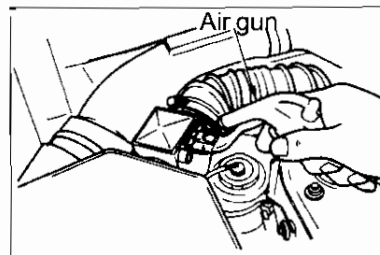

**[Point 2] Remove & install each air hoses and tubes**

**Removal**

- Place alignment mark on each air hose and tubes before removal.

**Installation**

- Align the alignment marks when installation and make sure to tighten the clamp securely.

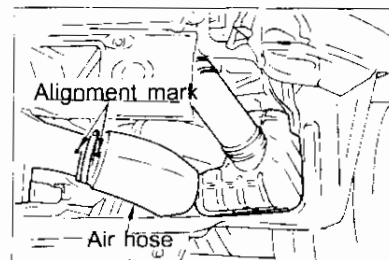

**[Point 3] Remove and install the intercooler inlet hose**

**Removal**

- First remove the resonator and the tube B before removing hose A.

**Installation**

- Attach hose A, then attach resonator and the tube B as a single unit to install.

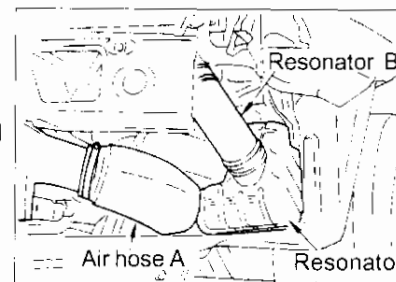

**[Point 4] Remove and install intercooler**

**Removal**

1. Remove the bumper finisher and the bumper reinforcement.
2. Separate the intercooler inlet and outlet hoses.
3. Remove the mounting bolt and two nuts. Detach intercooler without scratching the fins.

**Caution:**

1. An aluminium fins are used and can be damaged easily. Do not place objects on the intercooler or allow tools or other hard objects to contact the fins.
2. The main unit (tank, fin tube) cannot be disassembled.

**Installation**

- Installation operation is the reverse of the removal operation. Perform the steps in order of 3, 2, 1.

**Tightening torque (kg-m): 0.93 ~ 1.2**

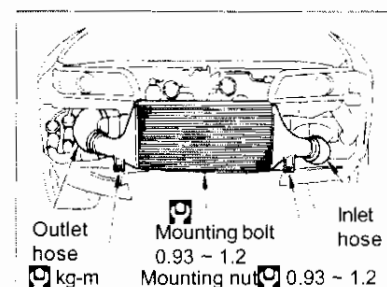

**[Point 5] Remove and install recirculation hose**

- Remove and install the recirculation hose and tube as shown in the figure on right.

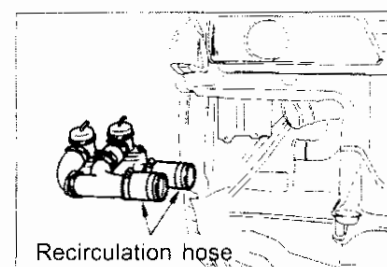

**[Point 6] Install recirculation hose clamp**

- When installing the recirculation hose clamp, make sure it will not contact bumper finisher.

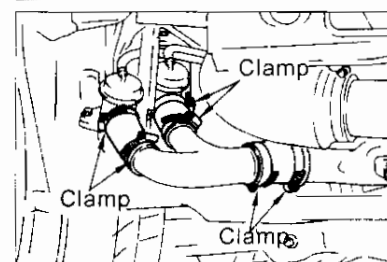

**[Point 7] Recirculation valve inspection**

**Unit inspection**

- Use hand vacuum pump to apply negative vacuum of -150 +/- 20 mmHg and check that recirculation valve diaphragm lifts and vacuum pressure is maintained.

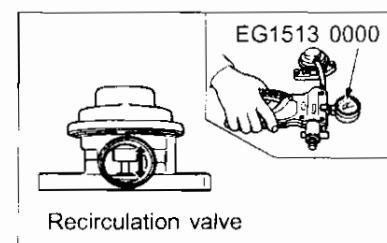

**[Point 8] Remove and install turbocharger outlet tube**

- Remove and install the turbocharger outlet tube as shown in the figure on right.

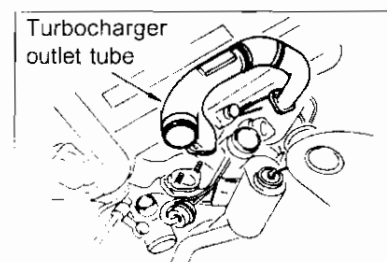

10-2 AIR CLEANER ELEMENT ASSEMBLY

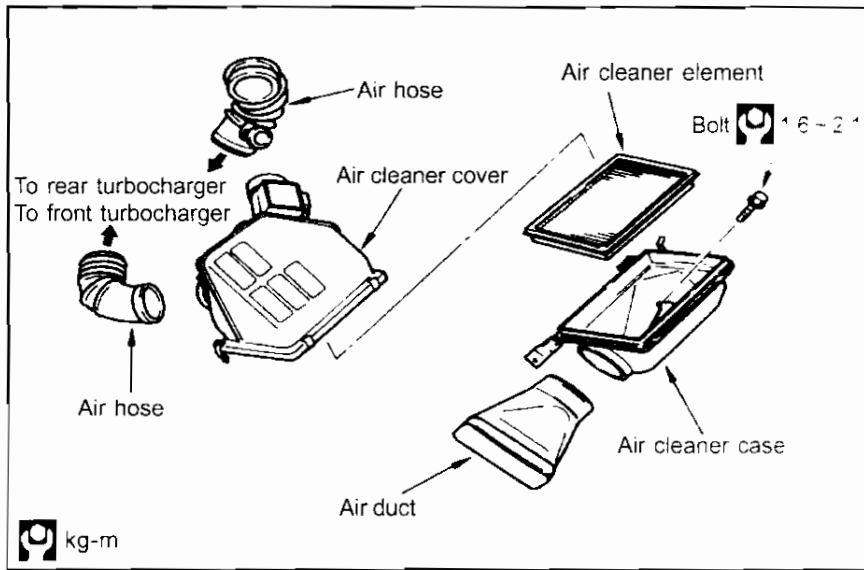

**Additional work required:**

- Remove turbocharger outlet hose

**[Point 1] Air hose and air duct cleaning**

- Use an air gun to blow off any dirt and dust before removing the air cleaner element.

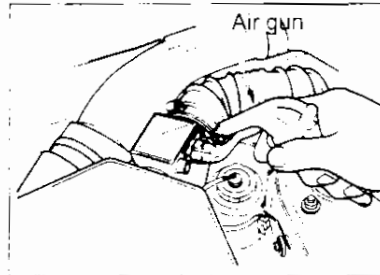

**[Point 2] Remove and install air cleaner element**

**Removal**

1. Remove turbocharger outlet hose.
2. Remove four band clips from the air cleaner. Lift air cleaner cover and remove the air cleaner element.

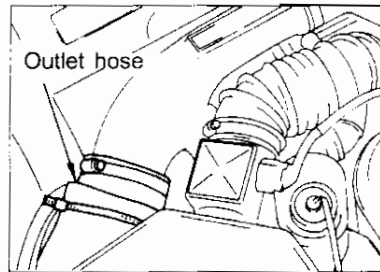

**Installation**

- Install in reverse order of removal.

**[Point 3]**

- Make sure the air cleaner element is not dirty or damaged.

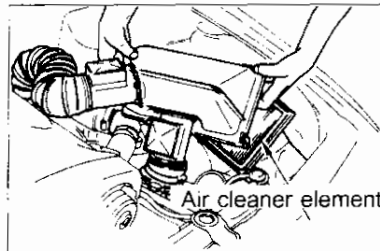

**Periodic replacement interval: Every 60,000 km**

**[Point 4]**

- First connect the air flow meter connector for front turbo charger and then install the air cleaner cover.

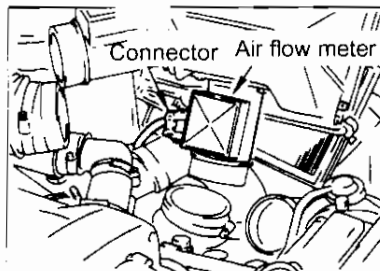

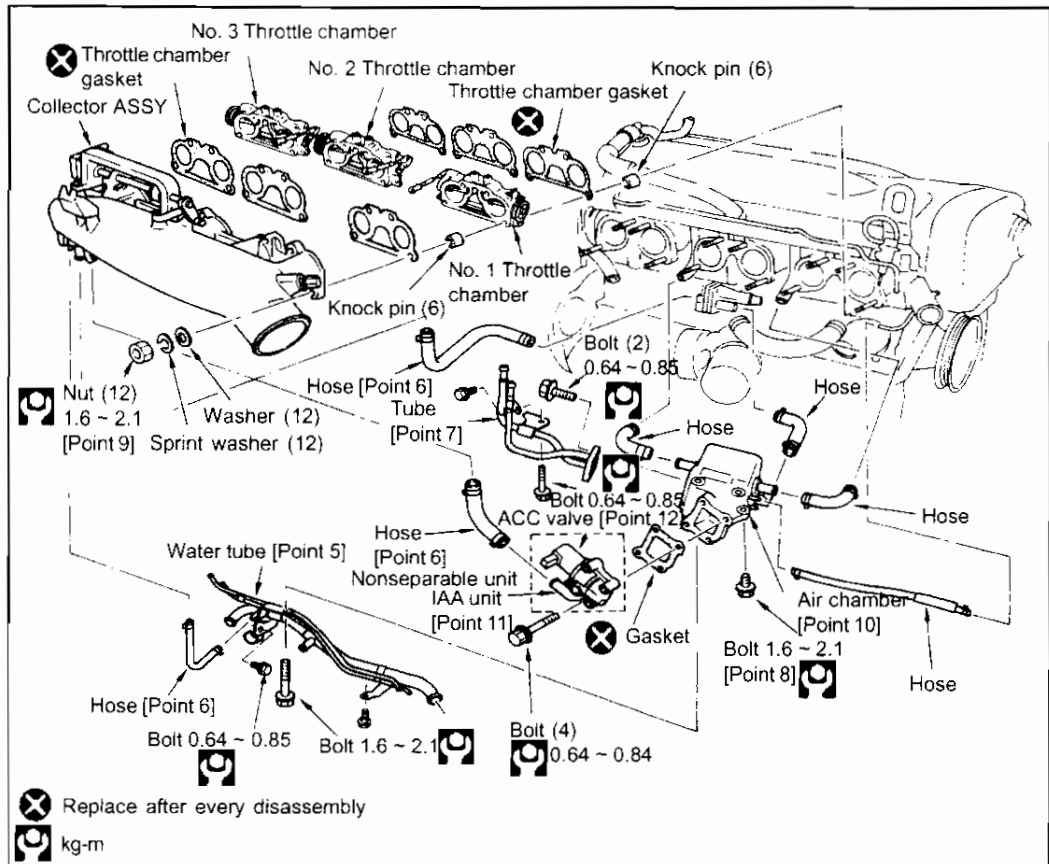
**10-3 CONNECTOR ASSY****(1) Collector ASSY removal and installation****Additional work required:**

- Release fuel pressure in the fuel lines [Point 1]
- Drain cooling water [Point 2]
- Acceleration control wire [Point 3]
- Air inlet hose
- EGI harness connector, harness clamp
- All hoses

**[Point 1] Release fuel pressure**

- Start the engine
- After starting the engine remove the fuel pump fuse and wait until the engine stops. Crank engine two or three times to consume fuel remaining in the fuel pipes.
- If the vehicle doesn't start, remove the fuel pump fuse and crank the engine four to five times to consume fuel remaining in the fuel pipes.

**Caution:**

The battery may become weak easily, use booster cable to connect to another battery if necessary.

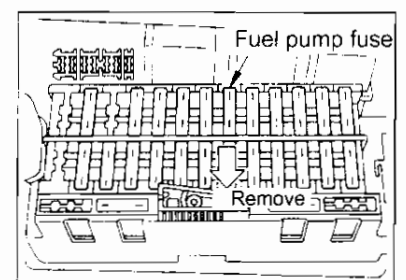

**[Point 2] Draining the cooling water**

- Make sure to drain cooling water completely from the cylinder block by removing the drain plug.

**Caution:**

Make sure the coolant does not spill on the front tube.

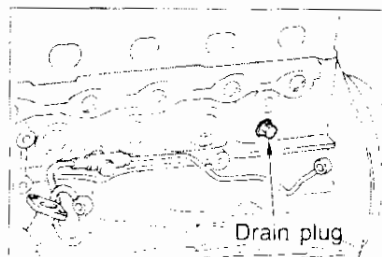
**[Point 3] Accelerator wire adjustment**

- Loosen lock nut to provide adequate slack for the accelerator wire and pull outer case in the direction of the accelerator.
- Return the lock nut 1.0 to 1.5 turns from the position the throttle drum starts moving (when there is no play in cable) and tighten.

**Tightening torque (kg-m): 0.8 ~ 1.0**

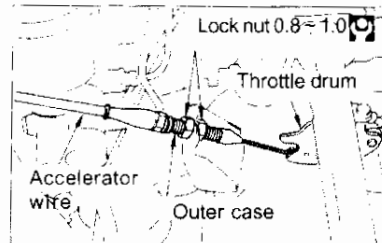
**[Point 4] Remove throttle chamber links**

- Remove the mounting nuts indicated by arrow marks in the diagram. Separate three throttle chamber links from collector side.
- Remove the harness from the throttle sensor and the throttle valve switch.

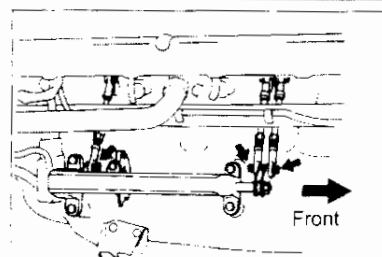
**[Point 5] Fuel pipe removal**

- Remove three bolts indicated by the arrows and separate the fuel pipe.

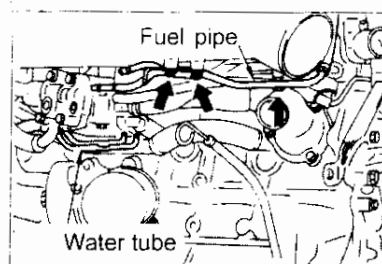
**[Point 6] Air hose removal**

- Separate the air hose A, B and C from the collector side.

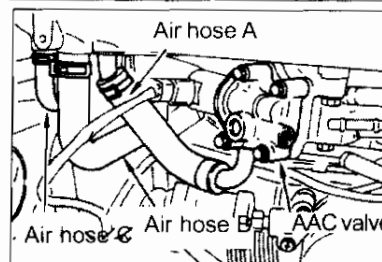
**[Point 7] Booster vacuum removal**

- Remove the clamp bolt and remove the booster vacuum tube by separating it from the collector and the air chamber.

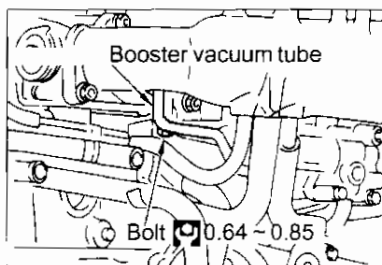
**[Point 8] Remove and install air chamber bolts****Removal**

- Separate the air chamber by removing three bolts.

**Installation**

- Insert bolt B in air chamber bolt hole, before performing final assembly.

**Tightening torque (kg-m): 1.6 - 2.1**

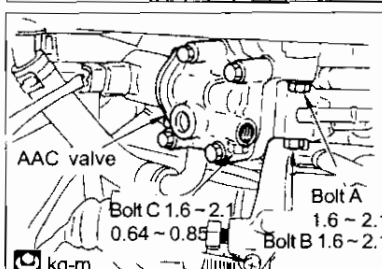

**[Point 9] Remove and install collector nut**

**Removal**

- Remove the nuts in the reverse order of the figure on the right.

**Installation**

- Install the nuts in the order shown in the figure on right uniformly in two to three stages.

**Tightening torque (kg-m): 1.6 ~ 2.1**

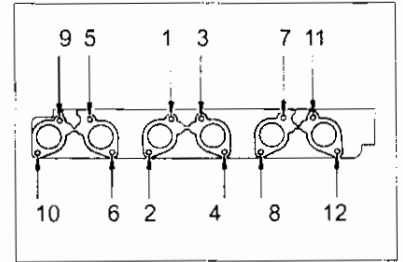

**[Point 10] Remove and install air chamber**

**Remove**

- Separate the air hoses A, B, C, vacuum hoses D, F and AAC valve connector and remove the air chamber.

**Installation**

- Position the air chamber in place, connect the air hoses C, D, A, vacuum hoses F, E, then connect AAC valve.

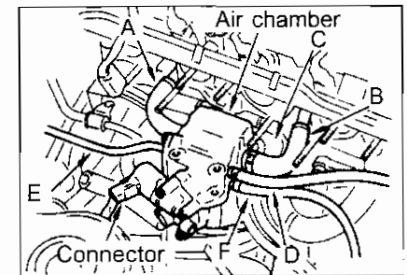

**[Point 11] Remove and install AAC valve**

**Removal**

- Detach the AAC valve by first removing four bolts.

**Caution:**

- AAC valve cannot be disassembled.
- Replace gasket with a new one.

**Installation**

- Install gasket and the AAC valve.

**Tightening torque (kg-m) : 0.64 ~ 0.85**

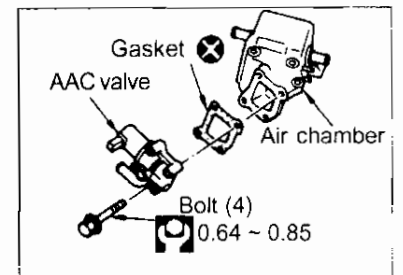

**[Point 12] AAC valve inspection**

- Measure the AAC valve resistance

**Resistance (20°C) Ω Approx. 9 ~ 10**

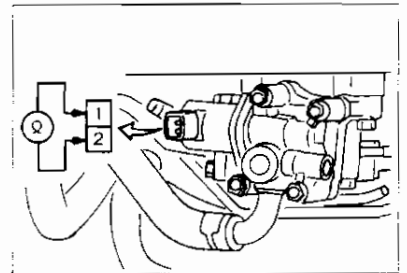

**(2) Collector ASSY disassembly and assembly**

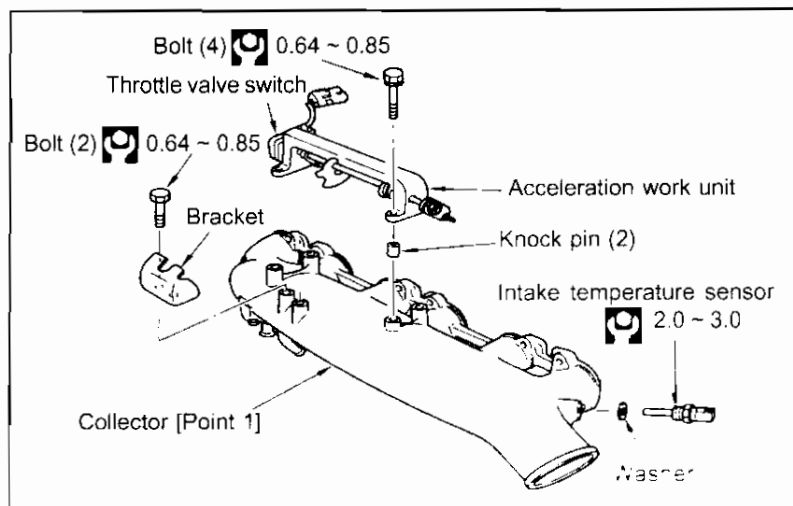

RB26DETT ENGINE

**Additional work required:**

- Collector ASSY installation refer to "Throttle valve switch system inspection" for the throttle valve switch adjustment procedures.

**[Point 1] Collector inspection**

- Measure the collector installation surface for distortion in six directions (opposing directions, up, down, left, right, horizontally and vertically).  
**Limit (mm): 0.15**

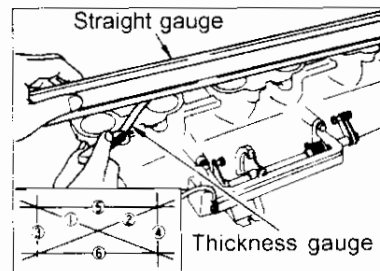

**10-4 SIX IN-LINE THROTTLE CHAMBER REMOVAL AND INSTALLATION**

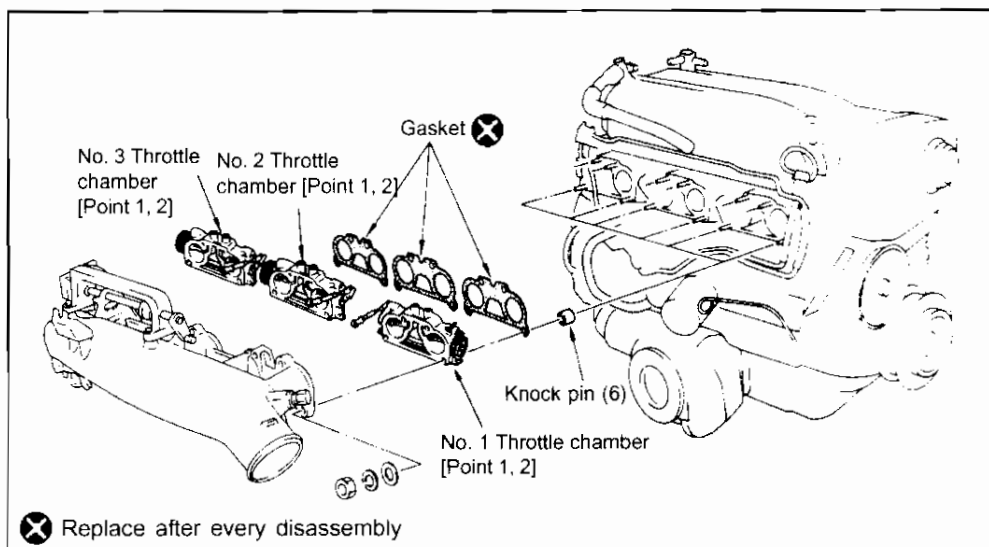

**Additional work required:**

- Collector ASSY removal and installation
- Canister hose

**[Point 1] Throttle chamber inspection**

- Check for any cracks and that supplemental air paths are not obstructed.

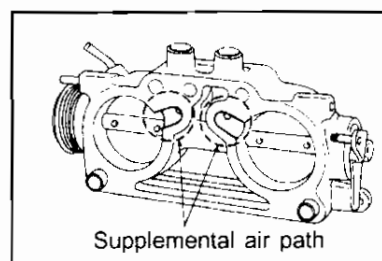

**[Point 2] Install throttle chamber**

- Install No. 1 to No. 3 throttle chambers.

**Caution:**

Do not make any mistake when installing the chamber.

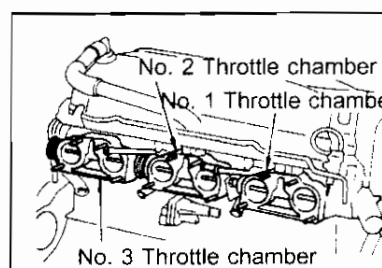

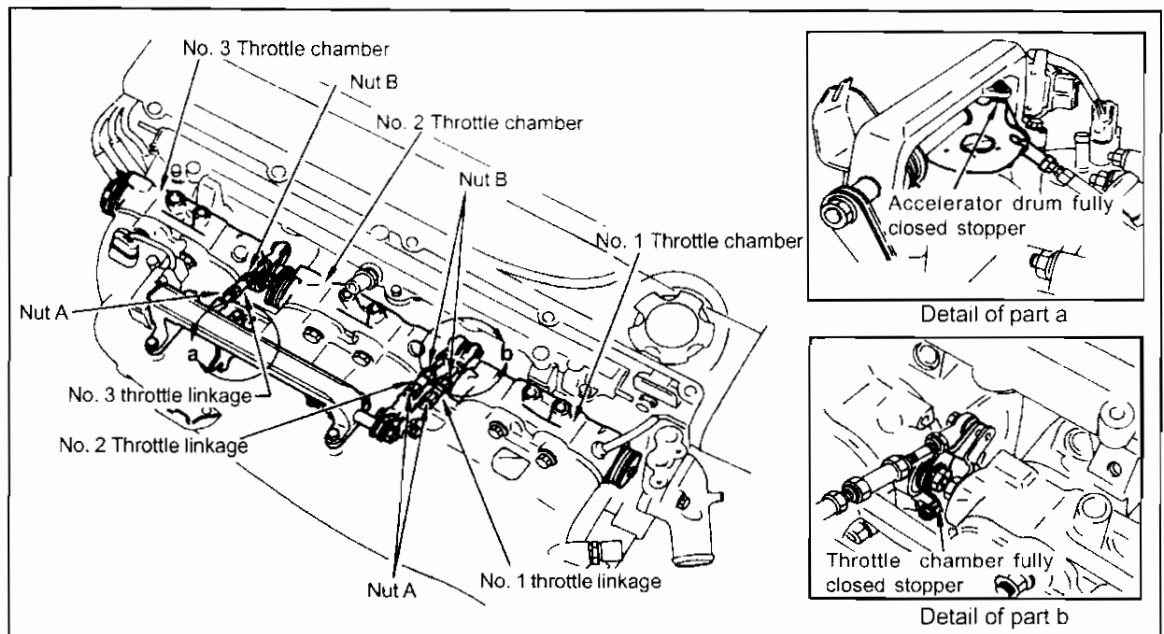

## 10-5 SIX IN-LINE THROTTLE CHAMBER LINK ADJUSTMENT

**[Point 1] Install accelerator work unit**

- Install six in-line throttle chamber and the accelerator work unit and connect No. 1, 2 and 3 throttle linkage.

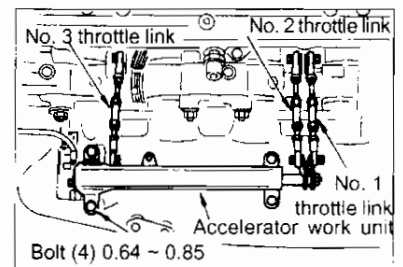
**[Point 2] 6 in-line throttle chamber link adjustment**

1. Loosen nuts A and B for each throttle link. Turn the centre adjustment of each throttle link anticlockwise to shorten the linkage.
2. Shorten each throttle link until acceleration drum contacts fully closed stopper on the accelerator work unit side.
3. Shorten each throttle link, so the throttle chamber lever opens wider than fully closed stopper on the throttle chamber side.

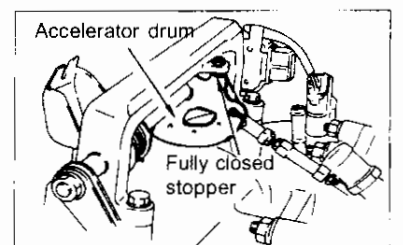
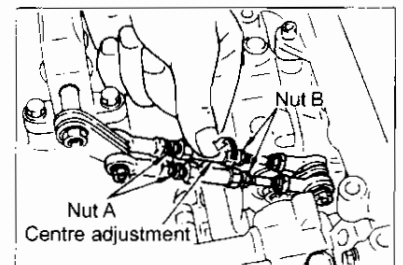
**Caution:**

- (1) Do not lock the nut A and B.
- (2) The throttle chamber lever opening angle should be adequate.

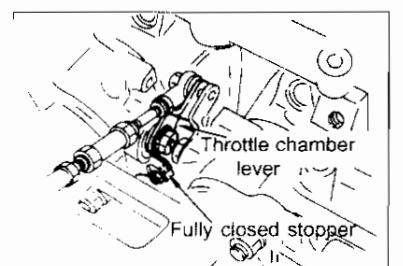

RB26DETT ENGINE

- Insert 1 mm thickness feeler gauge between the accelerator drum and fully closed stopper on the accelerator work unit side. Secure the accelerator drum so it does not move.

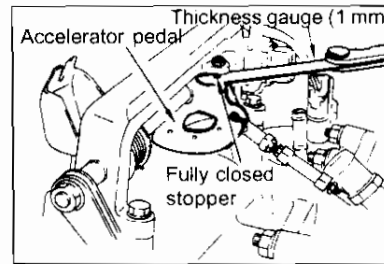

- With thickness gauge inserted, turn the centre adjustment in No. 2 throttle link clockwise to lengthen the throttle link until the throttle chamber lever contacts the fully closed stopper on the throttle chamber side.

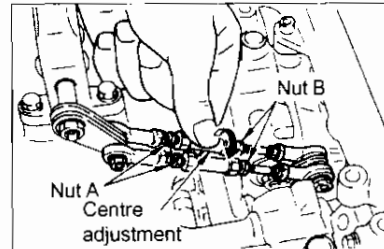

- When turning the throttle link with your fingers. You will feel resistance when the fully closed stopper contacts the throttle chamber lever. Shorten the throttle link to the point just before this resistance is felt.

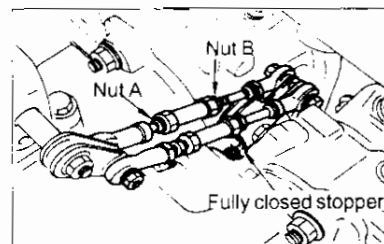

- Carry out the steps 4, 5, and 6 to adjust the No. 3 and 1 throttle links.

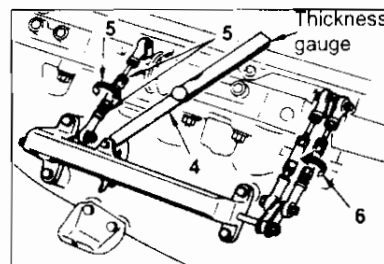

- Tighten the lock nut A and B after the adjusting three throttle links. After the nuts are tightened, No. 1 - 3 throttle links must turn with the same degree of smoothness.

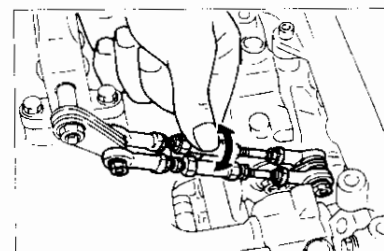

Caution:

Make sure the centre adjustment link will not rotate when the lock nut is tightened.

- Remove the thickness gauge from fully closed stopper on the accelerator work unit side.

Caution:

Do not adjust fully closed stopper nut.

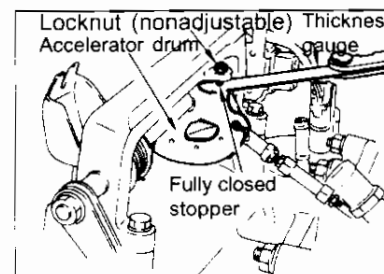

- Completely open and close the six in-line throttle chambers repeatedly and make sure that each throttle chamber moves smoothly.

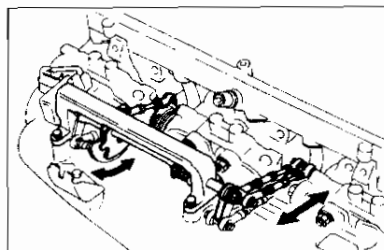

**10-6 INTAKE MANIFOLD ASSY**

**(1) Intake manifold ASSY removal and installation**

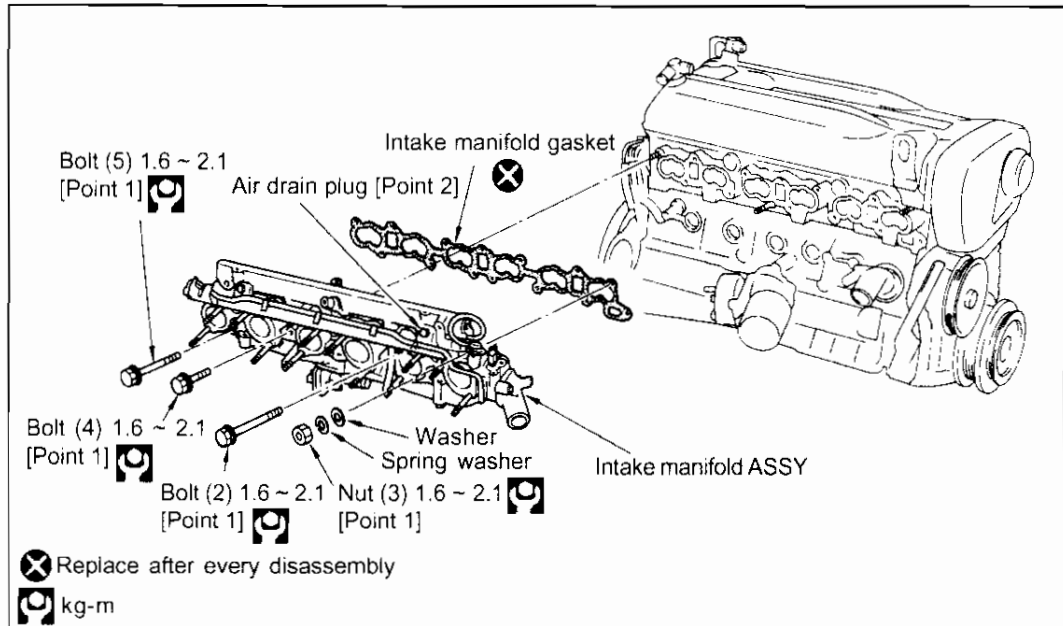

**Additional work required:**

- Collector ASSY removal and installation
- Throttle chamber removal and installation
- ECCS harness connector and all hoses
- Water outlet hose
- Blowby hose

**[Point 1] Remove & install Intake manifold ASSY bolts and nuts**

**Removal**

- Removal is the reverse order shown in the figure on the right.

**Installation**

- Install the bolts and the nuts in the order shown in the figure on the right. Tighten in gradual steps to uniform tightness.

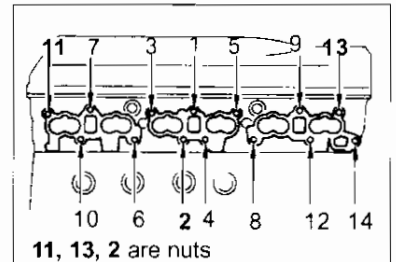

	Length : No. of bolts	Installation location
<b>Bolt length below head (mm)</b>	30 : 4	3, 5, 6, 8
	60 : 5	1, 4, 10, 12, 14
	65 : 2	7, 9

**[Point 2] Air drain plug**

- Carry out the operation when engine is cool.

**Caution:**

Do not remove the air drain plug when the engine is hot.

- When topping up the coolant, always remove the air drain plug to allow air within the engine to escape (this prevents overheating).

**Tightening torque (kg-m): 0.7 ~ 0.8**

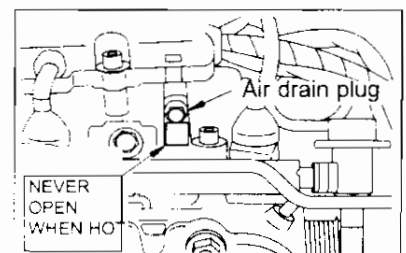

(2) Intake manifold disassembly & assembly

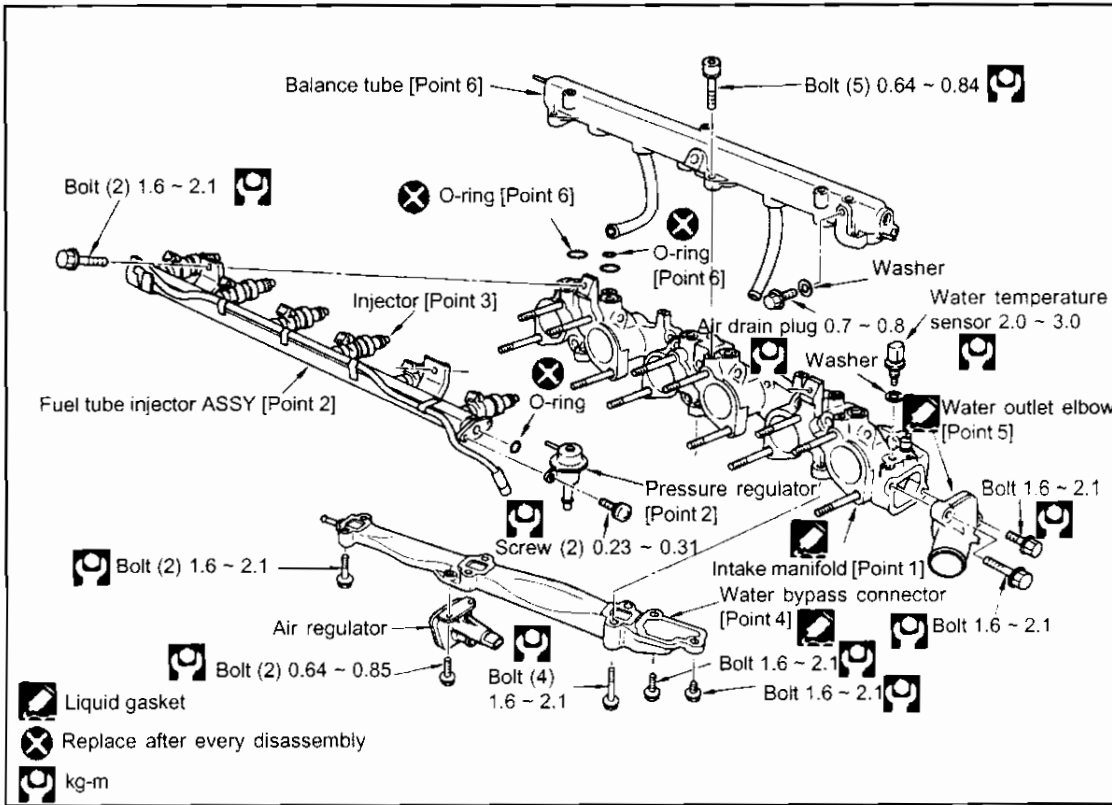

[Point 1] Intake manifold inspection

- Measure the intake manifold surface for distortions in six different directions (at opposite directions: up, down, right, left, horizontally and vertically) in several locations.

Limit (mm): 0.15

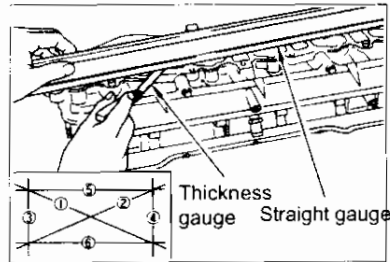

[Point 2] Fuel tube ASSY

- Replace O-ring with new ones when pressure regulator is removed and installed.

Caution:

Care must be taken not to scratch the fuel tube o-ring surface when installing the pressure regulator.

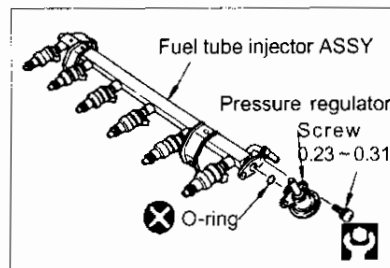

[Point 3] O-ring (for fuel injector pressure regulator)

Precautions when handling

- Never reuse O-rings.
- Coat the O-ring with engine oil (10W -30 or equivalent) or silicon oil (NUC silicon L45 or equivalent), but do not apply solvent as this may remove the oil coating.
- Avoid using dirty O-rings and do not allow dirt, dust or foreign objects to adhere to O-rings or other equipment surfaces.

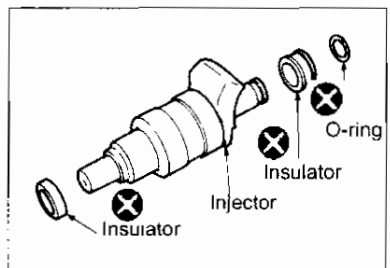

- Do not decenter or rotate the fuel injectors and the pressure regulator when inserting them into the fuel tube.
- Do not store O-rings in location subject to ozone, high temperature or in the direct sunlight.

#### [Point 4] Install and remove water bypass connector

##### Removal and cleaning

- Remove eight water bypass connector bolts. Insert driver in clearance between intake manifold and water bypass connector and move it lightly to remove connector.
- Use a scraper and remove liquid gasket.

##### Caution:

Also remove liquid gasket in the grooves.

- Wipe off mounting surface with white gasoline etc.

##### Installation

- Cut the nozzle end of liquid gasket (KP510 00150) in the position shown in the figure. Use a tube presser to apply gasket. Install bypass connector within 20 minutes of applying liquid gasket.
- Apply liquid gasket (KP10 00510) to water bypass connector surfaces in four locations, then install water bypass connector within 20 minutes.

##### Caution:

- (1) Apply liquid gasket coating 3.0 mm wide.
- (2) Coat on the inside of installation holes as shown.

**Tightening torque (kg-m): 1.6 ~ 2.1**

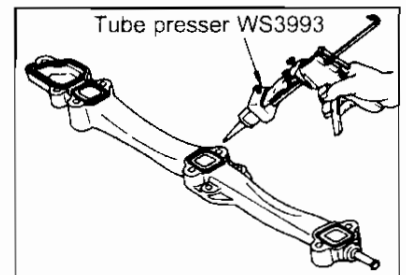
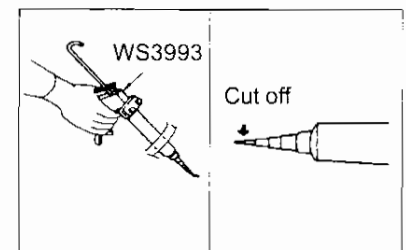
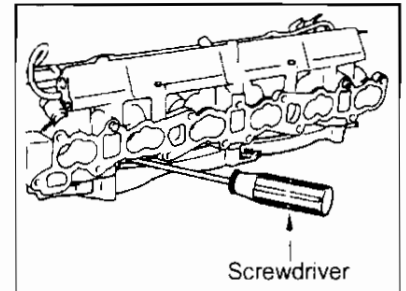

#### [Point 5] Water outlet elbow

##### Removal and cleaning

- Remove two water outlet elbow bolt and insert screw driver handle as shown. Move it up and down to remove the elbow.
- Remove liquid gasket from intake manifold and water outlet elbow by using a scraper.

##### Caution:

Also remove liquid gasket in the grooves.

- Wipe off mounting surface with white gasoline etc.

##### Installation

- Cut the nozzle end of liquid gasket (KP510 00150) in the position shown in the figure. Use a tube presser to apply the gasket.
- Apply the liquid gasket (KP10 00510) to intake manifold surfaces in four locations, then install within 20 minutes.

##### Caution:

- (1) Apply the liquid gasket coating 3.0 mm wide.

**Tightening torque (kg-m): 1.6 ~ 2.1**

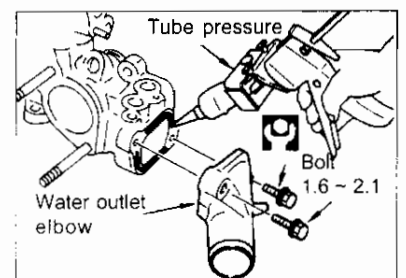
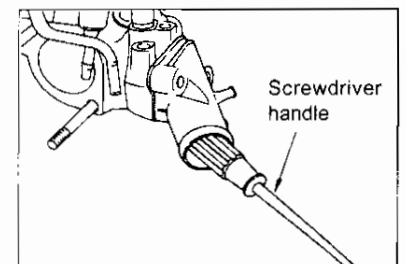

**[Point 6] Remove and install balance tube**

**Removal**

- Check the size of the O-ring when removing balance tube.

**Installation**

- Always replace the O-ring with new ones when installing balance tube.
- There are three different O-ring sizes. Make sure to install the correct size.

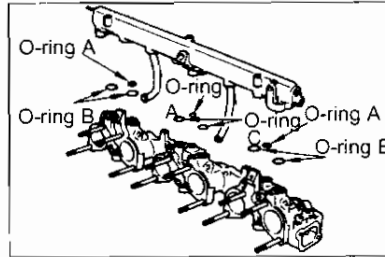

	Number of unit	Installation location
<b>O-ring A (small)</b>	3	Cylinder 1, 2, 3, 4, 5, 6
<b>O-ring B (large)</b>	4	Cylinder 1, 2, 5, 6
<b>O-ring C (medium)</b>	2	Cylinder 3, 4

- Be careful not to pinch the O-rings during installation.

**10-7 TURBOCHARGER ASSY**

**(1) Turbocharger ASSY removal & installation**

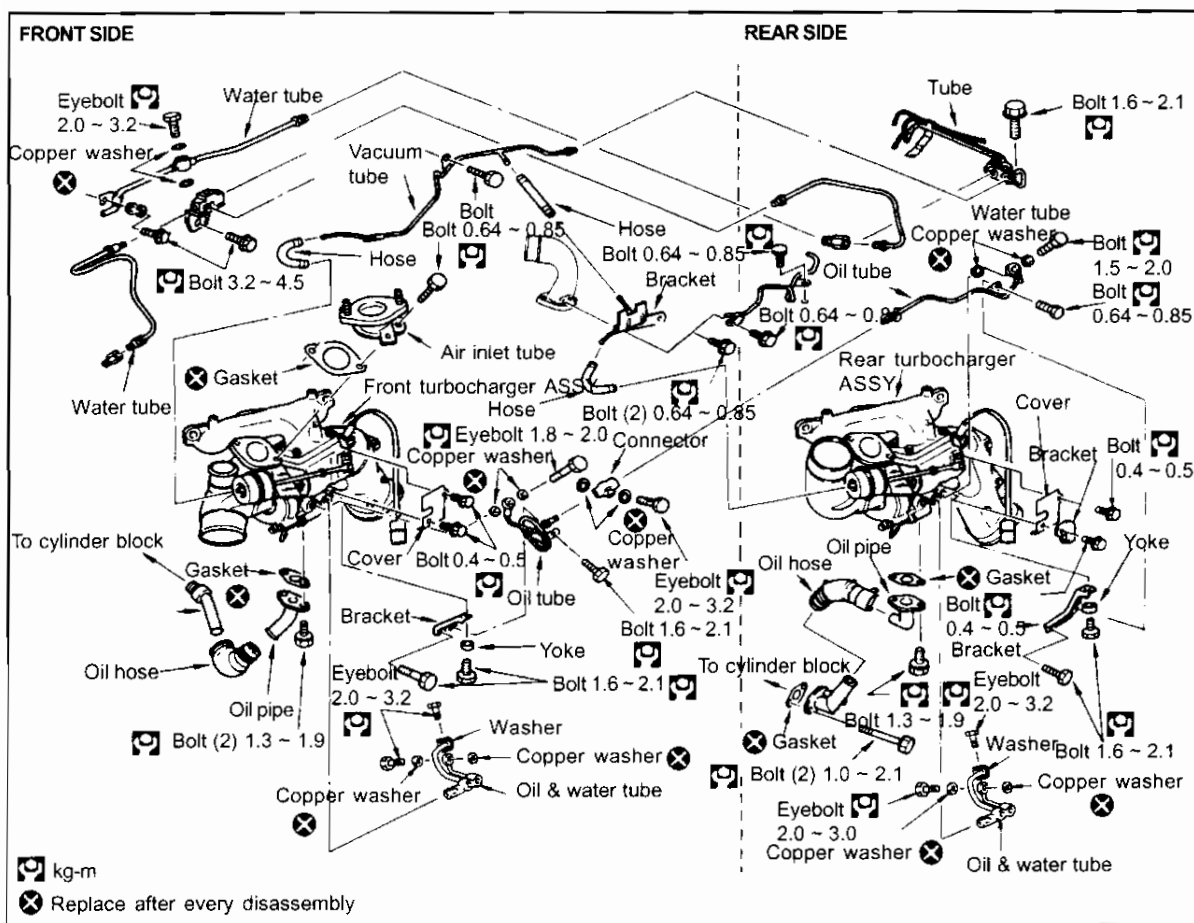

**Additional work required:**

- Remove and install undercover
- Drain cooling water
- Separate exhaust front tube
- Remove and install exhaust gas sensor connector
- Intercooler air inlet tube and hose
- Air inlet hose

**Note:**

Also remove cooling water from engine drain plug.

(If water is only drained from the radiator drain cock, the water inside cylinder block will not be drained completely).

**(2) Front turbocharger ASSY removal & installation****Removal sequence**

- (1) Loosen the flare nuts of tubes A and B.
- (2) Remove bolts and detach tube A.
- (3) Loosen flare nuts of tubes C and D on the turbo side.
- (4) Remove hose B and bolts.
- (5) Remove bolts and detach tube E.
- (6) Remove three bolts, cover and ground cable.
- (7) Remove two bolts and detach tube H. Make sure that bolt mounted on upper side is shorter than lower side.
- (8) Remove three bolts, cover and ground cable.
- (9) Remove oil return hose.
- (10) Remove three bolts and detach bracket.
- (11) Remove four turbocharger nuts.
- (12) Lower turbocharger carefully.
- (13) Remove six exhaust manifold nuts.
- (14) Pull the exhaust manifold in direction 1 and then raise it in direction 2 to avoid turbocharger stud.
- (15) Remove exhaust manifold.
- (16) Pull out turbocharger.

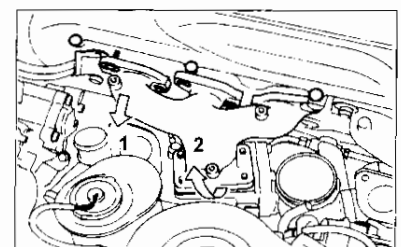
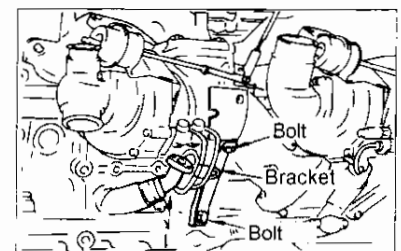
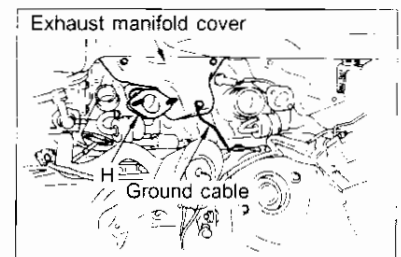
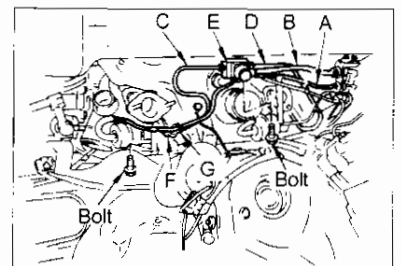
**Installation sequence**

- Installation is the reverse of the removal sequence.
- Place turbocharger in bottom of the engine compartment before installing the exhaust manifold.

**(3) Rear turbocharger ASSY removal & installation**

**Additional work required:**

- Front turbocharger ASSY removal and installation

**Removal sequence**

- (1) Remove front turbocharger and the exhaust manifold ASSY.
- (2) Remove two nuts and the clip securing bolt, and separate the tube A.
- (3) Remove three bolts and detach exhaust manifold cover.
- (4) Remove eyebolt B, C and E.
- (5) Remove two bolts and separate tube D from cylinder block side.
- (6) Remove three bolts and detach bracket.

The sequence after this step is same as number 11 to 16 of the front turbocharger removal and installation.

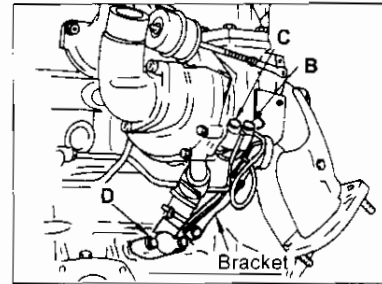
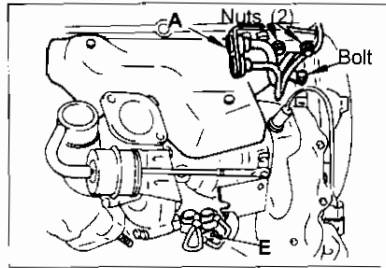

**Installation sequence**

- Installation is reverse of removal sequence.
- Loosen the water tube flare nut before installing eyebolt B.

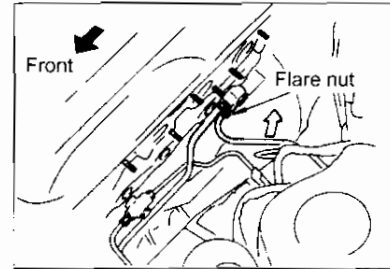

**(4) Turbocharger ASSY disassembly & assembly**

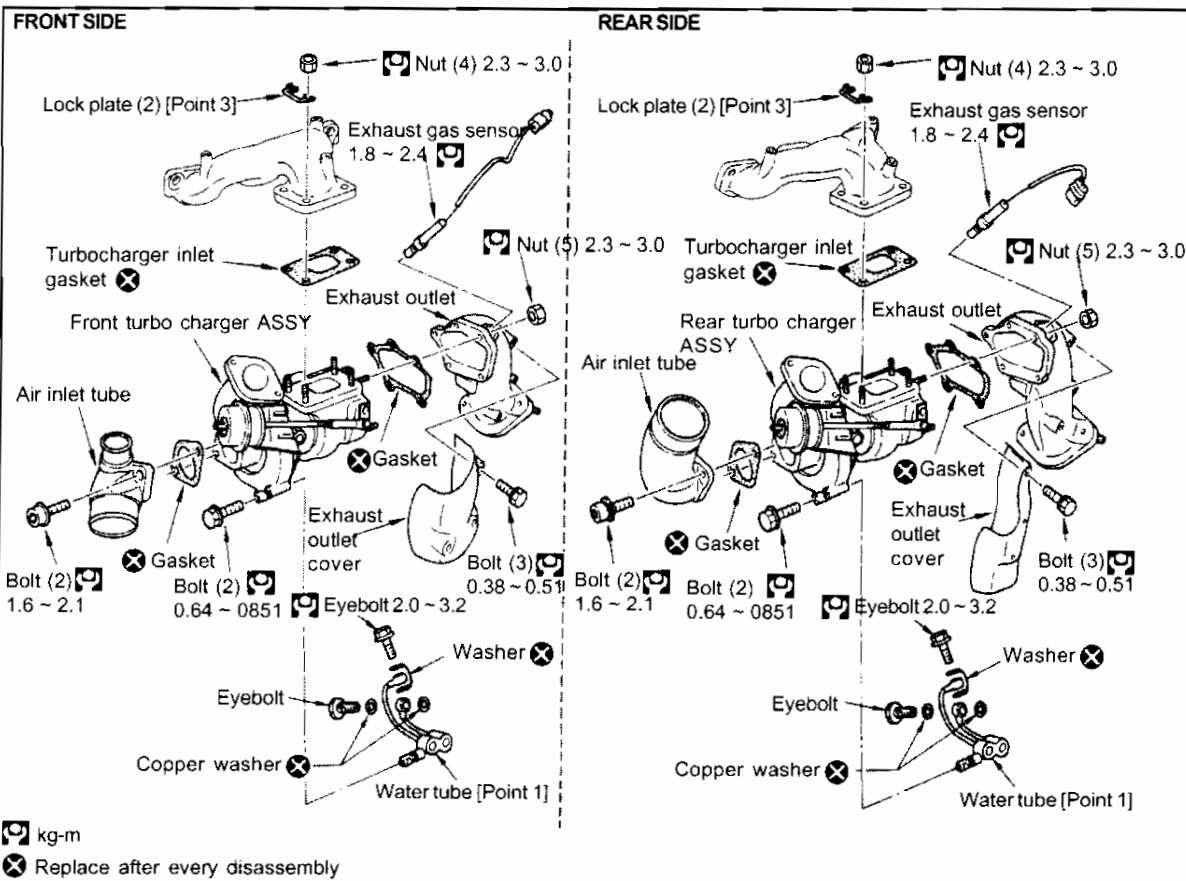



**Additional work required:**

- Turbocharger ASSY removal and installation

**[Point 1] Water tube inspection**

- After cleaning the water inlet and outlet tubes with radiator cleaner, blow with compressed air and check for rust or any clogging.

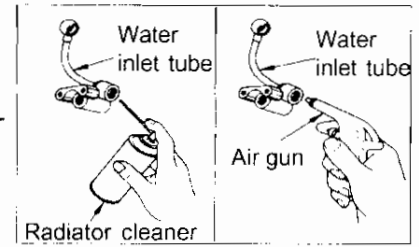

**[Point 2] Oil feed tube inspection**

- After cleaning the oil feed tube with engine conditioner, blow with compressed air and check for any clogging.

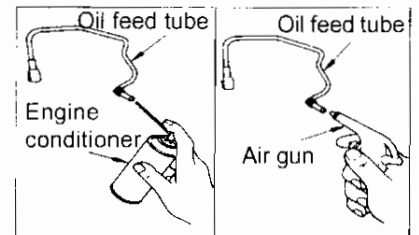

**[Point 3] Remove and install lock plate**

- Spread the lock plate pawls with a screwdriver and loosen nuts.
- Position lock plates and turbocharger mounting nuts. After tightening the nuts, bend lock plate pawls onto the nuts.

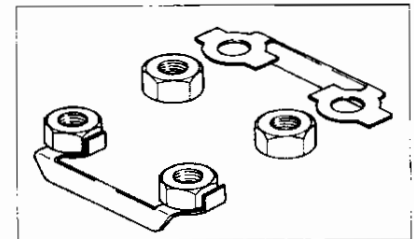

**[Point 4] Eyebolt determination**

- Oil feed (turbocharger side) eye bolts are stamped 'J'.

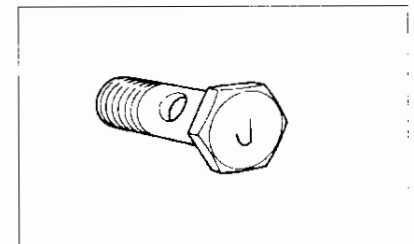

**(5) Turbocharger unit inspection**

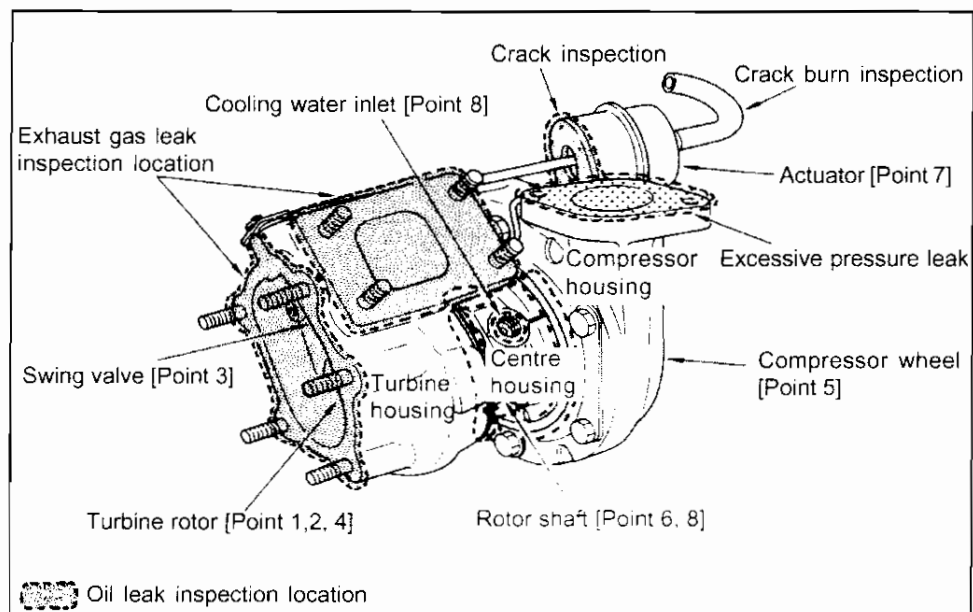

**[Point 1] Rotor shaft inspection**

- Make sure the rotor shaft rotates smoothly with no heaviness or dragging when turned by finger.

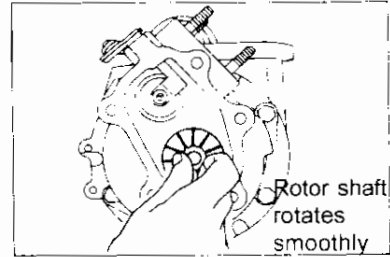

**[Point 2] Turbine rotor inspection**

- Oil must not adhere to surface.
- There is no carbon accumulation.
- The vanes of the turbine must not be bent.
- There is no interference with turbine housing.

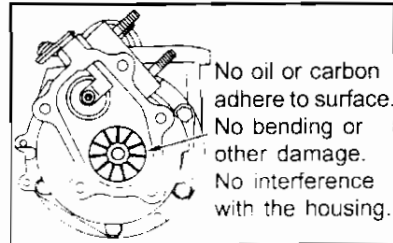

**[Point 3] Swing valve inspection**

- Remove actuator rod pin and make sure the swing valve moves smoothly without deformation or cracks.
- Make sure there are no misaligned seating surface in turbine housing.

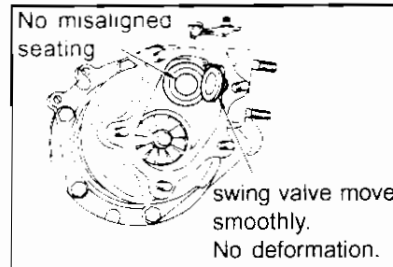

**[Point 4] Rotor shaft play inspection**

- Set the dial gauge and measure play and thrust clearance.
- Insert the dial gauge in oil return hole and measure rotor shaft play.

Rotor shaft play (mm)	0.056 ~ 0.127
Thrust clearance (mm)	0.013 ~ 0.096

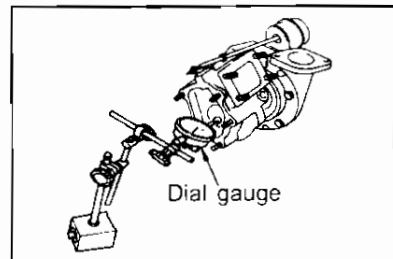

**[Point 5] Compressor wheel inspection**

- Oil must not adhere to suction inlet.
- There must be no interference with compressor housing.
- Wheel must not be bent or damaged.

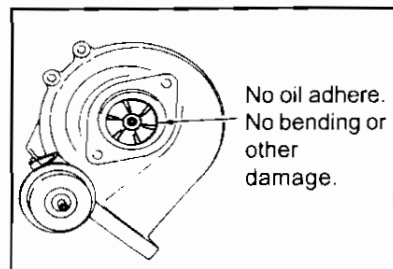

**[Point 6] Rotor shaft inspection**

- There must be no carbon sludge accumulation.

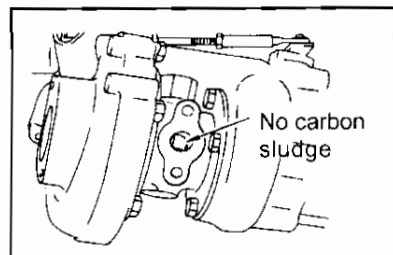

## RB26DETT ENGINE

**[Point 7] Swing valve controller inspection**

- Connect the swing valve controller rubber hose on the actuator side.
- Check the swing valve controller when the actuator rod is installed or removed.
- Check to see if the controller rod will operate when the compressed air pressure (approx.  $0.7 \sim 0.8 \text{ kg / cm}^2$ ) is applied. Stop blowing air as soon as rod operates.

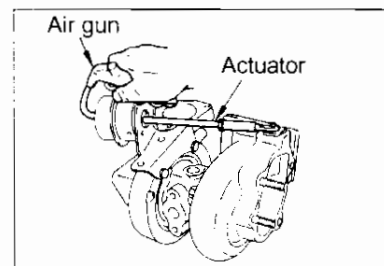
**[Point 8] Oil & cooling water inlet and outlet cleaning**

- Use engine conditioner to clean the oil feed and return passages.
- Use radiator cleaner to clean cooling water feed and return passages.

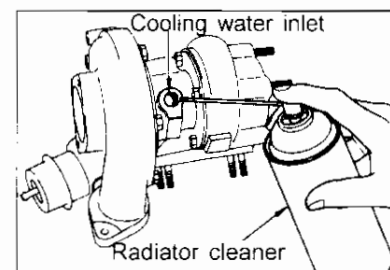

- Clean with air gun.

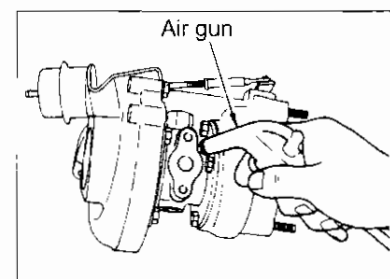

- Clean the compressor wheel, turbine wheel, compressor =housing and turbine housing with same methods.

**(6) Turbocharger failure diagnosis (Oil leaks, smoke (white or blue smoke), lack of power, poor acceleration, abnormal noise)**

Points to be checked before diagnosis:

1. The engine oil level must be between the MIN and the MAX marks on the oil level gauge. (When the engine oil level is higher than MAX line, the engine oil will flow into intake duct through the blowby gas recirculation pass and the turbocharger may be determined to be malfunctioning).
2. Check with customer to determine if oil is cooled when idling after driving. If any malfunction in the following chart is detected in a unit inspection, replace the turbocharger ASSY.

Inspection location	Inspection result	Possible associated phenomenon			
		Oil leak	Smoke	Abnormal noise	Lack of power / Poor acceleration
Turbine rotor	Oil on rotors	△	◎	△	△
	Carbon has accumulated	△	◎	○	○
	Rotor scrapes against the housing	△	○	◎	○
	Turbine vanes are bent or folded			◎	◎
Compressor wheel	Suction inlet is dirty with oil	○	○		
	Rotor scrapes against the housing	△	○	◎	○
	Turbine vanes are bent or folded			◎	◎
Turbine and compressor Rotor shaft play inspection	There is resistance or scraping when rotated by finger		△	△	○
	Rotation by finger is not possible				◎
	Considerable shaking between rotor shaft and turbo ASSY	△	△	○	△
Look through oil hole (inspect interior with pen light)	Carbon sludge has accumulated in waste oil hole	△	◎	△	△
Swing valve operation (use air gun or air pump)	The valve does not move smoothly when pressure is applied gradually. (usually opens at pressure greater than 0.6 ~ 0.7 kg/cm <sup>2</sup> )				◎

◎ Highly possible    ○ Possible    △ Slightly possible

10-8 EXHAUST MANIFOLD ASSY REMOVAL & INSPECTION

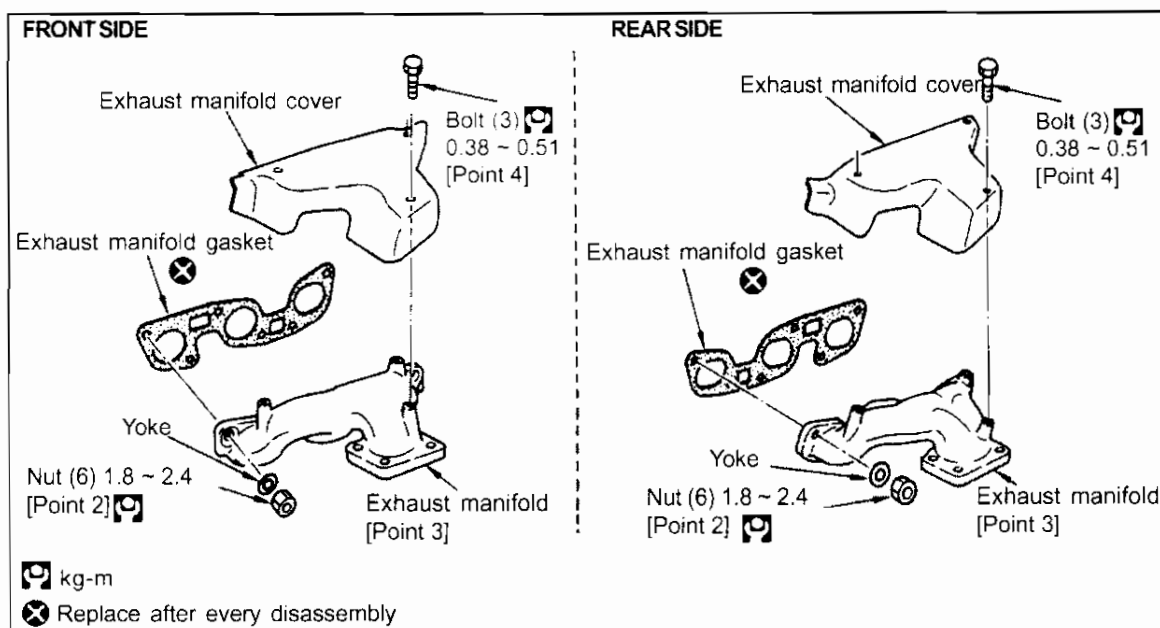

**Additional work required:**

- Turbocharger removal and installation
- Gas leak inspection [Point 1]

**[Point 1] Gas leak inspection**

- After removing exhaust manifold, make sure there are no traces of gas leaks from any parts.
- After the installation, crank the engine and check for any gas leaks.

**[Point 2] Remove and install exhaust manifold nuts**

- Removal is the reverse of installation sequence shown in the diagram on the right.

**Installation**

- The installation sequence is shown in the diagram on right.

**Tightening torque (kg-m): 1.8 ~ 2.4**

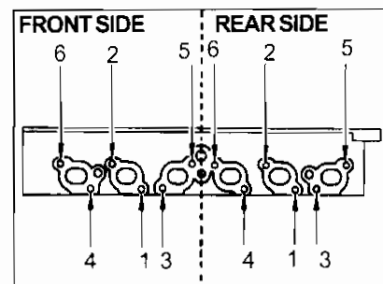

**[Point 3] Exhaust manifold inspection**

- Measure the exhaust manifold surface for distortions in six separate directions (opposite directions, up, down, left, right, horizontally and vertically) in a number of locations.

**Limit (mm): 0.3**

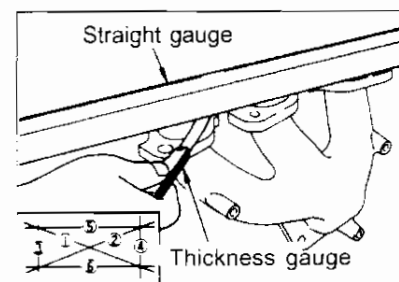

## RB26DETT ENGINE

**[Point 4] Install exhaust manifold cover**

- Attach the exhaust manifold cover bolts in the following sequence. (both front & rear)

1. Temporarily tighten bolts for positions indicated by A.
2. Tighten bolts in the positions indicated B.
3. Tighten bolts in holes A to specified tightening torque.

**Tightening torque (kg-m): 0.38 ~ 0.51**

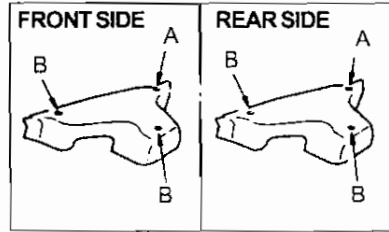
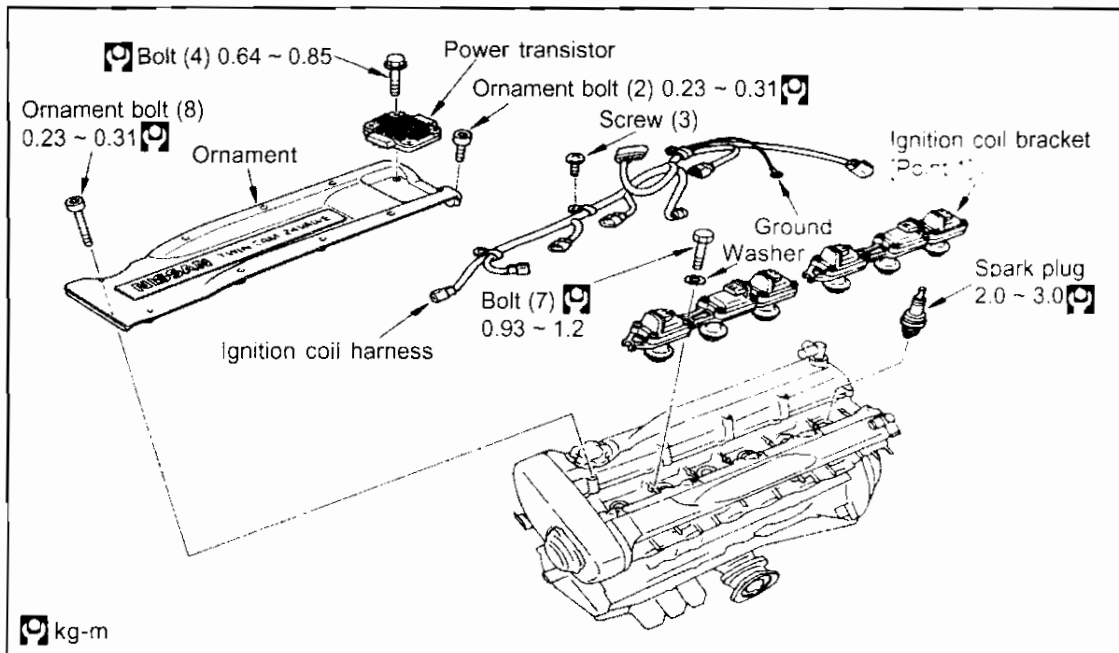
**10-9 SPARK PLUGS****Additional work required:**

- Remove and install air inlet pipe
- Remove and install blowby hose

**[Point 1] Remove and install ignition coil bracket****Removal**

- Hold the coil body when removing the ignition coil bracket.

**Caution:**

Do not hold the coil connector when removing it.

**Installation**

- Make sure to attach the ignition coil harness when installing the ignition coil bracket to the cylinder head.

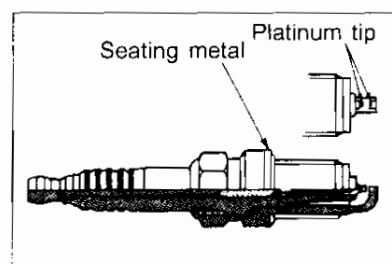
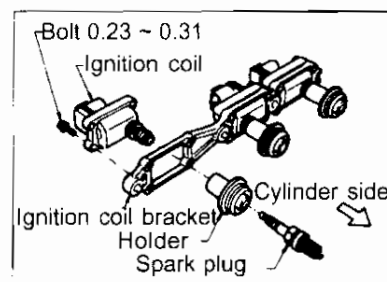
**[Point 2] Spark plug maintenance**

- Gap inspection and adjustment is not necessary as a platinum tip is used.
- Replace the plug every 100,000 km.
- When using a compressed air spark plug cleaner, clean the plugs at maximum pressure of 6 kg/cm<sup>2</sup> for no more than 20 seconds.

**10-10 ROCKER COVER REMOVAL & INSTALLATION**

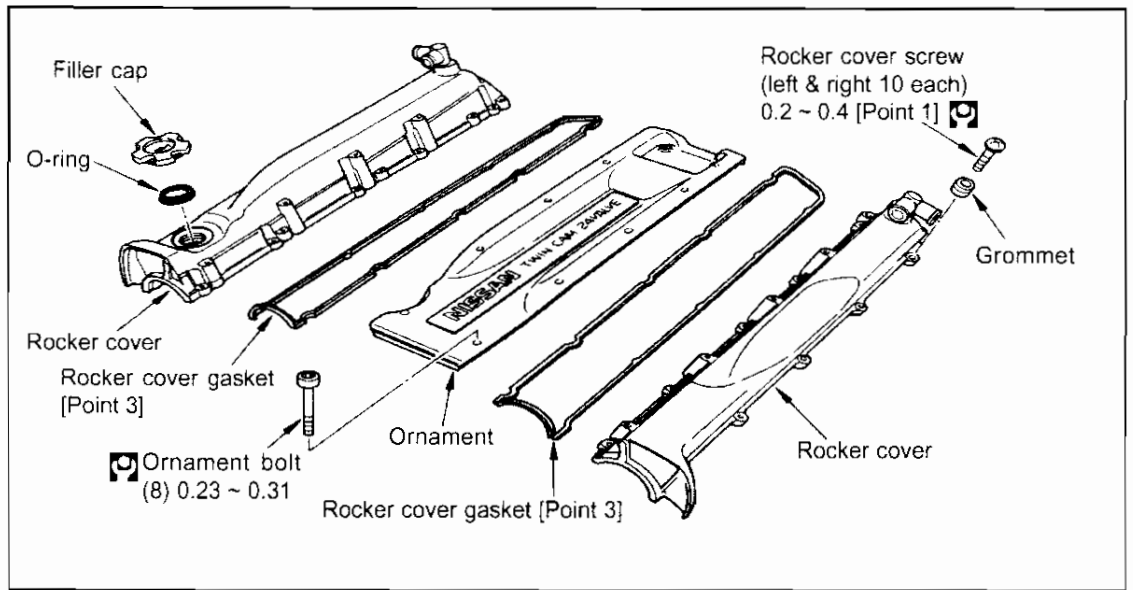

**Additional work required:**

- Remove and install air inlet pipe
- Remove and install blowby hose

**[Point 1] Remove and install rocker cover screw**

- Removal**
- Remove the screws in reverse sequence shown in the figure on the right.

**Installation**

- Perform installation in the sequence shown in the figure on the right.

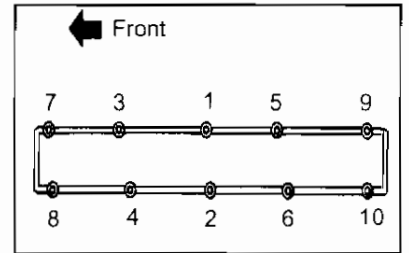

**[Point 2] Rocker cover installation surface inspection**

- Check that no oil, dirt or foreign material adheres to the cylinder head installation surface.

**[Point 3] Install rocker cover gasket**

- Make sure the rocker cover gasket is positioned securely in groove without twisting, pinching or protrusion.

10-11 TIMING BELT REMOVAL & INSTALLATION

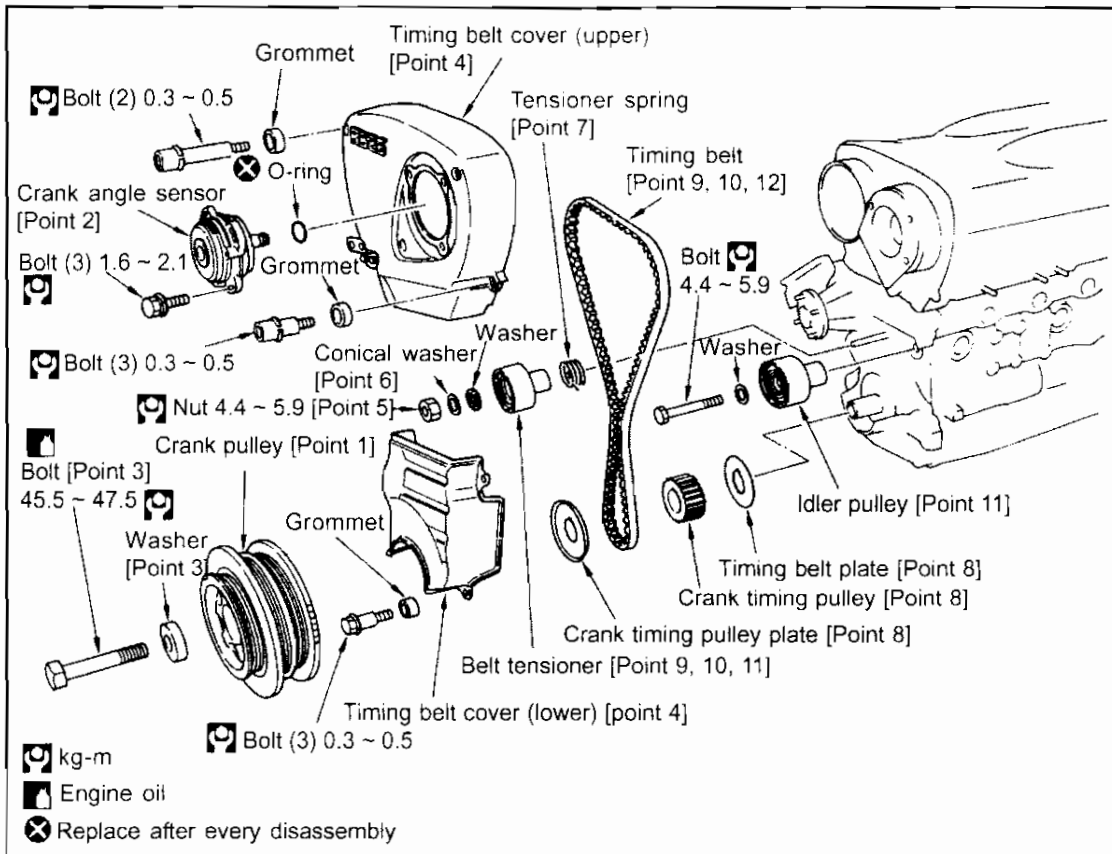

**Additional work required:**

- Drain cooling water
- Remove and install
  - Under cover
  - Radiator, fan shroud
  - Cooling fan
  - Supplemental belts
  - Water pump pulley
  - Spark plugs
- Check No. 1 cylinder compression T.D.C position [Point 1]
- Install ring gear stopper [Point 3]

**[Point 1] No. 1 cylinder pressure T.D.C (top dead enter) inspection**

- Align crank pulley timing mark and belt cover timing indicator (0° position). At this time, No. 1 cylinder is in compression T.D.C position when the camshaft is located as described in the following situations.

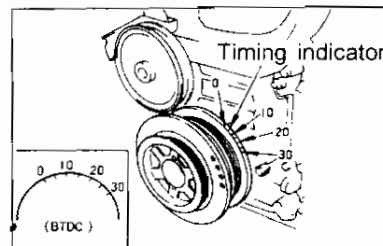



- No. 1 cylinder is at compression top dead centre (T.D.C) when both intake and the exhaust side cams do not move the valve lifters.

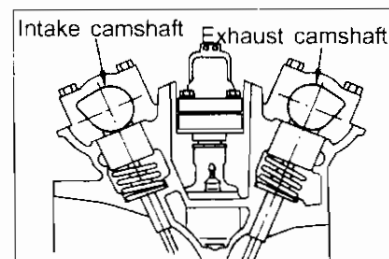

- Remove the locker cover oil filler cap from intake side and check that front end of the camshaft faces intake side.

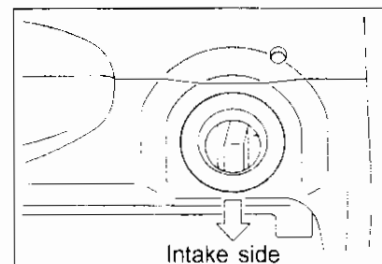

**[Point 2] Install crank angle sensor**

- Apply chassis grease to drive unit (spline) during installation.
- There is a flange inside the drive unit spline so the spline has only one insertion position. Check the alignment visually before assembly.
- Check that the crank angle sensor can be easily inserted in belt cover holes and sensor moves lightly to right and left, then tighten the bolts.
- When the sensor doesn't move lightly, loosen belt cover bolts to position when the crank angle sensor was inserted. Move the belt cover lightly horizontally and vertically to align it so the belt cover holes and the camshaft centre are aligned. Then tighten the bolts so the crank angle sensor moves lightly.

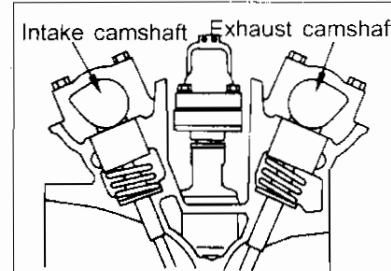
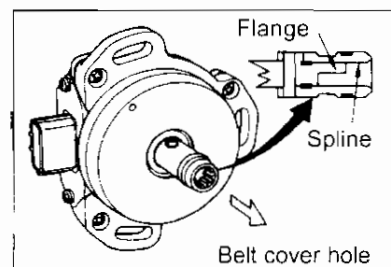

**[Point 3] Remove & install crank pulley and the bolt**  
**Removal**

- Remove the starter motor and attach the ring gear stopper.

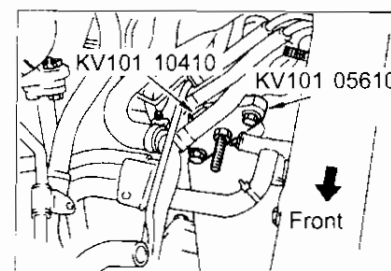

- Use a pulley puller (steering wheel puller) to remove crank pulley (bolt size: M6 x 1.0 length below head approx. 50 mm).

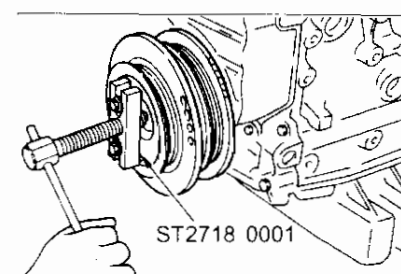

**Installation**

- Position the washer for the crank pulley bolts so the surface not marked R contacts the crank pulley side and then assemble.
- Apply engine oil to the threads of the crank pulley bolts.

**Tightening torque (kg-m): 45.5 ~ 47.5**

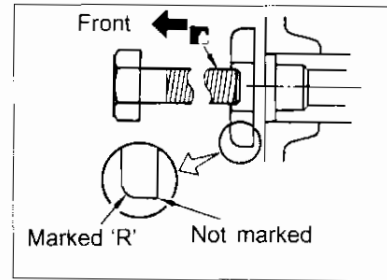

**[Point 4] Remove & install timing belt cover**

**Removal**

- The timing belt cover is separated into upper and lower parts. After crank angle sensor is removed, remove the timing belt cover in the order of upper and then lower.

**Installation**

- Installation is in reverse sequence of removal procedures.

**Caution:**

Care must be taken not to scratch or damage the dried liquid packing when removing and installing the timing belt cover.

**Tightening torque (kg-m): 0.3 ~ 0.5**

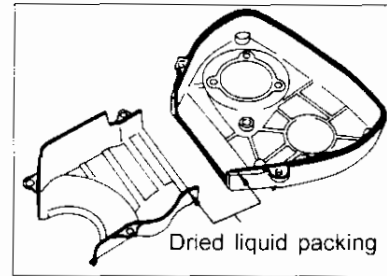

**[Point 5] Remove & install belt tensioner nuts**

- Secure the tensioner with hexagonal wrench when removing and installing the belt tensioner nuts.

**Caution:**

Do not loosen inserted stud when disassembly.

**Tightening torque (kg-m): 4.4 ~ 5.9**

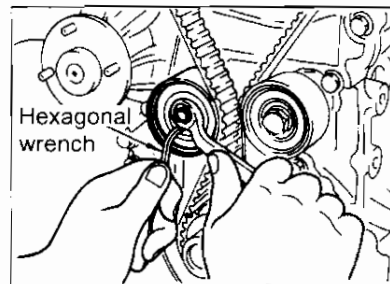

**[Point 6] Install conical washer**

- Pay attention to installation direction of the conical washers. The washer should be set with face with chamfered side facing the tensioner pulley side.

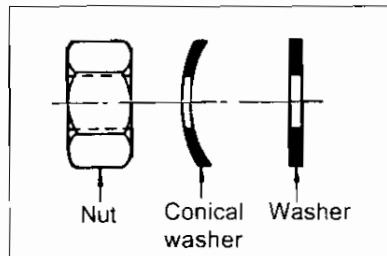

**[Point 7] Install tensioner spring**

- Assemble the tensioner spring to the belt tensioner pulley as shown in the figure.
- The tensioner spring must be assembled together with the belt tensioner pulley in the cylinder block.

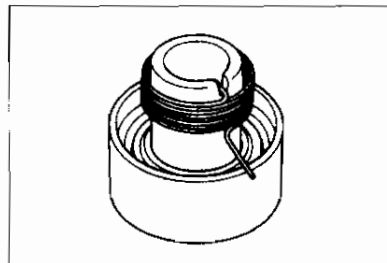

- Hook the tensioner spring on the upper side of the tensioner spring stud when the tensioner pulley is free.

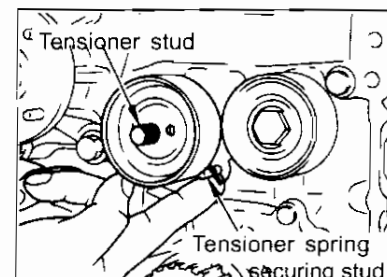

**Tensioner spring specifications**

Spring wire diameter	Set angle (a)	Free angle (-)	Classification paint
1.8 mm	Approx. 20°	Approx. 163°	Yellow-green

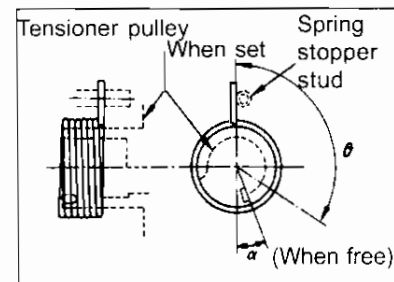

**[Point 8] Install crank timing pulley & plate**

- Care must be taken of the rear and front positioning when installing timing belt plate, the crank timing pulley and the timing pulley plate.

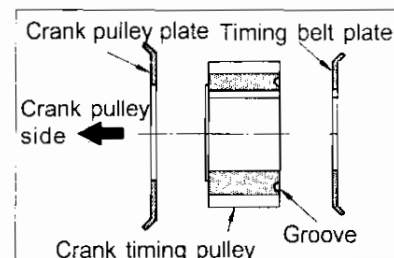

**[Point 9] Timing belt alignment mark verification and installation.**

- Paint a mark on the belt that indicates rotation direction if paint on the upper belt is unclear when disassembly.
- Position the alignment marks on the intake and the exhaust cam pulleys with the respective belt cover alignment marks. (No. 1 cylinder is at T.D.C)
- Position the alignment mark on the crank timing pulley with the respective oil pump housing alignment marks. At this time the groove must be straight up (no. 1 cylinder is at T.D.C).
- Move the belt tensioner clockwise 70 ~ 80 degree angle, and secure it temporarily with the belt tensioner nut.
- Install the belt by aligning the timing belt and the pulley marks. Align the number of ridges of exhaust cam pulley alignment mark and the crank pulley (inner) alignment mark as shown in the figure on right.
- After loosening the nuts and adjusting the belt tension, secure the tensioner with the hexagonal wrench so it will not rotate together and tighten the nut.

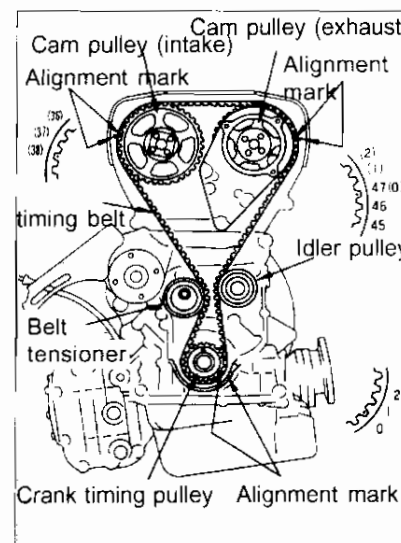

**Caution:**

- (1) Make sure the timing belt engages correctly with the pulley and does not float when assembling the timing belt.
- (2) Replace belts whenever possible when disassembly is performed.

**[Point 10] Timing belt tension adjustment**

- Remove the spark plug and align the timing belt alignment mark and the pulley marks and install timing belt on to each pulley.
- Loosen the tensioner securing nut so the belt tension is applied by the tensioner spring.
- In this condition, rotate the crank pulley clockwise more than two turns to check the belt movement and stop slowly at No. 1 cylinder compression T.D.C point.
- Insert the hexagonal wrench in hexagonal hole. Hold the tensioner by hand so the tensioner does not move, and tighten the tensioner securing nut to specified tightening torque.

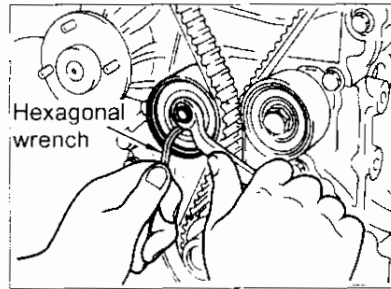

**Tightening torque (kg-m): 4.4 ~ 5.9**



- The initial tension on the belt in this condition should be approximately 20 kg.

**[Point 11] Install idler & tensioner pulley**

- Do not loosen inserted studs when disassembly. If studs are loosened, coat inserted stud with locktite solution (Japan Locktite KK) or equivalent.

**[Point 12] Timing belt inspection**

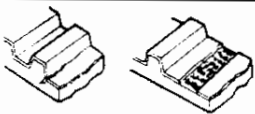
- Replace timing belt if any problems are indicated at the inspection.

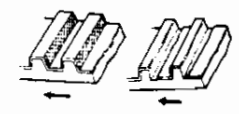
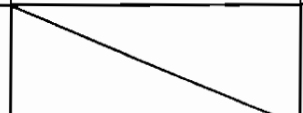
Item	Condition	Cause
Tooth missing Cracked tooth		Camshaft lock Crank sensor lock
Cracks on rear side		Tensioner lock Engine overheat Interference with belt cover etc.
Wear and cracks on the side		Belt misalignment Belt plate malfunction
Worn teeth		Sliding motion resistance in crank sensor and the camshaft
Oil or water adhesion		Oil seal malfunction Water leaks in water pump

**Caution:**

Do not twist or bend the timing belt . Make sure there is no oil film or water on the belt.

10-12 CYLINDER HEAD ASSY

(1) Install & remove cylinder head ASSY

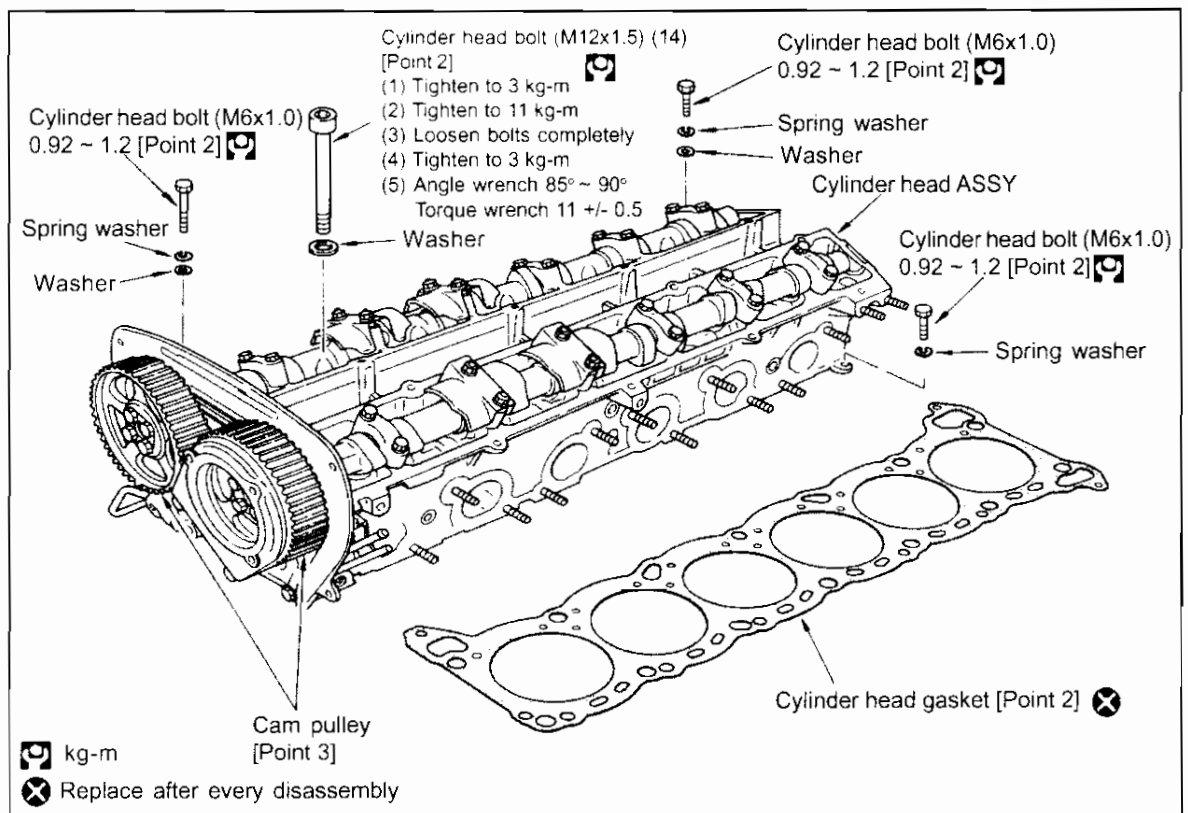

**Additional work required:**

- Drain and refill cooling water [Point 1]
- Remove and install;
  - Collector
  - Throttle chamber
  - Intake manifold
  - Turbocharger, exhaust manifold
  - Timing belt
  - Rocker cover
  - Spark plugs
- Install No. 1 cylinder compression T.D.C position [Point 3]

**[Point 1] Drain & refill cooling water**

**Removal**

- Remove cooling water completely from the cylinder block drain plug.

**Caution:**

- Make sure cooling water will not enter exhaust front tube.

**Refill**

- Refer to "Cooling water filling procedures" for details.

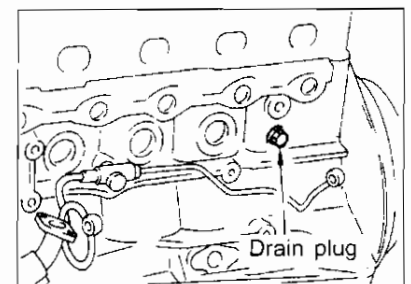

RB26DETT ENGINE

**[Point 2] Remove and install cylinder head bolts**  
**Removal**

- Remove the bolts in reverse sequence to the figures on right.

**Installation**

- Install the bolts in sequence shown in the figure on right.
- The cylinder head bolt (M12x1.5) are torqued by two-step method. Tighten the bolts in two steps.

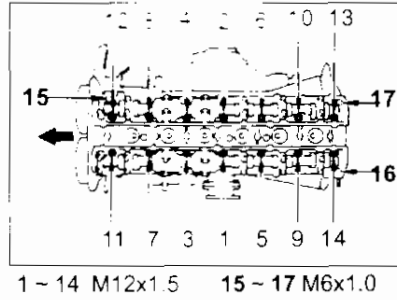

- (1) Tighten to 3 kg-m.
- (2) Tightened to 11 kg-m.
- (3) Loosen bolts completely 0 kg-m.
- (4) Tighten to 3 kg-m.
- (5) Turn bolts 85 ~ 90° clockwise when angle wrench is used.  
Tighten bolts to 10.5 ~ 11.5 kg-m when torque wrench is used.

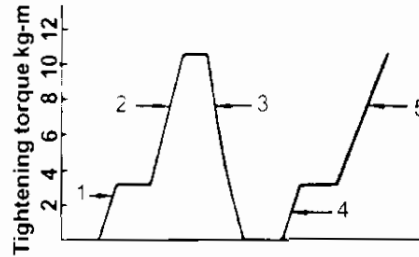

**Caution:**

When angle wrench is not used, never attempt to approximate the tightening angle visually.

- Take care not to hit or scratch the gasket seat and the bore grommet when the gasket is installed.
- Clean the cylinder head lower surface and the cylinder block upper surface to remove all water, oil and foreign objects when gasket is installed. Use compressed air gun to blow out the bore holes.

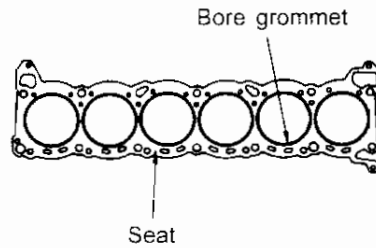

**[Point 3] No. 1 cylinder compression T.D.C verification**

- Before installing the cylinder head ASSY to cylinder block, the crank pulley and the cam pulley must be positioned at the No. 1 cylinder compression T.D.C position.
- Align the crank pulley timing mark and the timing belt cover timing indicator (0° position).

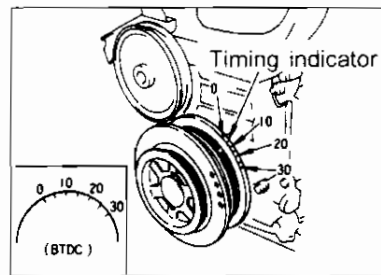

- Align the intake and the exhaust cam pulley alignment mark to respective belt cover alignment marks.

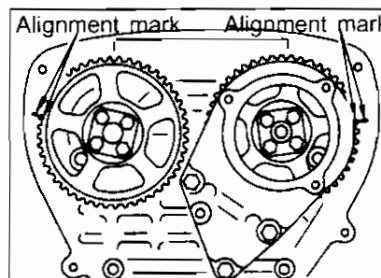

**(2) Cylinder head ASSY disassembly & assembly**

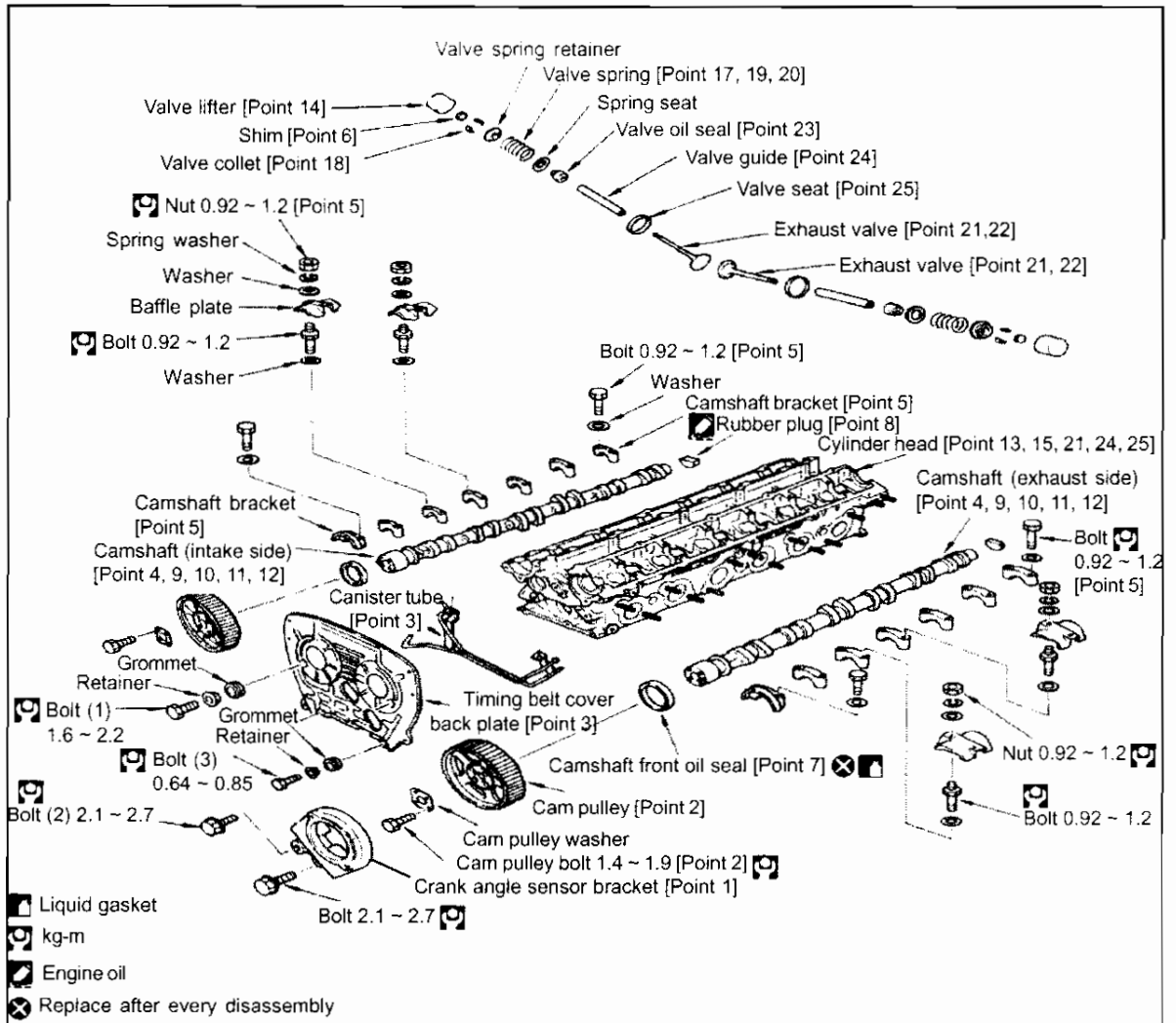

**Additional work required:**

- Remove and install cylinder head ASSY

**[Point 1] Instal crank angle sensor bracket**

- The crank angle sensor bracket is positioned onto the cylinder head by using know pins. Align the positions correctly when installing the crank angle sensor.  
**Crank angle sensor bracket bolt tightening torque (kg-m): 2.1 ~ 2.7**

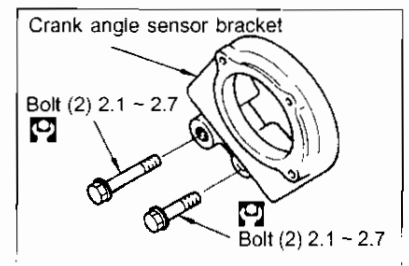

**[Point 2] Remove & install cam pulley**  
**Removal**

- Fix pulley with a pulley holder or sprocket wrench and remove cam pulley bolts.

**Pulley holder:** KV101 09900 or  
KV101 09300,  
ST3152 0000,  
ST3153 0000

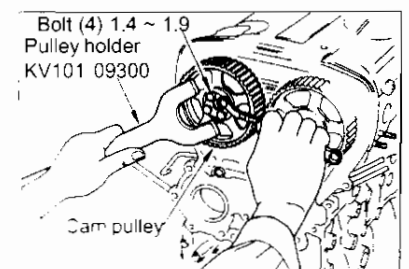

**Installation**

- Align the cam pulley knock pin hole and the camshaft knock pin to install cam pulley.
- Use pulley holder or sprocket wrench to tighten cam pulley bolt.

**Cam pulley bolt tightening torque (kg-m): 1.4 ~ 1.9**

- To remove and install cam pulley bolts, use the proper tools to secure the hexagonal part in front of camshaft.

**[Point 3] Remove & install timing belt cover back plate**

**Removal**

- Remove back plate bolt and detach back plate.

**Installation**

- Assemble canister tube with back plate and then install back plate.

**Back plate bolt tightening torque (kg-m): M6 0.64 ~ 0.85  
M8 1.6 ~ 2.1**

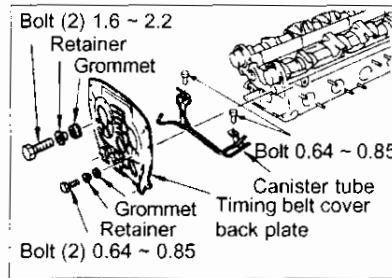

**[Point 4] Camshaft end play inspection**

- Set the dial gauge in front of camshaft as shown in the diagram. Read the dial gauge run-out width when the camshaft moves in front or rear direction.

**Standard value (mm): 0.030 ~ 0.080**

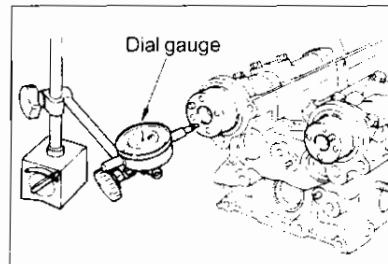

**[Point 5] Remove & install cam bracket**

**Removal (Exhaust and intake camshaft)**

- Place marks to indicate the bracket position and its direction before removing the cam bracket.
- Remove cam bracket bolts by loosening them gradually in several stages in reverse sequence shown in the figure.

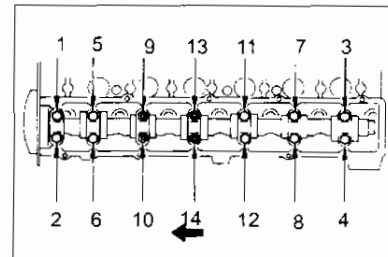

**Installation**

- Align the crank pulley timing indicator and the timing belt cover timing indicator (0°) so No. 1 cylinder is at compression T.D.C position. (This operation is not necessary when cylinder head is removed as single unit).
- Turn the camshaft so No. 1 cylinder is at compression T.D.C position. (Operation is easier if the camshaft is turned 60° before or after No. 1 cylinder T.D.C point when cylinder head is installed as single unit).
- Verify the position of No. 1 cylinder is at compression T.D.C by knock pin in front end of camshaft.

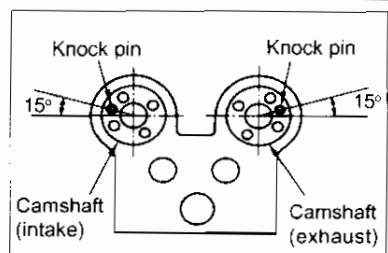
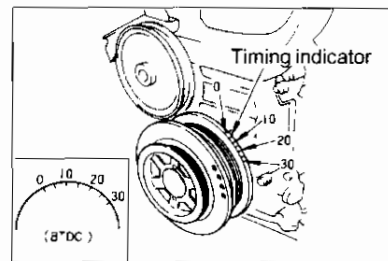



- To install camshaft, temporarily tighten No. 1 cam bracket and check that camshaft thrust section is positioned securely.
- Tighten cam shaft bolt 540° (1.5 turns) in the order shown in the figure on the previous page.

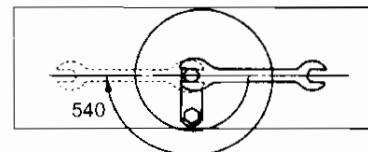

**Cam bracket tightening torque (kg-m): 0.92 ~ 1.2**

**Caution:**

- (1) Coat the cam journals and end of the cam shaft with engine oil before installation.
- (2) Do not rotate camshaft. (The valve and pistons may interfere).

**[Point 6] Valve clearance adjustment**

**No. 1 cylinder compression T.D.C point**

- Turn the camshafts (intake and exhaust) so No. 1 cylinder is at the compression T.D.C position.
- Check knock pin position of camshaft front end to verify No. 1 cylinder compression T.D.C position.

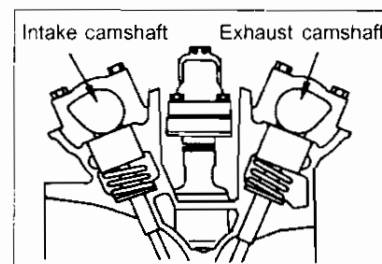

- No. 1 cylinder is at the compression stroke top dead centre when both the intake and exhaust side cams do not move the valve lifters.

← Valves which can be adjusted

ITEM	PART	VALVE CLEARANCE MEASUREMENT
INTAKE SIDE		Cylinder No. 1, 2, 4
EXHAUST SIDE		Cylinder No. 1, 3, 5

Firing order: 1 - 5 - 3 - 6 - 2 - 4

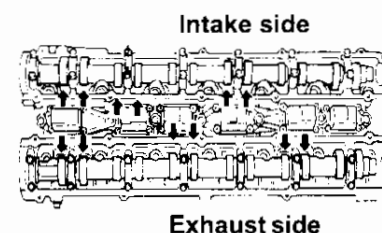

Intake side

Exhaust side

- Rotate the intake and exhaust camshaft 180°.
- No. 6 cylinder is at compression stroke top dead enter when both the intake and the exhaust side cams do not move the valve lifters.

← Valves which can be adjusted

ITEM	PART	VALVE CLEARANCE MEASUREMENT
INTAKE SIDE		Cylinder No. 3, 5, 6
EXHAUST SIDE		Cylinder No. 2, 4, 6

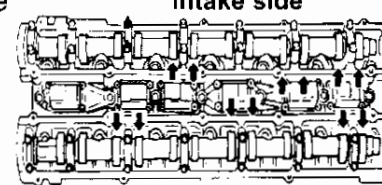

Intake side

Exhaust side

**Valve clearance specifications**

(20+/-5°C)

ITEM	PART	INTAKE	EXHAUST
Valve clearance (cold)	mm	0.45 <sup>+0.03</sup>	0.38 <sup>+0.03</sup>
(Reference value: warm)	mm	0.51 <sup>+0.03</sup>	0.44 <sup>+0.03</sup>

**Caution:**

Always inspect when the engine is cold.

**Reference: Compensation by room temperature**

Room temperature (°C)	0 +/- 5	10 +/- 5	20 +/- 5	30 +/- 5
Compensation value (mm)	+0.02	+0.01	0	-0.01

**Valve clearance measurement**

- Insert a 0.15 ~ 0.20 mm gauge (A) from spark plug side. Insert gauge (B) from opposite side. Select a gauge thickness that will reduce the clearance to 0 m.

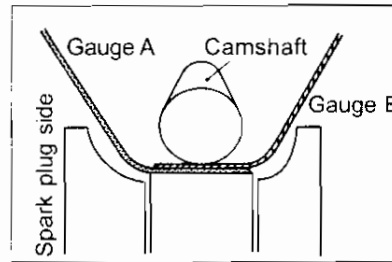

Note:

Do not use more than two gauges for (B).  
Use JIS 150A25 feeler gauge.

Valve clearance = Gauge (A) + Gauge (B)

Reasons for measurement using gauge (A) and (B) :

1. The valve clearance setting is larger compared to previous engines.
  2. Large gauges cannot be placed parallel to the measurement surface.
- Thick feeler gauge have high rigidity and cannot be bent easily, so the measurement will be incorrect.
  - The error factor increases if a number of thin gauges are layered and the measurement will be incorrect.

**Valve clearance adjustment**

- The valve clearance adjustment is performed by selecting a shim of suitable thickness.
- When the measurement valve clearance (t) is out of specification, measure the shim thickness (T) and replace it with a shim that will produce the standard clearance.

**1. Shim thickness calculation method**

Example:

When the intake valve clearance (t) is 0.50 mm:

$$0.50 (t) - 0.45 (\text{specified value}) = 0.05 \text{ mm}$$

- The valve clearance is 0.05 mm greater than the specified value.
- Use a shim 0.05 mm thicker than the current shim to reduce the valve clearance.

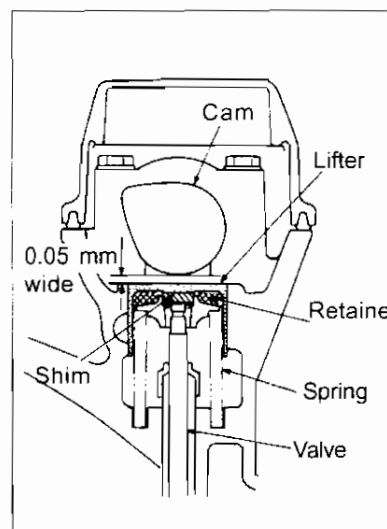

**2. Current shim thickness (T)**

- Measure the center of removed shim to determine the thickness of the current shim.

Caution:

Do not reuse the measured shims again.

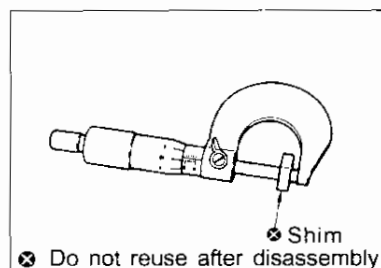

**3. Shim selection**

- Current shim thickness (T) is 2.40mm.  
2.40 (T) mm + 0.05 mm = 2.450
  - Select new shim with stamped mark [24.40] (T = 2.440 ~ 2.455).
- Select a shim within standard value range +/- 0.03 mm.

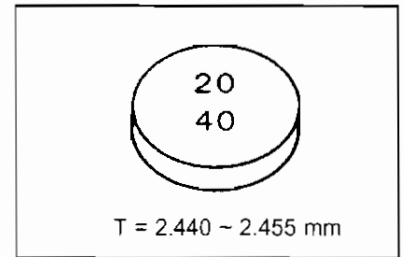

**4. Shim types and classification**

- There are 70 types of shims. Sizes range from 2.275 mm to 3.325 mm in 0.05 mm increments.

**[Point 7] Install camshaft front oil seal**

- Care must be taken not to scratch or make a burr in the oil seal. Use a socket smaller than the seal (41 mm) and drive it into same level as front surface of the oil seal retainer.
- Apply a coat of engine oil to the entire perimeter of oil seal lip.

Caution:

Do not scratch the oil seal and lip.

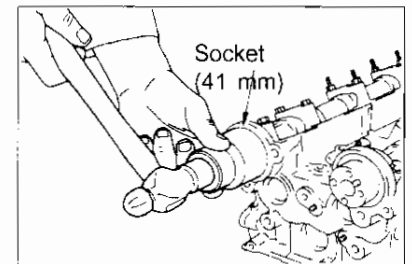

**[Point 8] Install camshaft rear rubber plug**

- Before installing the rubber plug, wipe off any oil, water etc. on the surface and clean thoroughly.
- When assembling the rubber plug, coat it with adhesive (three bond 1211) or equivalent.

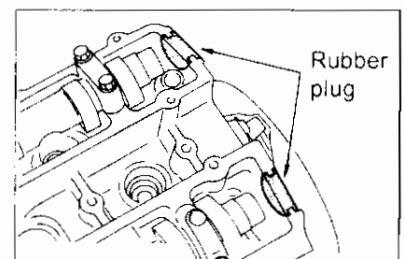

**[Point 9] Intake and exhaust camshaft classification**

- Intake and exhaust camshaft can be identified by identification point colour and presence of a spine gear for driving the crank angle sensor.

Camshaft	Identification paint	Spline gear
Intake camshaft	Pink	No
Exhaust camshaft	White	Yes

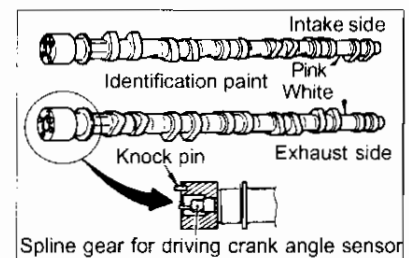

**[Point 10] Camshaft knock pin insertion**

- The protrusion distance is 5 mm for camshaft knock pin insertion.

**Knock pin protrusion distance (mm): 5**

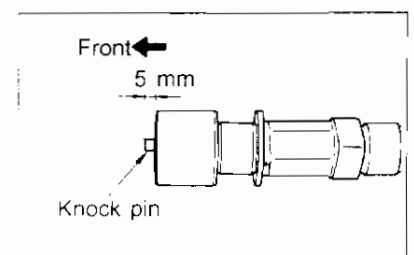

**[Point 11] Camshaft inspection**

**Cam height inspection**

- Use a micrometer to measure cam height.

	Intake side	Exhaust side
<b>Cam height standard value</b>	40.58	40.28
<b>Cam lift (reference)</b>	8.58	8.28

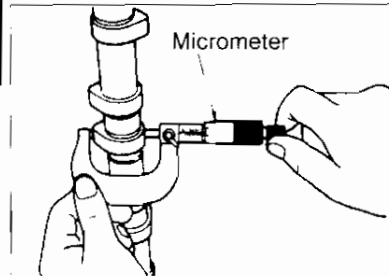

**Cam journal external diameter inspection**

- Use a micrometer to measure the external diameter of the camshaft journal.

	No. 1 ~ No. 7
<b>Standard value (mm)</b>	27.935 ~ 27.955

**[Point 12] Camshaft run-out inspection**

- Support both camshaft end journals (No. 1 and No. 7) by using V-blocks on the fixed surface.
- Avoid the oil groove in the centre of the No. 4 journal and position the dial gauge vertically.
- Rotate the camshaft by hand one rotation and read the movement width on the dial gauge.
- The run-out is equal to one-half of the movement width indicated on the dial gauge.

**Standard value (mm): 0.05**

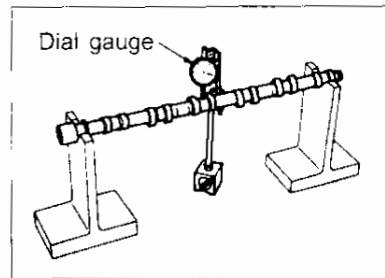

**[Point 13] Cylinder head cam bracket interior diameter inspection**

- Tighten the cam bracket to specified torque.

**Cam bracket bolt tightening torque (kg-m): 0.92 ~ 1.2**

- Use the bore gauge or inside micrometer to measure interior diameter.

	No. 1 ~ No. 7
<b>Standard value (mm)</b>	28.000 ~ 28.021

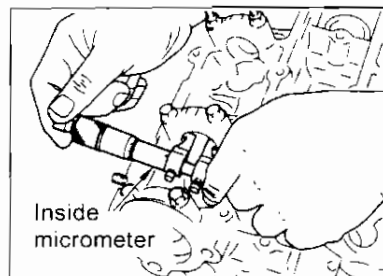

**[Point 14] Camshaft oil clearance inspection**

- The oil clearance can be calculated from the camshaft journal outside diameter and the bracket interior diameter measured in [Point 11] and [Point 13].

$$\text{(Oil clearance)} = \text{(Cam bracket interior diameter)} - \text{(Camshaft journal exterior diameter)}$$

	<b>No. 1 ~ No. 7</b>
<b>Standard value (mm)</b>	0.045 ~ 0.086

**[Point 15] Valve lifter inspection**

- Check the contact and sliding surfaces for wear or scratches. Replace if damaged.
- Use the micrometer to check the valve lifter outside diameter.

**Standard value (mm): 30.995 ~ 30.965**

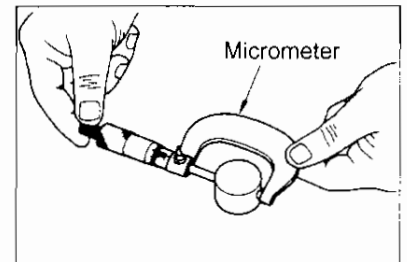

**[Point 16] Cylinder head lifter bore inspection**

- Check bore surface for wear or scratches.
- Use inside micrometer to measure valve lifter hole diameter.

**Standard value (mm): 31.0 ~ 31.020**

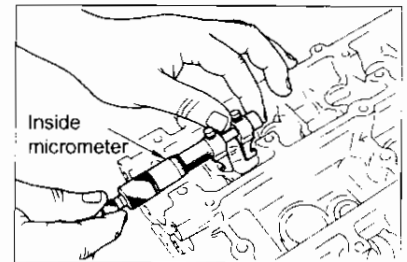

**[Point 17] Valve lifter-to-lifter hole clearance inspection**

- Check the clearance using values for the valve lifter outside diameter and valve lifter hole diameter measured in [Point 15] and [Point 16].

$$\text{(Clearance)} = \text{(Valve lifter hole diameter)} - \text{(Valve lifter outside diameter)}$$

**Standard value (mm): 0.025 ~ 0.065**

**[Point 18] Remove & install valve spring**

**When the cylinder head is removed from the vehicle:**

- Use the valve spring compressor to remove and install the valves.

**When the cylinder head is installed in the vehicle:**

- Use the valve spring compressor to install valve spring.

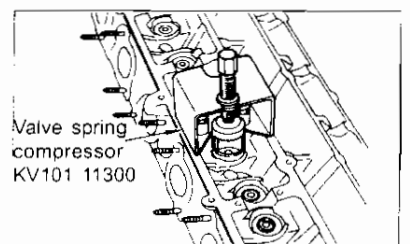
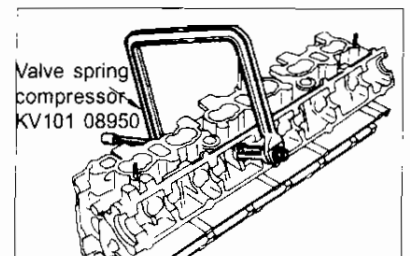

**[Point 19] Remove & install valve collet**

**Removal**

- Use tweezers to remove collet.

**Installation**

- Apply a small coating of petroleum jelly to the internal surface of the collet.
- Use a magnet screwdriver.
  1. Upper collet installation
    - Attach collet to the lower side of the magnetic screwdriver blade and install in the valve stem.
  2. Lower collet installation
    - Attach the collet to upper side of the magnetic screwdriver blade and install in the valve stem.

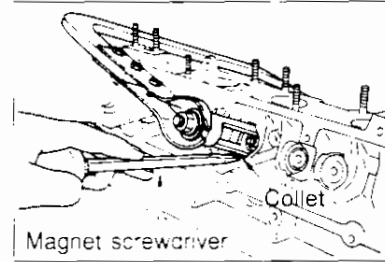
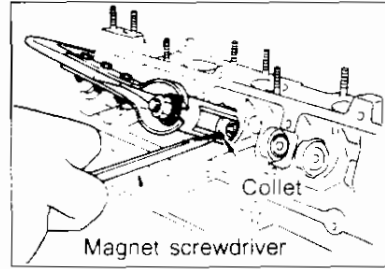

**[Point 20] Valve spring inspection**

**Free length and pressure load inspection**

- Use the valve spring tester to carry out the inspection.

	Standard value	Limit value
Free length (mm)	46.54	-
Installation load (kg)	24.0	22.5
Identification colour	White	-

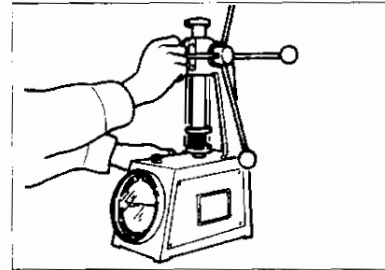

**Caution:**

Installation load is the force required to compress the spring length to 35 mm.

**Perpendicular inspection**

- Place a try square by the spring so it contacts spring. Turn the spring and measure the maximum clearance between upper spring surface and the right angle to determine the out-of-square distance.

**Limit (mm): 1.8**

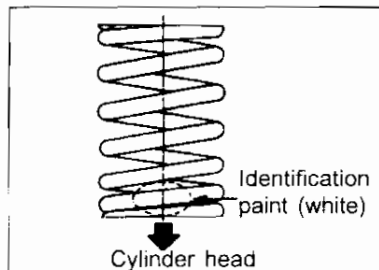
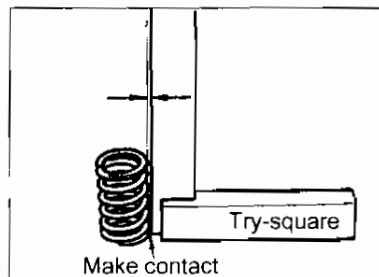

**[Point 21] Install valve spring**

- Install uneven pitch type spring with narrow end towards cylinder head (identification colour side).

**[Point 22] Valve guide clearance inspection**

- Protrude the valve approximately 15 mm towards the combustion chamber and measure the valve deflection by swinging it in direction parallel to the dial gauge.
- The clearance is equal to half of the dial gauge reading.

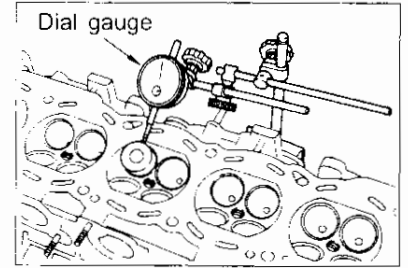

	Intake	Exhaust
Limit (mm)	0.1	0.1

- If clearance exceeds limit, verify the valve stem diameter and replace the valve or valve guide.

**[Point 23] Valve inspection  
Outside diameter measurement**

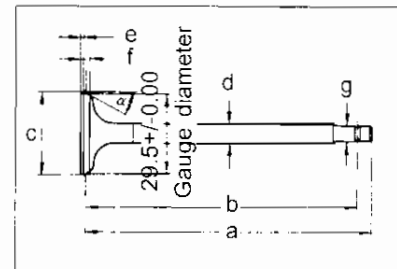
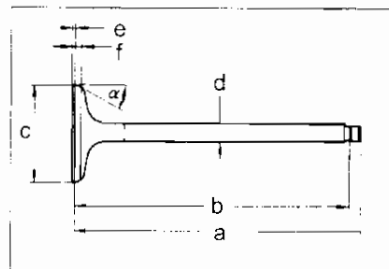

Valve	a	b	c	d	e	f	g	$\alpha$
Intake	100.98 $\pm$ 0.1	97.45 $\pm$ 0.15	34.5 $^{+0.2}_0$	6.0 $^{-0.020}_{-0.035}$	1.3	2.6 $^{+0.3}_0$	-	45° 30'
Exhaust	99.98 $\pm$ 0.1	95.48 $\pm$ 0.15	30.0 $^{+0.2}_0$	7.0 $^{-0.080}_{-0.095}$	(1.2)	2.9 $^{+0.3}_0$	6.0 $^{-0.020}_{-0.055}$	45° 30' $\pm$ 15'

Be especially careful in handling and disposal of valves as the exhaust valves are fitted with metallic sodium.

**[Point 24] Remove & install valve oil seal  
Removal**

- Use valve oil seal puller to remove the valve oil seal.

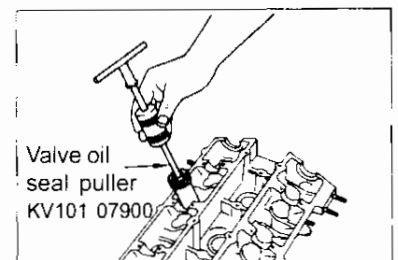

**Installation**

- Use valve oil seal drift to install the valve oil seal.

**Drift** KV101 07501

**Drift attachment** KV101 14800

Caution:

Coat inside of the valve seal with engine oil before installation.

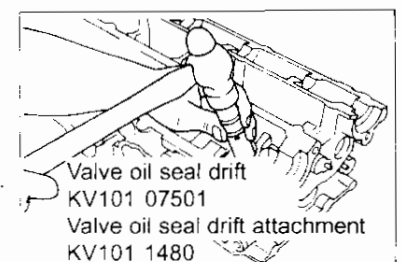

- Install valve oil seal as shown.

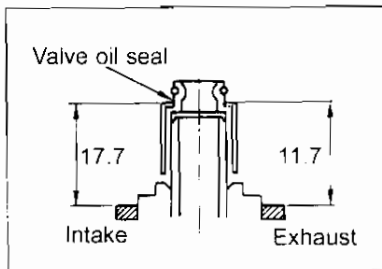

**[Point 25] Remove & install valve guide**

**Removal**

- Use valve guide drift and tap it from combustion chamber side to remove.

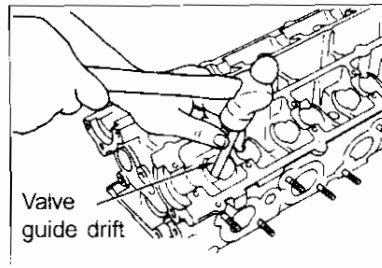

**Installation**

- Ream the cylinder head guide hole using the valve guide reamer at normal temperature (when using 0.5 mm over size service part).

<b>Rectified standard value (mm)</b>	<b>Intake side</b>	10.46 ~ 10.478
	<b>Exhaust side</b>	11.46 ~ 11.478

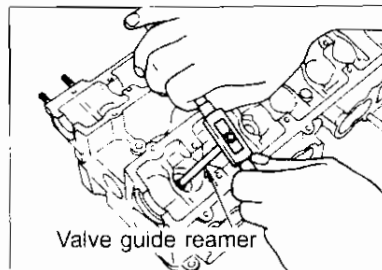

- Heat the cylinder head in an oil bath to approximately 150 to 160°C and use a valve guide drift or press-fit tool to press valve guide from camshaft side.

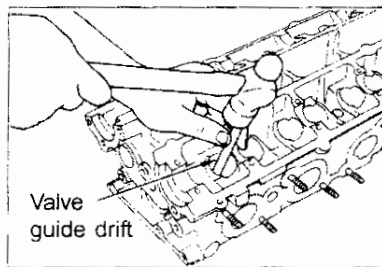

- The press-fit dimensions are shown in the figure on right.

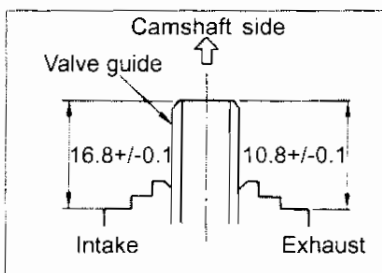

- Ream inside of inserted valve guide with the valve guide reamer.

<b>Finished internal diameter standard value (mm)</b>	<b>Intake side</b>	6.000 ~ 6.018
	<b>Exhaust side</b>	7.000 ~ 7.018

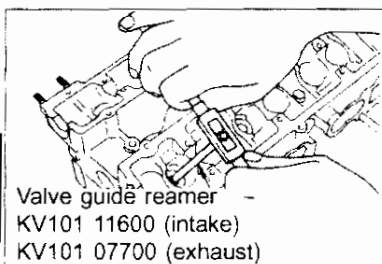



**[Point 26] Valve seat**

**Inspection**

- Inspect the condition of contacting surface of the valve seat and the valve.
- Replace the valve seat or the valve if contacting surface is too large or improper, or grind both surfaces and lap with abrasive compound.

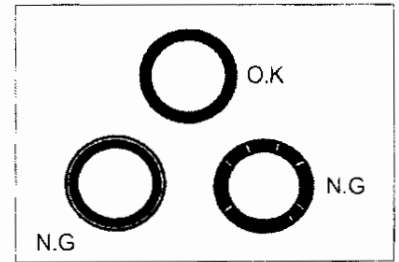

**Adjustments**

- When surfacing valve seat due to poor contact, inspect the valve guide clearance and valve step hole clearance.
- Use the valve seat cutter or the valve seat grinder and finish to standard value.

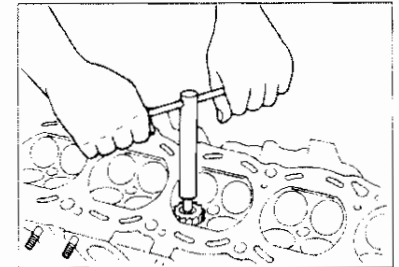

**Caution:**

When using valve seat cutter, press firmly and cut evenly with both hands to produce uniform cutting surface.

**Removal**

- Minimize the valve seat thickness by cutting it, then remove.

**Installation**

- (1) Drive the valve seat into cylinder head using the valve seat drifter as shown.

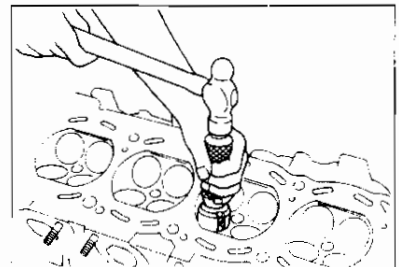

- (2) When not using the valve seat drifter:

- Cool the valve seat for approx. 5 minutes using dry-ice.
- Heat the cylinder head to approx. 80°C.
- Inject the valve seat into the cylinder head.

**Caution:**

Do not touch cooled valve seat with bare hands.

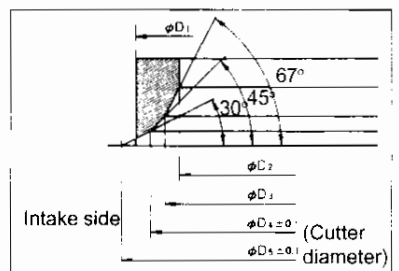

- Exhaust valve seats are available in 0.5 mm oversize. When using oversize valve seats, cut and grind the seating recess in cylinder to fix valve seats.

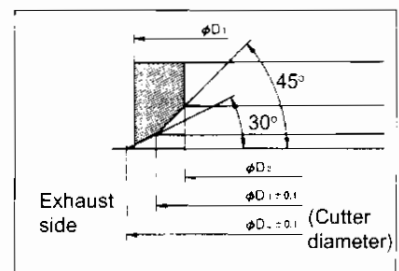

Item		Cylinder head finishing	Valve seat					
Valve oversize		d	phi D <sub>1</sub>	phi D <sub>2</sub>	phi D <sub>3</sub>	phi D <sub>4</sub>	phi D <sub>5</sub>	H
Intake	Standard	36 <sup>+0.016</sup> / <sub>0</sub>	36 <sup>+0.113</sup> / <sub>0.097</sub>	30 <sup>+/-0.15</sup>	32	34.3	37.5	6.6 <sup>0</sup> / <sub>-0.1</sub>
	0.5	36.5 <sup>+0.016</sup> / <sub>0</sub>	36.5 <sup>+0.113</sup> / <sub>0.097</sub>	30 <sup>+/-0.15</sup>	32	34.3	-	5.8 <sup>+/-0.05</sup>
Exhaust	Standard	32 <sup>+0.016</sup> / <sub>0</sub>	32 <sup>+0.096</sup> / <sub>0.080</sub>	25 <sup>+/-0.15</sup>	29.6	32.5	-	6.6 <sup>0</sup> / <sub>-0.1</sub>
	0.5	32.5 <sup>+0.016</sup> / <sub>0</sub>	32.5 <sup>+0.096</sup> / <sub>0.080</sub>	25 <sup>+/-0.15</sup>	29.6	-	-	5.8 <sup>+/-0.05</sup>

**[Point 27] Cylinder head inspection**

- Clean and remove oil, gasket, sealing compound, carbon and other foreign matter.
- Measure the lower surface of the cylinder head in six directions to check for any distortion.  
**Limit (mm): 0.2**
- When the distortion is just over the limit, resurface the cylinder head.
- If the distortion exceeds excessively over the limit, replace the cylinder head.

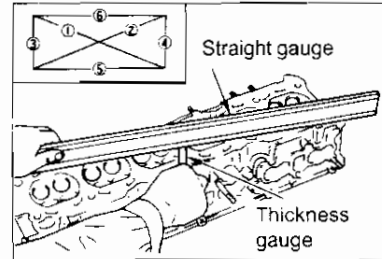
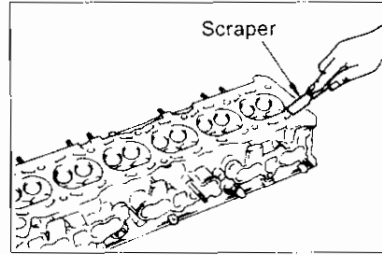

**10-13 WATER PUMP REMOVAL AND INSTALLATION**

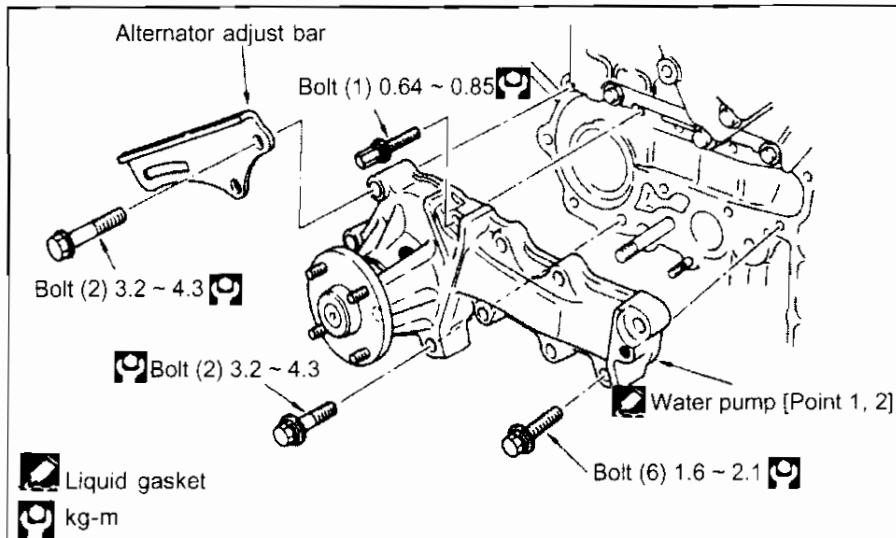

**Additional work required:**

- Drain and refill cooling water
- Remove and install:
  - Cooling fan, water pump relay
  - Alternator adjustment bolt
  - Timing belt cover, timing belt

**[Point 1] Remove & install water pump**  
**Remove**

- Care must be taken not to get coolant on the timing belt. Wipe it off immediately if any water does spill.
- Remove the water pump bolts in the reverse order shown.

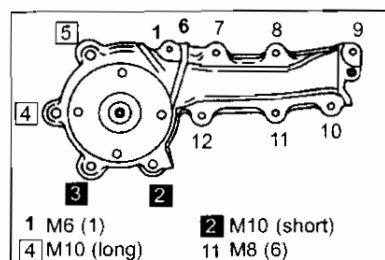

### Installation

- Install the bolts in the numbered sequence shown.

Installation location	Bolt size	No. of bolts	Tightening torque (kg-m)
1	M6	1	0.64 ~ 0.85
7, 8, 9, 10, 11, 12	M8	6	1.6 ~ 2.1
2, 3, 4, 5	M10	4	3.2 ~ 4.3

### Removal and cleaning

- Insert stubby screwdrivers in the bolt holes and move it up and down to remove the water pump.

#### Caution:

Take care not to damage the screws in cylinder block side.

- Use a scraper to remove all liquid gasket from the surface.

#### Caution:

Also remove the liquid gasket remaining in grooves.

- Wipe the installation surface with white gasoline.

### Installation

- Cut the nozzle end of liquid gasket tube (KP510 00150) as shown in the figure and use tube presser for application.

- Apply continuous bead of liquid gasket (KP510 00150) to water pump sealing surface.

#### Caution:

Be sure liquid gasket is 2.0 to 3.0 mm wide.

Installation must be carried out within 5 minutes after liquid gasket application.

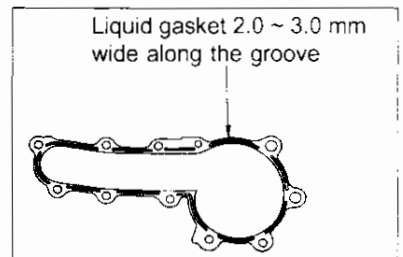
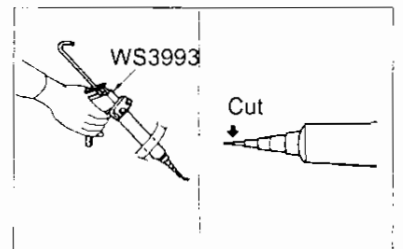
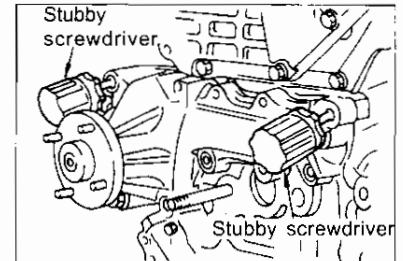

### [Point 2] Water pump inspection

- Rotate the water pump by hand and check for abnormal sound and smooth operation.
- There must be no traces of water leaks.

## 10-14 THERMOSTAT REMOVAL &amp; INSTALLATION

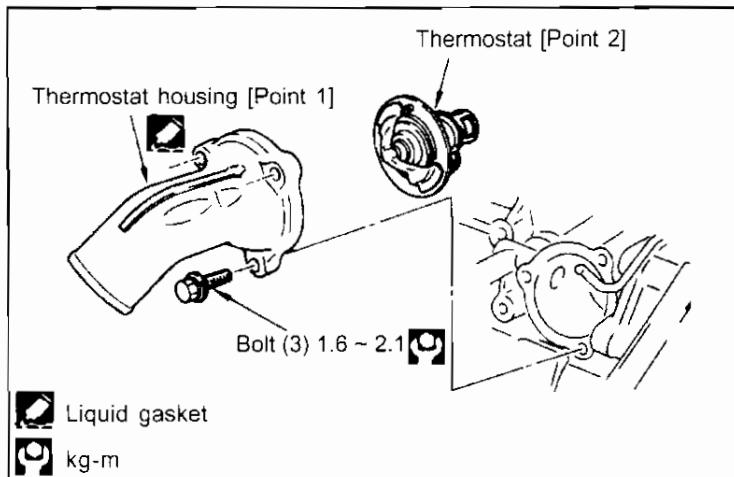
**Additional work required:**

- Disconnect and connect water inlet hose
- Drain and refill cooling water

**Caution:**

Loosen engine drain plug to remove cooling water from the cylinder block.

**[Point 1] Remove & install thermostat housing**  
**Removal and cleaning**

- Insert the screwdriver handle into thermostat housing and move it up and down lightly to remove the housing.
- Use a scraper to remove the liquid gasket.

**Caution:**

Make sure to remove liquid gasket in grooves.

- Wipe off the surface with white gasoline.

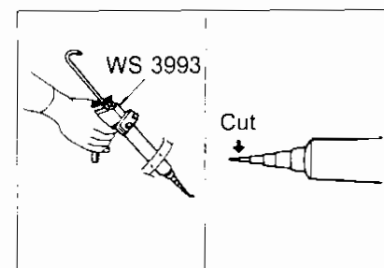
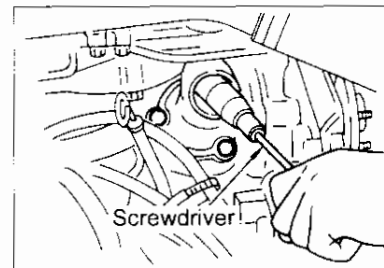
**Installation**

- Cut nozzle end of liquid gasket (KP510 00150) tube as shown.

- Apply a continuous bead of liquid gasket to sealing surface using the tube presser. Install the housing within 5 minutes after coating liquid gasket.

2.0 ~ 3.0 mm wide to center of flat mating surface and inner seating surfaces of bolt holes.

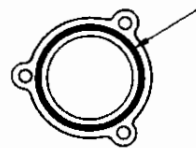

**[Point 2] Install thermostat**

- 'Top' mark (jiggle valve) must face up when thermostat is inserted in housing.

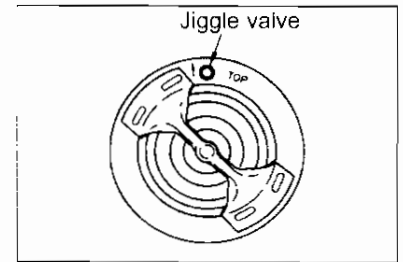

**[Point 3] Thermostat inspection**

- Check the valve opening temperature and maximum valve lift.
- Hang the thermostat by string in valve and submerge in heated water in double walled container and stir water while heating it up.
- The opening temperature is the temperature when the valve opens and thermostat falls from string.

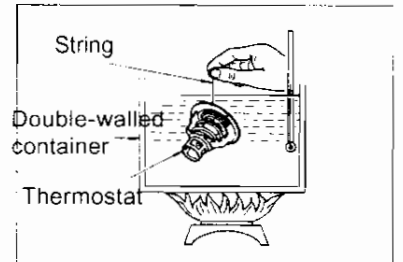

	Standard, cold climate
Valve opening temperature (°C)	76.5
Max. valve lift mm/ °C	10 / 90

**10-15 INSTALL & REMOVE OIL COOLER, OIL FILTER**

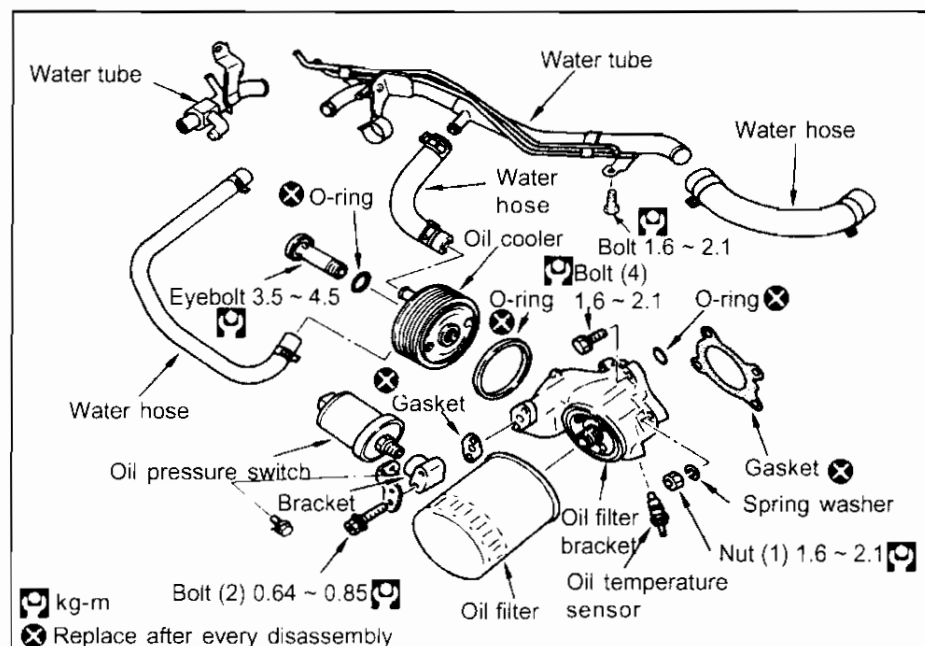

**Additional work required:**

- Disconnect and connect switch harness connectors
- Drain and refill cooling water

**Caution:**

Loosen engine drain plug to remove cooling water from cylinder block. (If water is only drained from the radiator drain cock, the cylinder block will not drain completely).

**[Point 1] Remove & install oil filter**

**Removal**

1. Remove the oil level gauge.
2. Remove turbocharged pressure control vacuum hose clamp and move the vacuum hose out of the way.
3. Move main harness clamp out of the way. (If the oil filter come loose, remove the oil filter using the filter wrench).
4. Use oil filter wrench to remove oil filter.

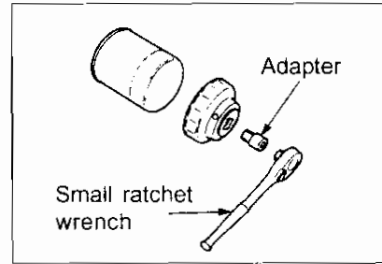

**Installation**

- Wipe off dust etc. from the oil filter mounting bracket surface before installing new oil filter. Apply a thin coat of engine oil to oil filter O-ring before installation.
- Screw the oil filter on bracket by hand until a slight resistance is felt, then tighten an additional 2/3 turns using the oil filter wrench. Start the engine and check for oil leaks.

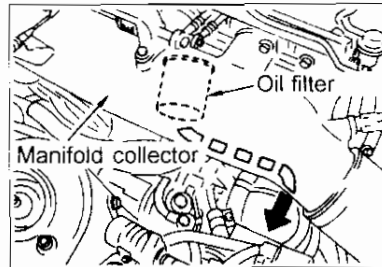

**Removal**

- Face lower part of oil filter down and move out in the direction of the arrow in figure right. Remove through aperture behind manifold collector.

**10-16 OIL PAN, OIL PUMP & OIL STRAINER**

**(1) Remove & install oil pan, oil pump & oil strainer**

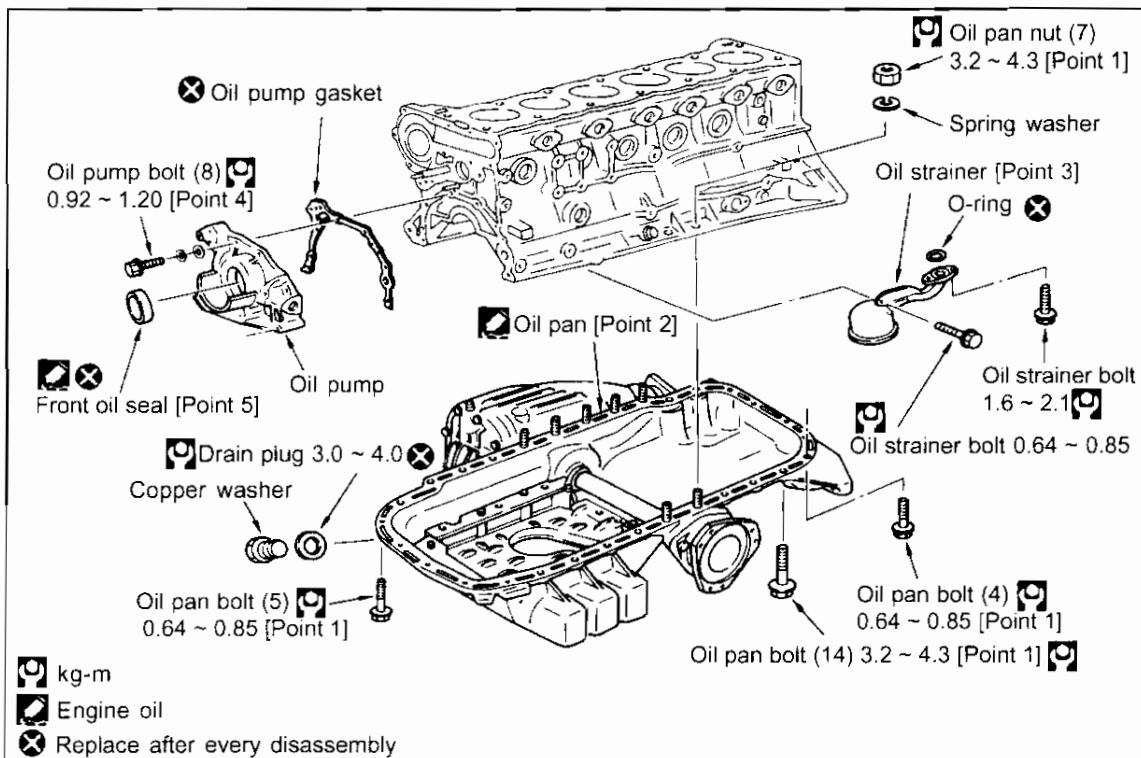

**Additional work required:**

- Engine ASSY
- Drain and refill engine oil

**[Point 1] Remove & install oil pan bolts & nuts**

**Removal**

- Remove bolts and nuts in reverse order of installation sequence shown in the figure on right.

**Installation**

- Install the nuts and bolts in the order of sequence shown in the figure on right.

**Caution:**

Make sure there are no dirt, dust or other foreign objects on oil installation surface.

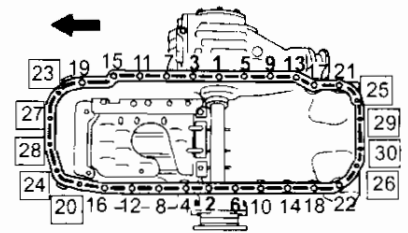

Installation position	Bolt / Nut size	No. of bolts / nuts	Tightening torque (kg-m)
20, 23, 24, 25, 26 27, 28, 29, 30	M6 (Bolt)	9	0.64 ~ 0.85
4, 7, 8, 10, 11, 12, 14, 15, 16, 17, 18, 19, 21, 22	M10 (Bolt)	14	3.2 ~ 4.3
1, 2, 3, 5, 6, 9, 13	M10 (Nut)	7	3.2 ~ 4.3

**[Point 2] Remove & install oil pan**

**Removal & cleaning**

- Use a seal cutter to remove and clean the oil pan.
- Use a scraper to remove liquid gasket from mating surface.

**Caution:**

Use a scraper to remove all liquid gasket and seal material on the cylinder block and oil pan flange groove. Remove all gasket and other foreign objects in the oil pan.

- Clean all contact surfaces with white gasoline.

**Installation**

- Cut off the nozzle tip of liquid gasket (KP510 00510) at point shown in the figure on right.

- Apply liquid gasket to inner sealing surfaces on the oil pan as shown in the figure on right.
- Installation must be performed within 5 minutes.

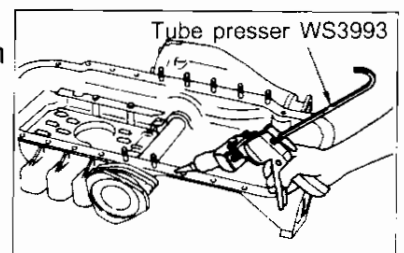
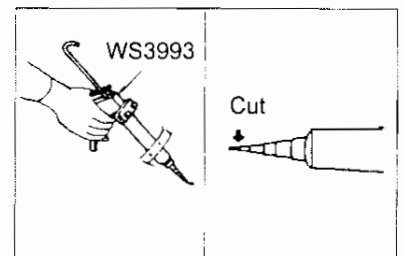
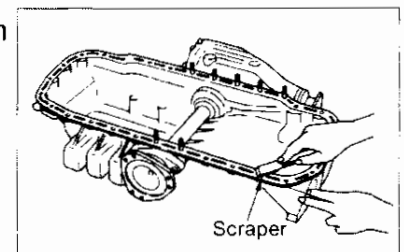
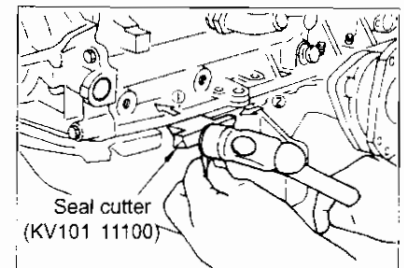

RB26DETT ENGINE

- Apply liquid gasket (KP510 00150) to areas 7 mm inside from center of the oil pan bolt holes.

**Caution:**

- (1) Make sure the liquid gasket is applied 4.0 mm wide.
- (2) Wait at least 30 minutes before refilling the engine oil and engine coolant after installation.

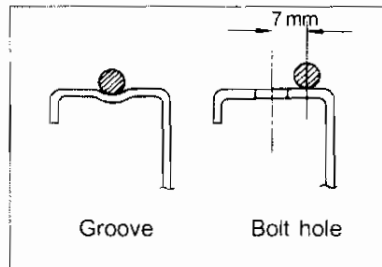

**[Point 3] Install oil strainer**

- Make sure the O-ring is installed securely in groove when installing the oil strainer.

**Tightening torque (kg-m):** 1.6 ~ 2.1 (M8)  
0.64 ~ 0.85 (M6)

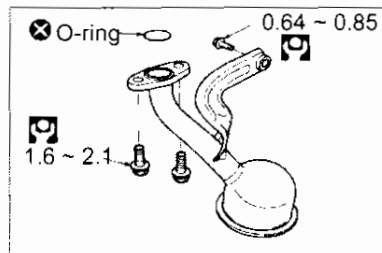

**[Point 4] Oil pump bolt**

- There are 4 types of bolts. Make sure to use the correct bolts when they are installed.

Installation position	Length below head (mm)	No. of bolts	Tightening torque (kg-m)
1	20	4	0.92 ~ 1.2
2	35	2	0.92 ~ 1.2
3	45	1	0.92 ~ 1.2
4	55	1	0.92 ~ 1.2

**[Point 5] Remove & install front oil seal**

**Removal**

- Use a tool such as screwdriver to remove front oil seal from the front cover.

**Installation**

- Care must be taken not to scratch or damage the oil seal retainer. Use oil seal drift and insert it at same level as front surface of the oil pump housing.
- Apply engine oil or chassis grease to area around the oil seal lip.

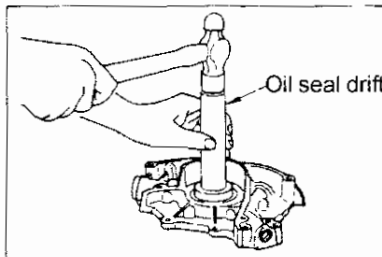
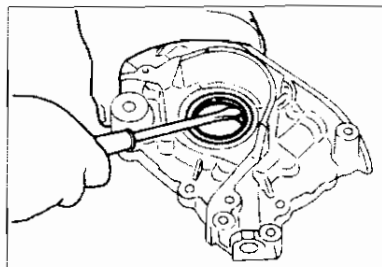

**[Point 6] Oil leak & oil pressure inspection**

- After installation warm up the engine and check for any oil leaks and the oil pressure.
- Remove oil pressure switch and attach oil pressure gauge when measuring oil pressure.

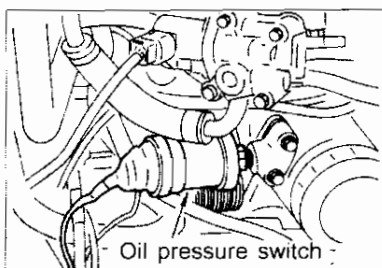

Engine rev (rpm)	Idling	2000	6000
Exhaust pressure (kg / cm <sup>2</sup> )	Approx. 1.5	Approx. 3	Approx. 4.6



## RB26DETT ENGINE

## (2) Oil pan disassembly &amp; assembly

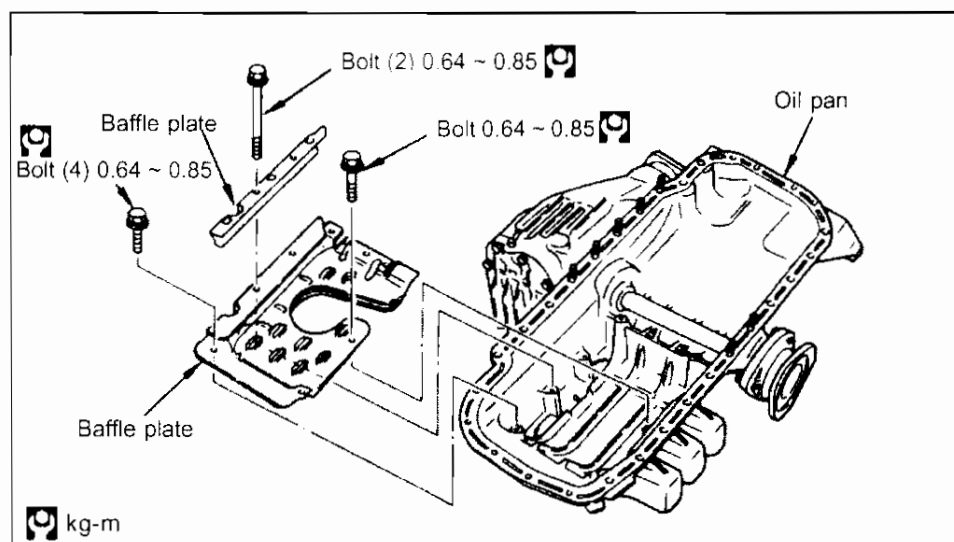

## (3) Oil pump disassembly &amp; assembly

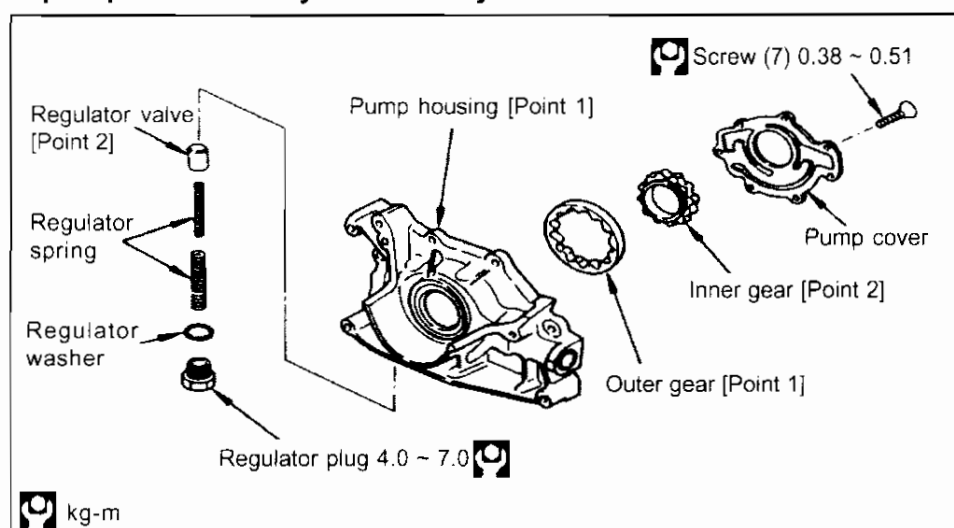
**[Point 1] Oil pump inspection**

- Check inner gear, outer gear and housing for any scratches or wear.
- Use thickness gauge to measure the following clearances:

	Measurement position	Standard value (mm)
1	Outer gear and housing clearance	0.114 ~ 0.2
2	Outer gear and inner gear clearance	Below 0.180
3	Inner gear and housing side clearance	0.05 ~ 0.07
4	Outer gear and housing side clearance	0.05 ~ 0.11
5	Inner gear and housing flange clearance	0.045 ~ 0.091

Measurement position 5 is obtained by subtracting the housing flange outside diameter from the inner gear inside diameter.

RB26DETT ENGINE

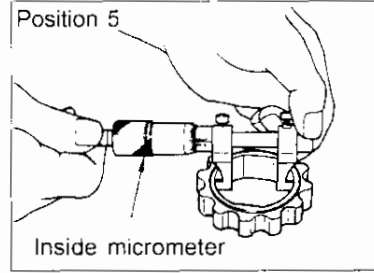
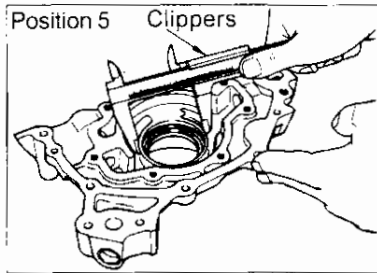
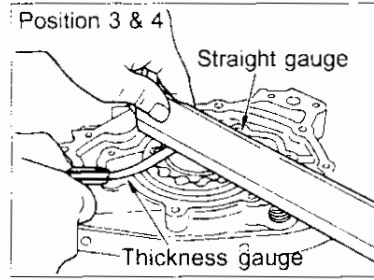
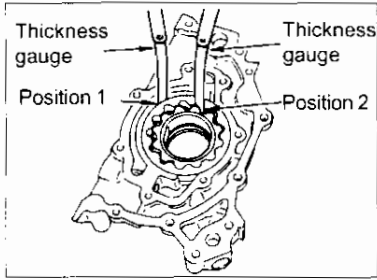

**[Point 2] Regulator inspection**

- Check oil pressure regulator valve sliding surface and the spring for any wear and damage.

**Valve and valve hole clearance (mm): 0.04 ~ 0.097**

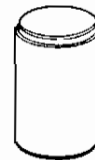

**[Point 3] Install inner gear**

- Care must be taken to install the inner gear in a specific direction.
- Face the side with the groove to the cover side.

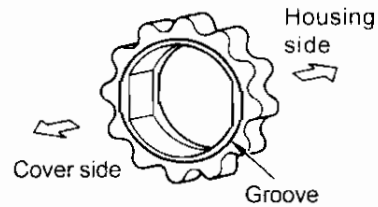

## 10-1 COLLECTOR ASSY

### (1) Collector ASSY removal & installation

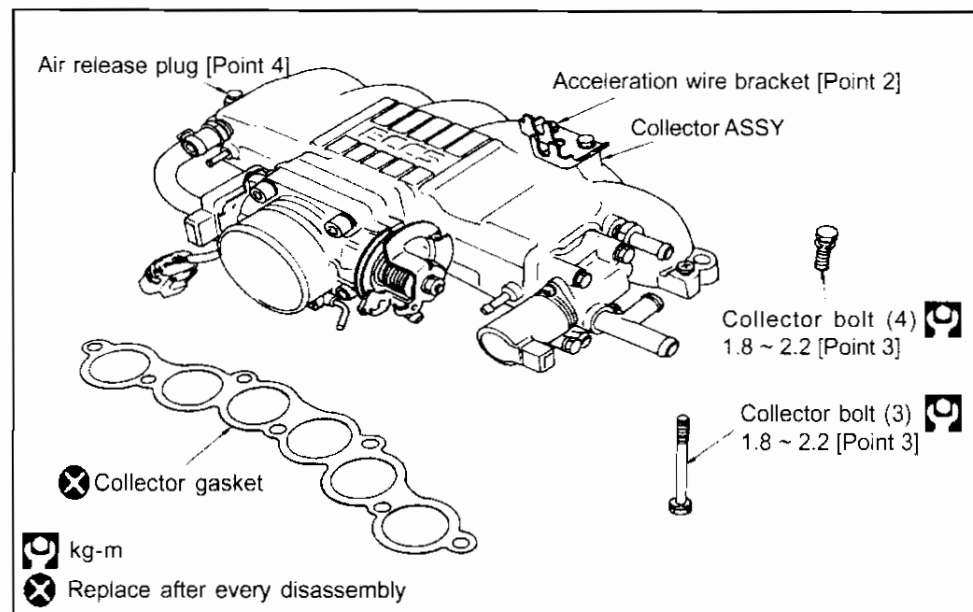

#### Additional work required:

- Release fuel pressure in the fuel lines [Point 1]
- Drain & refill cooling water [Point 4]
- Acceleration wire [Point 2]
- Air duct
- Harness connector
- All hoses

#### [Point 1] Release fuel pressure

- Start the engine.
- After starting the engine remove the fuel pump fuse and wait until the engine stops. Crank engine two or three times to consume fuel remaining in the fuel pipes.
- If the vehicle doesn't start, remove the fuel pump fuse and crank the engine four to five times to consume fuel remaining in the fuel pipes.

#### Caution:

The battery may become weak easily, use booster cable to connect to another battery if necessary.

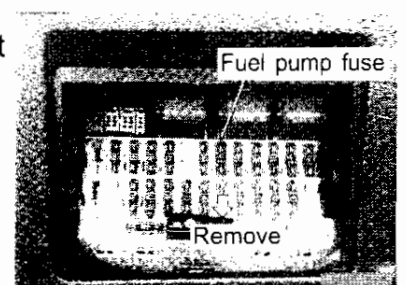

#### [Point 3] Accelerator wire adjustment

- Loosen lock nut to provide adequate slack for the accelerator wire and pull outer case in the direction of the accelerator.
- Return the lock nut 1.0 to 1.5 turns from the position the throttle drum starts moving (when there is no play in cable) and tighten.

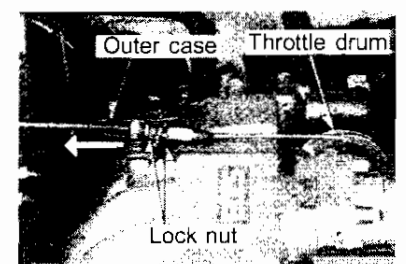

**Tightening torque (kg-m): 0.8 ~ 1.0**

**[Point 3] Remove & install collector bolts**

**Removal**

- Remove the bolts in the reverse order of the figure on right.

**Installation**

- Install the bolts in the order shown in the figure on right uniformly in two to three stages.

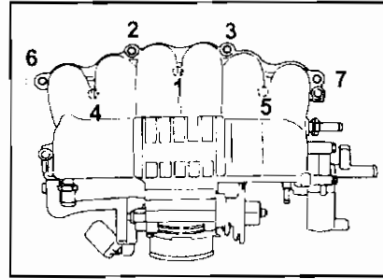

**[Point 4] Air release plug**

- For more information refer to the section on cooling system later on in the manual.
- Carry out the operation when engine is cool.

**Caution:**

Do not remove the air release plug when the engine is hot.

- Remove the air release plug to release the air within the engine completely when refilling cooling water.

**Caution:**

Care must be taken not to over tighten the air release plug bolt.

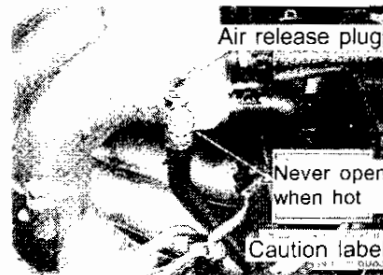

**Tightening torque (kg-m): 0.7 ~ 0.8**

**(2) Collector ASSY disassembly & assembly**

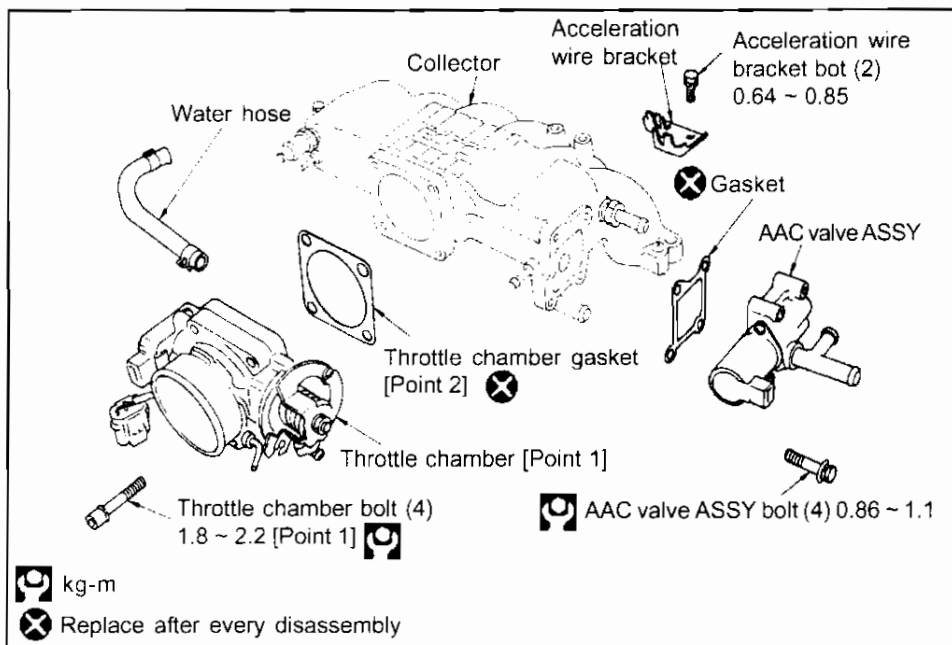

**Additional work required:**

- Remove and install collector ASSY

**[Point 1] Remove & install throttle chamber bolt**

**Removal**

- Remove the bolts in the reverse order of the figure on the right.

**Installation**

- Install the bolts in the order shown in the figure on right uniformly in two stages.

**Tightening torque (kg-m):**      **First stage**    **0.9 ~ 1.1**  
    **Second stage**    **1.8 ~ 2.2**

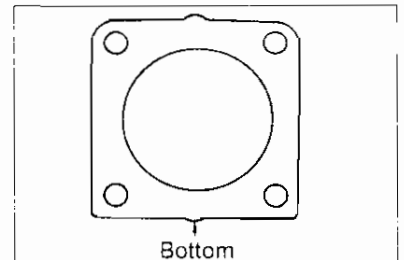
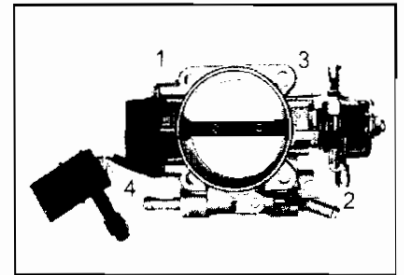

**[Point 2] Throttle chamber gasket**

- Check the installation direction before installing the throttle chamber gasket.

**10-2 INTAKE MANIFOLD ASSY**  
**(1) Remove & install intake manifold ASSY**

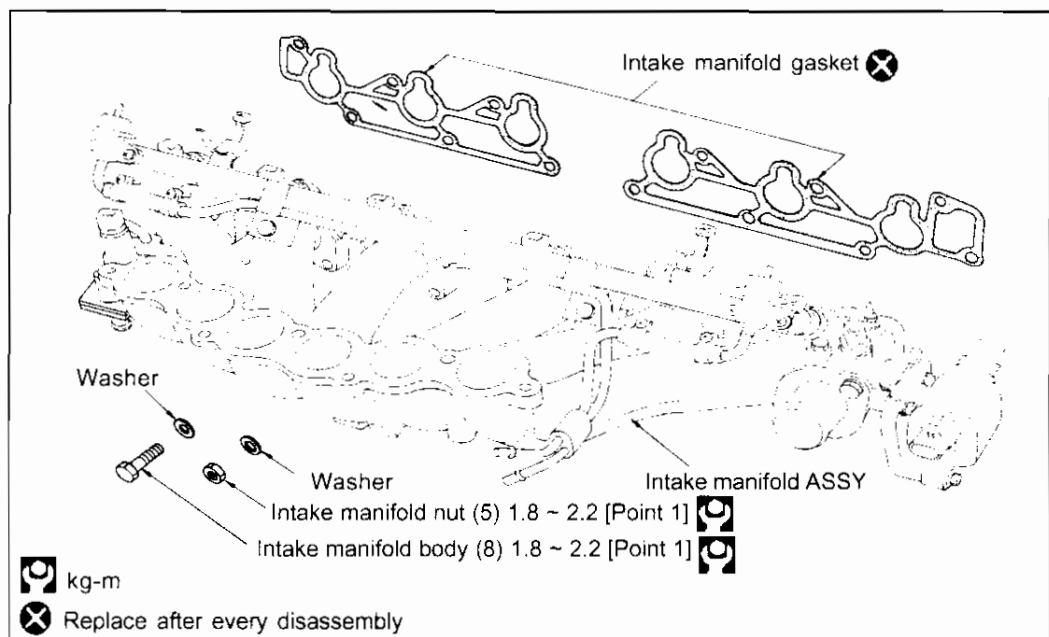

**Additional work required:**

- Remove and install collector ASSY
- ECCS harness connector and all hoses

**[Point 1] Remove & install intake manifold ASSY bolts and nuts**

**Removal**

- Remove the bolts and nuts in the reverse order of the figure on right.

**Installation**

- Install the bolts and nuts in the order shown in the figure on right.

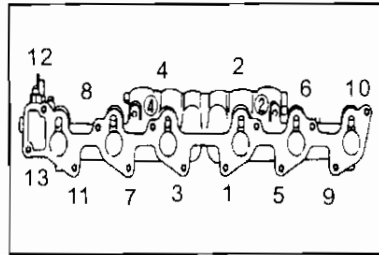

**(2) Intake manifold ASSY disassembly & assembly**

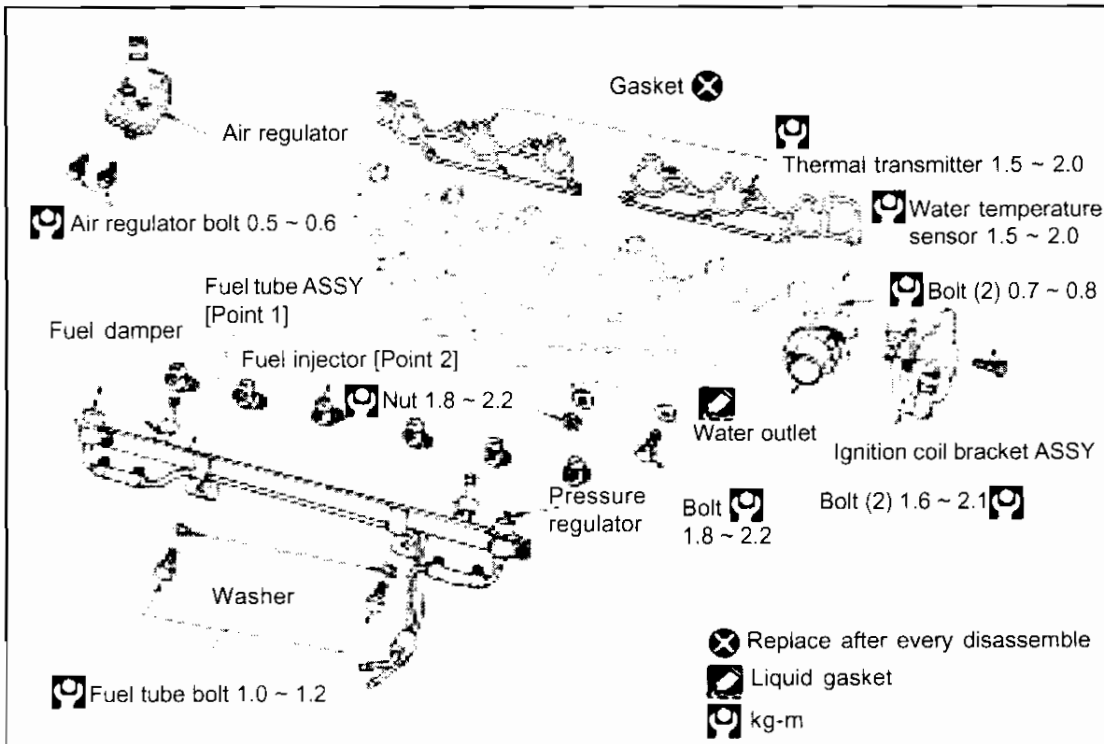

**Additional work required:**

- Remove and install intake manifold ASSY

**[Point 1] Fuel tube ASSY**

- Replace the O-ring to new ones when removing and installing the pressure regulator and the fuel damper.

**Caution:**

Care must be taken not to scratch or damage the fuel tube O-ring area when installing the pressure regulator and the fuel damper.

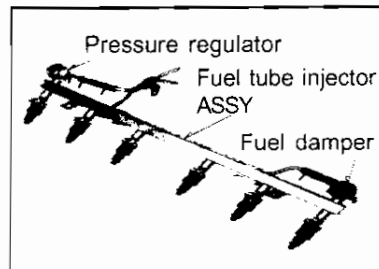

**[Point 2] O-ring (for fuel injector, pressure regulator and fuel damper)****Precautions when handling**

- Coat the O-ring with engine oil (7.5W -30 or equivalent) or silicon oil (NUC silicon L45 or equivalent), but do not apply solvent as this may remove oil coating.
- Avoid using dirty O-rings and do not allow dirt, dust or foreign objects to adhere to O-rings or other equipment surfaces.
- Care must be taken not to scratch, twist or stretch them by tools or operator's fingernails when installing O-rings.
- Do not decenter or rotate the fuel injectors and the pressure regulator when inserting them into the fuel tube.
- Do not store O-rings in location subject to ozone, high temperature or in direct sunlight.

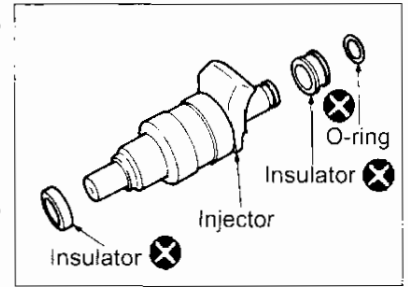
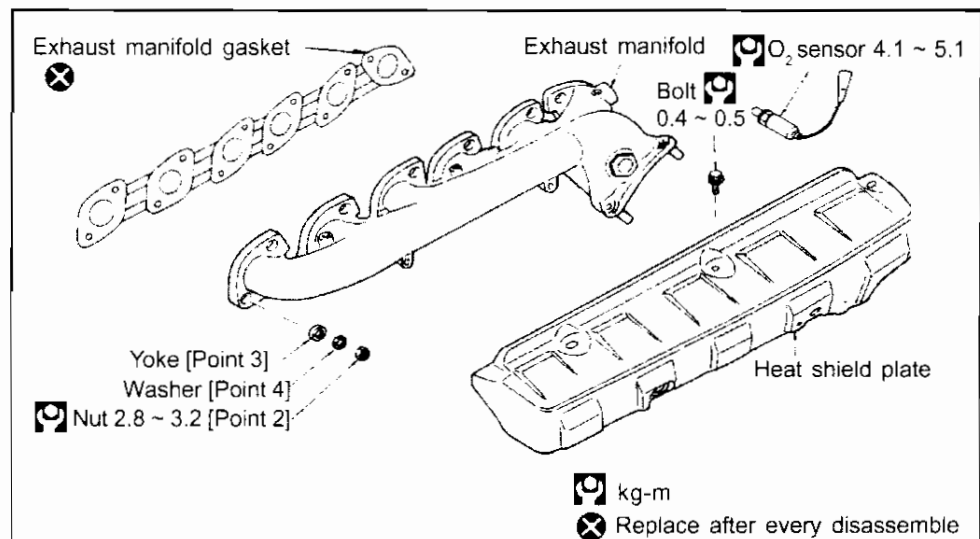
**10-3 REMOVE & INSTALL EXHAUST MANIFOLD ASSY****Additional work required:**

- Under cover
- Assemble and disassemble exhaust front tube
- O<sub>2</sub> sensor connector

**[Point 1] Gas leak inspection**

- After removing the exhaust manifold, make sure there are no traces of gas leaks from any parts.
- After the installation, crank the engine and check for any gas leaks.

**[Point 2] Remove and install exhaust manifold nuts**

**Removal**

- Removal is the reverse of installation sequence shown in the diagram on right.

**Installation**

- The installation sequence is shown in the diagram on right.

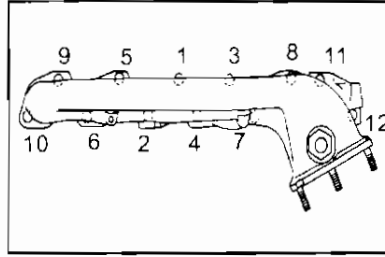

**[Point 3] Yoke**

- Make sure not to make mistake between No. 3 and No. 4 yoke as configurations are different.

Item	D (mm)
No.3 & No.4 port	22
Other than those above	24

**[Point 4] Install washer**

- Make sure the washer is facing the correct way when installing.

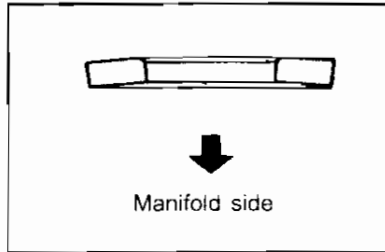

**10-4 REMOVE & INSTALL LOCKER COVER**

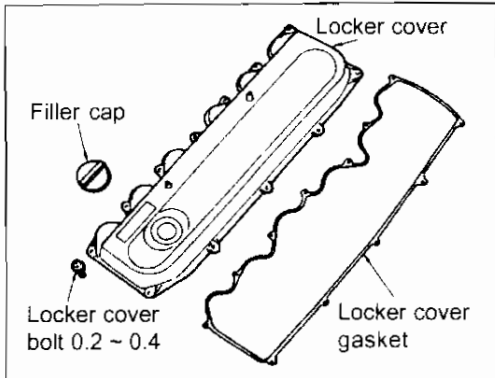

**Additional work required:**

- Air duct
- Air duct bracket
- Blowby hose

**[Point 1] Remove & install locker cover bolts**

**Removal**

- Removal is the reverse of installation sequence shown in the diagram on right.

**Installation**

- The installation sequence is shown in the diagram on right.

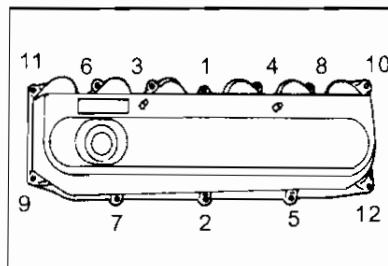



10-5 TIMING BELT REMOVAL & INSTALLATION

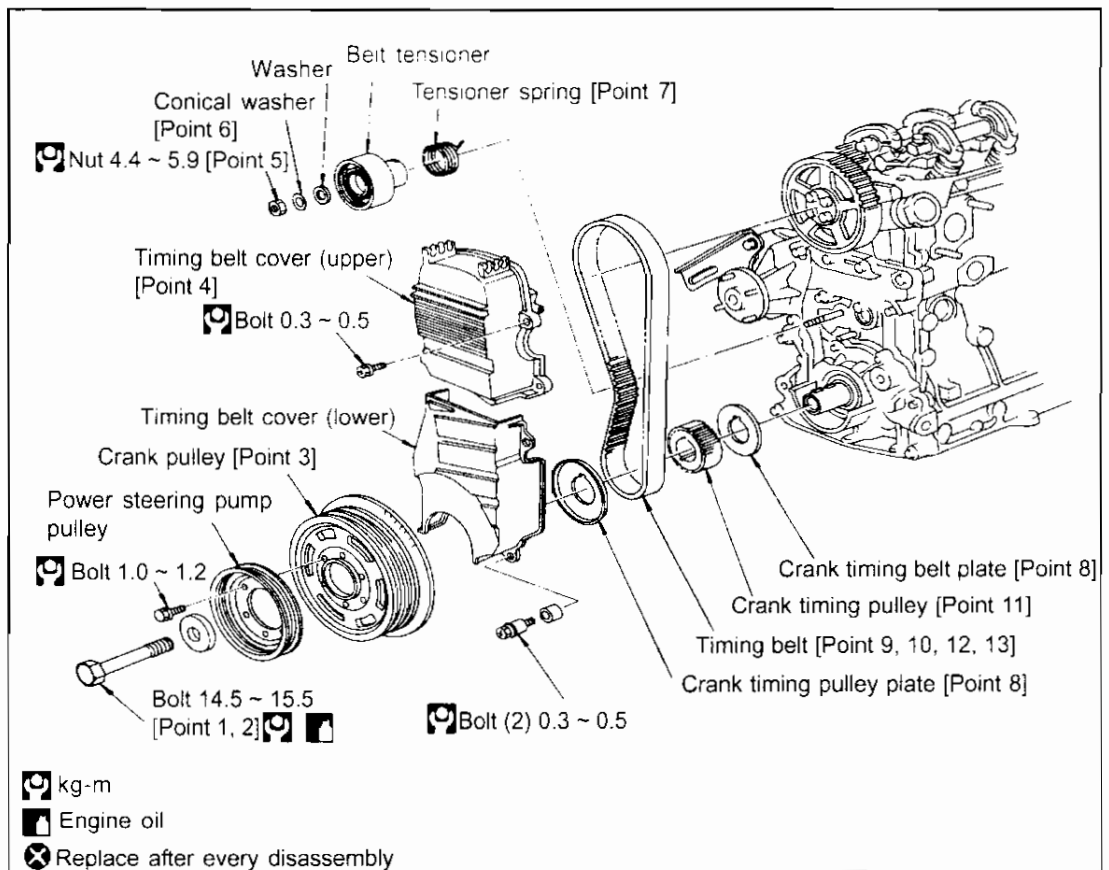

**Additional work required:**

- Drain and refill cooling water
- Remove and install the followings:
  - Under cover
  - Radiator, shroud
  - Cooling fan
  - Supplemental belts
  - Water pump pulley
  - Spark plugs
- Check No. 1 cylinder compression T.D.C position [Point 1]
- Install ring gear stopper [Point 3]

**[Point 1] No. 1 cylinder pressure T.D.C (top dead enter) inspection**

- Align the crank pulley timing mark and the belt cover timing indicator. At this time, the distributor rotor should be in the position shown in the diagram below, or No. 1 cylinder is in the compression T.D.C position.

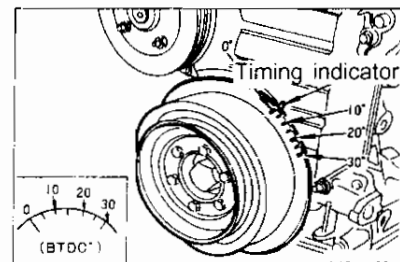
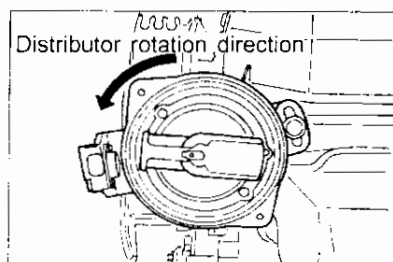

**[Point 2] Install ring gear stopper**

- Remove the starter motor and install the ring gear stopper.

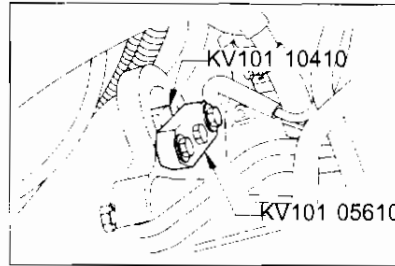

**[Point 3] Pulley puller (steering wheel puller)**

- Remove the crank pulley by using the pulley puller.  
(bolt size: M6 x 1.0 length below head 40 mm)

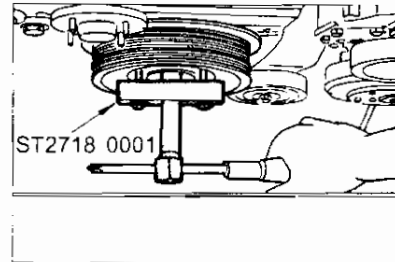

**[Point 4] Install timing belt cover**

- Attach the gasket (sponge rubber) on the timing belt cover (upper) as shown in the figure.

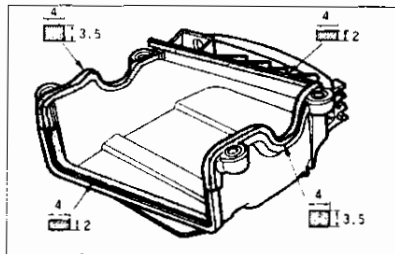

**[Point 5] Remove & install belt tensioner nuts**

- Secure the belt tensioner firmly with a hexagonal wrench when removing and installing the belt tensioner nuts.

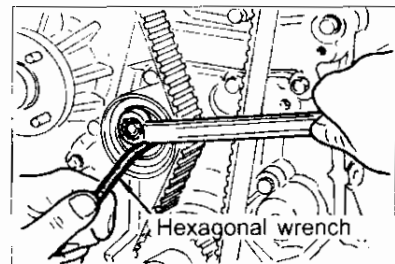

**[Point 6] Install conical washer**

- Pay close attention to the installation direction of the conical washers. The washer should be set with face the chamfered side facing the tensioner pulley side.

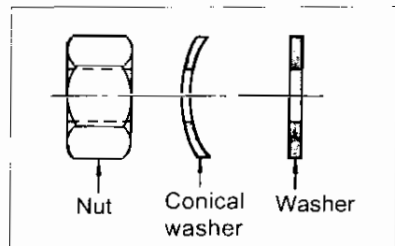

**[Point 7] Install tensioner spring**

- Assemble the tensioner spring so it engages the belt tensioner pulley as shown in the figure on right.

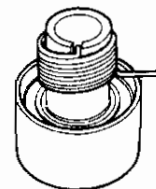

- The tensioner spring must be assembled together with the belt tensioner pulley in the cylinder block.

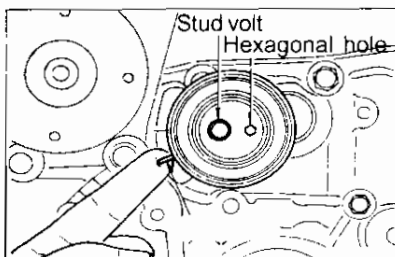

- Fix the belt tensioner and hook the spring on top of the stud bolt by rotating the spring anticlockwise.

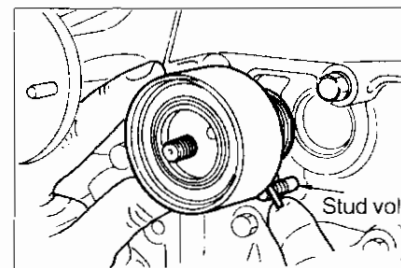

Spring wire diameter	Set angle	Free angle (-)
1.8 mm	Approx. 20°	Approx. 227°

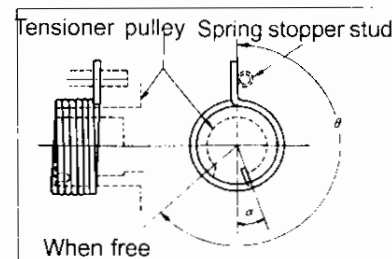

**[Point 8] Install crank pulley and plate**

- Be careful to observe front and rear positioning of timing belt plate, crank timing pulley and crank timing pulley plate when installation is performed.

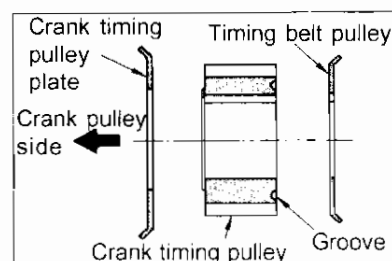

**[Point 9] Timing belt alignment mark verification**

- Check if the cam pulley alignment mark is aligned with the crank timing pulley alignment mark when No. 1 cylinder is at compression T.D.C.
- Check the number of ridges between the cam pulley and the crank timing pulley alignment marks.
- Mark on each pulley at the alignment position with white paint if the timing belt alignment mark (white paint) is not clear.
- Position the timing belt so the back surface arrow is facing the engine front and align the alignment mark (white paint) with cam pulley and the crank timing pulley alignment mark when installing a new timing belt.
- Check the ridges after the installation.

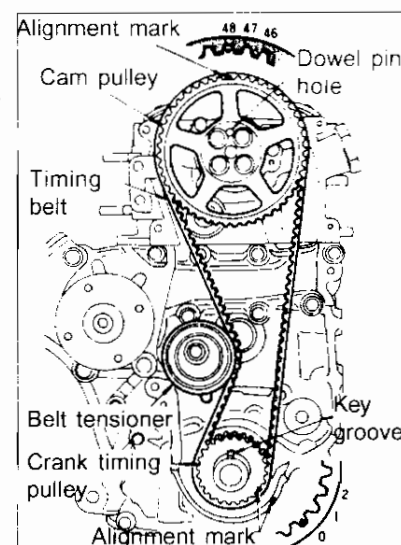

**[Point 10] Install timing belt**

- Assemble the tensioner spring so it engages the belt tensioner pulley (follow point 7).
- The tensioner spring must be assembled together with the belt tensioner pulley in the cylinder block.
- Insert hexagonal wrench into the belt tensioner hexagonal hole and rotate clockwise to tighten the nut temporarily.
- Align the timing belt alignment marks with each pulley marks and install timing belt on to pulley.
- Tighten the tensioner securing nuts to specified tightening torque. **Tightening torque (kg-m): 4.4 ~ 5.9**

**[Point 11] Crank timing pulley**

- Make sure to install the crank timing pulley in a correct way. Some crank timing pulley has two key grooves and alignment marks.

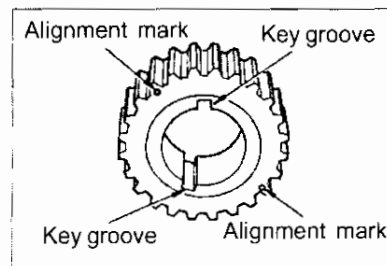

**[Point 12] Timing belt tension adjustment**

- Loosen all rocker shaft tightening bolts.
- Rotate the tensioner anticlockwise two to three times using hexagonal wrench. (it is not necessary to rotate belts).
- Fix the tensioner using hexagonal wrench and tighten the nuts to specified tightening torque. (At this stage specific tension will be applied to the belts automatically).

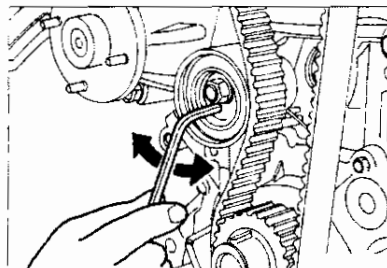

**[Point 13] Timing belt inspection**

- Replace timing belt if inspection indicates any problem.

Item	Condition	Cause
Tooth missing Cracked tooth		Camshaft lock Crank sensor lock
Cracks on rear side		Tensioner lock Engine overheat Interference with belt cover etc.
Wear and cracks on the side		Belt misalignment Belt plate malfunction
Worn teeth		Sliding motion resistance in crank sensor and the camshaft
Oil or water adhesion		Oil seal malfunction Water leaks in water pump

**9.6 REMOVE & INSTALL OIL PAN, OIL STRAINER, OIL FILTER**

- Refer to RB20DE, DET section later on in the manual for detail.

**10-1 COLLECTOR ASSY**  
**(1) Remove & install Collector ASSY**

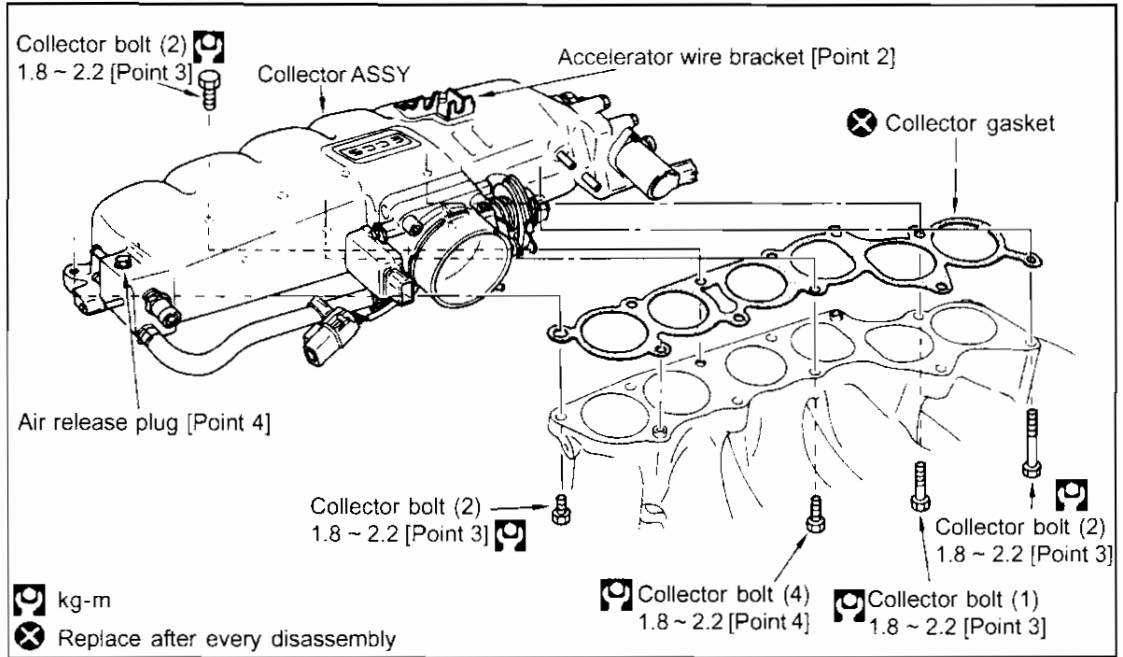

**Additional work required:**

- Release fuel pressure in the fuel line [Point 1]
- Acceleration control wire [Point 2]
- Drain and refill cooling water
- Air duct (RB20DE), Air inlet pipe (RB20DET)
- EGI harness connector, harness clamp
- All hoses

**[Point 1] Release fuel pressure**

- After starting the engine remove the fuel pump fuse and wait until the engine stops. Crank engine two or three times to consume fuel remaining in the fuel pipes.
- If the vehicle doesn't start, remove the fuel pump fuse and crank the engine four to five times to consume fuel remaining in the fuel pipes.

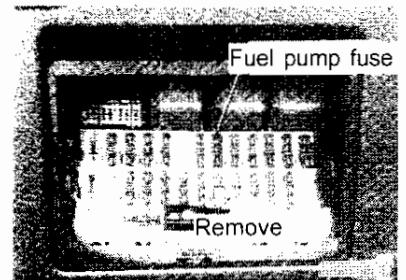

**Caution:**

The battery may become weak easily, use booster cable to connect to another battery if necessary.

**[Point 2] Accelerator wire adjustment**

- Loosen lock nut to provide adequate slack for the accelerator wire and pull outer case in direction of the accelerator. Return the lock nut 1.0 to 1.5 turns from the position the throttle drum starts moving (when there is no play in cable) and tighten.

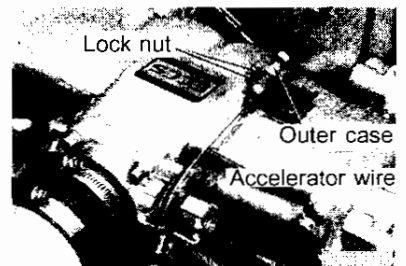

**Tightening torque (kg-m): 0.8 ~ 1.0**

**[Point 3] Remove & install collector bolts**

**Removal**

- Remove the nuts in the reverse order of the figure on right.

**Installation**

- Install the nuts in the order shown in the figure on right uniformly in two to three stages.

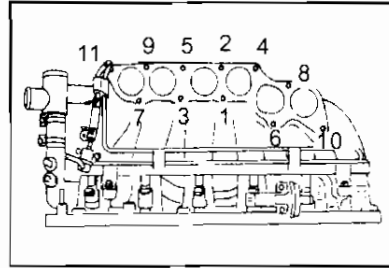

Position	No. required	Bolt length below head (mm)
7, 10	2	105
8	1	65
1, 3, 4, 6,	4	40
2, 5, 9, 11	4	30

**[Point 4] Air release plug**

- For more detail refer to cooling system later in the manual.

**Caution:**

Do not remove the air release plug when the engine is still warm.

- Make sure to remove air release plug when refilling the cooling water to release air within the engine completely (overheat prevention).

**Tightening torque (kg-m): 0.7 ~ 0.8**

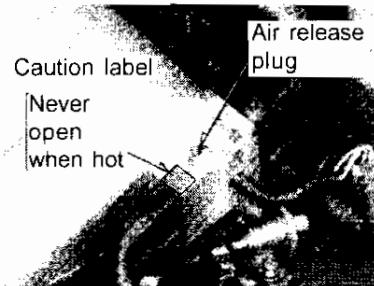

**(2) Collector ASSY disassembly & assembly**

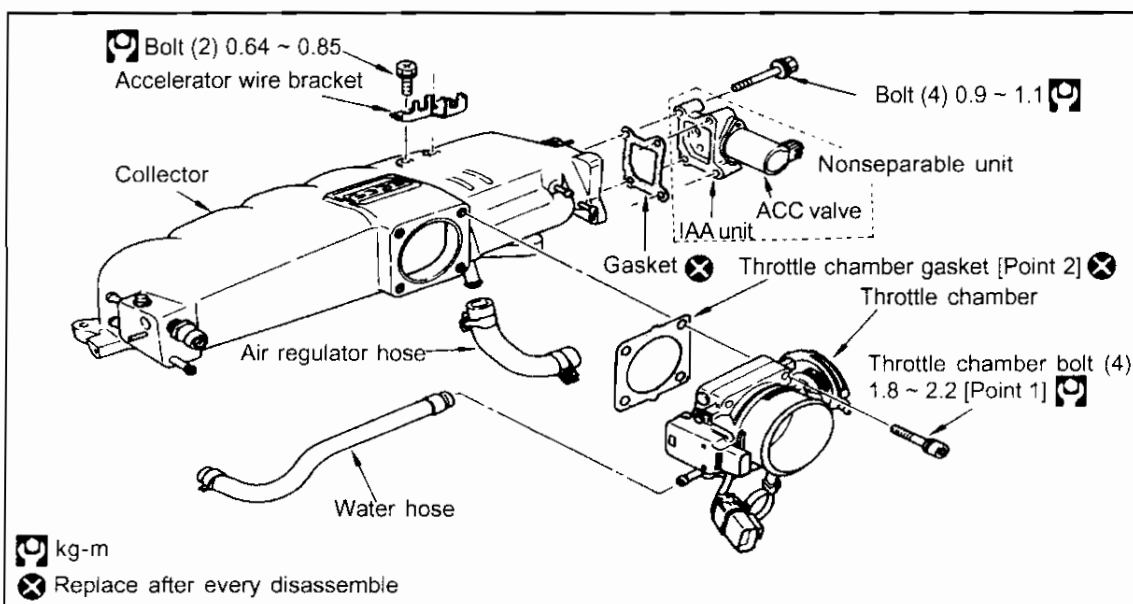

**Additional work required:**

- Remove and install collector ASSY

**[Point 1] Remove & install throttle chamber bolts**

**Removal**

- Remove the bolts in the reverse order of the figure on right.

**Installation**

- Install the bolts in the order shown in the figure on right uniformly in two stages.

**Tightening torque (kg-m):**    **First stage**    **0.9 ~ 1.1**  
    **Second stage** **1.8 ~ 2.2**

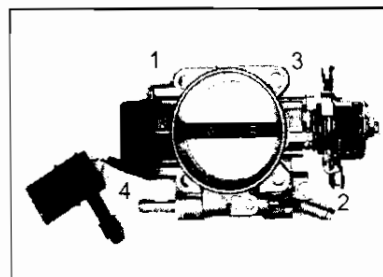

**[Point 2] Throttle chamber gasket**

- Check the installation direction before installing the throttle chamber gasket.

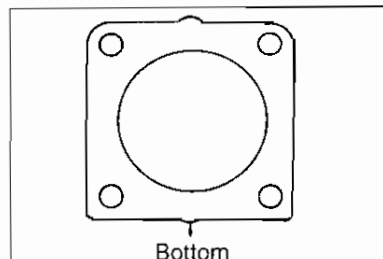

**10-2 INTAKE MANIFOLD ASSY**

**(1) Remove & install intake manifold ASSY**

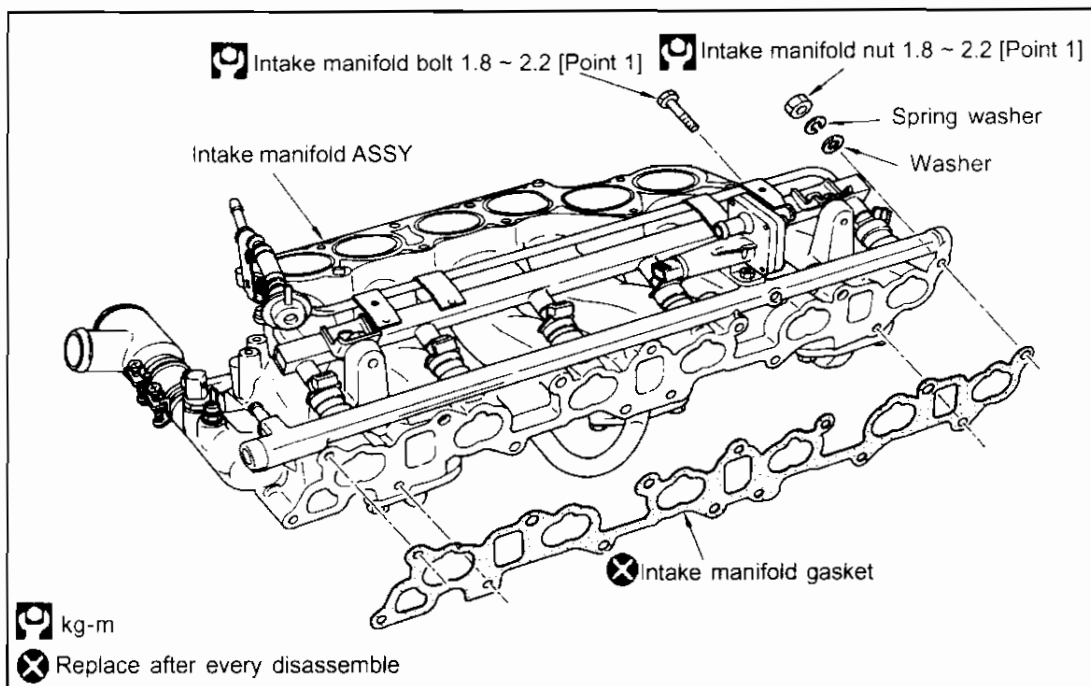

**Additional work required:**

- Remove & install connector ASSY
- ECCS harness connector, all hoses

**[Point 1] Remove & install intake manifold ASSY bolts and nuts****Removal**

- Remove the bolts and nuts in the reverse order of the figure on right.

**Installation**

- Install the bolts and nuts in the order shown in the figure on right.

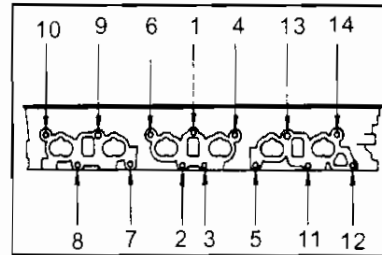
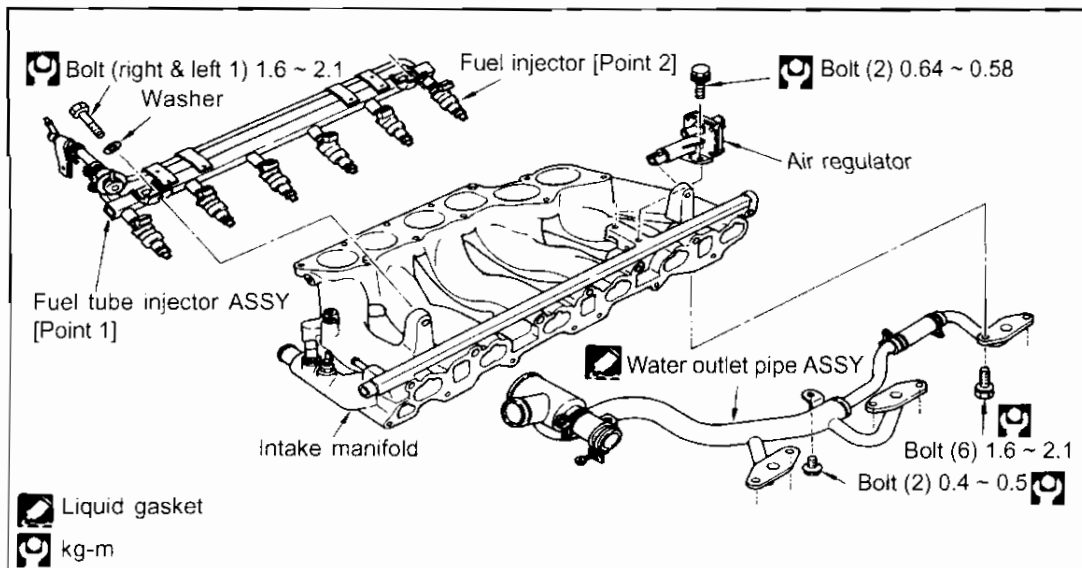
**(2) Intake manifold ASSY disassembly & assembly****Additional work required:**

- Remove & install intake manifold ASSY

**[Point 1] Fuel tube ASSY**

- Replace the O-ring to new ones when removing and installing the pressure regulator and the fuel damper.

**Caution:**

Care must be taken not to scratch or damage the fuel tube O-ring area when installing the pressure regulator.

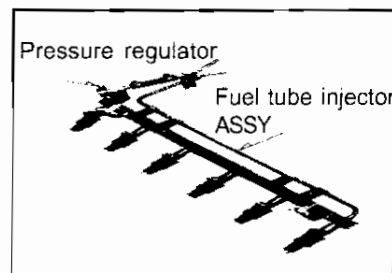
**[Point 2] O-ring (for fuel injector pressure regulator)****Precautions when handling**

- Never reuse O-rings.
- Coat the O-ring with engine oil (7.5W-30 or equivalent), but do not apply solvent as this may remove the oil coating.
- Avoid using dirty O-rings and do not allow dirt, dust or foreign objects to adhere to O-rings or other equipment.
- Care must be taken not to scratch, twist or stretch them by tools or operator's fingernails when installing O-rings.
- Do not decenter or rotate the fuel injectors and the pressure regulator when inserting them into the fuel tube.

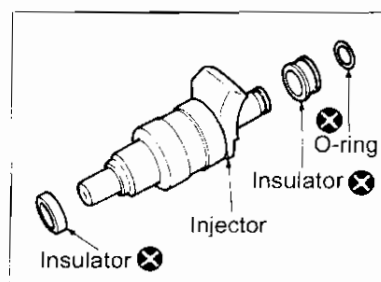

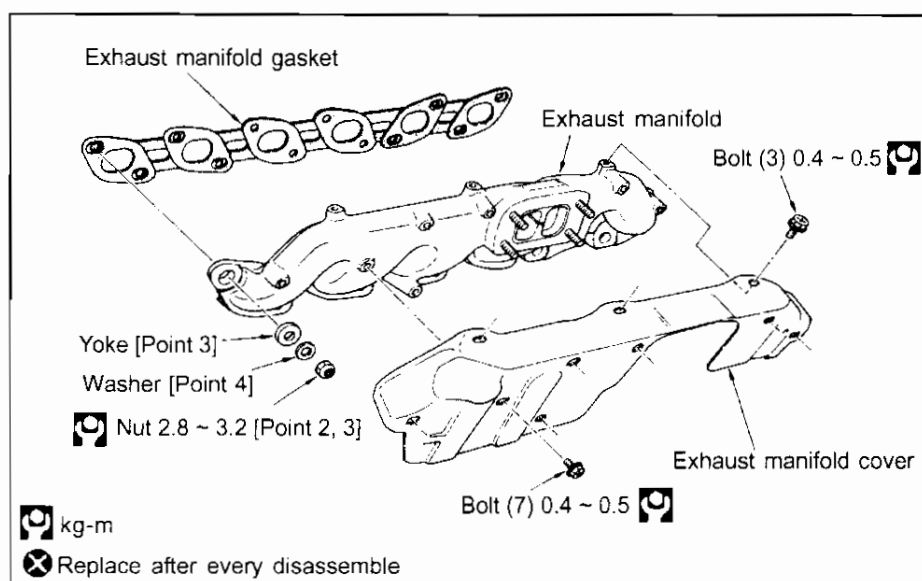

**10-3 REMOVE & INSTALL EXHAUST MANIFOLD ASSY****Additional work required:**

- Under cover
- Disassemble exhaust front tube
- Exhaust sensor connector
- Gas leak inspection [Point 1]

**RB20DET only**

- Inter cooler air inlet tube hose
- Turbocharger

**[Point 1] Gas leak inspection**

- After removing the exhaust manifold, make sure there are no traces of gas leaks from any parts.
- After the installation, crank the engine and check for any gas leaks.

**[Point 2] Remove and install exhaust manifold nuts****Removal**

- Removal is the reverse of installation sequence shown in the diagram on right.

**Installation**

- The installation sequence is shown in the diagram on right.

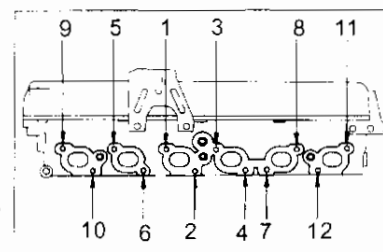

**[Point 3] Yoke**

- Make sure not to make mistake between No. 3 and No. 4 yoke as configuration is different.

Item	D (mm)
No.3 & No.4 port	22
Other than those above	24

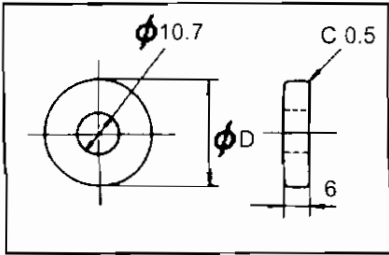

**[Point 4] Install washer**

- Make sure the washer is facing correct way when installing.

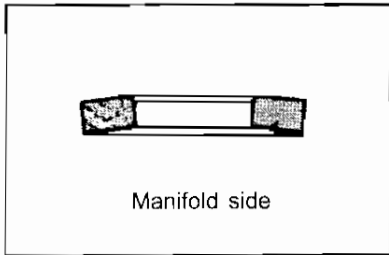

**10-4 REMOVE & INSTALL SPARK PLUG**

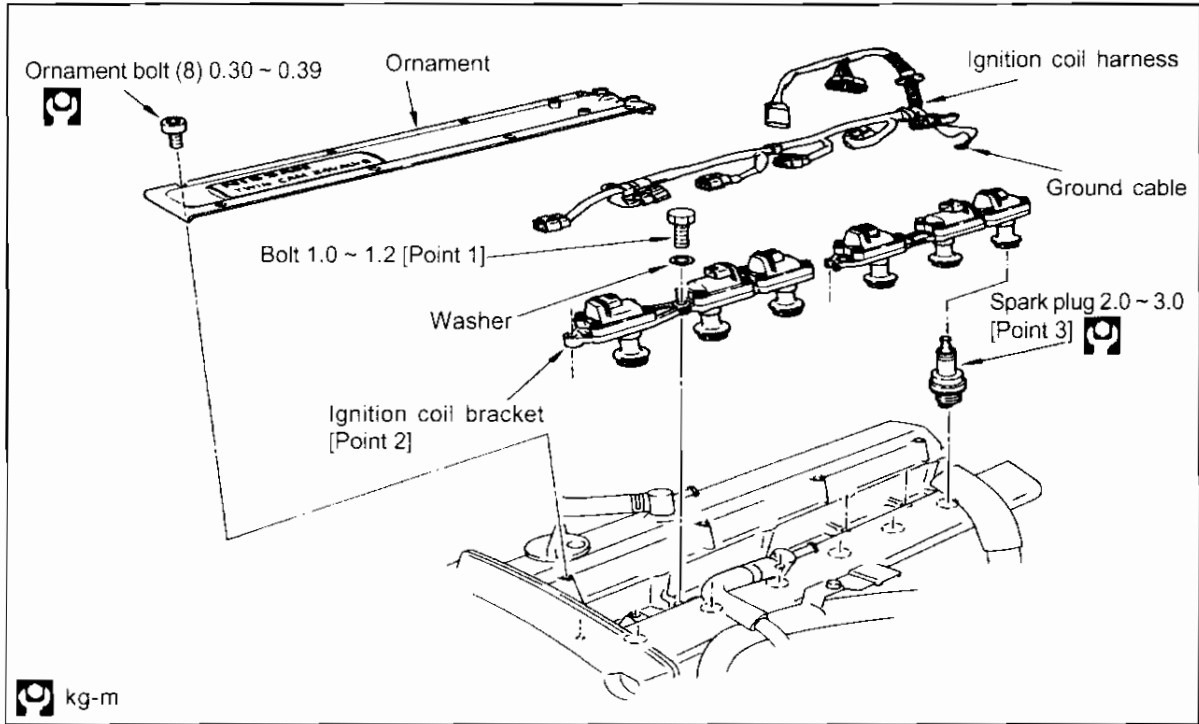

**Additional work required:**

- Air duct (RB20DE), Air inlet pipe (RB20DET)
- Blowby hose
- Power transistor

**[Point 1] Remove & install ignition coil bracket bolt**

- Length of the bracket bolt between RB20DE and RB20DET are different.

Item	RB20DE	RB20DET
Bolt length (mm)	22	25

**[Point 2] Install ignition coil bracket**

- The ignition coil bracket thickness differs between RB20DE and RB20DET vehicles.
- When installing ignition coil bracket to cylinder head, check that ground line is connected securely.

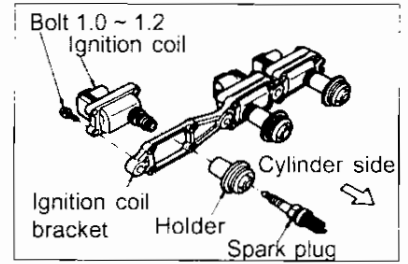

**[Point 3] Spark plug maintenance**

- The Gap inspection and adjustment is not necessary as platinum tip is used.
- Change the spark plug every 100,000 km.
- When using compressed air spark plug cleaner, clean the plugs at maximum pressure of 6 kg/cm<sup>2</sup> for no more than 20 seconds.
- Do not use wire brush to clean plugs.

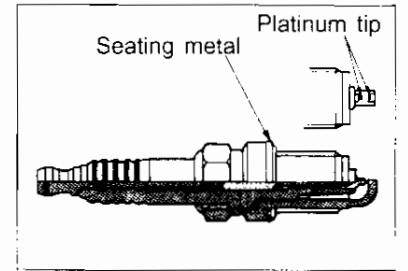

**10-5 REMOVE & INSTALL ROCKER COVER**

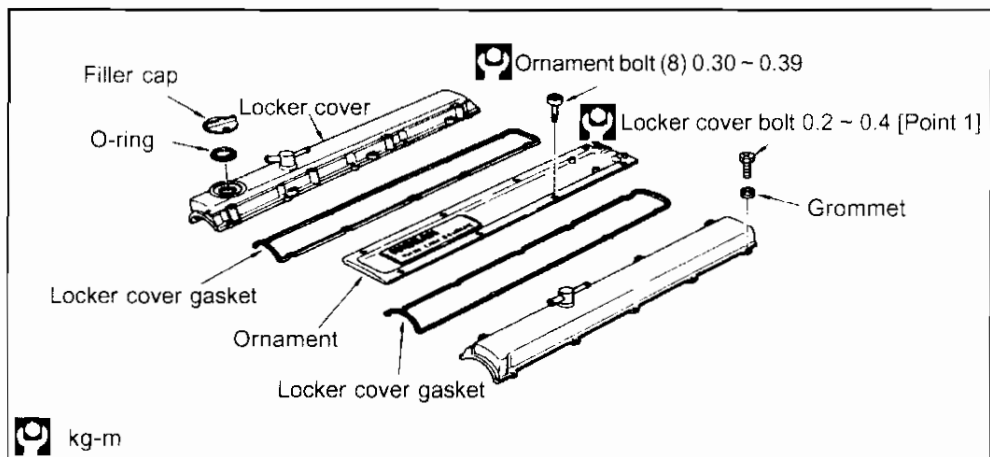

**Additional work required:**

- Air duct (RB20DE), Air inlet (RB20DET)
- Blowby hose

**[Point 1] Remove & install rocker cover screws**

**Removal**

- Perform removal in reverse order of sequence shown in the figure on right.

**Installation**

- Perform installation in sequence shown in the figure on right.

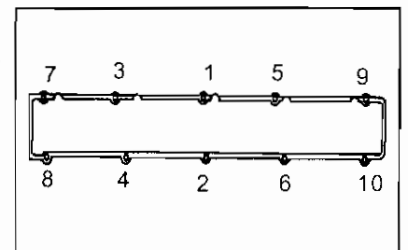

10-6 REMOVE & INSTALL TIMING BELT

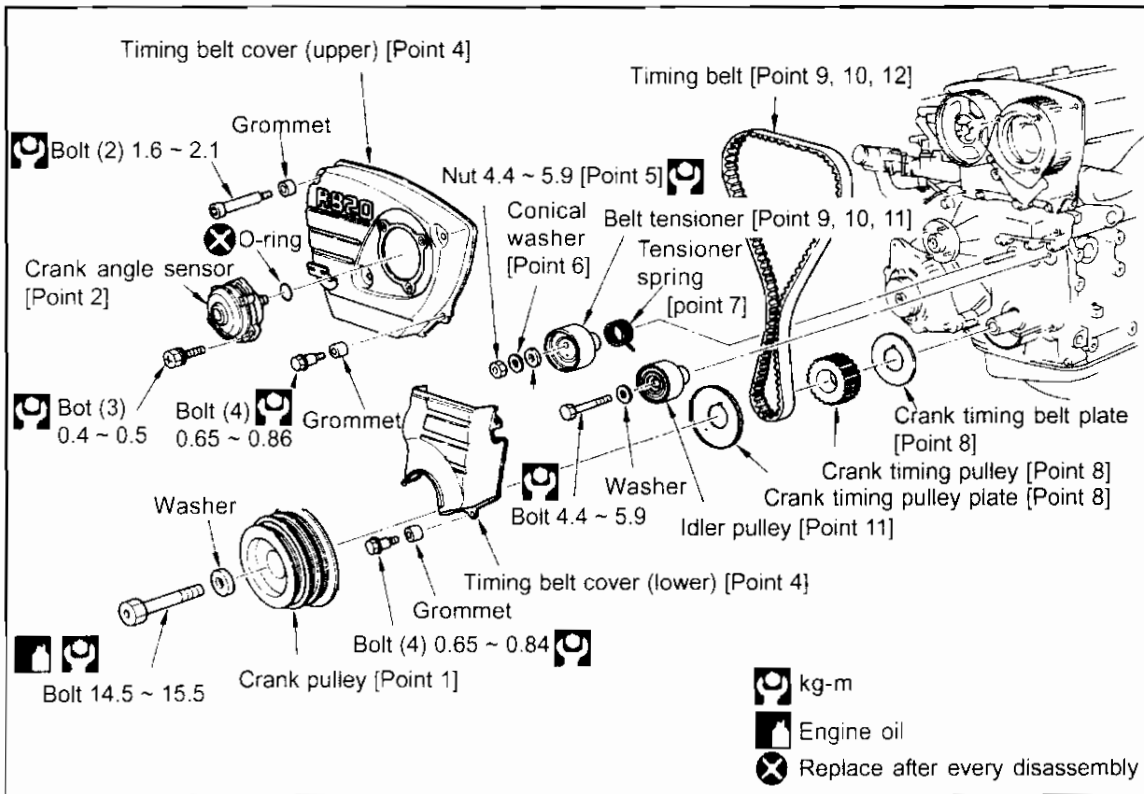

**Additional work required:**

- Under cover
- Drain and refill cooling water
- Radiator, fan shroud
- Cooling fan
- Supplemental belts
- Water pump pulley
- Spark plug
- No. 1 cylinder compression T.D.C position [Point 1]
- Install ring gear stopper [Point 2]

**[Point 1] No. 1 cylinder pressure T.D.C (top dead enter) inspection**

- Align the crank pulley timing mark and the belt cover timing indicator (0° position). At this time, the No. 1 cylinder is in the compression T.D.C position when the camshaft is located as described in the following situations.

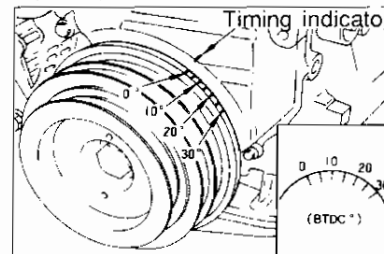

- No. 1 cylinder is at the compression top dead centre when both the intake and the exhaust side cams do not move the valve lifters.

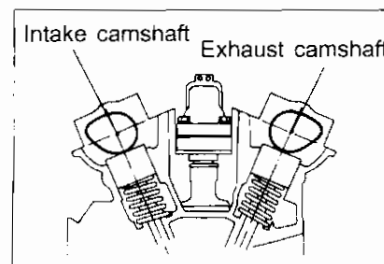

- Remove the locker cover oil filler cap from intake side and check that the front end of the camshaft faces intake side.

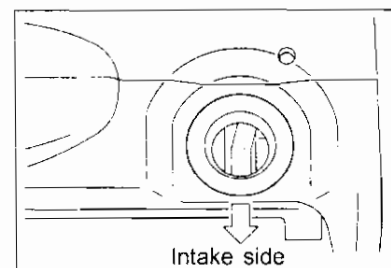

### [Point 2] Install crank angle sensor

- Apply chassis grease to the drive unit (spline) during installation.
- There is a flange inside the drive unit spline so the spline has only one insertion position. Check the alignment visually before assembly.
- Check that the crank angle sensor can be easily inserted in belt cover holes and sensor moves lightly to right and left, then tighten the bolts.
- When the sensor doesn't move lightly, loosen belt cover bolts to position when the crank angle sensor was inserted. Move the belt cover lightly horizontally and vertically to align it so the belt cover holes and the camshaft centre are aligned. Then tighten the bolts so the crank angle sensor moves lightly.

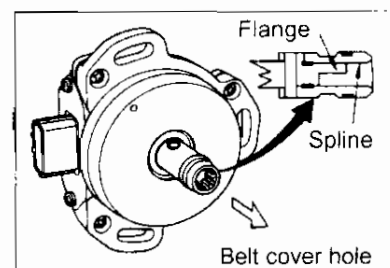

### [Point 3] Remove & install crank pulley and the bolt

- Remove the starter motor and attach the ring gear stopper.

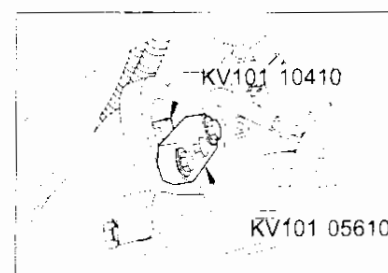

- Use a pulley puller (steering wheel puller) to remove crank pulley (bolt size: M6 x 1.0 length below head approx. 50 mm)

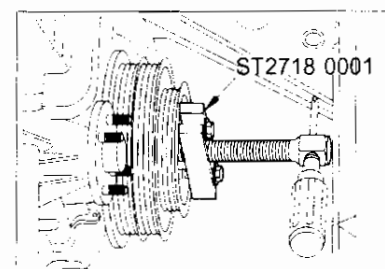

### [Point 4] Remove & install timing belt cover

- The timing belt cover is separated into upper and lower parts. After crank angle sensor is removed, remove the timing belt cover in the order of upper and then lower.
- Installation is in reverse sequence of removal procedures.

#### Caution:

Care must be taken not to scratch or damage the dried liquid packing when removing and installing the timing belt cover.

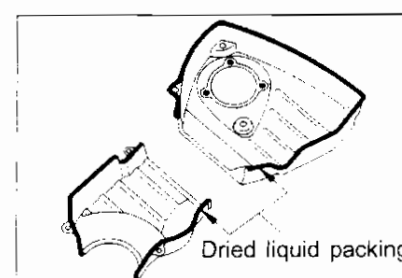

**[Point 5] Remove & install belt tensioner nuts**

- Secure the tensioner with hexagonal wrench when removing and installing the belt tensioner.

Caution:

Do not loosen inserted stud when disassembly.

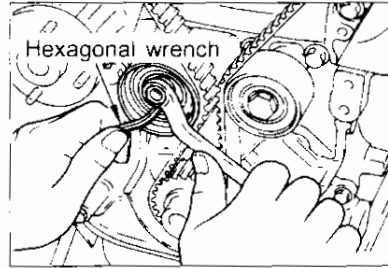

**[Point 6] Install conical washer**

- Pay attention to the installation direction of the conical washers. The washer should be set with face the chamfered side facing the tensioner pulley side.

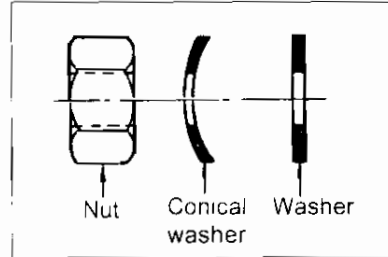

**[Point 7] Install tensioner spring**

- Assemble the tensioner spring to the belt tensioner pulley as shown in the figure.
- The tensioner spring must be assembled together with the belt tensioner pulley in the cylinder block.

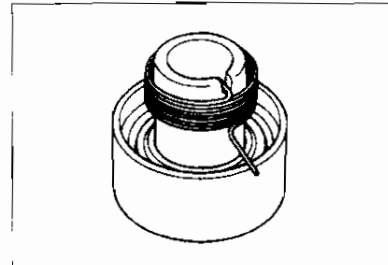

- Hook the tensioner spring on the upper side of the tensioner spring stud when the tensioner pulley is free.

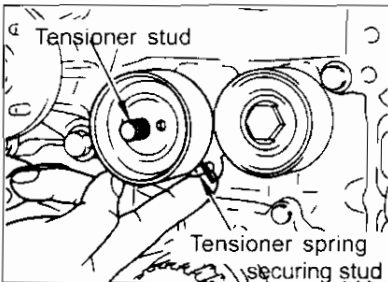

**Tensioner spring specifications**

Spring wire diameter	Set angle	Free angle	Classification paint
1.8	Approx. 20°	Approx. 163°	Yellow

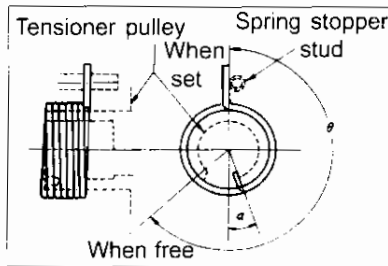

**[Point 8] Install crank timing pulley & plate**

- Care must be taken of the rear and front positioning when installing timing belt plate, the crank timing pulley and the timing pulley plate.

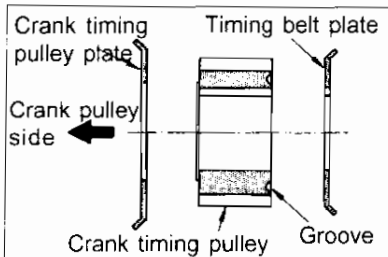

**[Point 9] Timing belt alignment mark verification and installation**

- Paint a mark on the belt that indicates rotation direction if paint on the upper belt is unclear when disassembly.
- Position the alignment marks on the intake and the exhaust cam pulleys with the respective belt cover alignment marks. (No. 1 cylinder is at T.D.C)
- Position the alignment mark on the crank timing pulley with the respective oil pump housing alignment marks. At this time the groove must be straight up (no. 1 cylinder is at T.D.C).
- Move the belt tensioner clockwise 70 ~ 80 degree angle, and secure it temporarily with the belt tensioner nut.
- Install the belt by aligning the timing belt and the pulley marks. Align the number of ridges of exhaust cam pulley alignment mark and the crank pulley (inner) alignment mark as shown in the figure on right.
- After loosening the nuts and adjusting the belt tension, secure the tensioner with the hexagonal wrench so it will not rotate together and tighten the nut.

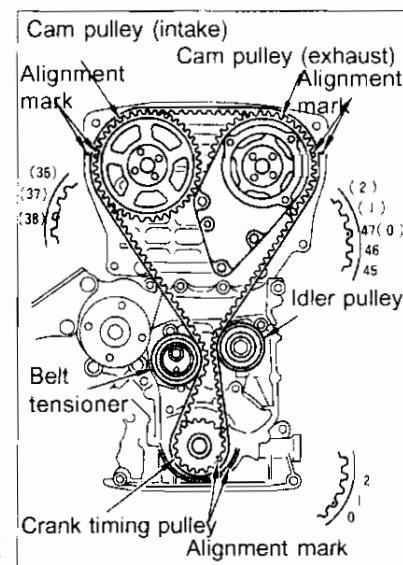
**Caution:**

- (1) Make sure the timing belt engages correctly with the pulley and does not flat when assembling the timing belt.
- (2) Replace belts whenever possible when disassembly is performed.

**[Point 10] Timing belt tension adjustment**

- Remove the spark plug and align the timing belt alignment mark and the pulley marks and install timing belt on to each pulley.
- Loosen the tensioner securing nut so the belt tension is applied by the tensioner spring.
- In this condition, rotate the crank pulley clockwise more than two turns to check the belt movement and stop slowly at No. 1 cylinder compression T.D.C point.
- Insert the hexagonal wrench in hexagonal hole. Hold the tensioner by hand so the tensioner does not move, and tighten the tensioner securing nut to specified tightening torque.

**Tightening torque (kg-m): 4.4 ~ 5.9**

- The initial tension on the belt in this condition should be approximately 20 kg.

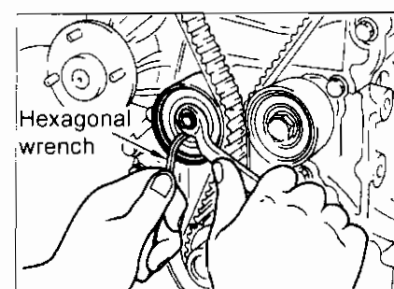



**[Point 11] Install idler & tensioner pulley**

- Do not loosen inserted studs when disassembly. If studs are loosened, coat inserted stud with locktite solution (Japan Locktite KK) or equivalent.

**[Point 12] Timing belt inspection**

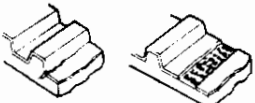
- Replace timing belt if any problems are indicated at the inspection.

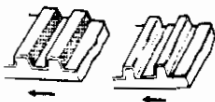
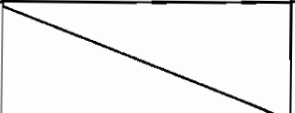
Item	Condition	Cause
Tooth missing Cracked tooth		Camshaft lock Crank sensor lock
Cracks on rear side		Tensioner lock Engine overheat Interference with belt cover etc.
Wear and cracks on the side		Belt misalignment Belt plate malfunction
Worn teeth		Sliding motion resistance in crank sensor and the camshaft
Oil or water adhesion		Oil seal malfunction Water leaks in water pump

**Caution:**

Do not twist or bend the timing belt . Make sure there is no oil film or water on the belt.

**10-6 REMOVE & INSTALL WATER PUMP**

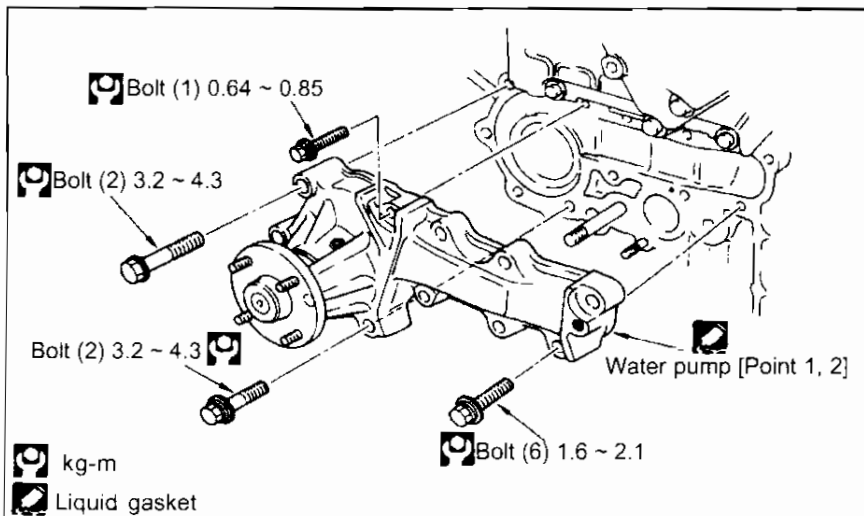

**Additional work required:**

- Drain and refill cooling water
- Timing belt cover



**[Point 1] Remove & install water pump****Remove**

- Care must be taken not to get coolant on the timing belt. Wipe it off immediately if any water does spill.
- Remove the water pump bolts in the reverse order shown.

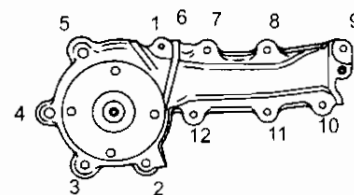
**Installation**

- Install the bolts in the numbered sequence shown.

- Wipe off oil liquid gasket from the cylinder block and on the water pump and wipe the surface with white gasoline.
- Apply continuous bead of liquid gasket (KP510 00150) to water pump sealing surface.

**Caution:**

Be sure liquid gasket is 2.0 to 3.0 mm wide.

Installation must be carried out within 5 minutes after liquid gasket application.

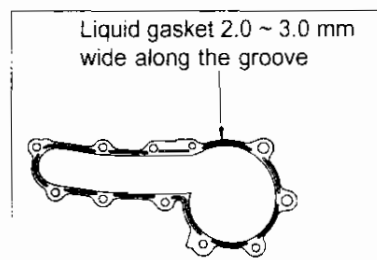
**[Point 2] Water pump inspection**

- Rotate the water pump by hand and check for abnormal sound and smooth operation.
- There must be no traces of water leaks.

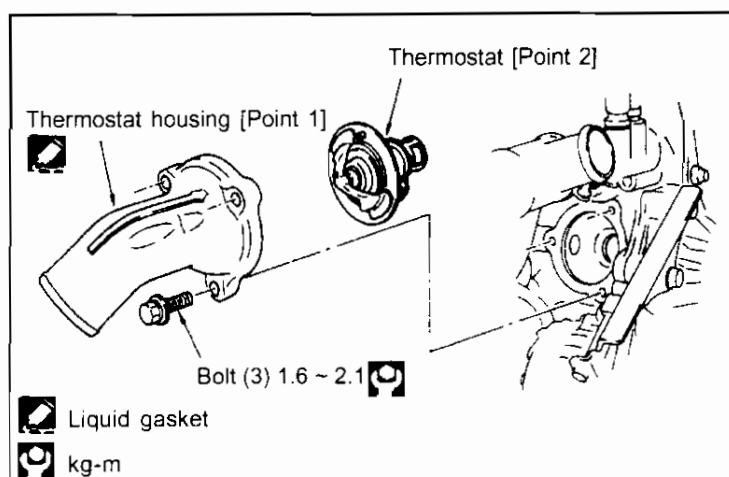
**10-7 REMOVE & INSTALL THERMOSTAT****Additional work required:**

- Disconnect and connect water inlet hose.
- Drain and refill cooling water

**Caution:**

Loosen engine drain plug to remove cooling water from cylinder block.

**[Point 1] Remove & install thermostat housing  
Removal**

- Insert the screwdriver handle into thermostat housing and move it up and down lightly to remove the housing.

**Installation**

- Remove old liquid gasket on the thermostat housing and the cylinder block and wipe off the surface with white gasoline.
- Cut nozzle end of liquid gasket (KP510 00150) tube.
- Apply a continuous bead of liquid gasket to sealing surface using the tube presser. Install the housing within 5 minutes after coating liquid gasket.

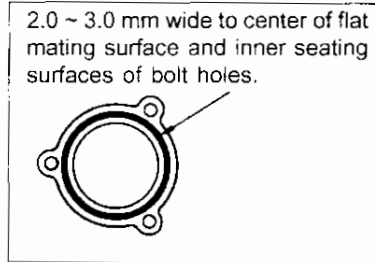

**[Point 2] Install thermostat**

- 'Top' mark (jiggle valve) must face up when thermostat is inserted in housing.

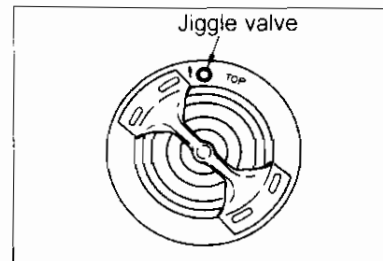

**[Point 3] Thermostat inspection**

- Check the valve opening temperature and maximum valve lift.
- Hang the thermostat by string in valve and submerge in heated water in double walled container and stir water while heating it up.
- The opening temperature is the temperature when the valve opens and thermostat falls from string.

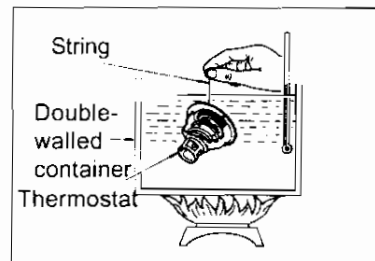

	Standard, cold climate
Valve opening temperature (°C)	76.5
Max. valve lift mm/ °C	10 / 90

**10-8 REMOVE & INSTALL OIL PAN, OIL STRAINER AND OIL FILTER**

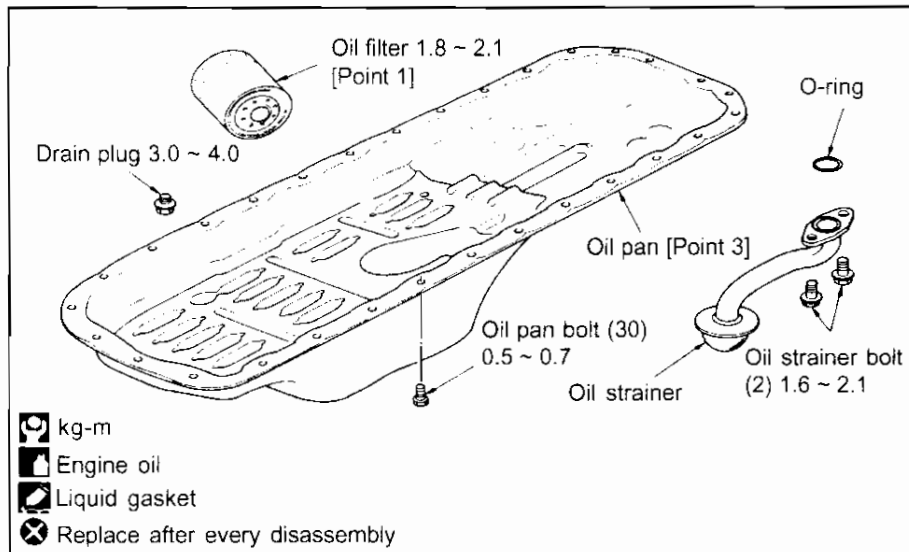

**Additional work required:**

- Front stabilizer
- Radiator fan, shroud
- Right & left engine gusset
- Engine rear plate (lower) (A/T vehicles)
- Engine oil

**[Point 1] Remove & install oil filter**

**Removal**

- Use oil filter wrench to remove the oil filter.

**Installation**

- Before installing new oil filter, wipe off dust etc. from cylinder block mounting surface. Apply a thin coat of engine oil to oil filter O-ring.
- Screw oil filter on bracket by hand until a slight resistance is felt, then tighten an additional 2/3 turn with oil filter wrench. After tightening, start engine and check for oil leaks.



**[Point 2] Remove & install oil pan bolts**

**Remove**

- Remove the bolts in reverse sequence of figure on right.

**Installation**

- Install the bolts in sequence shown in figure on right.

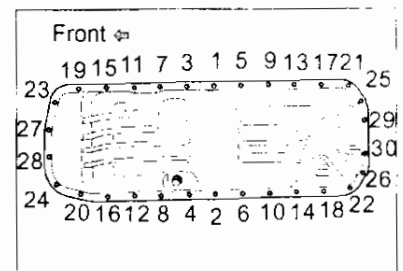

RB20DE / DET ENGINE

**[Point 3] Remove & install oil pan****Removal**

- Use seal cutter to remove the oil pan.

**Caution:**

- (1) After removing the oil pan, remove oil liquid gasket on the oil pan flange groove and the oil block using the scraper. Make sure to remove liquid gasket dropped inside the oil pan.
- (2) Care must be taken not to damage the oil pan.

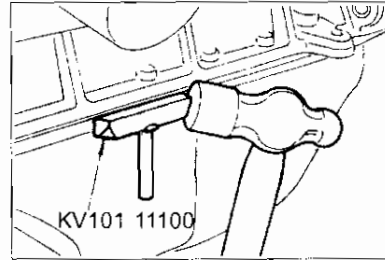

- Remove the engine mounting nuts (oil pan side) and use the hoist crane to move the oil pan forward. Take off the oil strainer bolts using the wrench before removing the oil pan.

**Caution:**

Care must be taken not to pull the hoses and harnesses too much when lifting up the engine using the hoist crane.

**Installation**

- The following procedure must be carried out within 5 minutes:
  - Apply a continuous bead of liquid gasket (KP510 00150) to sealing surface using a tube presser.
  - Install the oil pan within 5 minutes after coating.

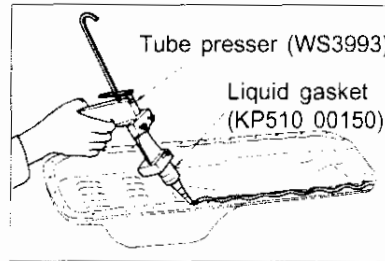
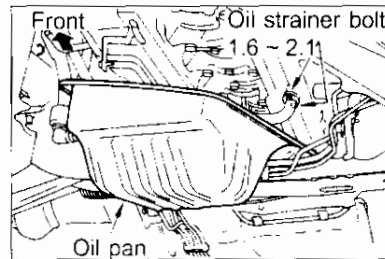
**[Point 4] Oil leak and oil pressure inspection**

- Start the engine and check for any oil leak and the oil pressure. To check the oil pressure release the oil pressure switch and use the oil pressure gauge.

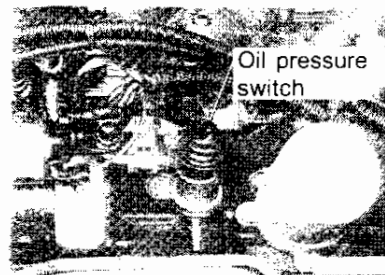
**[Point 5] Install oil strainer**

- Check to make sure the O-ring is installed properly before installing the oil strainer.

**Tightening torque (kg-m): 1.6 ~ 2.1**

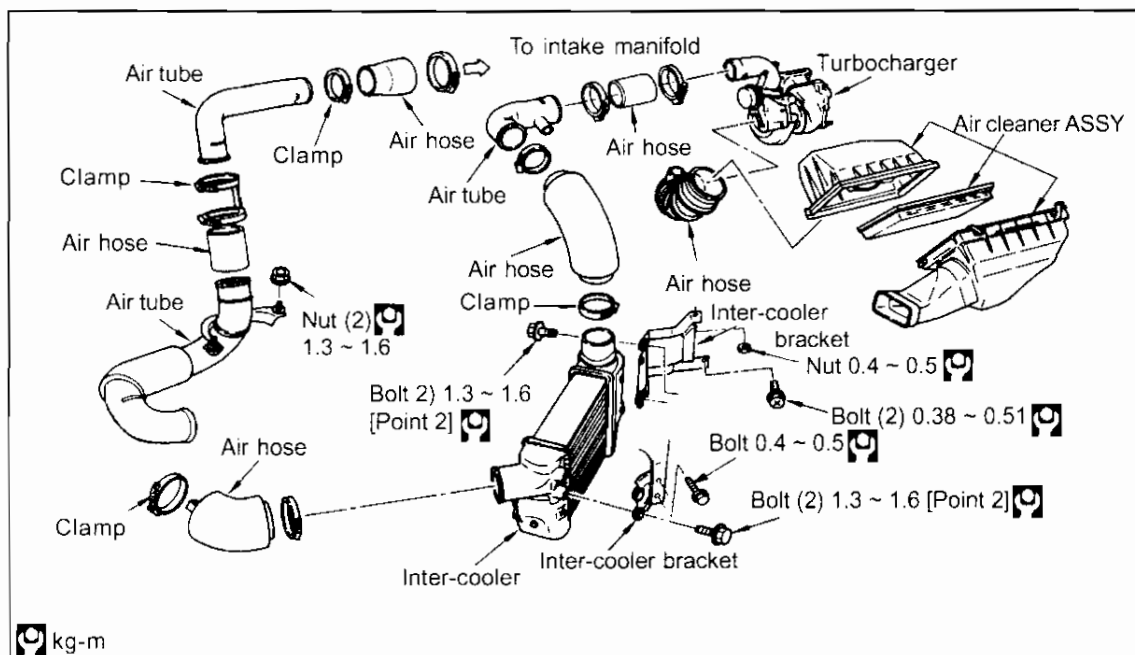
**10-9 REMOVE & INSTALL INTERCOOLER (RB20DET)****Additional work required:**

- Left front fender protector
- Fender stay
- Bonnet [Point 1]

**[Point 1] Remove & install bonnet**

- Remove left side bonnet bolts only (Lift up left side of the bonnet to operate).

**[Point 2] Remove & install intercooler**

- Remove the fender protector then remove cooler bolts to remove inter-cooler. Take care not to damage the fins.

**Caution:**

The fins are aluminium and can be damaged easily. Never place anything on the intercooler or allow tools or other hard objects to contact the fins.

The main unit (tank, fins, tube) cannot be disassembled.

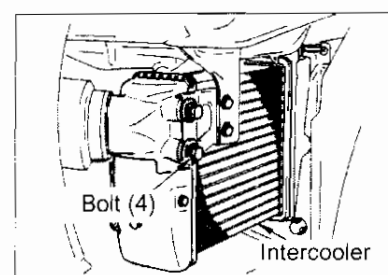

**10-10 Remove & Install turbocharger ASSY (Include fault diagnosis)**

**(1) Removal & installation**

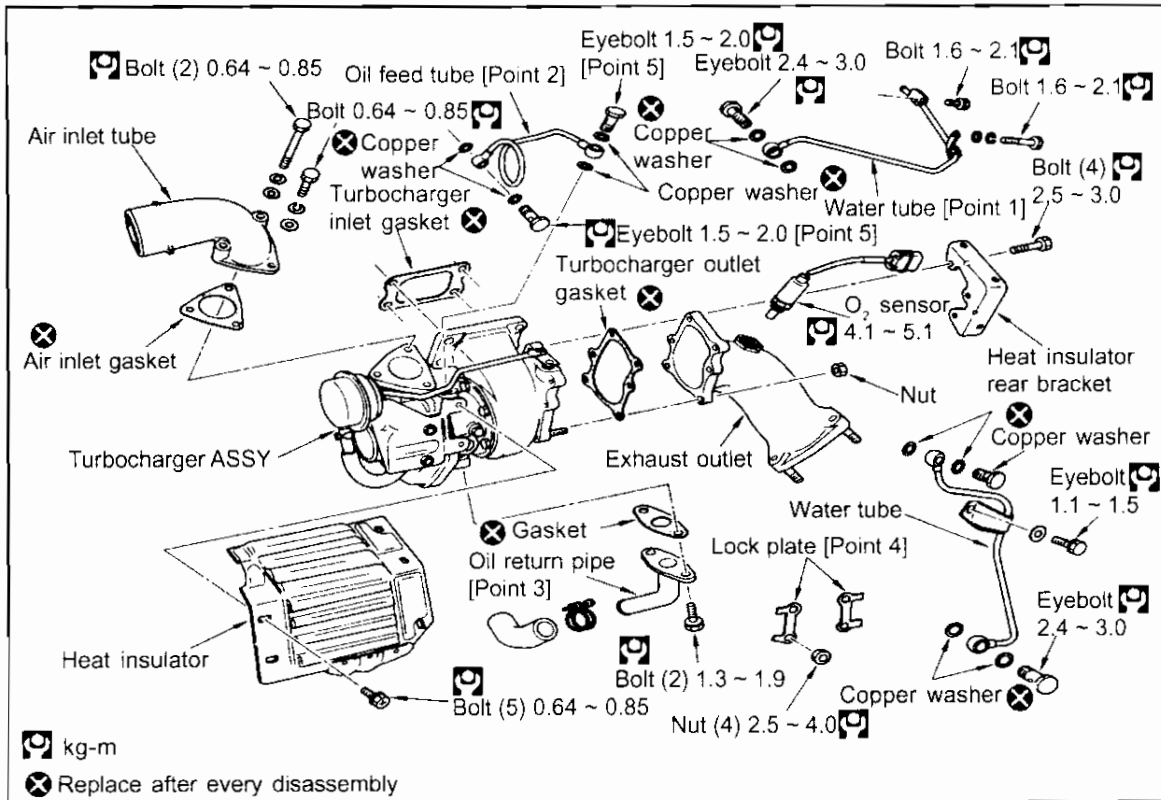

**Additional work required:**

- Under cover
- Assemble & disassemble exhaust front tube
- O<sub>2</sub> sensor connector
- Intercooler air inlet tubes, hoses
- Air inlet pipe

**[Point 1] Remove water outlet tube**

- Remove the water outlet tube by first removing the clamp located on the rear side of the cylinder block.

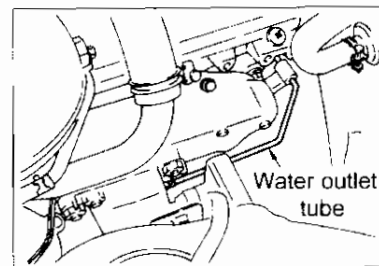

**Inspection**

- After cleaning water inlet and outlet tube with radiator cleaner, blow with compressed air and check for rust or clogging.

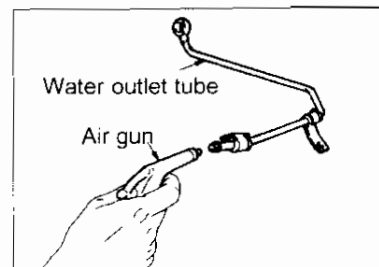

## RB20DET ENGINE

**[Point 2] Remove oil feed tube**

- Remove the oil feed tube by first removing the cylinder block and turbocharger eyebolts.

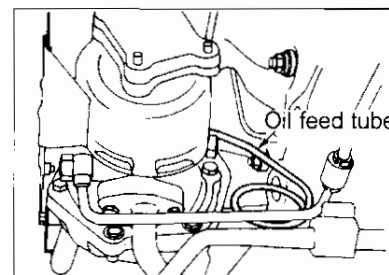
**Inspection**

- After cleaning oil feed tube with engine conditioner, blow with compressed air and check for clogging.

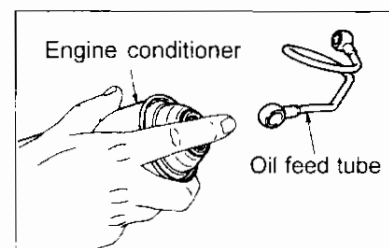
**[Point 3] Remove oil return pipe**

- Remove the oil return pipe by first removing the oil pan clamp and the turbocharger bolts.

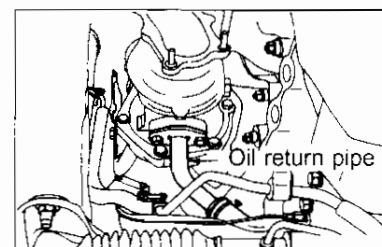
**[Point 4] Remove & install lock plate****Removal**

- Spread the lock plate pawls with a screwdriver and loosen the nuts.

**Installation**

- Position the lock plates and turbocharger mounting nuts. After tightening the nuts, bend lock plate pawls onto the nuts.

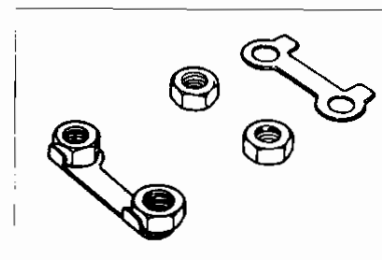
**[Point 5] Eyebolt determination**

- Oil feed (cylinder block side and turbocharger side) eyebolts are stamped "G".

**Installation order**

- Turbocharger main unit
- Water feed tube
- Oil feed tube
- Water outlet tube
- Oil return pipe

**(2) Turbocharger unit inspection**

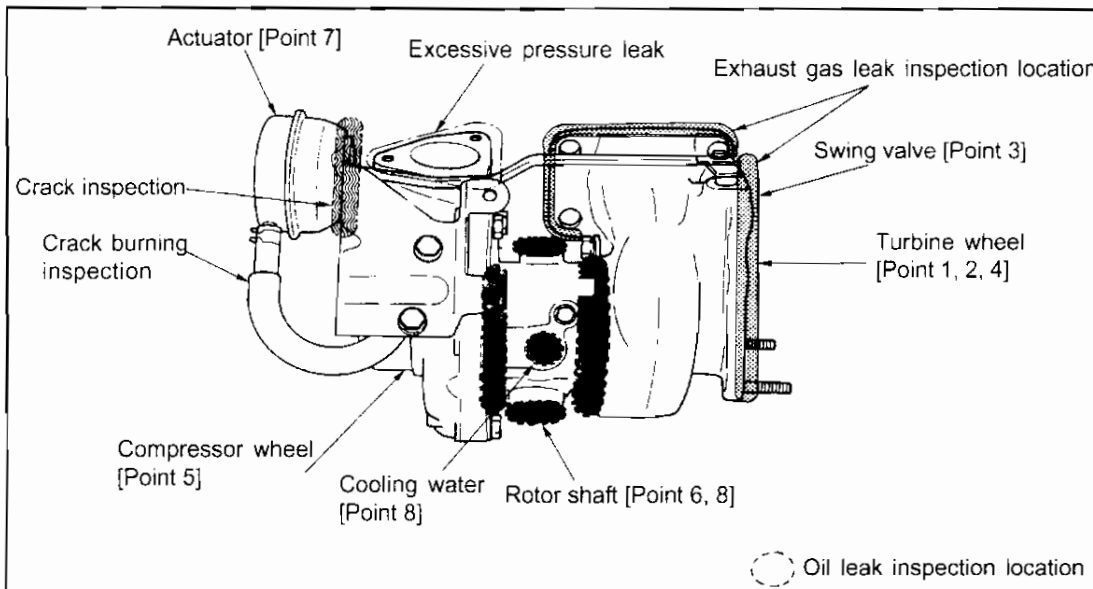

**[Point 1] Rotor shaft inspection**

- There must be no heaviness or dragging and the shaft must turn smoothly when rotor shaft is turned by finger.

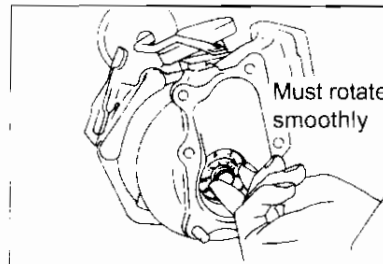

**[Point 2] Turbine wheel inspection**

- Oil must not adhere to surfaces.
- There must be no carbon accumulation.
- The vanes of the turbine rotor must not be bent.
- There must be no interference with turbine housing.

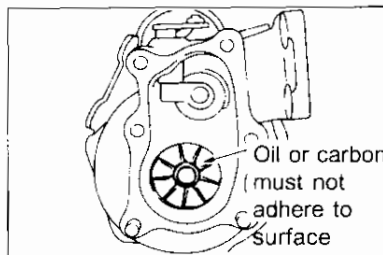

**[Point 3] Swing valve inspection**

- Remove actuator rod pin and make sure the swing valve moves smoothly without deformation or cracks.
- Make sure there are no misaligned seating surfaces in turbine housing.

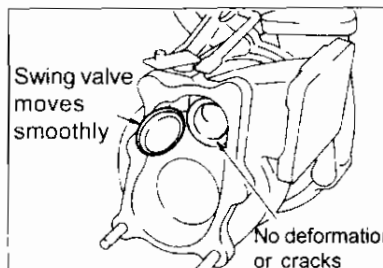

**[Point 4] Rotor shaft play inspection**

- Position the dial gauge and measure play and thrust clearance.

**Rotor shaft play (mm):** 0.084 ~ 0.107

**Thrust clearance (mm):** 0.045 ~ 0.140

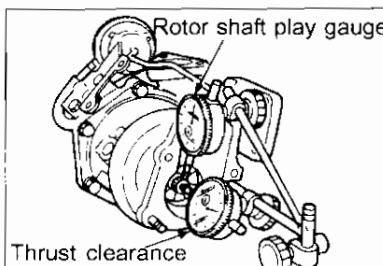



## RB20DET ENGINE

**[Point 5] Compressor wheel inspection**

- Oil must not adhere to suction inlet.
- There must be no interference with compressor housing.
- Wheel must not be bent, folded or otherwise damaged.

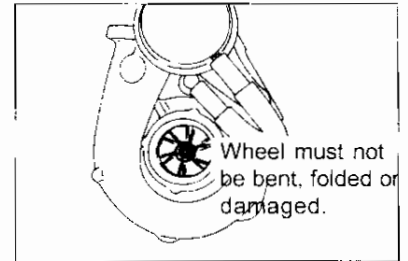
**[Point 6] Rotor shaft inspection**

- There must be no carbon sledge accumulation.

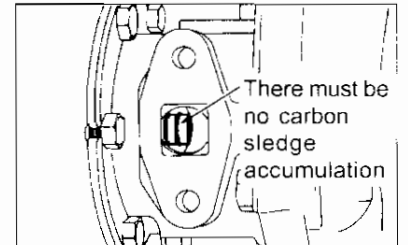
**[Point 7] Swing valve controller inspection**

- Remove the swing valve controller rubber hose on the compressor housing side.
- Check the swing valve controller whenever the actuator rod is installed or removed.
- Use the air gun to blow compressed air approx. 0.8 ~ 0.9 kg/cm<sup>2</sup> into hose and make sure the swing valve controller rod operates. Stop blowing air as soon as the rod operates.

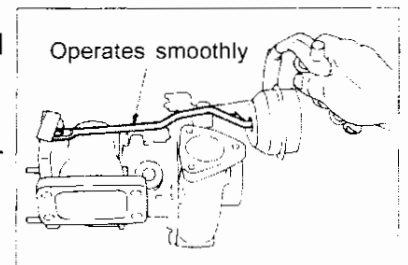
**Caution:**

Make sure to verify the air gun pressure using the LPG pressure gauge before testing the air hose. If air pressure is applied excessively the diaphragm may be damaged.

**[Point 8] Oil and cooling water inlet and outlet cleaning**

- Use engine conditioner to clean the oil feed and return passages.
- Use radiator cleaner to clean cooling water feed and return passages.
- Clean using the air gun.
- Clean the compressor wheel, turbine wheel, compressor housing and turbine housing with same methods.

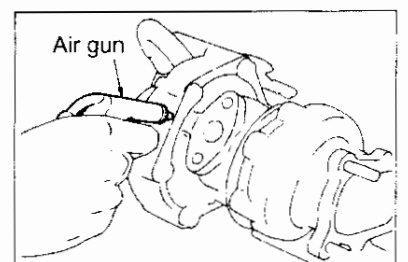
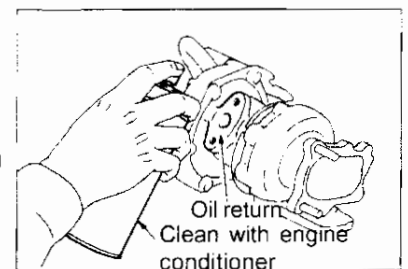

**(3) Turbocharger failure diagnosis (Oil leaks, smoke (white or blue smoke), lack of power, poor acceleration, abnormal noise)**

Points to be checked before diagnosis:

1. The engine oil level must be between the MIN and the MAX marks on the oil level gauge. (When the engine oil level is higher than MAX line, the engine oil will flow into the intake duct through the blowby gas recirculation pass and the turbocharger may be determined to be malfunctioning).
2. Check with customer to determine if oil is cooled when idling after driving.  
If any malfunction in the following chart is detected in a unit inspection, replace the turbocharger ASSY.

Inspection location	Inspection result	Possible associated phenomenon			
		Oil leak	Smoke	Abnormal noise	Lack of power / Poor acceleration
Turbine rotor	Oil on rotors	△	◎	△	△
	Carbon has accumulated	△	◎	○	○
	Rotor scrapes against the housing	△	○	◎	○
	Turbine vanes are bent or folded			◎	◎
Compressor wheel	Suction inlet is dirty with oil	○	○		
	Rotor scrapes against the housing	△	○	◎	○
	Turbine vanes are bent or folded			◎	◎
Turbine and compressor Rotor shaft play inspection	There is resistance or scraping when rotated by finger		△	△	○
	Rotation by finger is not possible				◎
	Considerable shaking between rotor shaft and turbo ASSY	△	△	○	△
Look through oil hole (inspect interior with pen light)	Carbon sludge has accumulated in waste oil hole	△	◎	△	△
Swing valve operation (use air gun or air pump)	The valve does not move smoothly when pressure is applied gradually. (usually opens at pressure greater than 0.6 ~ 0.7 kg/cm <sup>2</sup> )				◎

◎ Highly possible    ○ Possible    △ Slightly possible

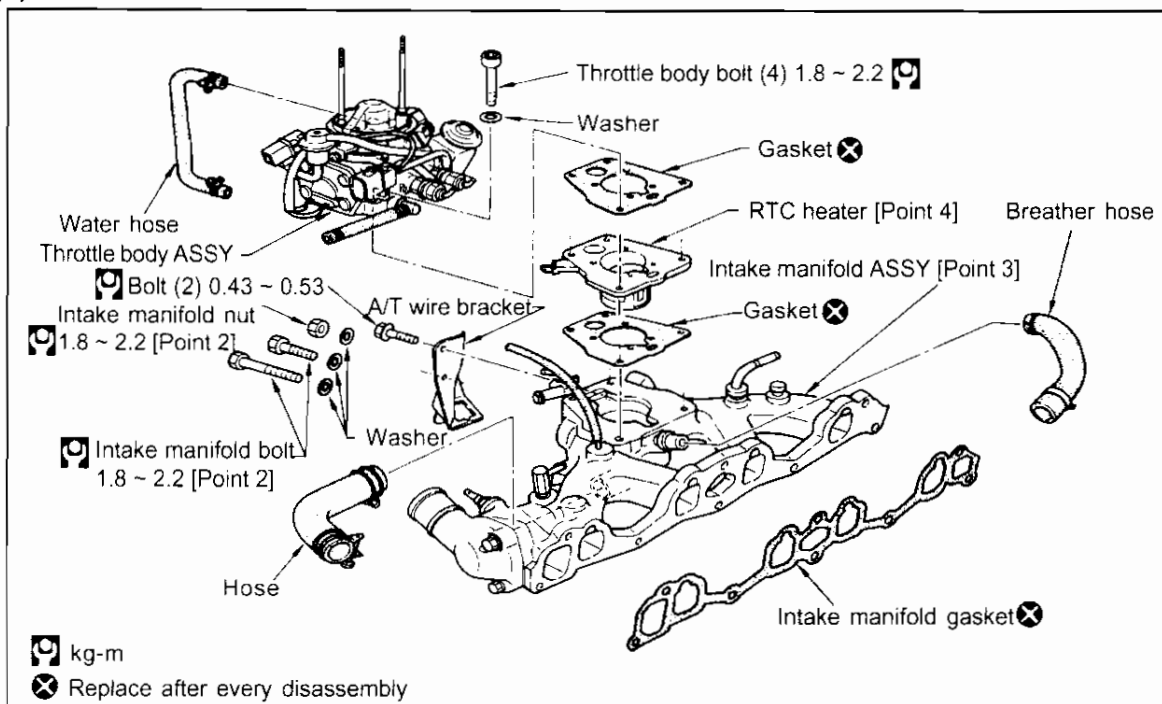
**10.1 INTAKE MANIFOLD ASSY****(1) Remove & instal intake manifold ASSY****Additional work required:**

- Release fuel pressure in the fuel lines
- Drain and refill cooling water
- Air cleaner ASSY
- Fuel hose
- Water hose
- Intake side high-tension cable
- Vacuum hoses and ECCS harness connectors
- Acceleration wire [Point 1]
- Water temperature sensor connector
- Thermal transmitter connector

**[Point 1] Acceleration wire adjustment**

- Loosen lock nut to provide adequate slack for the accelerator wire and pull out case in the direction of the accelerator. Return the lock nut 1.0 ~ 1.5 turns from the position the throttle drum starts moving (when there is no play in cable) and tighten.

**Tightening torque (kg-m): 0.8 ~ 1.0**

**[Point 2] Remove & install intake manifold**

- Removal is the reverse of installation sequence shown in the figure on the right.
- The installation sequence is shown in the figure.

**Note:**

Never reuse the gasket.

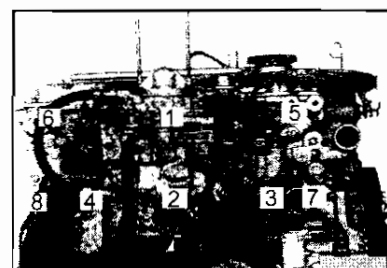

**[Point 3] Intake manifold inspection**

- Measure the intake manifold surface for distortions in four separate directions (at opposite directions; horizontally and vertically) in a number of locations.

**Limit value (mm): 0.15**

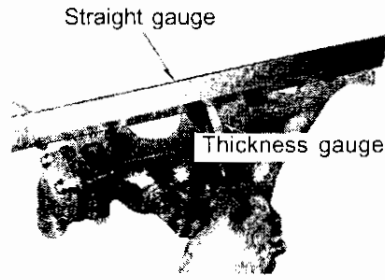

**[Point 4] PTC heater inspection**

- Make sure there is no crack on the PTC heater.

**(2) Disassemble & assemble throttle body ASSY**

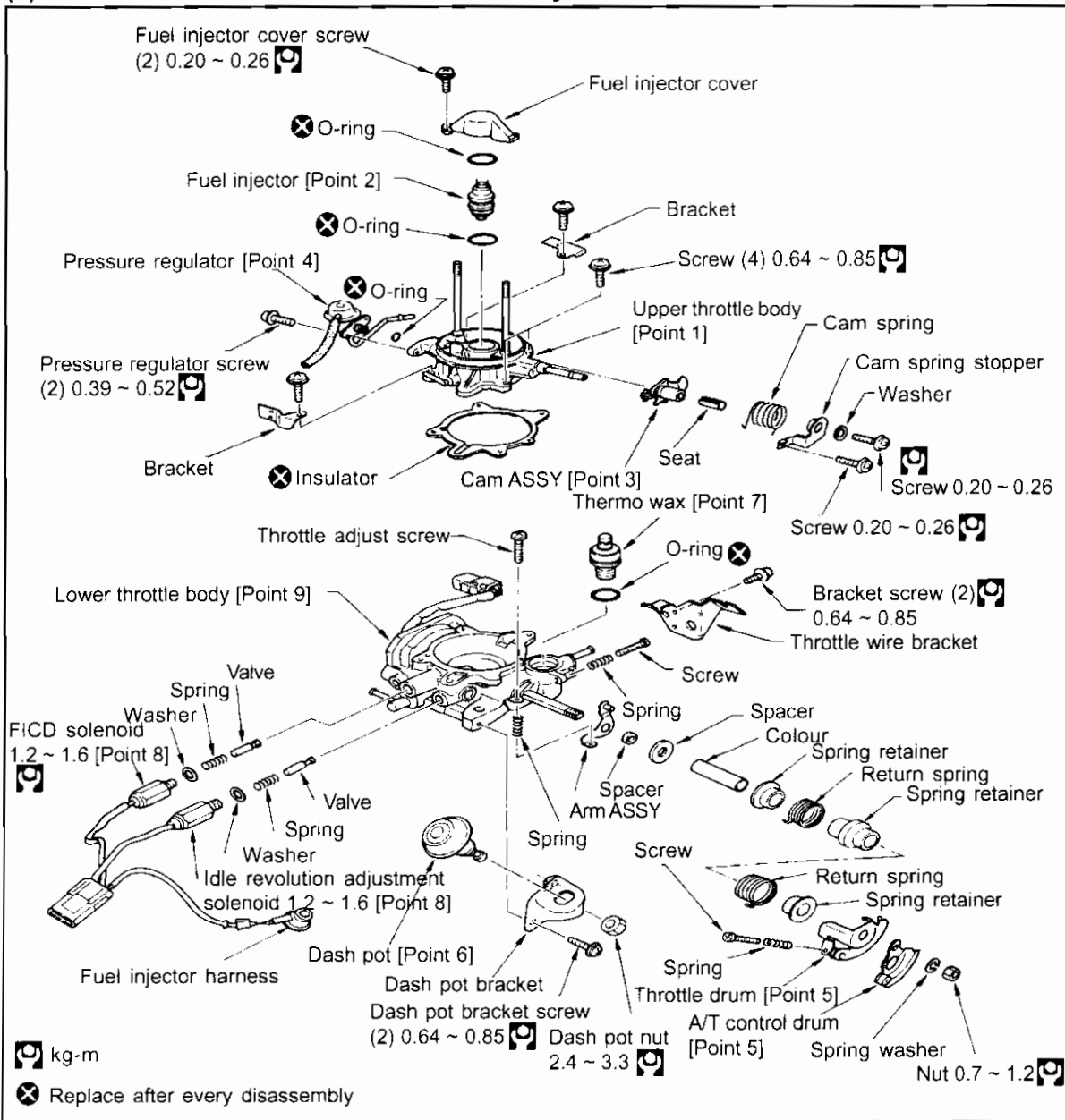

**Remove & install throttle body ASSY**

- First remove four throttle body bolts to remove throttle body ASSY.
- After the installation check the tightening torque.  
**Bolt tightening torque (kg-m):** 1.8 ~ 2.2
- Always replace gasket with new ones.

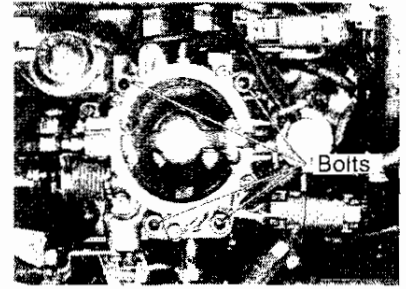
**[Point 1] Remove upper throttle body**

- First remove the fuel injector cover then separate the fuel injector connector.
- Loosen four upper throttle body screws to remove.

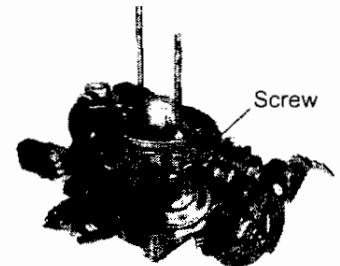
**[Point 2] Fuel injector Removal**

- First remove the injector cover to remove upper O-ring, then extract fuel injector.
- Care must be taken not to scratch or damage the fuel injector and throttle body seal surface.

**Cautions when handling O-ring**

- Never reuse O-rings.
- Coat the O-ring with engine oil (7.5 W - 30 or equivalent) but do not apply solvent to them as this may remove the oil coating.
- Do not allow dirt, dust or foreign objects to adhere to O-rings or other equipment surfaces.
- Care must be taken not to scratch, twist or stretch O-rings when installing. Do not insert it in the fuel tube by making it stretch slightly.
- Do not store O-rings in location subject to ozone, high temperature or in direct sunlight.

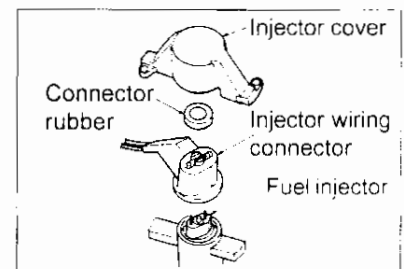
**Installation**

- Replace both upper and lower O-rings to new ones.
- Coat the lower O-ring with engine oil and install to throttle body.
- Place the fuel injector inside the throttle body and set the injector position by placing the injector connector and the injector cover.
- Use oil seal drift to insert the fuel injector (resistance must be felt).
- Coat the upper O-ring with engine oil. Use oil seal drift to insert the O-ring.

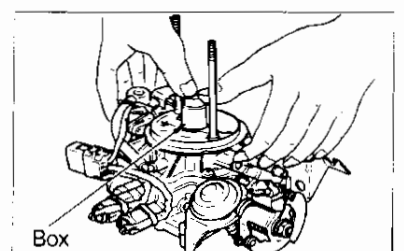
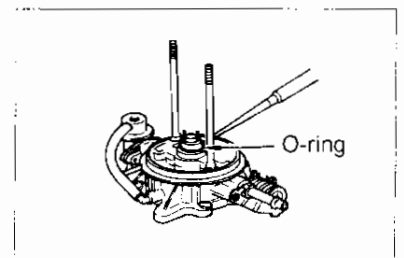

**[Point 3] Cam ASSY****Removal**

- Remove the cam ASSY from the upper throttle body.

**Caution:**

Extra care must be taken as there are tension on the cam spring.

**Inspection**

- Look for any deformation or wear on the cam spring.

**Cap spring free length (mm): 24.5 ~ 26.5**

**Installation**

- Make sure to install the cam ASSY and the cam spring in right direction.
- Replace the seat with new ones.

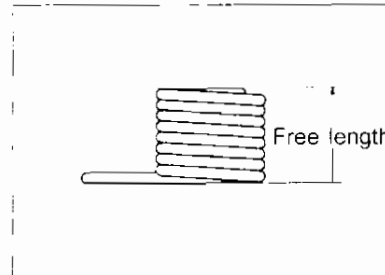
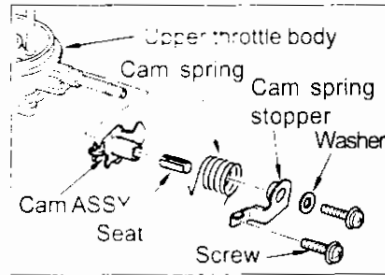
**[Point 4] Pressure regulator****Removal**

- Remove the pressure regulator from the upper throttle body.
- Carry out the fuel pressure inspection.

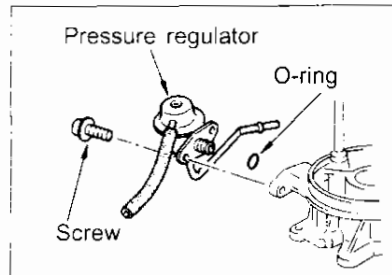
**[Point 5] Throttle drum & A / T control drum****Removal**

- First remove the nuts and remove the A / T control drum.
- Remove throttle adjust screw and return spring and remove the throttle drum from the lower throttle body.

**Inspection**

- Inspect visually if there are any warn, cracks or deformation on spring retainer, retainer, and colour. Also inspect rotation contact surface.
- Check deformation and warn on the throttle adjustment screw and return spring.

**Return spring free length (mm): 19.5 ~ 21.5**

**Installation**

- Care must be taken to install the parts in correct direction when installing the arm ASSY, return spring, throttle drum and A/T control drum.

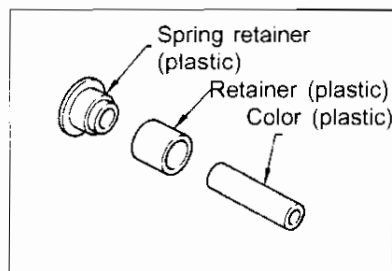
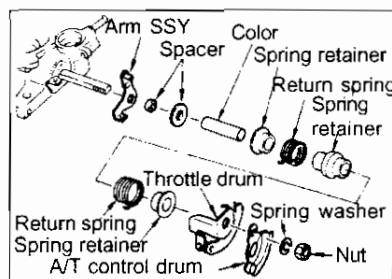

**[Point 6] Remove dashpot**

- First remove the dashpot bracket to remove the dashpot.

**Inspection**

- Check visually for any deformation or cracks on the rubber part.

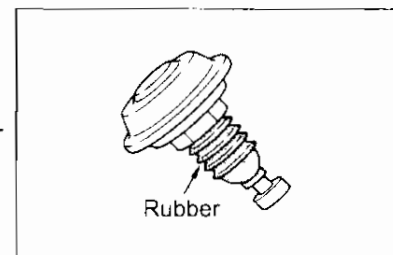
**[Point 7] Remove thermos wax**

- First remove the throttle wire bracket to remove thermo wax.

**Inspection**

- Check if the pin will extend when the thermo wax is warmed.

**Caution:**

Do not pull out the pin.

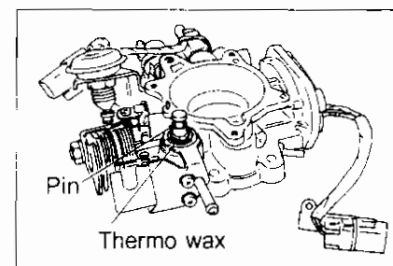
**[Point 8] FICD solenoid & Idle revolution adjustment solenoid****Removal**

- Remove FICD solenoid and idle up solenoid from lower throttle body.

**Caution:**

Watch out for spring and the valve as it may jump out.

**Inspection**

- Check that no worn or foreign matter adheres to valve head.
- Check the spring for deformation or wear.

**Spring free length (mm): 11 ~ 12**

**Installation**

- Check the orientation of the valve when installing.

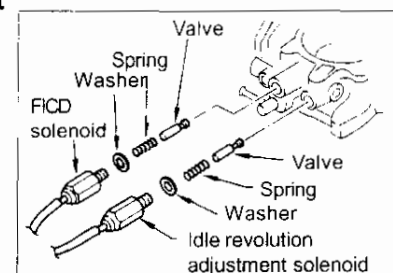
**[Point 9] Lower throttle body inspection**

- Check for any clogging in the air passage by carrying out air blow inspection.
- Check for any cracks on lower throttle body.

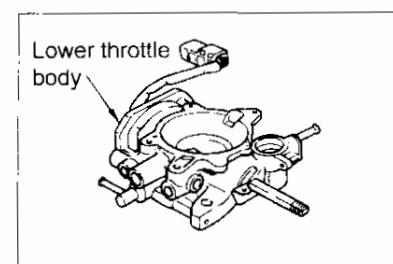

## 10-2 EXHAUST MANIFOLD ASSY

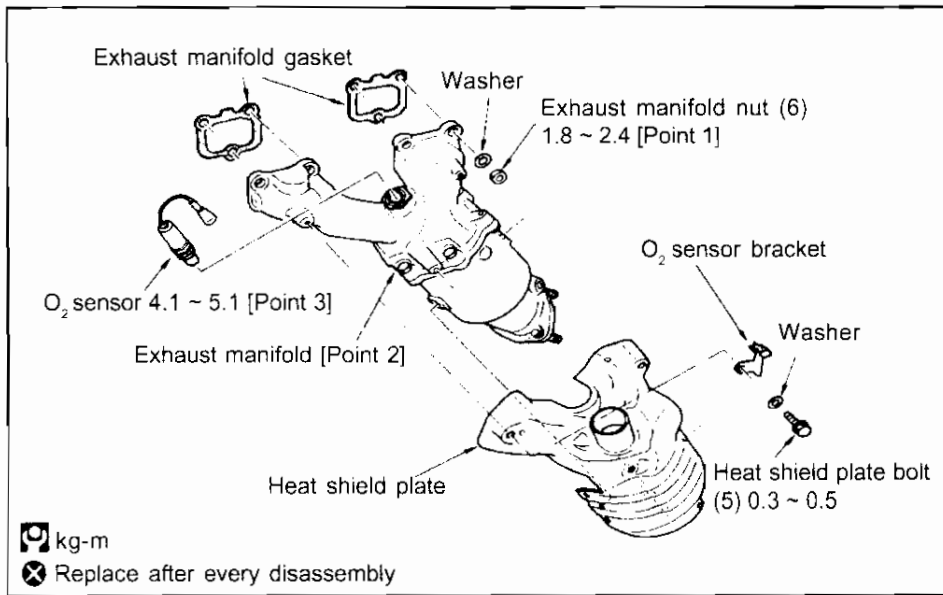
**Additional work required:**

- Under cover
- Exhaust front tube nuts
- O<sub>2</sub> sensor connector
- Exhaust temperature sensor
- Hot air duct

**[Point 1] Remove & install exhaust manifold**

- Removal**
- Removal is the reverse of installation sequence shown in the figure.

**Installation**

- The installation sequence is shown in the figure on right.
- Check the standard tightening torque after installation.

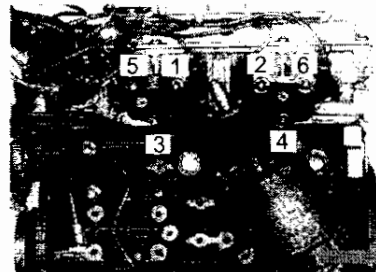
**[Point 2] Exhaust manifold inspection**

- Measure the exhaust manifold surface for distortions in four separate directions (opposite directions: horizontally and vertically) in a number of locations).

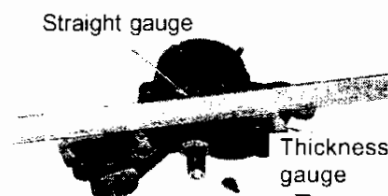
**[Point 3] Remove & install O<sub>2</sub> sensor**  
(Zirconium type single pole connector)

- Do not use tools with impact such as impact wrench for removal and installation of the O<sub>2</sub> sensor.

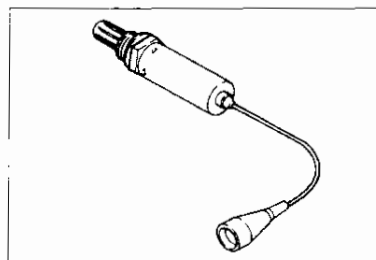

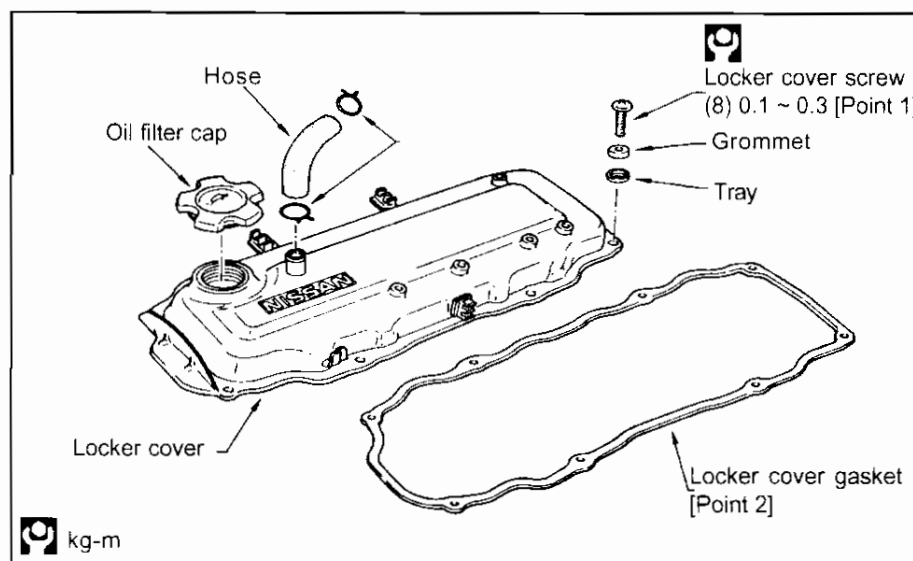

## 10-3 LOCKER COVER

**Additional work required:**

- High-tension cable
- Air cleaner ASSY

**[Point 1] Remove & install locker cover****Removal**

- Removal is the reverse order of installation sequence shown in the figure on right.

**Installation**

- The installation sequence is shown in the figure on right.
- When removing and installing the locker cover, also remove the cover gasket and wipe off the oil adhere on the gasket and in the groove.

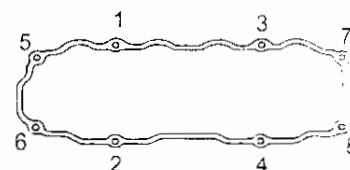
**[Point 2] Locker cover gasket**

- Make sure the rocker cover gasket is positioned securely in groove without twisting.

**10-4 TIMING BELT (CRANK PULLEY, BELT COVER)**  
**(1) Remove & install timing belt cover**

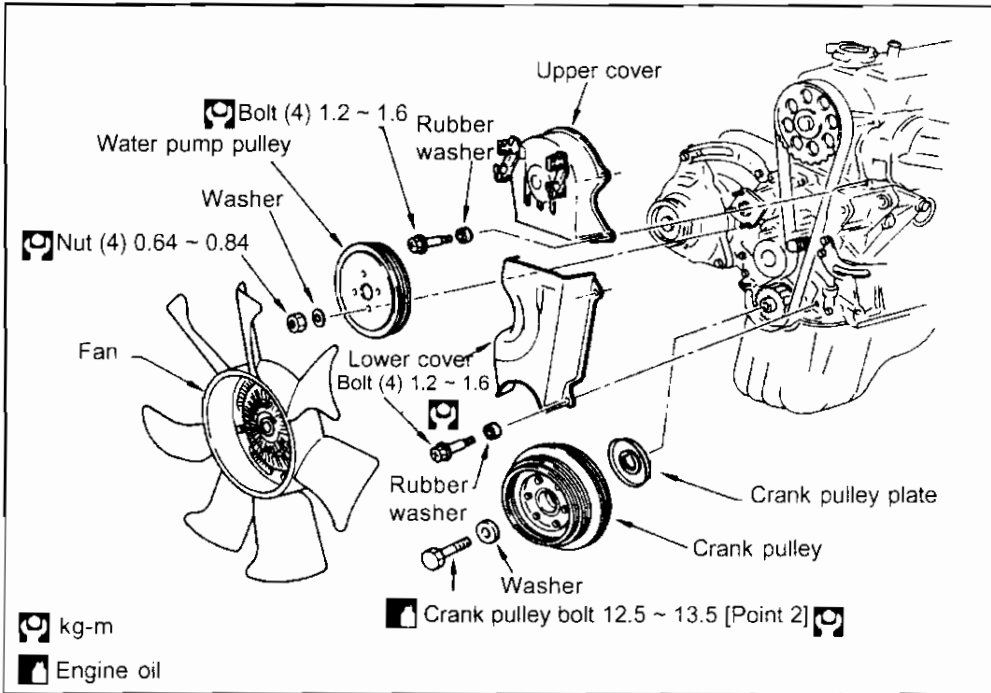

**Additional work required:**

- Under cover
- Fan shroud
- Supplement belts
- Spark plug
- No. 1 cylinder compression T.D.C position [Point 1]
- Install ring gear stopper [Point 2]

**[Point 1] No. 1 cylinder compression D.T.C inspection**

- Align the crank pulley mark and the belt cover timing indicator to compression T.D.C.
- No. 1 cylinder is at compression stroke top dead center when both the intake and exhaust side cams do not move the valve lifters.

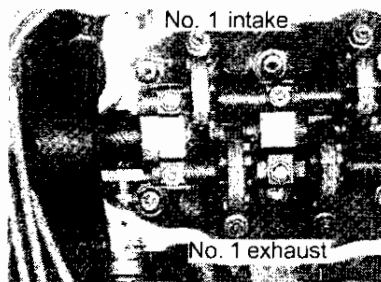
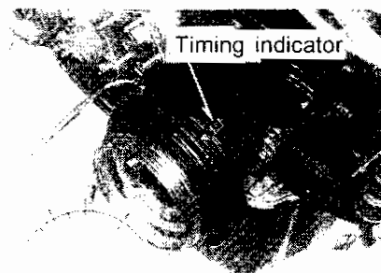

**[Point 2] Remove & install crank pulley bolts**

- Remove starter motor and attach ring gear stopper.

**Caution:**

Coat the screw part with engine oil when tightening the crank pulley bolt.

Do not apply any oil on the damper area when installing or removing the crank pulley.

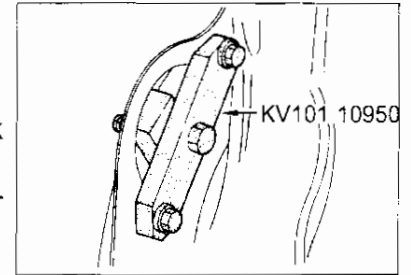

**[Point 3] Remove crank pulley**

- Loosen the crank pulley bolts and use pulley puller (steering wheel puller ST2718 0001) to remove the crank pulley.

**Caution:**

Do not hook the pulley puller on the crank pulley groove.

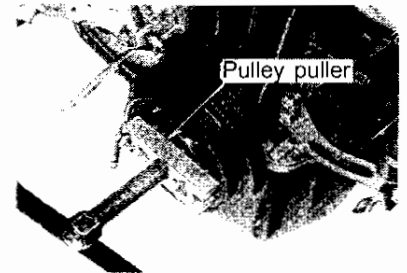

**[Point 4] Remove & install belt cover**

- Do not scratch packing when removing and installing the belt cover.
- Always tighten the belt cover bolt using the rubber washer.

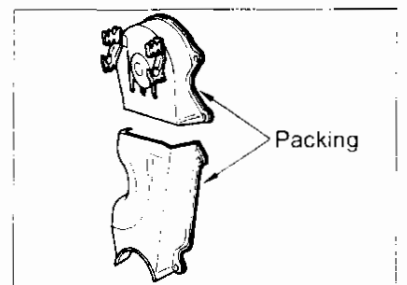

**[Point 5] Install crank pulley plate**

- Make sure the crank pulley plate is positioned in correct way.

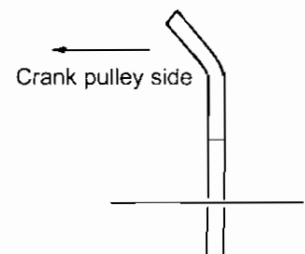

**(2) Remove & install timing belt**

**Timing belt alignment mark verification and installation**

- If paint on upper belt is unclear when disassembly is performed, paint a mark on belt that indicates rotation direction.
- Position the alignment mark of the cam pulleys with respective timing belt cover alignment marks. (No. 1 cylinder at T.D.C)
- Install the timing belt so the number of ridges from the alignment mark to crank pulley (inner) alignment mark will be as indicated below.

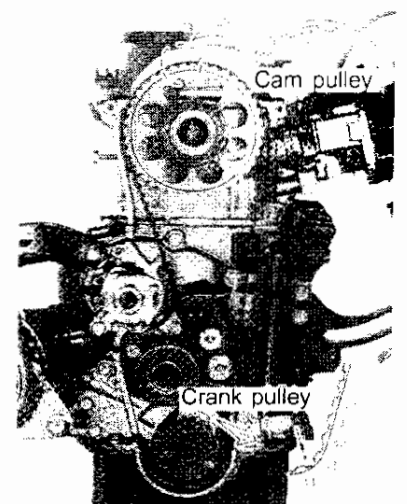

	No. of ridges between two marks	Total No. of ridges
CA18i	43	95

**Timing belt tension adjustment**

- Remove spark plug and tighten tensioner bolt (1 & 2) temporarily.
- Hook the tensioner spring (3) on the lower bolt (2).
- Hook the spring on the hook (4) and tighten the bolt (1).
- Loosen the tensioner (5) and tighten the bolt (2).

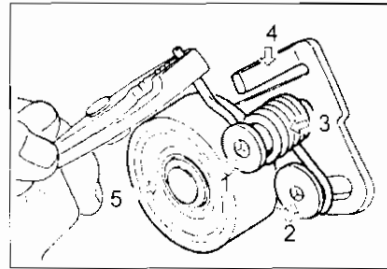

**Caution:**

- Make sure the spring is positioned correctly at this stage.
- Check if the tensioner (5) will rotate when pushed by finger.
  - Align the timing belt alignment mark and the pulley alignment mark to install the timing belt.
  - Loosen the tensioner bolt (2).
  - Turn the cam pulley more than two turns clockwise to check belt movement and stop slowly at No. 1 cylinder compression T.D.C point.
  - Tighten tensioner bolts (1 & 2).

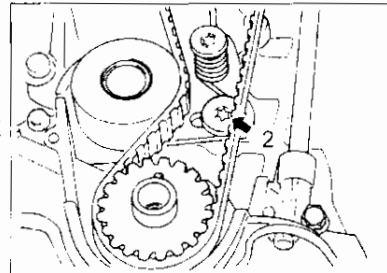

**Tightening torque (kg-m):** 1.5 ~ 2.0

**(3) Timing belt inspection**

Replace timing belt if inspection indicates any problem.

Item	Condition	Cause
Tooth missing Cracked tooth		Camshaft lock Crank sensor lock
Cracks on rear side		Tensioner lock Engine overheat Interference with belt cover etc.
Wear and cracks on the side		Belt misalignment Belt plate malfunction
Worn teeth		Sliding motion resistance in crank sensor and the camshaft
Oil or water adhesion		Oil seal malfunction Water leaks in water pump

**Caution:**

- (1) Make sure the timing belt is not twisted or bent sharply.  
Make sure there is no oil film or water on the belt.
- (2) Timing belt need to be replaced every 100,000 km.

## 10-5 WATER PUMP

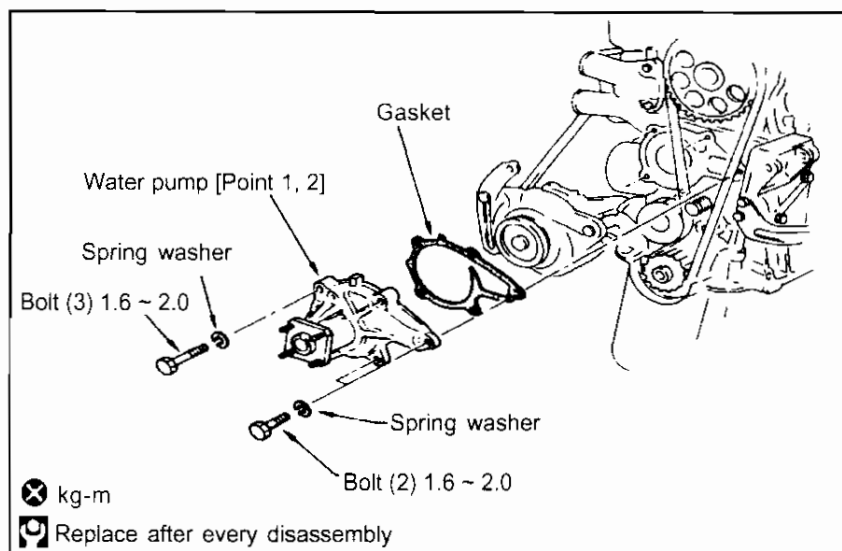
**Additional work required:**

- Drain and refill cooling water
- Fan shroud
- Fan
- Water pump pulley
- Supplementary belts
- Timing belt cover

**[Point 1] Remove water pump**

- Be careful not to get coolant on timing belt. If any water does spill, wipe it off immediately.

**Caution:**

Remove old gasket on the water pump surface using the scraper.

**[Point 2] Water pump inspection**

- Rotate water pump by hand and check for any abnormal sound and smooth operation.
- There must be no traces of water leaks.

10-6 THERMOSTAT

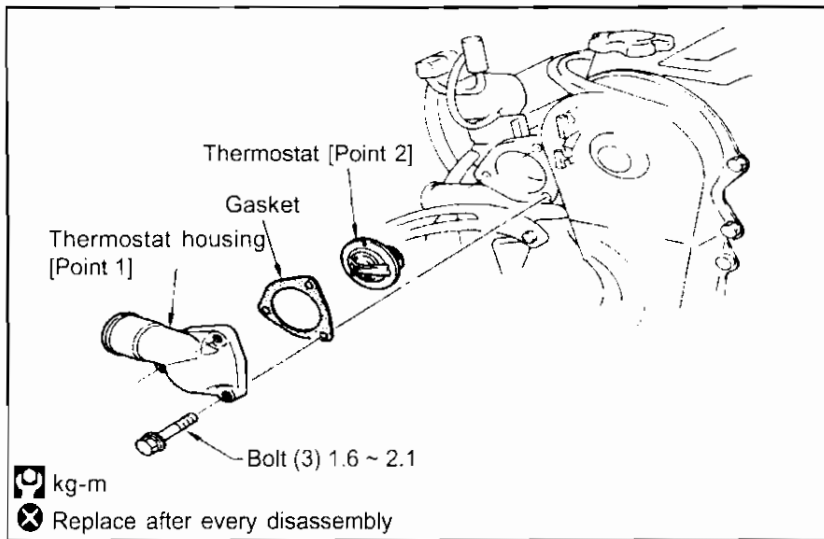

**Additional work required:**

- Drain and refill cooling water
- Water outlet hose

**[Point 1] Remove & install thermostat housing**

**Removal**

- Insert screwdriver handle into thermostat housing. Pry lightly up and down and remove housing.

**Installation**

- Place the jiggle valve on top when installing the thermostat housing.

**Caution:**

Remove old gasket on the water outlet surface using the scraper.

**[Point 2] Thermostat inspection**

- Check the valve opening temperature and maximum valve lift.
- Hang the thermostat by string in valve and submerge in heated water in double walled container and stir water while heating it up.
- The opening temperature is the temperature when the valve opens and thermostat falls from string.

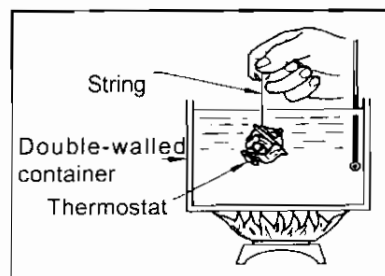

	Standard climate	Cold climate
Valve opening temperature (°C)	82	88
Max. valve lift (min / °C)	Over 8 / 95	Over 7 / 100

**10.7 OIL PAN & OIL FILTER**

**(1) Remove & install oil pan**

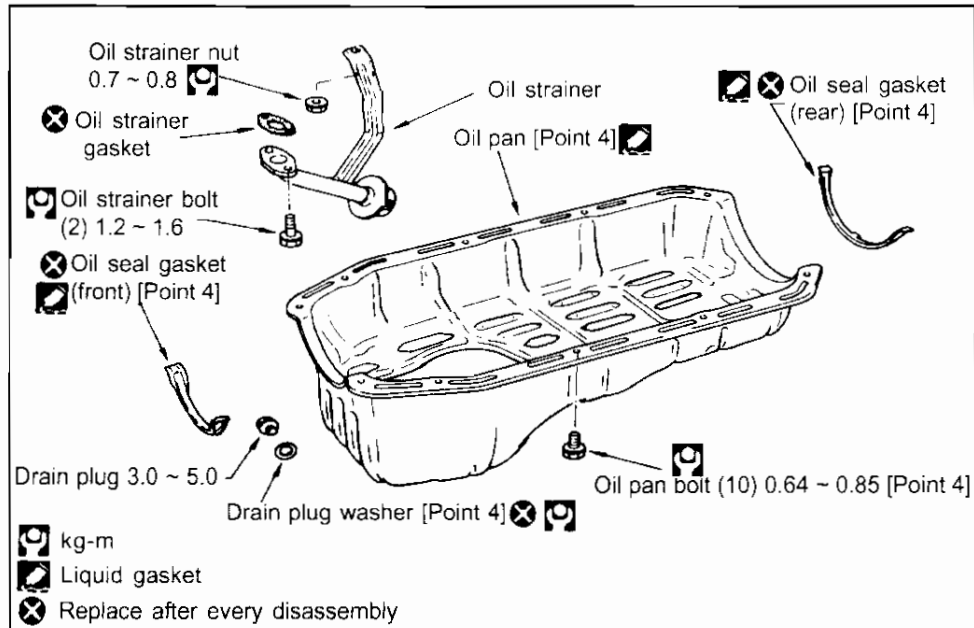

**Additional work required:**

- Under cover
- Engine oil
- Right & left engine gusset

**[Point 1] Drain plug washer**

- The drain plug washer has installation direction, make sure to install in the correct direction.
- Always replace drain plug with new ones when removing and installing.

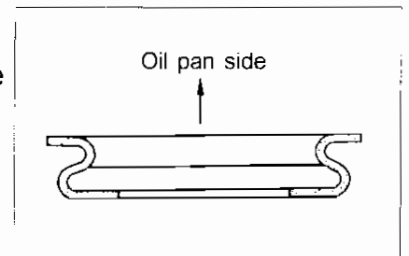

**[Point 2] Remove & install oil pan bolt**

**Removal**

- Remove the bolts in reverse sequence shown in figure on right.

**Installation**

- Install bolts in sequence shown in the figure on right.
- Tighten bolts to correct tightening torque.

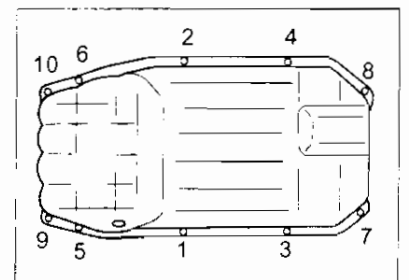

**[Point 3] Remove and install oil pan**

**Removal**

- Remove the oil pan using the seal cutter (KV101 11100).

**Caution:**

Remove old liquid gasket on the block pan flange groove using a scraper.

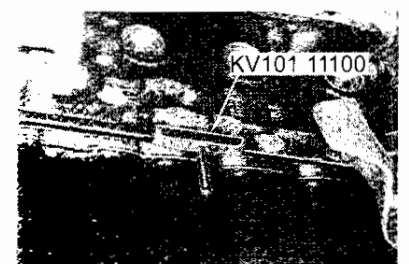

CA18i ENGINE

**Installation**

- Apply sealing agent (SS60F or equivalent) on the areas shown in the figure on right to install oil pan gasket.

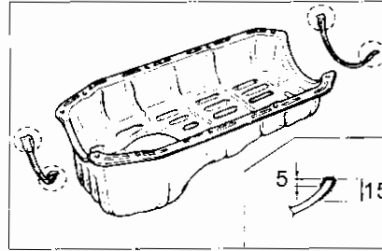

- Apply a continuous bead of liquid gasket (KP510 00150) to sealing surface using the tube presser and install the oil pan within 5 minutes after coating.

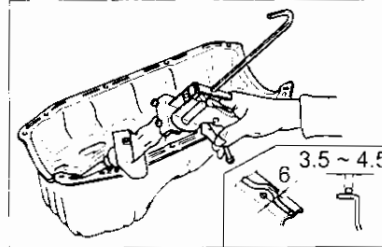

- Insert two center bolts to oil pan bolt holes, make sure it is fitted correctly then tighten.

Caution:

Leave for 30 minutes after the installation.

**[Point 4] Oil leak & oil pressure inspection**

- Warm up the engine and check for any oil leaking and the oil pressure.
- Release the oil pressure switch and install the oil pressure gauge when carrying out the oil pressure inspection.

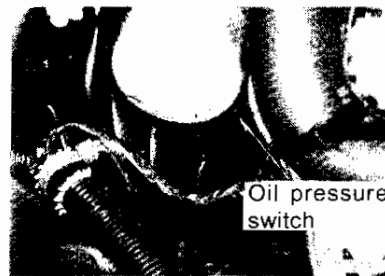

<b>Engine revolution (rpm)</b>	When idling	2000	4000
<b>Exhaust output (kg / cm<sup>2</sup>)</b>	Approx. 1	Approx. 3	Approx. 4

**(2) Remove & install oil filter**

**Removal**

- Use oil filter wrench to remove the oil filter.

**Installation**

- Before installing the oil filter, wipe off dust, etc. from oil cylinder block surface. Apply a thin coat of engine oil to new oil filter O-ring.
- Screw oil filter by hand until it hit the cylinder block, then tighten an additional 2 / 3 turn with oil filter wrench. After tightening, start the engine and check for oil leaks.

**Tightening torque (kg-m): 1.5 ~ 2.1**

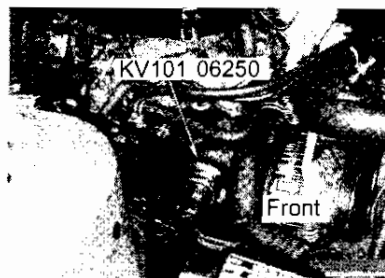





## RB25DE ENGINE

- Put alignment mark on each air hoses and the duct then remove.
- Remove 4 clips on air cleaner case (1 on upper case 3 on lower case).
- Remove upper case to extract air cleaner element.
- Remove the lower case by first removing 4 bolts.

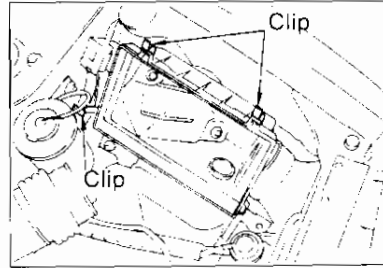

- Remove the resonator by first removing the left fender protector then loosening the resonator bolt.

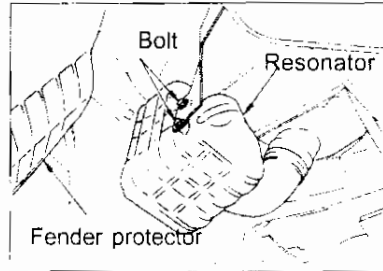

- Remove the air duct by first removing the front combination lamp and the left head lamp ASSY.
- Care must be taken not to scratch or damage the airflow meter sensor when removing the airflow meter.

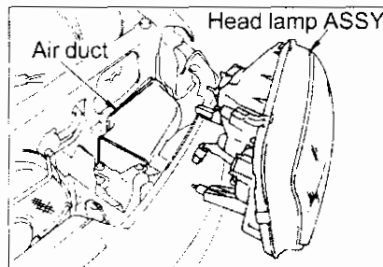
**Installation**

- Installation of the air duct and the air cleaner is carried out in reverse order of removal operation.
- Air flow meter circuit case is nonseparable, use ASSY when replacing the air flow meter.
- Make sure to insert the air hose and the air duct securely by aligning the alignment mark correctly and tighten the band and the clamp.

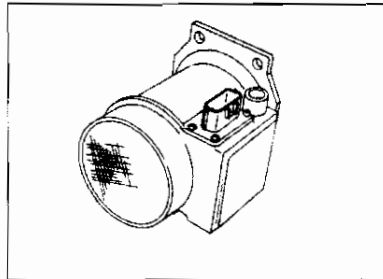

**10-2 INTAKE MANIFOLD COLLECTOR**  
**(1) Remove & install intake manifold collector**

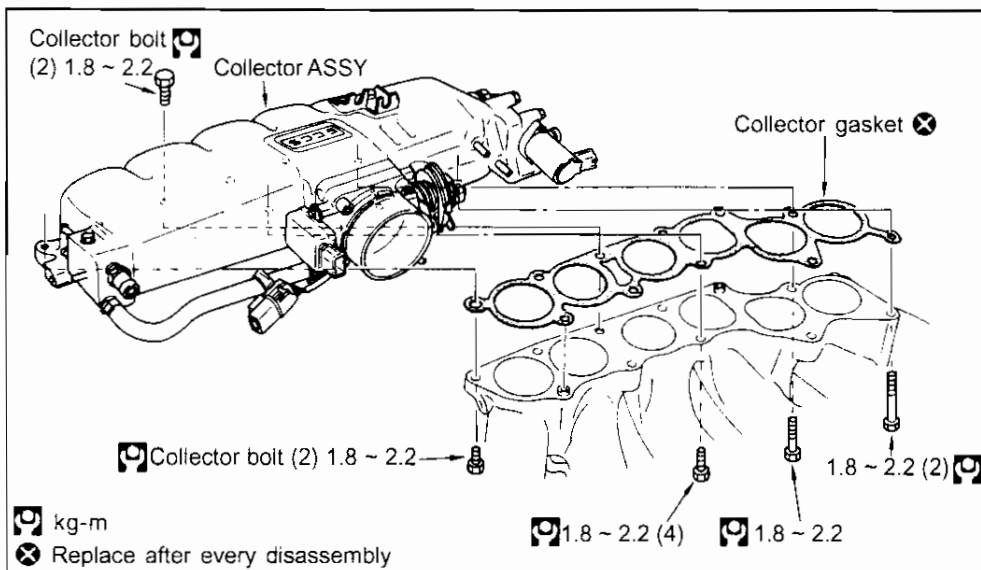

**Removal**

**Release the fuel pressure**

- Warm up the engine.
- Select 'Fuel pump relay' in 'Active test' mode.
- Select 'cancel' to release the fuel pressure.
- Crank 2 ~ 3 times to consume the fuel left in the piping.

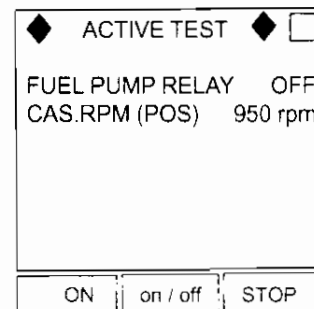

- After starting the engine remove the fuel pump fuse.
- After the engine stops, crank the engine over two or three times to consume the fuel left in the pipe.
- If the engine does not start, remove the pump fuse and crank the engine three to four times to consume the fuel left in the pipe.

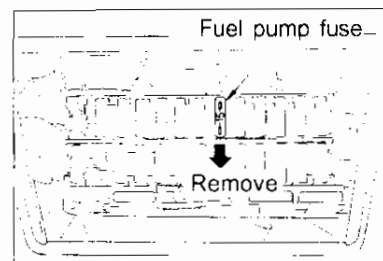

**Caution:**

The battery may become weak easily, use booster cables to connect it to charged battery if necessary.

- Remove the negative terminal from the battery.
- Drain cooling water from the radiator drain plug.
- Remove accelerator wire.
- Remove the AAC valve connector, FICD connector and the vehicle body ground cable.

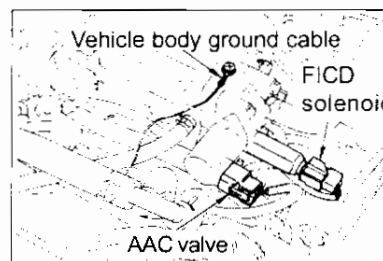

- Remove the hose A between the brake booster and the collector.
- Remove the hose B between IAA unit and the fuel damper.
- Remove the hose C between canister and the collector.
- Remove the hose D between canister and the throttle chamber.

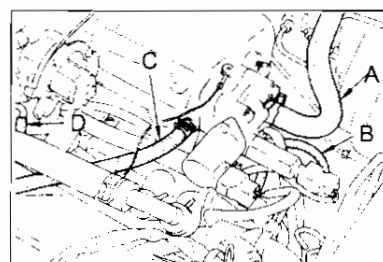

RB25DE ENGINE

- Remove blowby hose E between locker cover and the collector.
- Remove hose F between pressure regulator and the collector.
- Remove three water hoses G.
- Remove the hose between air regulator and the collector. Lift up the collector ASSY when removing the hose for easier operation.
- Remove fuel feed and return hose H, then remove the clamp from the collector.
- Loosen the hose clamp to remove collector ASSY.

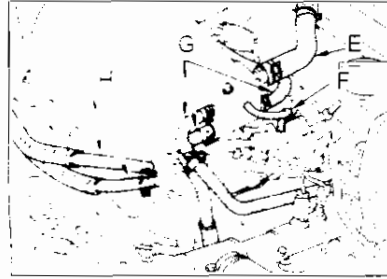

- Loosen the bolts in order shown in the figure on right.
- Check to see every hoses required are removed.

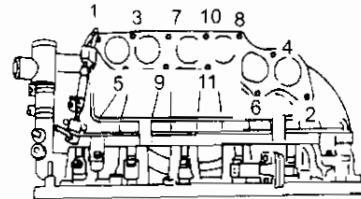

- Remove collector gasket.
- Use a tool such as a scraper to remove any left over gasket on the surface.

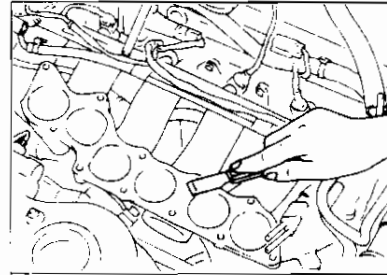

**Installation**

- Install the collector gasket.
- Make sure there is no dust, oil or other foreign matter is on the sealing surface.
- Install the collector ASSY.
- Tighten the bolts in the order shown in the figure on right. Tighten in gradual steps to uniform tightness.

Installation location	Length (mm) : No. of bolts	Tightening torque (kg-m)
7, 10	105 : 2	1.8 ~ 2.2
8	65 : 1	1.8 ~ 2.2
1, 3, 4, 6	40 : 4	1.8 ~ 2.2
2, 5, 9, 11	30 : 4	1.8 ~ 2.2

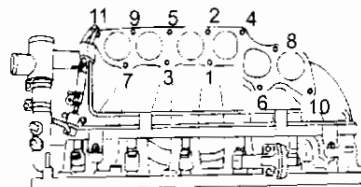

- Connect each wiring and the piping in the reverse order of the removal operation.
- Connect the accelerator wire.
- Provide adequate slack for the accelerator wire and pull outer case in the direction of the accelerator using the adjust nut. Return lock nut 1.0 to 1.5 turns from the position the throttle drum starts moving (when there is no play) and tighten.

**Tightening torque (kg-m):**                      **0.8 ~ 1.0**

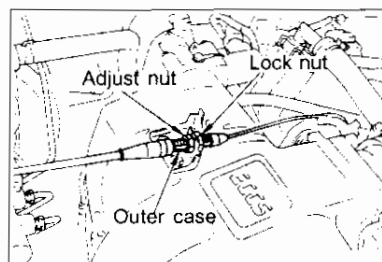

- Make sure the radiator drain plug is closed securely and refill the cooling water from the feed opening.
- Release the air using the air release plug after refilling the cooling water to prevent overheat.

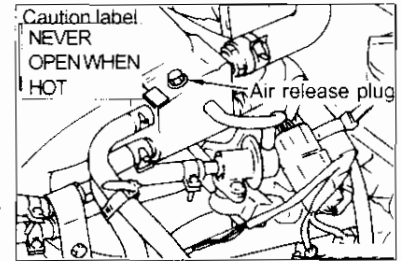

**Caution:**

Do not remove the air release plug when the engine is warm.  
Do not over tighten the air release plug bolt.

**(2) Disassemble & assemble intake manifold collector**

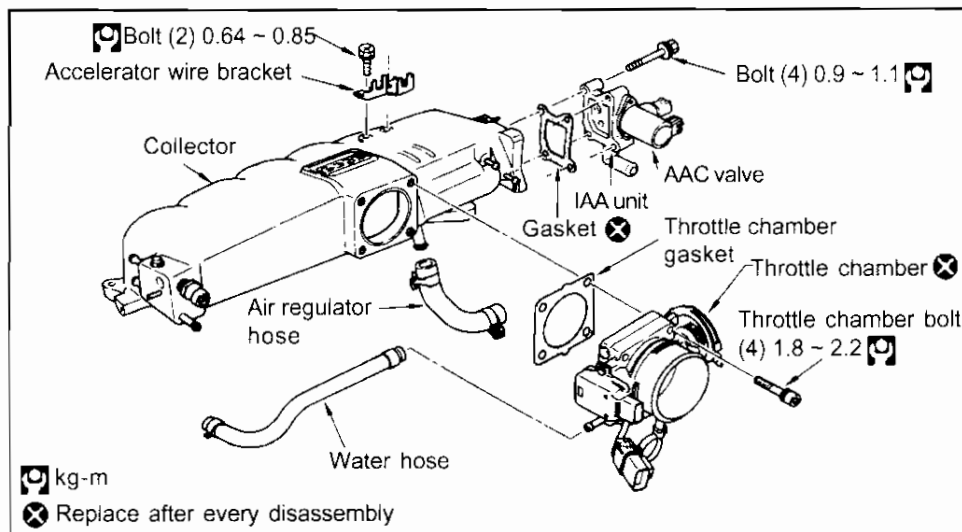

**Disassembly**

- Remove throttle chamber
- Remove IAA unit

**Assembly**

- Install throttle chamber gasket

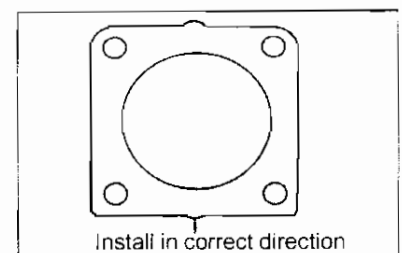

- Tighten the throttle chamber bolts in order shown in figure on right uniformly in two stages.

**Tightening torque (kg-m):**      **First stage**    0.9 ~ 1.1  
    **Second stage** 1.8 ~ 2.2

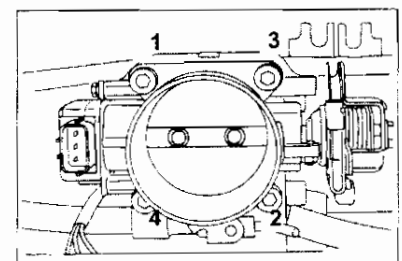

- Install IAA unit.

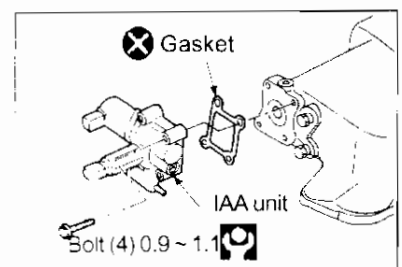

## 10-3 FUEL INJECTOR

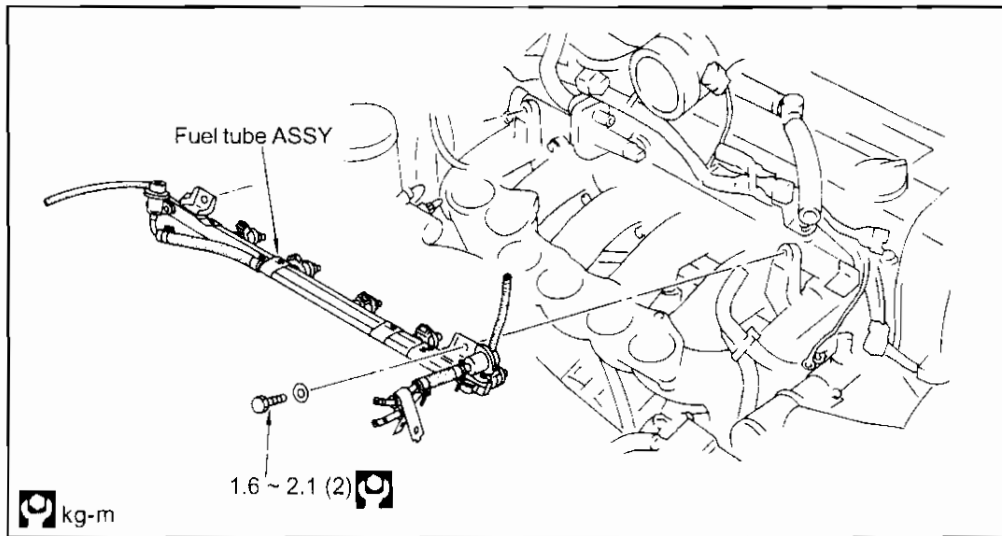
**Removal**

- Remove collector ASSY. For detailed removal process refer to "Collector" section.
- Remove fuel injector connector and the lamp.
- Remove the connector pin.
- The operation can be carried out easily if the vehicle body ground wires, water temperature sensor connector and the thermal transmitter connector are removed.
- Remove air regulator connector.
- Remove the fuel ASSY by first removing the bolts.
- Replace o-ring with new ones when removing fuel injector, pressure regulator and fuel bumper from the fuel tube.
- Do not pull the connector parts when removing the fuel injector.

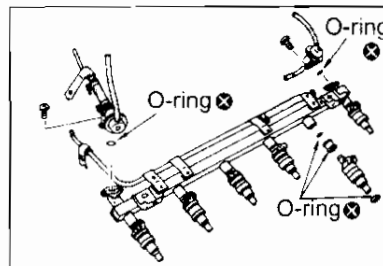
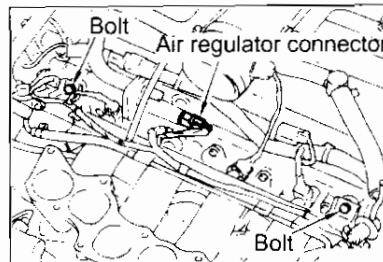
**Precautions when handling O-ring**

- Coat the O-ring with engine oil (7.5W -30 or equivalent) but do not apply solvent as this may remove the oil coating.
- Avoid using dirty O-rings and do not allow dirt, dust or foreign objects to adhere to O-rings or other equipment surfaces.
- Care must be taken not to scratch, twist or stretch them by tools or operator's fingernails when installing O-rings.

**Inspection**

- Fuel injector resistance  
Resistance value ( $\Omega$ ): Approx. 13 ~ 14
- Injector can not be disassembled.

**Installation**

- Do not rotate or decenter the parts when installing the fuel injector, pressure regulator and fuel bumper to the fuel tube.
- Tighten the pressure regulator and the fuel bumper screws uniformly in two to three stages.

**Tightening torque (kg-m):** 0.30 ~ 0.39

- Install fuel tube ASSY

**Tightening torque (kg-m):** 1.6 ~ 2.1

- Connect the air regulator connector.
- Install the fuel injector connector and fix it in place using the clamp.
- Install the collector ASSY.

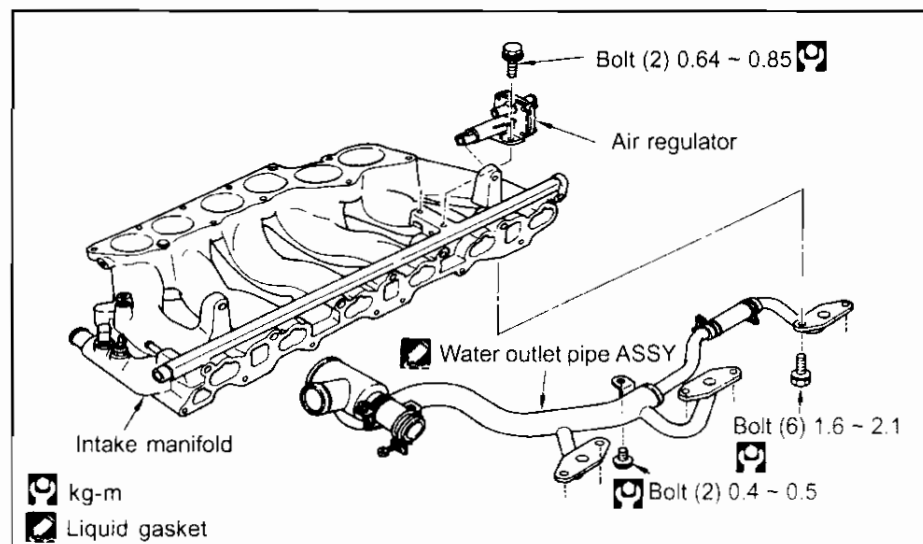
**10-4 INTAKE MANIFOLD****Removal**

- Remove collector ASSY. For detailed removal process refer to "Collector" section.
- Remove fuel injector ASSY.
- Remove water hose.
- Remove oil level gauge guide bolt.

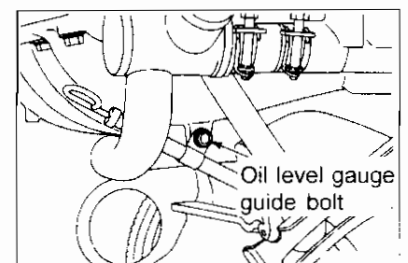

- Remove rear water pipe connector bolt.

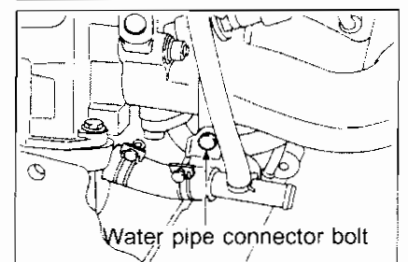

RB25DE ENGINE

- Remove intake manifold ASSY bolts and nuts (1, 10, 13) in the orders shown in the figure on right.
- Remove the intake manifold gasket.
- Remove water pipe ASSY.

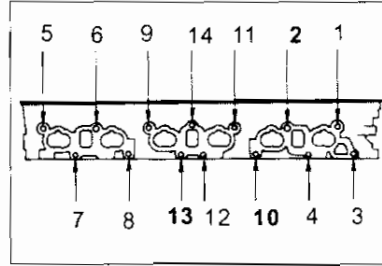

**Installation**

- Remove old liquid gasket on the water pipe, in the groove and on the intake manifold. Clean all contact surfaces with white gasoline or equivalent.
- Apply a continuous bead of liquid gasket (KP510 00150) 2.0 ~ 3.0 mm wide to sealing surface using the tube pressor.

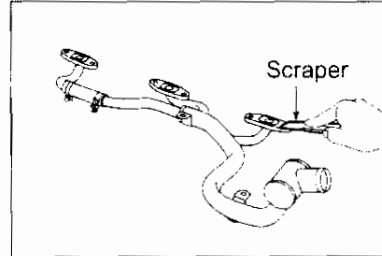

**Caution**

Installation should be performed within 5 minutes after coating the liquid gasket.  
Wait at least 30 minutes before refilling engine coolant.

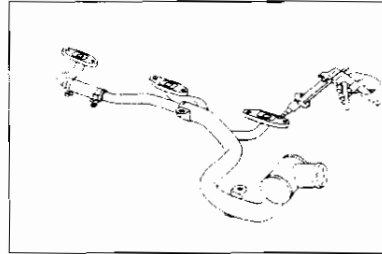

- Install the water pipe ASSY  
**Tightening torque (kg-m):** (A) 0.4 ~ 0.5  
(B) 1.6 ~ 2.1

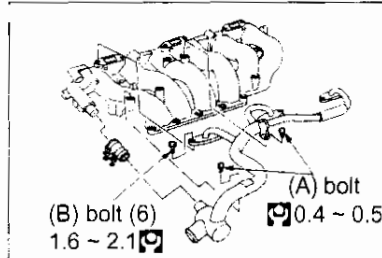

- Install intake manifold gasket.
- Install the bolts and nuts (2, 10, 13) uniformly in several stages in the order shown in the figure on the right.  
**Tightening torque (kg-m):** 1.8 ~ 2.2

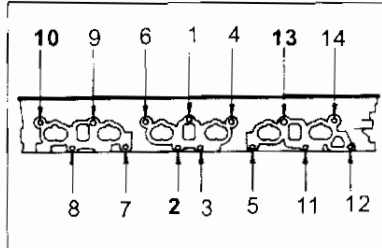

- Install the front oil level gauge guide bolt.

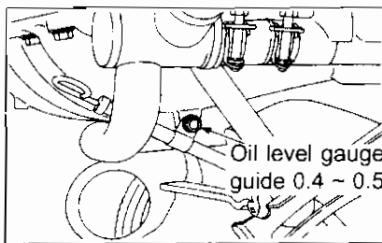

- Install the rear water pipe connector bolt.  
**Tightening torque (kg-m):** 0.4 ~ 0.5
- Install the water hose.

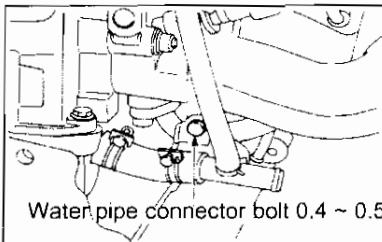



10-5 EXHAUST MANIFOLD

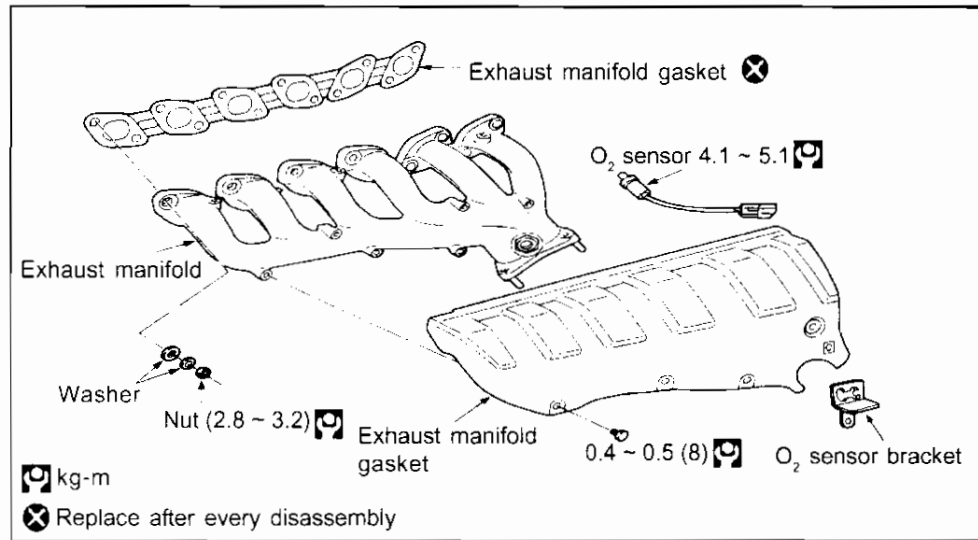

**Removal**

- Remove the following:
  - Under cover
  - Exhaust front tube
  - O<sub>2</sub> sensor connector
  - Exhaust manifold cover
- Remove the exhaust manifold nuts in the order shown in the figure on right.
- Remove the exhaust manifold gasket.

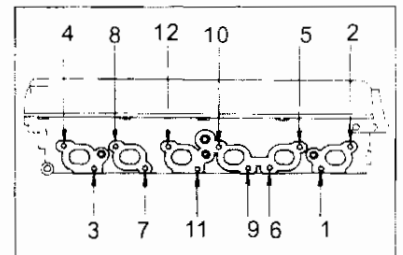

**Inspection**

- Look for any distortion on exhaust manifold.

**Gas leak inspection**

- After removing exhaust manifold, make sure there are no traces of gas leaks from any part of installation.

**Installation**

- Install exhaust manifold gasket.
- Install exhaust manifold, washer and the yoke.
- Make sure not to make mistake between No. 3 and No. 4 yoke as configurations are different.

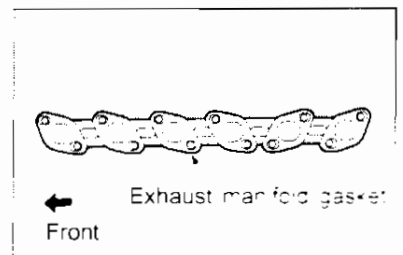

Item	D (mm)
No.3 & No.4 port	22
Other than those above	24

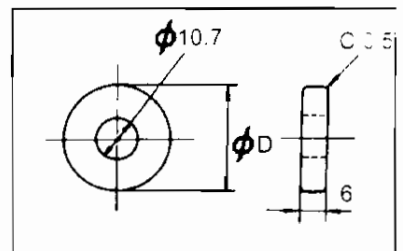

- Make sure the washer is facing the correct way when installing.

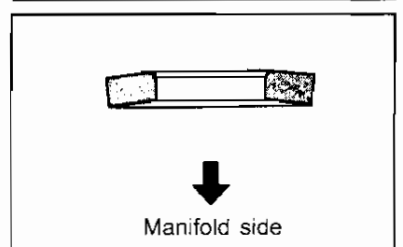

RB25DE ENGINE

- Tighten exhaust manifold nuts in the order shown in the figure on right.
- Install exhaust manifold cover.
- After installation, crank engine and check for gas leak.

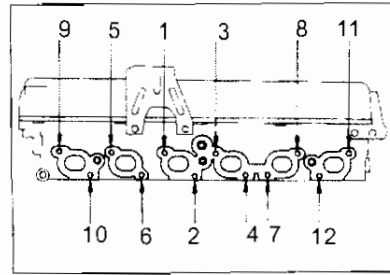

10-6 TIMING BELT

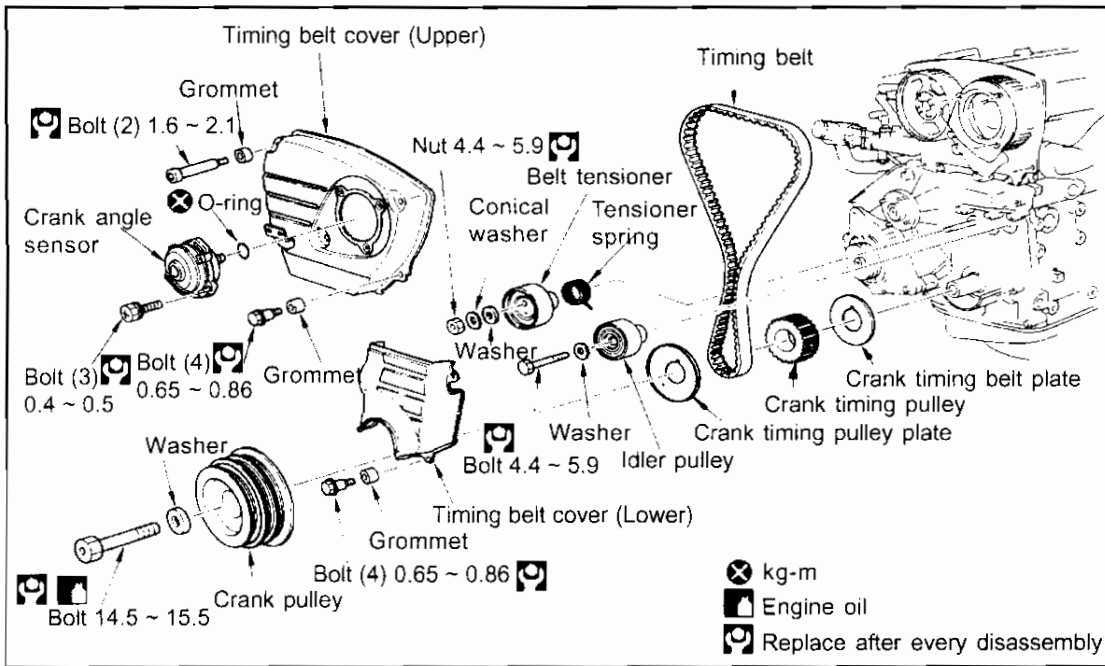

Removal

- Remove under cover.
- Drain cooling water from the radiator engine drain plug.
- Remove supplementary belts.
- Remove the radiator, the fan shroud and the cooling fan.
- Check No. 1 cylinder compression T.D.C position.
- Align the crank pulley timing mark and belt cover timing mark indicator (0° position). At this time the No. 1 cylinder is in the compression T.D.C position when the camshaft is located as described as follow:
- No. 1 cylinder is at the compression stroke top dead center when both the No. 1 intake and exhaust side cams do not move the valve lifters.

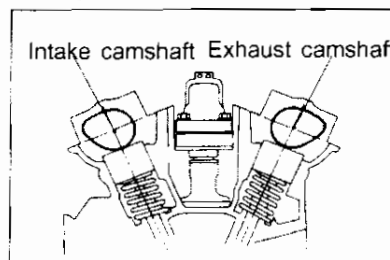
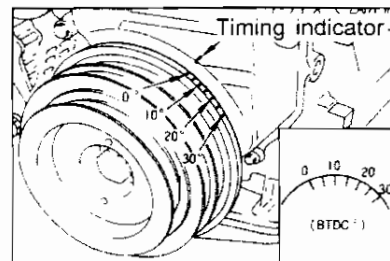

## RB25DE ENGINE

- Remove the oil filter cam from intake side rocker cover and check that the front end of camshaft faces the intake side.

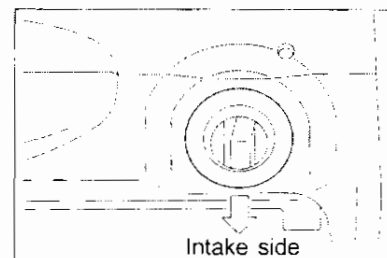

- Remove crank angle sensor.
- Remove starter motor then install ring gear stopper.
- Remove crank pulley bolts.

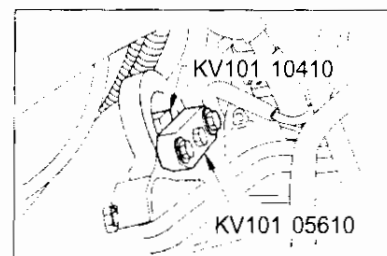

- Use pulley puller to remove the crank pulley (bolt size: M6 x 1.0 length below head approx. 50 mm)

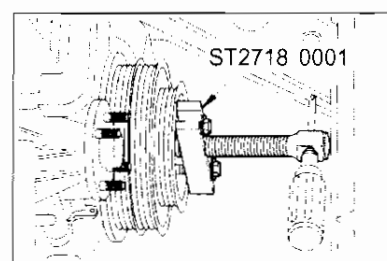

- Remove crank angle sensor bracket, then remove timing belt cover. Timing belt cover is separated into upper and lower sections, first remove the upper section then remove lower section.

**Caution:**

Do not scratch dried liquid packing when removing and installing the timing belt cover.

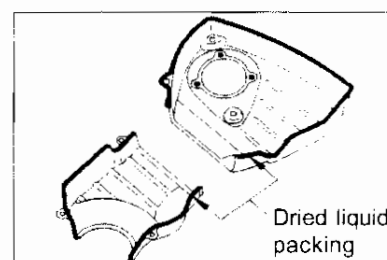

- Remove belt tensioner.
- Secure the tensioner firmly with a hexagonal wrench when removing and installing bolt tensioner nuts.

**Caution:**

Do not loosen inserted stud at disassembly.

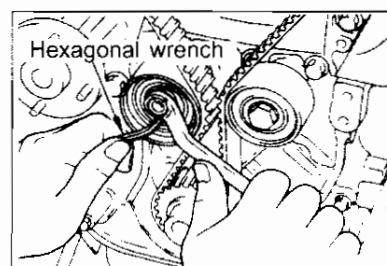

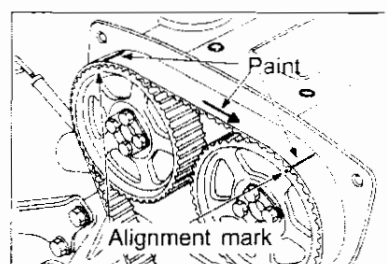

- If paint on timing belt is unclear when disassembly is performed, paint a mark on the belt that indicates rotation direction.
- Remove the timing belt.

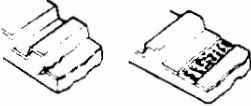

**Timing belt inspection**

- Replace timing belt if any problems are indicated at the inspection.  
It is recommended to replace timing belt every 100,000 km.

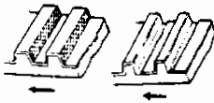
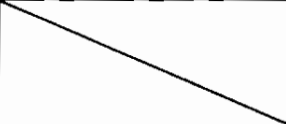
Item	Condition	Cause
Tooth missing Cracked tooth		Camshaft lock Crank sensor lock
Cracks on rear side		Tensioner lock Engine overheat Interference with belt cover etc.
Wear and cracks on the side		Belt misalignment Belt plate malfunction
Worn teeth		Sliding motion resistance in crank sensor and the camshaft
Oil or water adhesion		Oil seal malfunction Water leaks in water pump

**Caution:**

Do not twist or bend the timing belt. Make sure there is no oil film or water on the belt. Make sure there is no wear or cracks can be found on idler pulley, tensioner pulley, cam pulley crank timing pulley and the tensioner spring. Also check if they rotates smoothly.

**Installation**

- Assemble the tensioner spring so it engages the belt tensioner pulley as shown in the figure.
- The tensioner spring must be assembled together with the belt tensioner pulley in the cylinder block.
- When the tensioner pulley is free, hook the tensioner spring on the upper side of the tensioner spring stud.

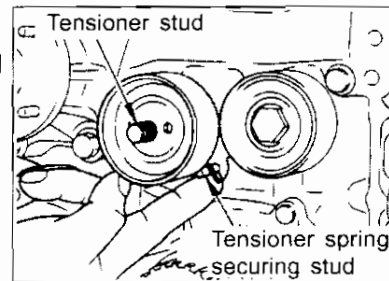
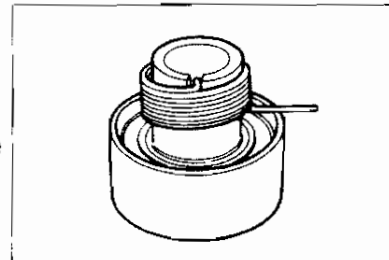

**Tensioner spring specifications**

Spring wire diameter	Set angle (a)	Free angle (-)	Classification paint
1.8 mm	Approx. 20°	Approx. 163°	Yellow-green

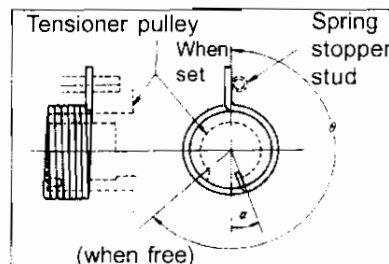

- Care must be taken to install the conical washer in correct direction.
- Install the crank timing pulley and the plate.

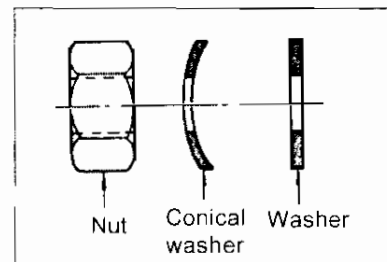

- Be careful to observe front and rear positioning of timing belt plate, crank timing pulley and crank timing pulley plate when installation is performed.

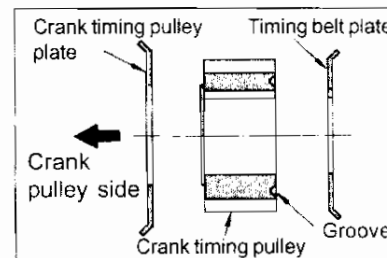

- Align the alignment marks of the exhaust and intake cam pulleys with the respective belt cover alignment marks (No. 1 cylinder is at T.D.C).
- Align the crank timing pulley alignment mark with the mark on oil pump housing. The groove must be straight up (No. 1 cylinder compression T.D.C).
- Move the belt tensioner clockwise at 70 ~ 80° angle, and secure it temporarily with belt tensioner nut. (This will minimize the offset between the tensioner shaft and the timing belt).
- Align the timing belt pulley marks and install belt. Align the number of ridges of exhaust cam pulley alignment mark and crank pulley (inner) alignment mark as shown in the figure on right.
- After loosening the nuts and adjusting the belt tension, secure tensioner with hexagonal wrench so it does not rotate together and tighten the nuts.

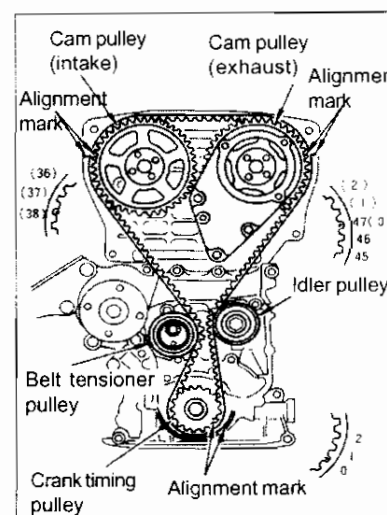

**Caution:**

At timing belt assembly, check that it engages correctly with pulley and it does not float.

**Timing belt tension adjustment**

- Remove the spark plug and align timing belt alignment marks with pulley marks and install timing belt on to each pulley.
- Loosen the tensioner nut so belt tension is applied by tensioner spring.
- Turn crank pulley clockwise more than two turns to check belt movement and stop slowly at No. 1 cylinder compression T.D.C.
- Insert hexagonal wrench in hexagonal hole. Hold the tensioner with your hand and tighten the tensioner securing nut to specified tightening torque.

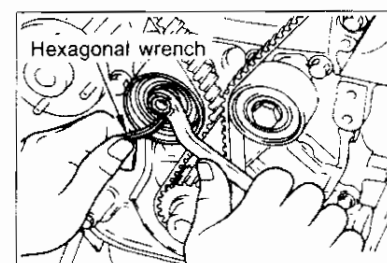

**Tightening torque (kg-m): 4.4 ~ 5.9**

- At this condition belt tension should be approximately 20 kg.

RB25DE ENGINE

- Install crank angle sensor bracket.

**Tightening torque (kg-m):** 2.1 ~ 2.7

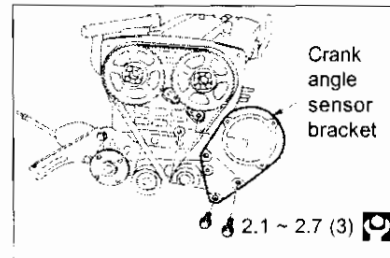

- Install timing belt cover in order of lower then upper.

**Tightening torque (kg-m):** (A) 1.6 ~ 2.1  
(B) 0.65 ~ 0.86

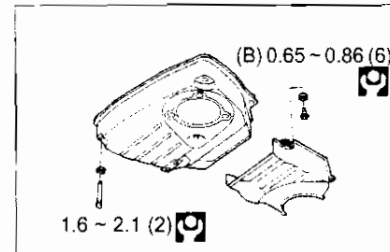

**Install crank angle sensor**

- (1) Apply chassis grease to drive unit spline.
- (2) There is a flange inside the drive unit spline so spline only has one insertion position. Check the alignment *before assembly*.
- (3) Check that the crank angle sensor can be inserted easily in belt cover holes and sensor moves lightly to right and left, then tighten bolts.
- (4) If the sensor doesn't move lightly, loosen the belt cover bolts with crank angle sensor inserted. Move belt cover to align belt cover hole center and camshaft center. Tighten bolts making sure the crank angle sensor moves lightly.

**Tightening torque (kg-m):** 0.4 ~ 0.5

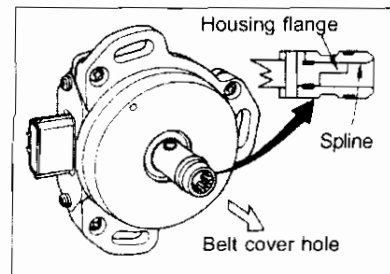

- Position the washer for the crank pulley bolts so the flat surface contacts the crank pulley side and then assemble.
- Apply engine oil to the threads of crank pulley bolts.

**Tightening torque (kg-m):** 14.5 ~ 15.5

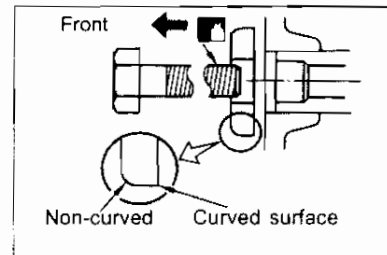

10-7 OIL PAN

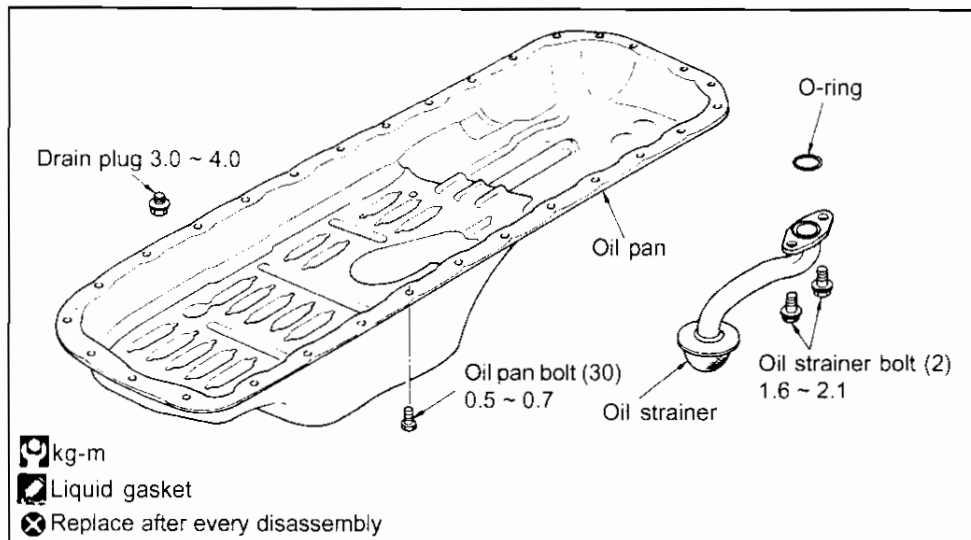

**Removal**

- Drain engine oil.
- Remove radiator fan.
- Remove front stabilizer.
- Remove engine right & left gusset.
- Remove oil pan bolts in order of sequence shown in the figure on right.
- Insert seal cutter between cylinder block and oil pan.
- Remove oil pan by tapping the seal cutter with hammer.
- If removing the oil pan from the vehicle, first remove front engine mounting nut.
- Use the hoist crane to lift up the oil pan forward.
- From the gap between the cylinder block and the oil pan, use a tool such as spanner to remove oil strainer bolt belt.
- Pull the oil pan out.

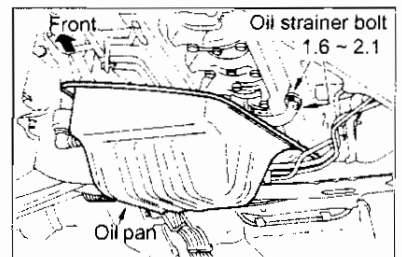
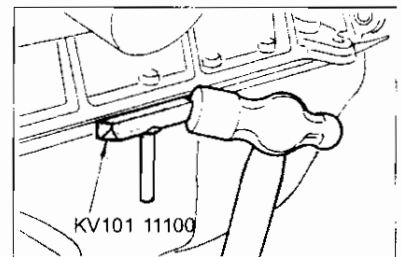
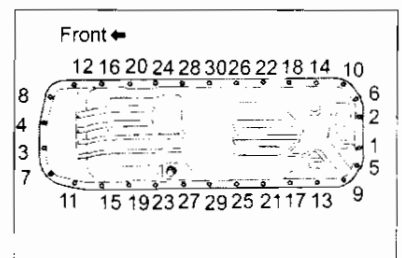

**Caution:**

Care must be taken not to strain the hoses and the harness too tightly when lifting up the engine using the hoist crane.

## RB25DE ENGINE

**Installation**

- Use a scraper to remove all traces of oil liquid gasket from cylinder block and oil pan surface.

**Caution:**

Remove all gasket material and other foreign material that falls into the oil pan.

- Clean all contact surfaces with white gasoline or equivalent.
- Cut off nozzle tip of liquid gasket (KP510 00150) at point shown in the figure on right and insert into tube presser.

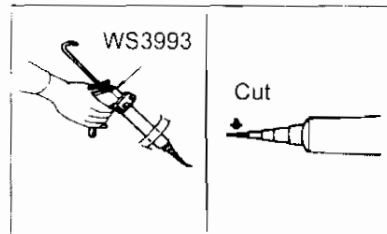
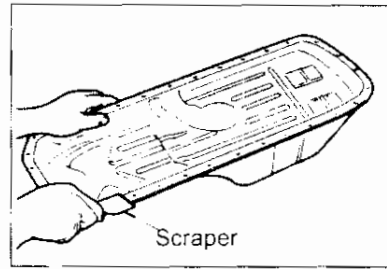

- Apply a continuous bead of liquid gasket (KP510 00150) to inner sealing surfaces 4 mm wide.
- Installation should be performed within 5 minutes.

**Caution:**

Be sure liquid gasket application is 4.0 mm wide.

Wait at least 30 minutes before refilling engine oil and engine coolant.

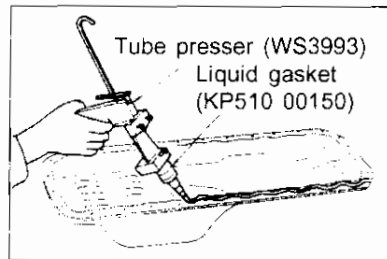
**10-8 OIL SEAL****Valve oil seal**

- Remove the following parts:
  - Engine undercover
  - Cleaning fan
  - Timing belt cover, timing belt
  - Cam pulley
  - Back plate
  - Rocker cover
  - Ornament
  - Camshaft
  - Hydraulic valve lifter
  - Valve spring
- Use oil seal puller to remove valve oil seal.
- To prevent valve omission have the piston in compression T.D.C position.

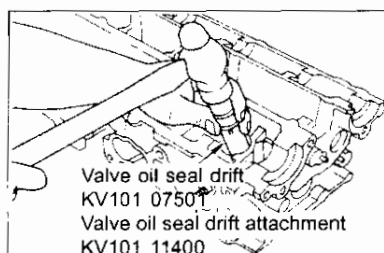
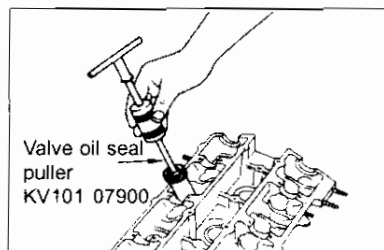



## RB25DE ENGINE

- Valve oil seal installation measurement is as shown in the figure on right.

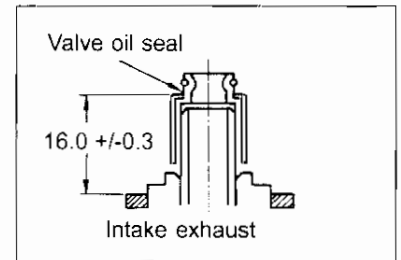
**Camshaft oil seal**

- Remove the following parts:
  - Engine undercover
  - Cooling fan
  - Crank pulley
  - Timing belt
  - Crank angle sensor bracket
  - Cam pulley
  - Back plate
- Remove No. 1 camshaft then remove camshaft oil seal.
- Apply engine oil to area around the oil seal lip.
- Care must be taken not to scratch or damage oil seal retainer. Use oil seal drift smaller than oil seal (41 mm) and insert it at same level as front surface of oil seal retainer.

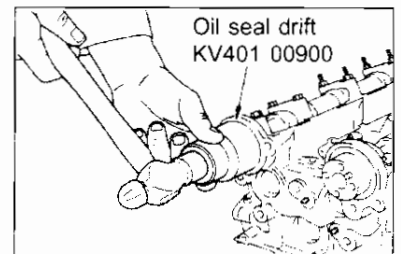
**Front oil seal**

- Remove the following parts:
  - Engine undercover
  - Cooling fan
  - Crank pulley
  - Timing belt
  - Oil pan
  - Oil pump
- Use a screwdriver to remove front oil seal from front cover.
- Use oil seal drift and insert new front oil seal at same level as front surface.
- Face the oil seal mark outside (front side) when inserting.

**Caution:**

Do not touch the oil seal lip by finger as grease is applied to area around the oil seal lip.

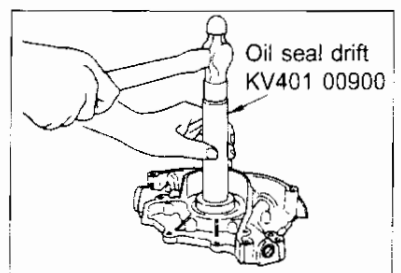
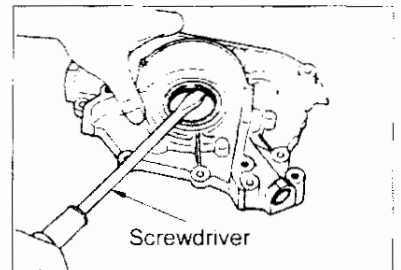
**Rear oil seal**

Remove the following parts:

- Transmission (or A / T)
- Flywheel (or drive plate)
- Rear plate
- Rear oil seal retainer

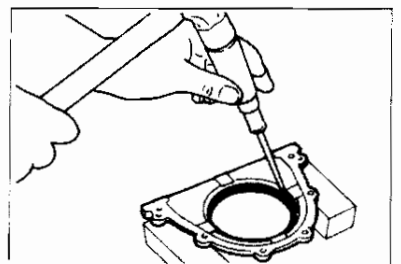

RB25DE ENGINE

- Apply engine oil or chassis grease to area around oil seal lip.
- Care must be taken not to scratch or damage oil seal retainer. Use oil seal drift (External diameter: (100 mm) and insert it at same level as front surface of oil seal retainer.

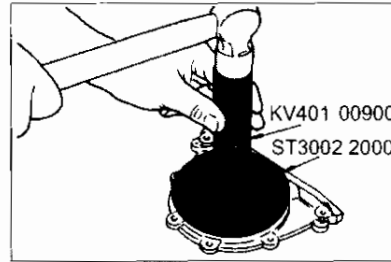

**Cleaning**

- Use scraper to remove liquid gasket.

Caution:

Make sure to remove liquid gasket in the groove.

- Clean the cylinder block side using same method and clean the surface with white gasoline.

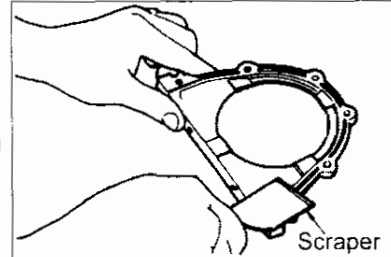

**Rear oil seal installation**

- Installation should be performed within 5 minutes.
- Cut off nozzle tip of liquid gasket (KP510 00150) at point shown in the figure on right and insert into tube presser.

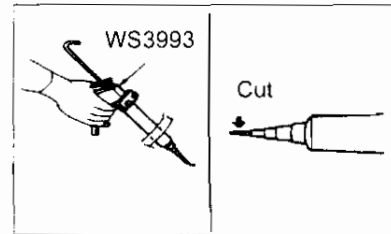

- Apply a continuous bead of liquid gasket (KP510 00150) to rear oil seal retainer surfaces 2 ~ 3 mm wide.

Caution:

Wait at least 30 minutes before refilling engine oil and engine start.

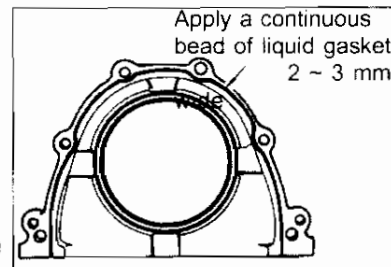

- Install rear oil seal retainer by aligning to dowel pin.
- Tighten 6 bolts uniformly.

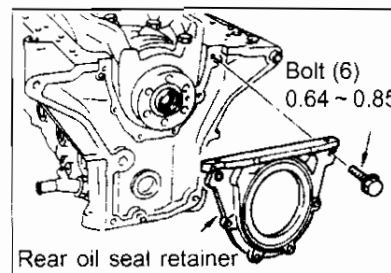

**10-9 ROCKER COVER / IGNITION COIL**

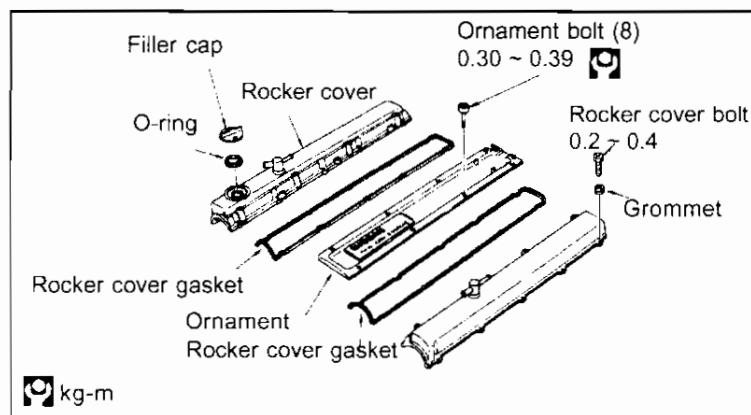
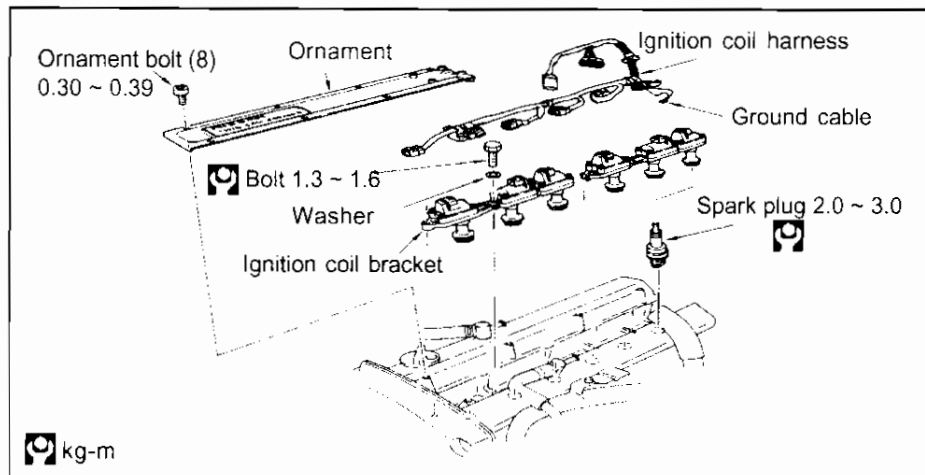

**Removal**

- Remove Rocker cover ornament.
- Remove ignition coil harness and remove ignition coil.

- Loosen and remove the rocker bolts (intake and exhaust) in the order shown in the figure on right.
- Remove the rocker cover.

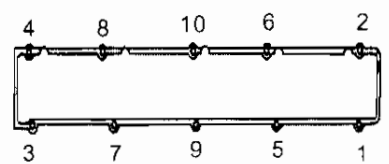

**Installation**

- Install the rocker cover.
- Tighten the rocker cover screw uniformly in the order shown in the figure on right in several stages.

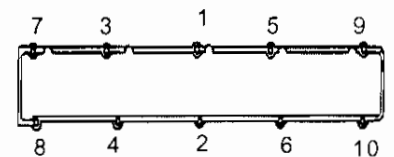

- Install the ignition coil bracket.
- Install the ornament.

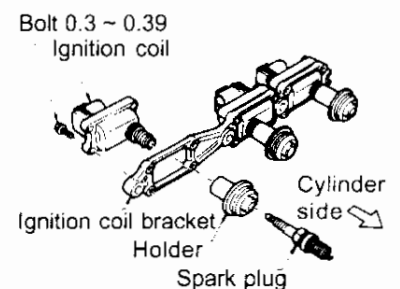

10-10 CYLINDER HEAD

(1) Cylinder head removal & installation

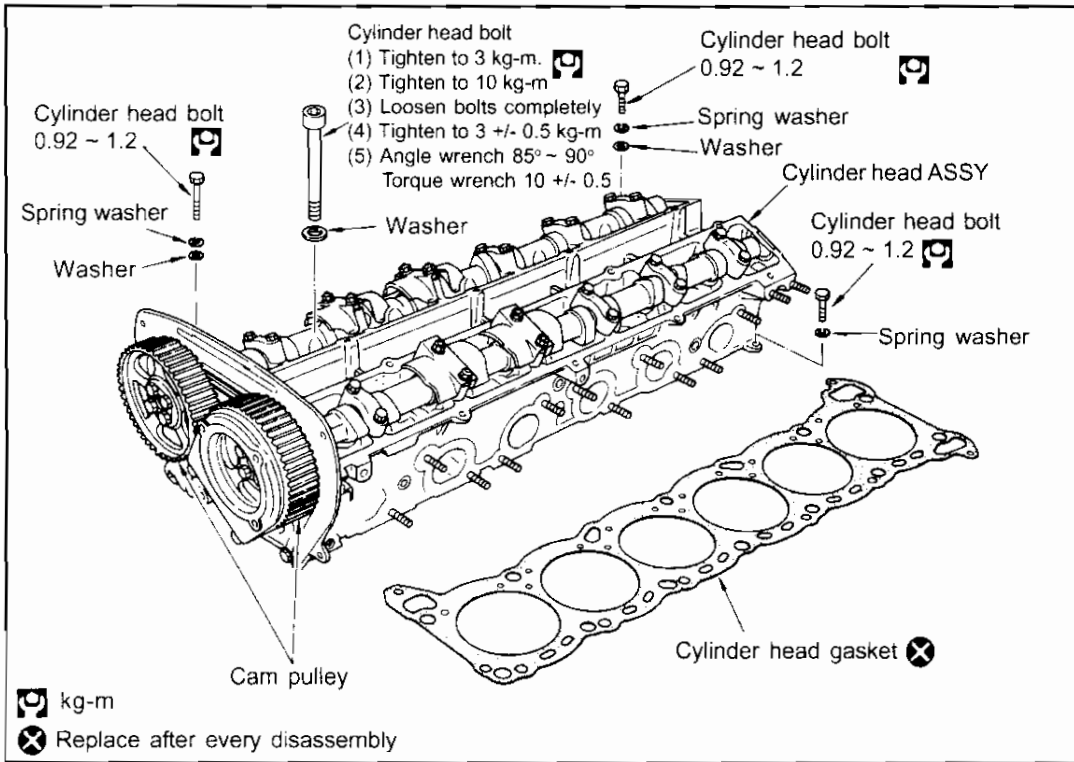

Removal

- Remove cooling water completely from the radiator, cylinder block drain plug.
- Remove the following:
  - Connector and intake manifold
  - Exhaust manifold
  - Timing belt
  - Rocker cover, ignition coil
  - Spark plug
- Remove the cylinder head bolts in the sequence shown in the figures on right.
- Remove the cylinder head, then cylinder head gasket.
- Check for any distortion on the cylinder head.
- Check for any distortion on the cylinder block surface.

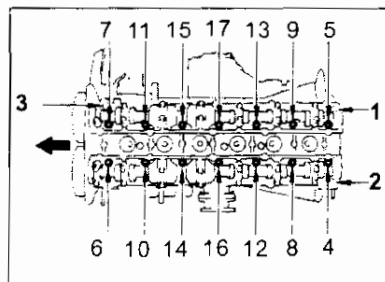
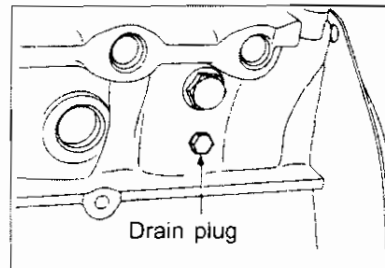

4 ~ 17 M1x1.5    1 ~ 3 M6x1.0

**Installation**

- Before installing the cylinder head ASSY to cylinder block, the crank pulley and the cam pulley must be positioned at No. 1 cylinder compression T.D.C position.
- Align the crank pulley timing mark and the timing belt cover timing indicator (0° position).

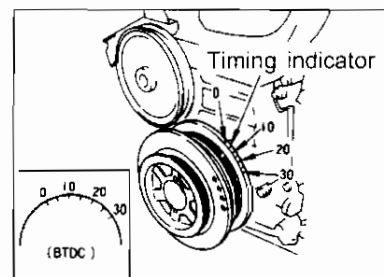

- Align intake and the exhaust cam pulley alignment mark to respective belt cover alignment marks.

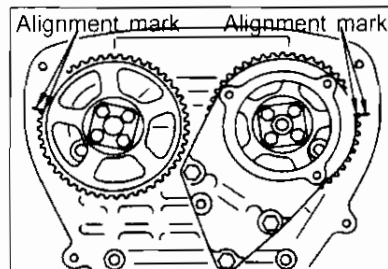

- Make sure it is positioned at No. 1 compression T.D.C position.

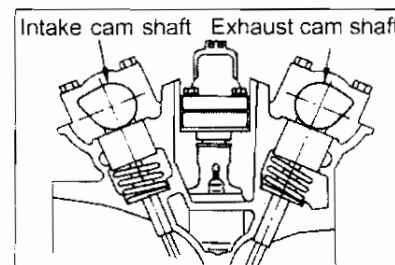

- Install cylinder head gasket.
- Install the bolts in sequence shown in the figure on right.
- The cylinder head bolts are torqued by two-step method. Tighten the bolts in two steps.

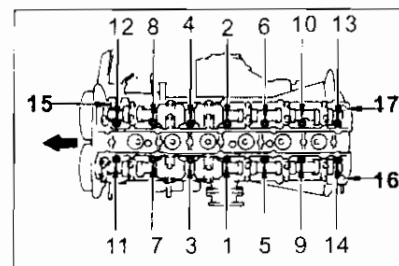

- (1) Tighten to 3 kg-m.
  - (2) Tightened to 10 kg-m.
  - (3) Loosen bolts completely 0 kg-m.
  - (4) Tighten to 3 ~ 3.5 kg-m.
  - (5) Turn bolts 80 ~ 90° clockwise when angle wrench is used.
- Tighten bolts to 10 +/-5 kg-m when torque wrench is used.

**Caution:**

When angle wrench is not used, never attempt to approximate the tightening angle visually.

- Install ignition coil and the spark plug.
- Install the timing belt.
- Install the exhaust manifold.
- Install collector and intake manifold.
- Check the air flow of the hydraulic bulb lifter.
- Push the hydraulic bulb lifter crest surface with finger and check the slump.

**Slump limit value (mm): 1.0**

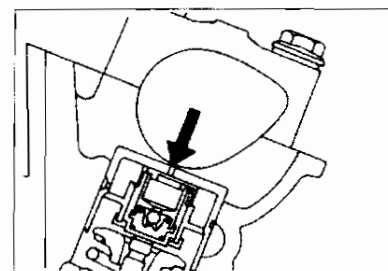

RB25DE ENGINE

- There is a possibility of entrained air within the hydraulic valve lifter if the slump is over 1.0 mm. Air need to be released from hydraulic valve lifter.
- Idle the engine for approximately 10 minutes at 4000 rpm after installing the rocker cover.
- Remove the rocker cover and push the hydraulic valve lifter surface to check the slump of cam base circle.
- Replace the hydraulic valve lifter if the value is over the limit.

(2) Cylinder head disassembly, assembly & inspection

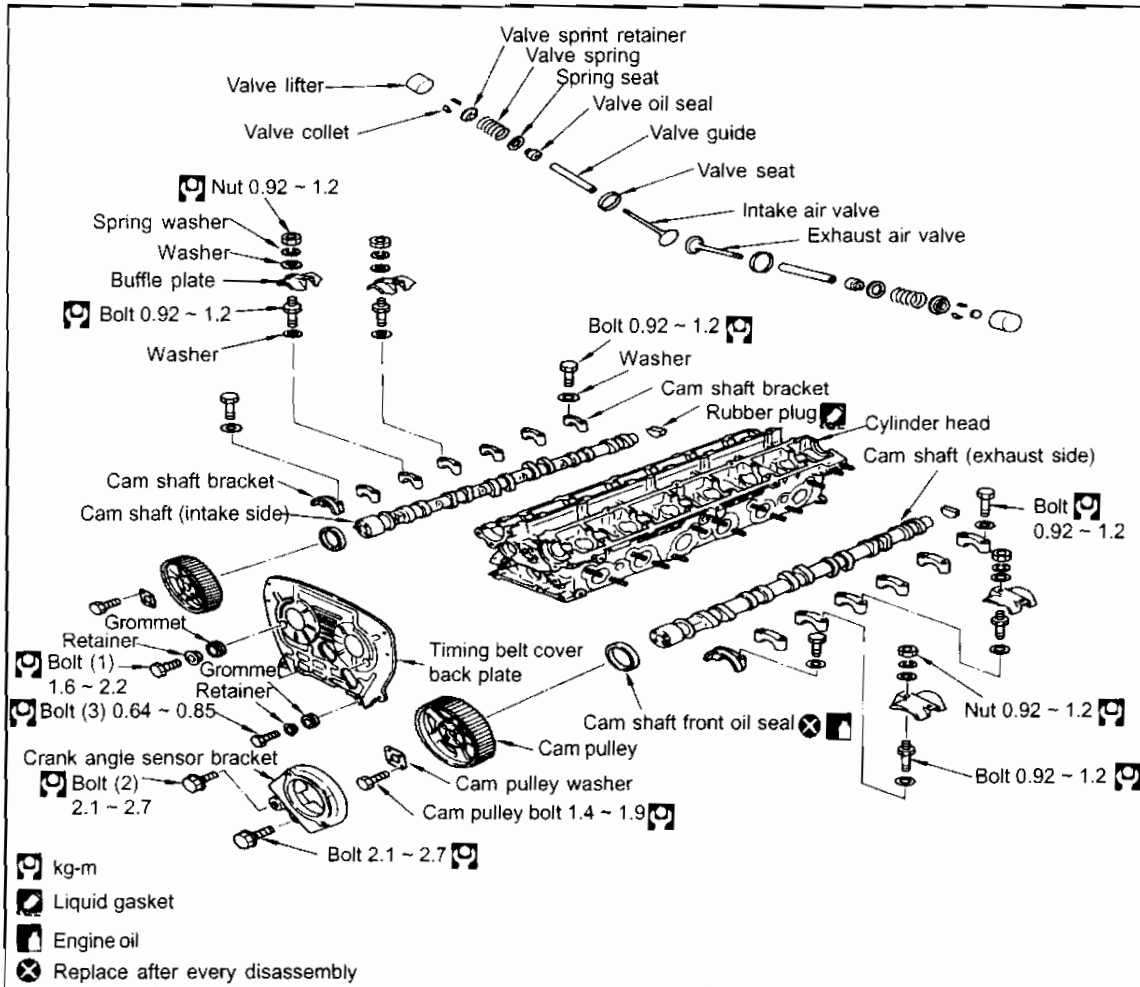

**Disassembly**

- Use the proper tool to secure the hexagonal part in front of camshaft to remove cam pulley.
- Remove timing belt cover back plate.
- Position the cam shaft knock-pin to the position shown in the figure on right.

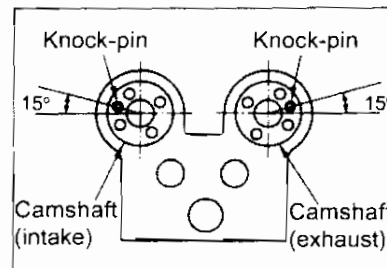

- Remove cam bracket bolts by loosening them gradually in several stages, in reverse sequence shown in the figure on right.

**Caution:**

Before removing camshaft bracket, paint marks to indicate bracket position and direction.

- Remove the cam bracket.

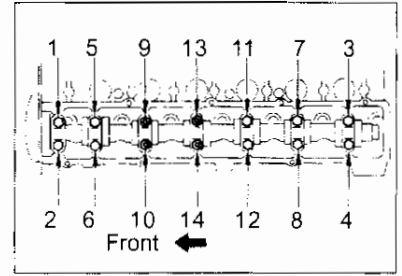

- Intake and exhaust camshaft can be identified by identification paint color and presence of a spline gear for driving the crank angle sensor.

Camshaft	Identification paint	Spline gear
Intake camshaft	Purple	No
Exhaust camshaft	Orange	Yes

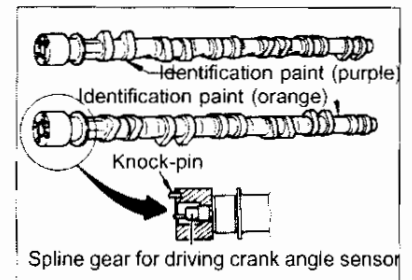

Remove hydraulic valve lifter.

- Hydraulic valve lifter is nonseparable.
- Do not store hydraulic valve lifter up side down or on its side.
- Store hydraulic valve lifter in the engine oil when storing temporarily.

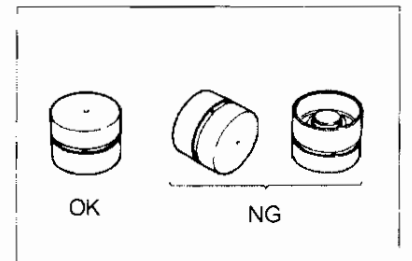

- Use valve spring compressor (KV101 08950) to remove valve springs.

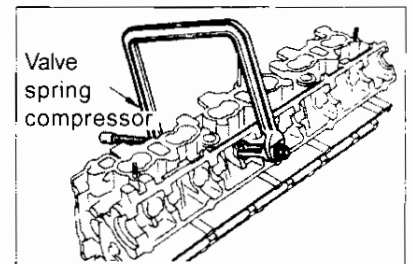

**Cylinder head inspection**

- Use scraper to remove any traces of oil, water scale, gasket, sealing agent, carbon etc. from cylinder head surfaces.
- Measure lower surface of cylinder head in six directions to check for distortion.

**Limit (mm): 0.2**

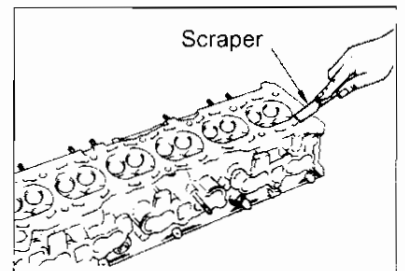

- When distortion is just over the limit, resurface the cylinder head.
- If distortion exceeds the limit, replace cylinder head.

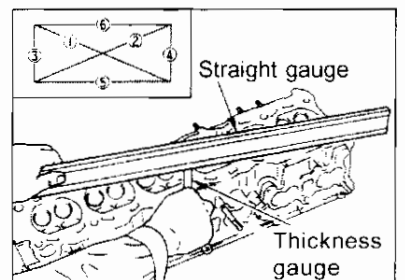

**Camshaft visual inspection**

- Visually inspect camshaft for any wear or damage.

## RB25DE ENGINE

**Camshaft run-out**

- Use V-block on fixed surface and support both camshaft end journals (No. 1 & No. 7).
- Avoid the oil groove in the center of the No. 4 journal and position the dial gauge vertically.
- Rotate the cam shaft by hand to one direction and read the movement width on dial gauge.
- The run-out is equal to half of the movement width indicated on dial gauge.

**Standard value (mm): 0.05**

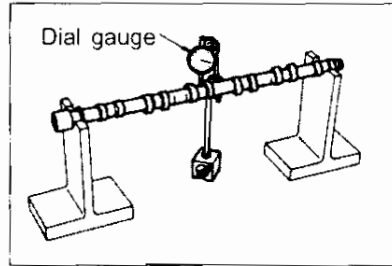
**Cam nose diameter inspection**

Use micrometer to measure diameter of cam nose.

**Intake standard value (mm): 39.705 ~ 39.895**

**Exhaust standard value (mm): 39.205 ~ 39.395**

Replace camshaft if diameter value differs.

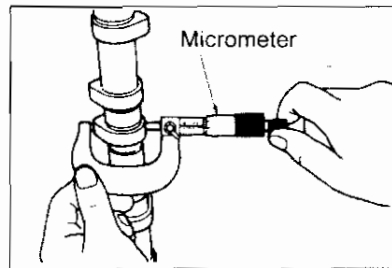
**Camshaft oil clearance**

- Tighten the cam bracket to specified torque.  
Use inside micrometer to measure inside diameter.

**Standard value (mm): 28.000 ~ 28.021**

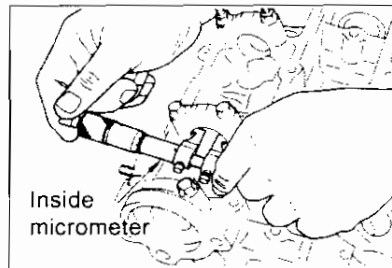

- Use micrometer to measure outside diameter of camshaft journal.

**Standard value (mm): 27.935 ~ 27.955**

- Inspect that the camshaft oil clearance measurement is within specified value.

**Oil clearance = cam bracket inside diameter - camshaft journal (outside diameter)**

**Standard value (mm): 0.045 ~ 0.086**

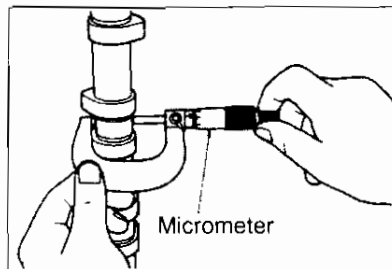
**Camshaft end play**

- Assemble camshaft and tighten cam bracket to standard value.
- Set a dial gauge at front end of the camshaft in thrust direction. When camshaft moves in front and rear direction, read the dial gauge run-out width.

**Standard value (mm): 0.030 ~ 0.080**

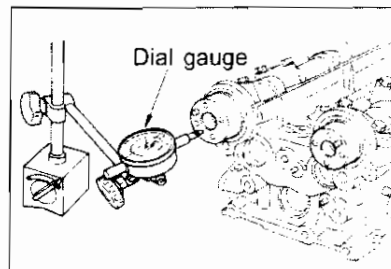



**Valve guide clearance inspection**

- Protrude valve approximately 15 mm from valve guide home into combustion chamber. Measure valve deflection by swinging into direction parallel to dial gauge.
- The clearance is equal to half of the dial gauge reading (deflection width).

<b>Valve guide clearance (mm)</b>	<b>Intake:</b>	<b>0.1</b>
	<b>Exhaust:</b>	<b>0.1</b>

- Replace valve or valve guide if clearance exceeds limit.

**Valve guide replacement**

- Use valve guide remover and tap it from combustion chamber side to remove seal.

- Rectify cylinder head valve guide hole using valve guide reamer.

<b>Rectified valve standard value (mm)</b>	
<b>Intake &amp; exhaust:</b>	<b>6.000 ~ 6.018</b>

- Heat cylinder head in an oil bath to approximately 150 ~ 160°C. Use a valve guide drift and press valve guide from camshaft side.

- The press-fit dimensions are shown in figure on right.

- Ream the inside of the inserted valve guide with valve guide reamer.

<b>Finished internal diameter standard value (mm)</b>	
<b>Intake &amp; exhaust:</b>	<b>10.175 ~ 10.196</b>

**Valve seat inspection**

- Check contact surfaces of the valve seat and the valve.
- Replace valve or valve seat if contacting surface is too large or improper.

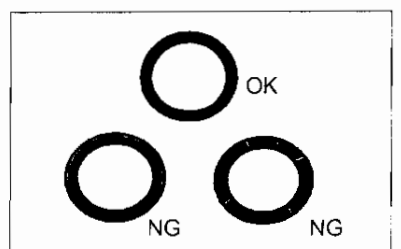
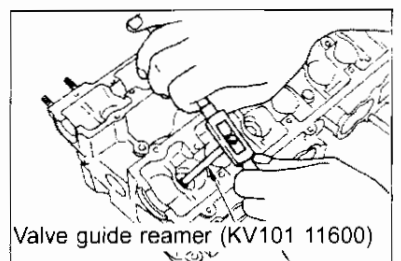
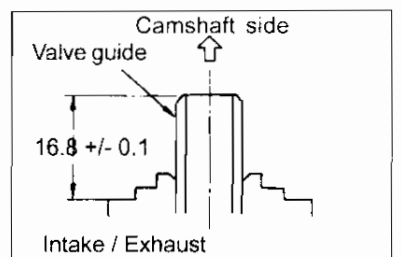
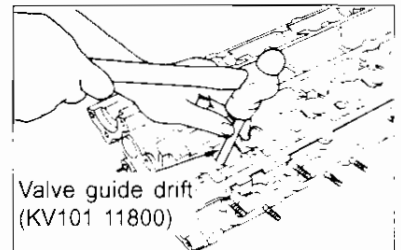
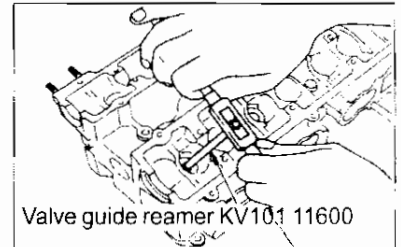
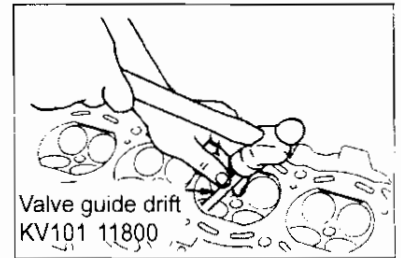
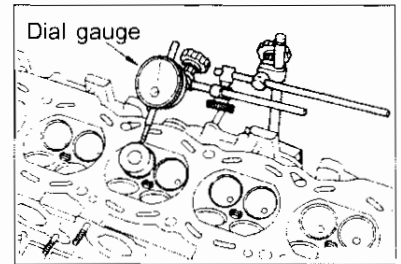

**Valve seat replacement**

- Cut and grind valve seat to remove the valve seat.
- Readjust the mounting hole for over size valve seat.

**Standard value (mm):**

Intake	<b>36.5 +0.016 -0</b>
Exhaust	<b>32.0 +0.016 -0</b>

- Readjust the valve guide centre and concentric circle.
- Heat up the cylinder head in an oil bath to approximately 110 ~ 130°C.
- Use valve seat drift to tap it until it strike the bottom.

- When not using valve seat drift:
- Use dry ice to cool valve seat for approximately 5 minutes.
- Heat up the cylinder head to approximately 80 °C.
- Insert cooled valve seat into cylinder head quickly.

Caution:

Do not directly touch cooled valve seat with hands.

- Readjust the valve seat using valve seat cutter or valve seat grinder.

- Valve seat shape and measurement is as shown in the figures on right.

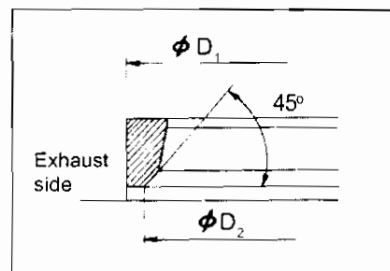
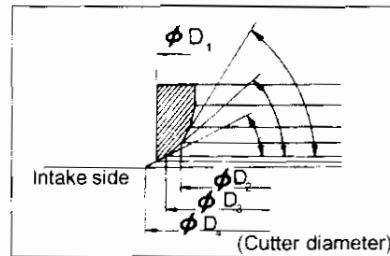
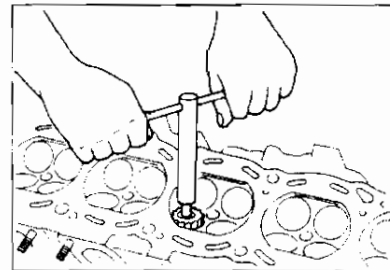
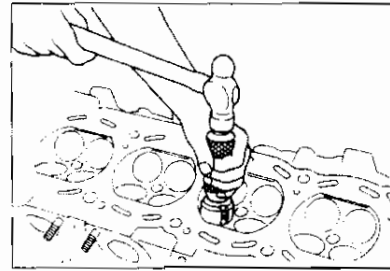
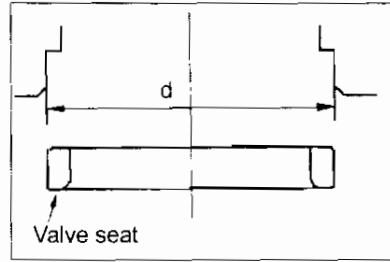

Item		Cylinder head readjustment dimension	Valve seat measurement			
Valve over size		$\phi d$	$\phi D_1$	$\phi D_2$	$\phi D_3$	$\phi D_4$
Intake	Standard	36.0 <sup>+0.016</sup> <sub>-0</sub>	36.0 <sup>+0.113</sup> <sub>-0.097</sub>	32.0	33.8 <sup>+0</sup> <sub>-0.2</sub>	37.0
	0.5	36.5 <sup>+0.016</sup> <sub>-0</sub>	36.5 <sup>+0.113</sup> <sub>-0.097</sub>	32.0	33.8 <sup>+0</sup> <sub>-0.2</sub>	37.0
Exhaust	Standard	31.5 <sup>+0.016</sup> <sub>-0</sub>	31.5 <sup>+0.096</sup> <sub>-0.080</sub>	29.1 <sup>+0</sup> <sub>-0.2</sub>	-	-
	0.5	32.0 <sup>+0.016</sup> <sub>-0</sub>	32.0 <sup>+0.096</sup> <sub>-0.080</sub>	29.1 <sup>+0</sup> <sub>-0.2</sub>	-	-

**Valve inspection****Outside diameter measurement**

- Use micrometer to measure each dimension.

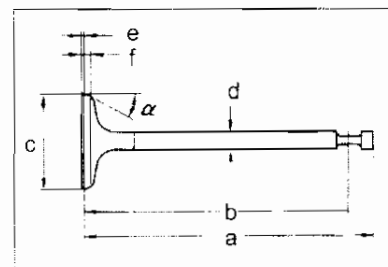

(mm)

Valve	a	b	c	d	e	f	$\alpha$
Intake	85.3 ~ 85.5	80.78 ~ 81.08	34.00 ~ 34.02	5.965 ~ 5.980	1.15 ~ 1.45	2.60 ~ 2.90	30°
Exhaust	87.3 ~ 87.5	82.78 ~ 83.08	29.00 ~ 29.07	5.960 ~ 5.945	1.35 ~ 1.65	3.2 ~ 3.4	15°

**Valve spring squareness inspection**

- Place a right-angle straight edge (L-square) so it contacts the spring. Turn the spring and measure the maximum clearance between upper spring surface and the right angle surface to determine out-of-square distance.

**Limit (mm):** 1.8

- Replace the valve spring if the out-of-square distance is over the limit.

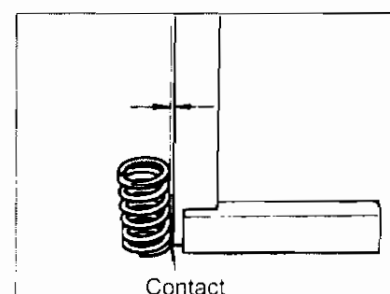
**Free length and pressure load inspection**

- Use a valve spring tester to check the spring pressure.

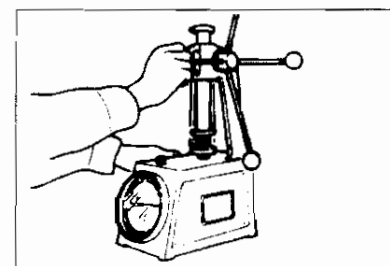
**Free length (mm):** 43.1**Installation load (kg):** 24.0**Hydraulic valve lifter visual inspection**

- Visually inspect camshaft rotational area on lifter side and lifter bore rotational area for any wear or damage.
- Replace if there are any abnormality.

**Caution:**

Do not disassemble hydraulic valve lifter. It is nonseparable unit.

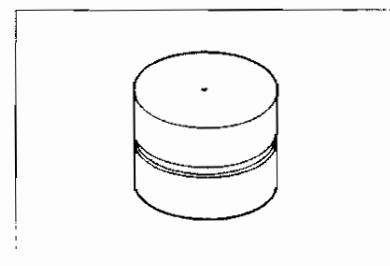
**Hydraulic valve lifter outside diameter**

- Use a micrometer to check the valve lifter outside diameter.

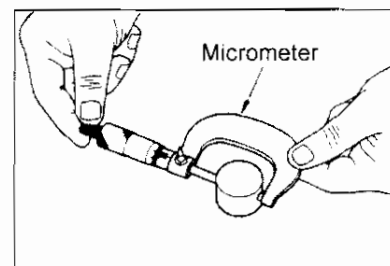
**Standard value (mm):** 30.955 ~ 30.965

**Hydraulic valve lifter hole internal diameter**  
**Standard value (mm): 31.000 ~ 31.020**

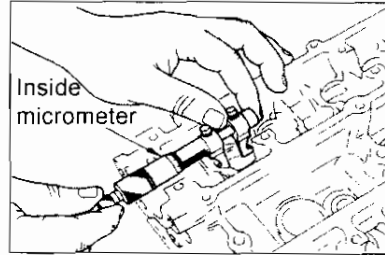

**Hydraulic valve adjuster clearance**

Hydraulic valve clearance =  
 Hydraulic valve clearance hole internal diameter - hydraulic valve exterior diameter

**Installation**

- Install valve associated parts.
- For detailed information on how to install new valve oil seal refer to section on "Oil seal replacement".
- Install valve spring with narrow pitch end towards cylinder head (identification color side down).
- Install spring retainer.

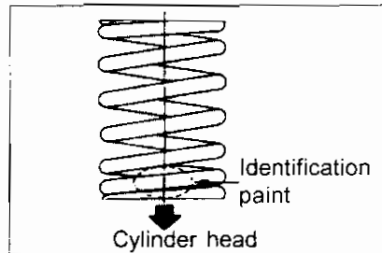

- Use valve spring compressor to install valve collet.
- Apply a small coating of petroleum jelly to the internal surface of collet.
- Use a magnetic screwdriver.

**(1) Upper collet installation**

- Attach collet to lower side of magnetic screwdriver blade and install in the valve stem.

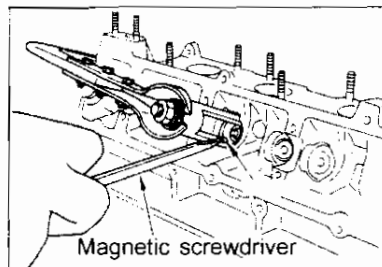

**(2) Lower collet installation**

- Attach collet to upper side of magnetic screwdriver blade and install in the valve stem.
- After valve collet installation lightly tap the stem edge with a plastic hammer to confirm installation.

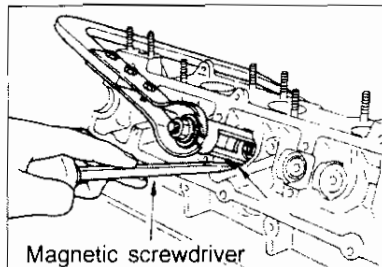

- Install hydraulic valve lifter.
- Tap in camshaft knock pin.

**Knock pin protrusion distance (mm): 5**

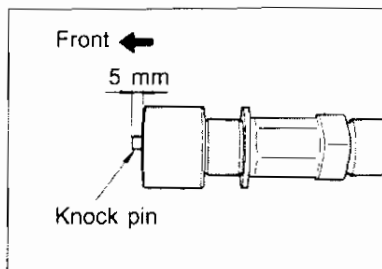

**Camshaft installation**

- Turn camshaft so No. 1 cylinder is at compression T.D.C position (or turn camshaft 60° before or after No. 1 cylinder T.D.C).
- Temporarily tighten No. 1 cam bracket and make sure the thrust section is positioned securely.

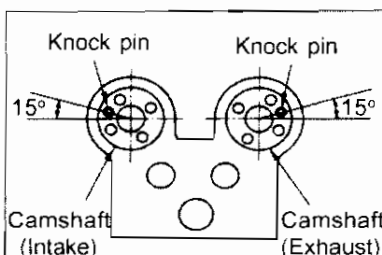

RB25DE ENGINE

- Tighten cam bracket bolts 540° (1.5 turns) gradually in several stages in the sequence shown in the figure on right.

**Tightening torque (kg-m):**                      **0.92 ~ 1.2**

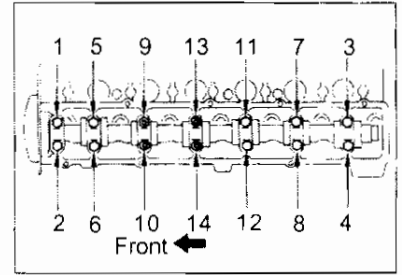

- Install camshaft front oil seal. For detail information refer to "Oil seal" section.

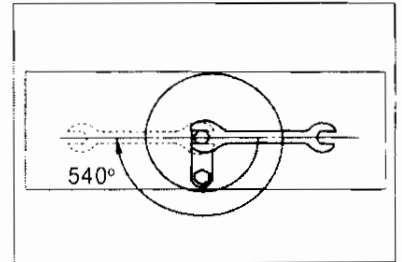

- Install timing belt back plate.

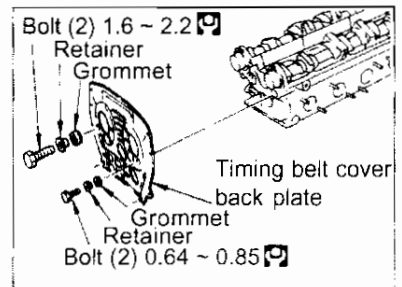

- Align cam pulley to camshaft knock pin to install.

**Tightening torque (kg-m):**                      **1.4 ~ 1.9**

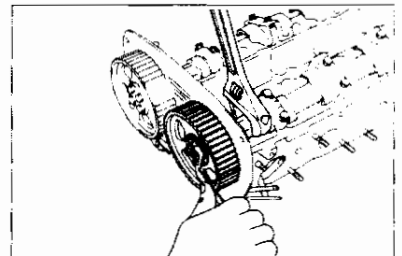

## 11 REMOVE & INSTALL ENGINE

### [Point 1] Release fuel pressure

- After starting engine, remove the fuel pump fuse and run engine until it stops. Consume fuel left in fuel lines by cranking the engine two to three times.
- When it is not possible to start the engine, remove the fuel pump fuse and consume fuel left in fuel lines by cranking engine four to five times.

#### Caution:

The battery may become weak easily, connect booster cables to charged battery.

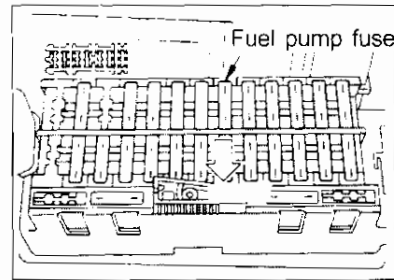

### [Point 2] Accelerator wire adjustment

- Loosen lock nut and provide adequate slack for the accelerator wire. Pull outer case in the direction of the accelerator pedal until throttle drum starts to move (no play in cable). Rotate the lock nut 1 to 1.5 turns to tighten.

**Tightening torque (kg-m): 0.8 ~ 1.0**

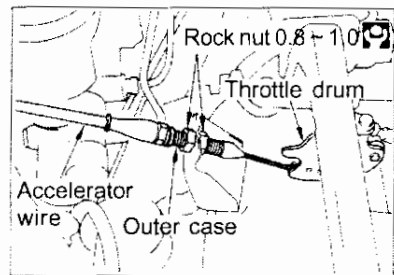

### [Point 3] Engine main harness, ground line separation

- Disconnect the connectors behind the battery for alternator, starter motor and transmission systems.

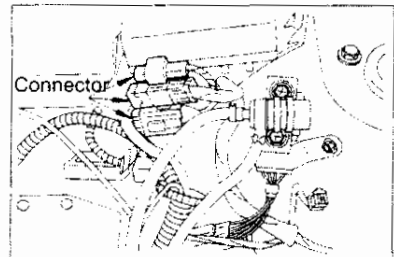

### [Point 4] Air compressor and power steering oil pump movement

- Remove bolts securing each unit to brackets. Leave pipes connected and secure to side of the body with string. Care must be taken not to scratch the body.

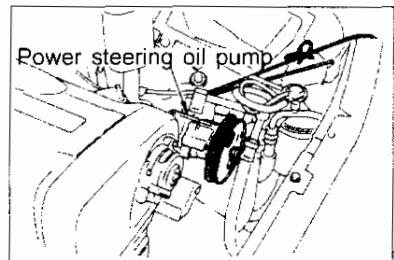

### [Point 5] Power steering oil tube bracket separation

- Remove bolts and separate the power steering oil tube bracket, and move towards the body side.

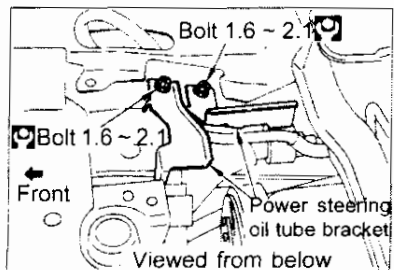

### [Point 6] Front engine mounting nuts removal

- Make sure the engine slings are securely hooked by engine hoist chain and remove front engine mounting nuts.

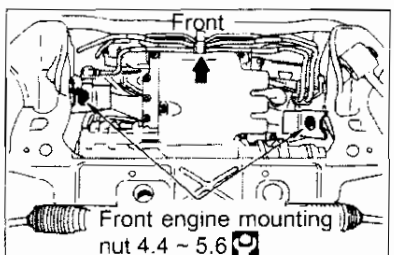

## RB26DETT ENGINE

**[Point 7] Right front engine mounting bracket removal**

- Power steering oil tube will hit the right front engine mounting and it is not possible to shift the engine forward. Therefore remove nuts and remove right engine mounting bracket.

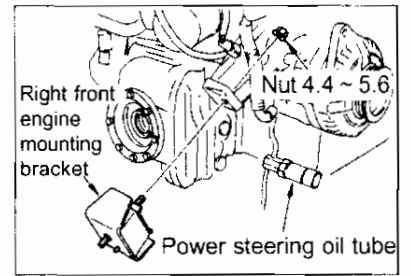
**[Point 8] Remove & install engine ASSY**

- Operate the hoist chain, and change the engine angle gradually to remove the engine. Care must be taken not to interfere with vehicle body.

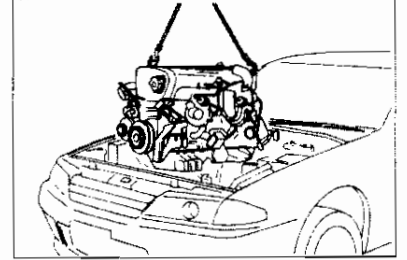

## 11 REMOVE & INSTALL ENGINE

### [Point 1] Release fuel pressure

- After starting engine, remove the fuel pump fuse and run engine until it stops. Consume fuel left in fuel lines by cranking the engine two to three times.
- When it is not possible to start the engine, remove the fuel pump fuse and consume fuel left in fuel lines by cranking engine four to five times.

#### Caution:

The battery may become weak easily, connect booster cables to charged battery.

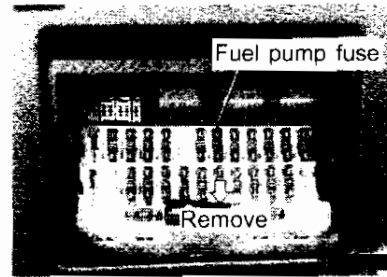

### Transmission jack set (CA18i only)

- Place the transmission jack under the transmission.

### [Point 2] Accelerator wire adjustment

- Loosen lock nut and provide adequate slack for the accelerator wire. Pull outer case in direction of the accelerator pedal until throttle drum starts to move (no play in cable). Rotate the lock nut 1 to 1.5 turns to tighten.

**Tightening torque (kg-m): 0.8 ~ 1.0**

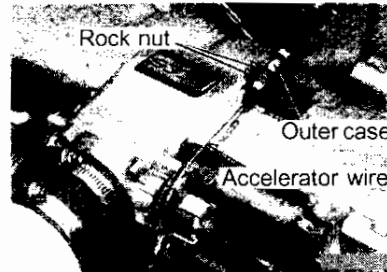

### [Point 3] Engine main harness, ground line separation

- Disconnect the connectors behind the battery for alternator, starter motor and transmission systems.



### [Point 4] Air compressor and power steering oil pump movement

- Remove bolts securing each unit to brackets. Leave pipes connected and secure to side of the body with string. Care must be taken not to scratch the body.

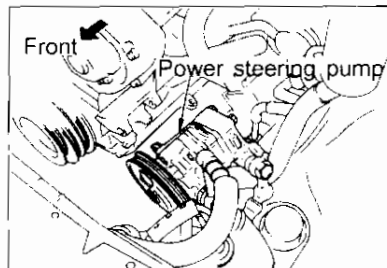

### [Point 5] Remove & Install propella shaft

- Place a cap on the transmission rear seal so the oil will not leak when the propella shaft is removed.



**[Point 6] Remove & install rear engine mounting**

- Support the transmission with transmission jack and remove rear member bolts and rear engine mounting bolts and nuts.

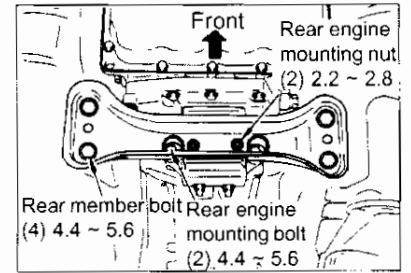
**[Point 7] Front engine mounting nuts removal**

- Make sure the engine slings are securely hooked by engine hoist chain and remove front engine mounting nuts.

**Engine mounting nut tightening torque (kg-m): 4.4 ~ 5.6**

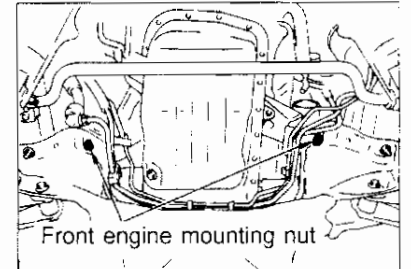
**[Point 8] Remove & install engine ASSY**

- Operate the hoist chain, and change the engine angle gradually to remove the engine. Care must be taken not to interfere with vehicle body.

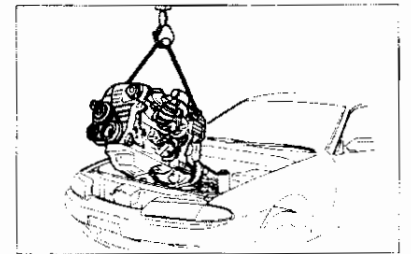

## 11 REMOVE & INSTALL ENGINE

### Standard points

This section describes how to use hoist crane and transmission jack to remove and install the RB25DE engine.

- Drain cooling water completely.
- Remove bonnet.

### Engine bay left side:

- Exhaust gas sensor harness disconnection
- Ground line connector separation
- Air duct, Air cleaner
- Power steering oil pump removal
- Air compressor removal

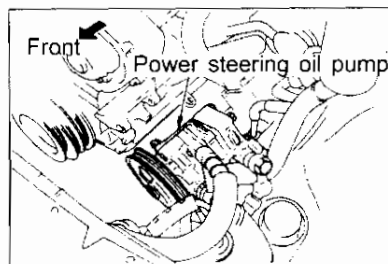

### Engine bay right side:

#### Battery

- Release fuel pressure by selecting "fuel pump relay" in active test mode, and press STOP.



- After starting the engine, remove fuel pump fuse and run engine until it stops. Consume fuel left in fuel line by cranking the engine over two to three times.

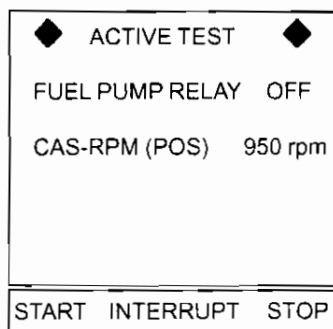

#### Caution:

The battery may become weak easily, connect booster cables to charged battery.

- Accelerator wire separation
- Heater hose
- Vacuum hoses separation

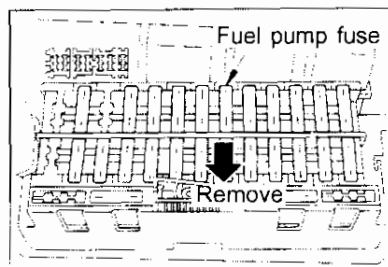

### Engine main harness & ground line separation

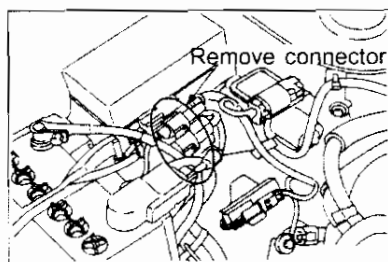

### Engine bay front side:

- Radiator shroud, radiator
- Cooling fan

### Engine bay upper side:

- ECCS harness connectors

## R525DE ENGINE

**Vehicle body, lower side:**

- Engine undercover
- Propella shaft
- Transmission control lever (M/T vehicle), linkage (A/T vehicle)
- Exhaust front tube
- Rear engine mounted bracket

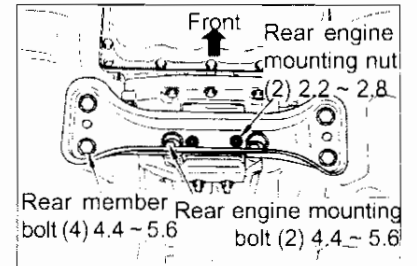

- Right and left engine mounted bracket.

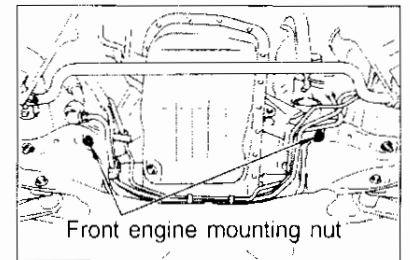
**Remove & install engine ASSY**

- Operate hoist chain and change engine angle gradually. Care must be taken not to interfere with vehicle and remove the engine.

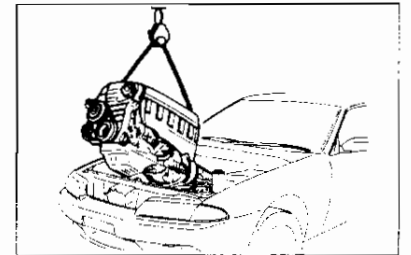

## 12 ENGINE OVERHAUL

This section describes the component disassembly of the engine assembly removed from the vehicle without transmission. It also explains the inspection, replacement of malfunctioning, damages or worn parts and carry out any necessary adjustments and sequential assembly in order to produce a standard engine condition.

### OVERHAUL CAUTIONS

#### (1) Disassembly

- Use correct and suitable tools when possible and make sure to carry out safe procedures.
- Care must be taken with operations on mating surfaces and sliding surfaces to prevent loss of surface accuracy.
- Arrange disassembled parts by making marks to organize for easy faults detection and precise assembly.
- Loosen nuts and bolts in a diagonal direction from outside. Care must be taken to follow the numerical order when indicated.

#### (2) Inspection, repair and replacement

- Replace or repair after completing parts inspection following the inspection procedures. Perform same inspection for the new parts and replace parts as necessary.

#### (3) Assembly

- Always use a torque wrench to tighten nuts and bolts to specific tightening torque.
- Tighten nuts and bolts from centre to outside diagonal direction, gradually in two or three successive stages. Follow the numeric order when indicated.
- Replace gasket, packing, oil seals and O-rings with new ones in principle.
- Clean each part thoroughly and blown off with compressed air. In particular, check that oil and water passages are not clogged or obstructed.
- Care must be taken not to scratch or damage sliding or mating surfaces. Clean off all dust, debris or foreign objects. Lubricate all sliding surface with an adequate coating oil.

## 12-1 DISASSEMBLE &amp; ASSEMBLE CYLINDER BLOCK ASSY

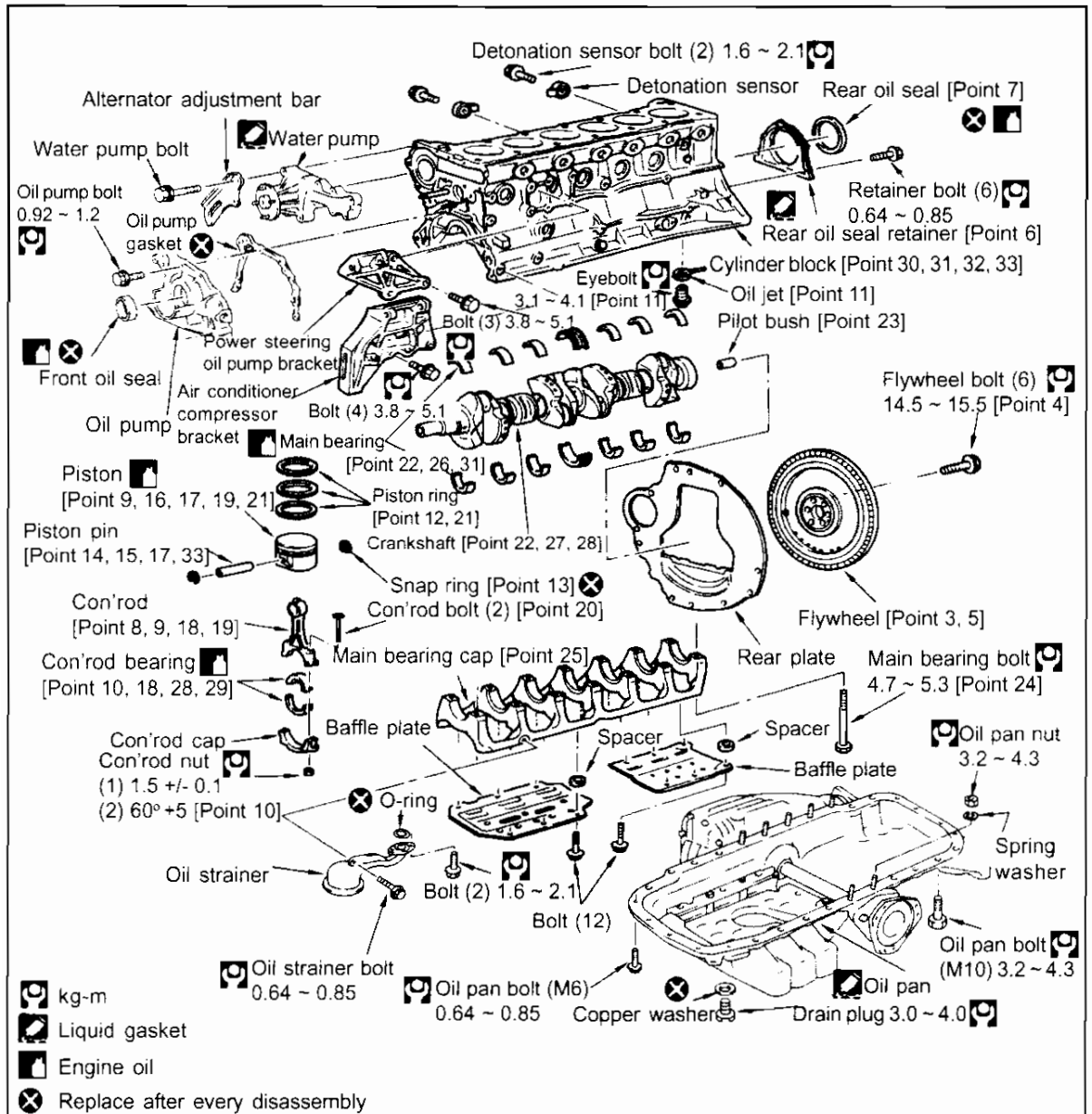
**Additional work required:**

- Drain and refill cooling water [Point 1]
- Remove and install the following parts:
  - Engine
  - Collector
  - Throttle chamber
  - Intake manifold
  - Turbocharger, exhaust manifold
  - Timing belt
  - Cylinder head ASSY
  - Alternator
  - Starter motor
  - Clutch cover, clutch disc
  - Oil pan, oil strainer
  - Water pump
  - Oil pump
  - Oil cooler, oil strainer
  - All harnesses and connectors

Reference: Engine selection assembly

Piston

(1) Piston selection

Grade No.	1	2	3
Cylinder block bore diameter (mm)	Less than 86.010 Greater than 86.00	Less than 86.020 Greater than 86.010	Less than 86.030 Greater than 86.020
Piston diameter (mm)	Less than 85.965 Greater than 85.955	Less than 85.975 Greater than 85.965	Less than 85.985 Greater than 85.975
Piston clearance (mm)	0.035 ~ 0.055		

Service setting parts: Piston and piston pin STD 1, STD 2, STD 3, 0.50S, 1.00S

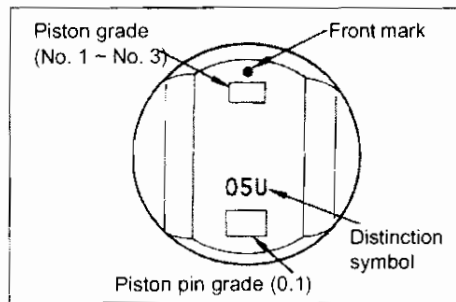

Main bearing

(2) Main bearing selection

Cylinder block bearing housing inner diameter			Less than 58.651 Greater than 58.645	Less than 58.657 Greater than 58.651	Less than 58.663 Greater than 85.657	Less than 58.670 Greater than 58.663
Crank journal diameter	Grade No. stamp		0	1	2	3
Less than 54.975 Greater than 54.969	0	Bearing grade No. Bearing thickness Oil clearance Identification color	STD 0 1.818 ~ 1.821 0.028 / 0.046 Black	STD 1 1.821 ~ 1.824 0.028 / 0.046 Brown	STD 2 1.824 ~ 1.827 0.028 / 0.046 None	STD 3 1.827 ~ 1.830 0.028 / 0.047 Yellow
Less than 54.969 Greater than 54.963	1	Bearing grade No. Bearing thickness Oil clearance Identification color	STD 1 1.821 ~ 1.824 0.028 / 0.046 Brown	STD 2 1.824 ~ 1.827 0.028 / 0.046 None	STD 3 1.827 ~ 1.830 0.028 / 0.046 Yellow	STD 4 1.830 ~ 1.833 0.028 / 0.047 Blue
Less than 54.963 Greater than 54.957	2	Bearing grade No. Bearing thickness Oil clearance Identification color	STD 2 1.824 ~ 1.827 0.028 / 0.046 None	STD 3 1.827 ~ 1.830 0.028 / 0.046 Yellow	STD 4 1.830 ~ 1.833 0.028 / 0.046 Blue	STD 5 1.833 ~ 1.836 0.028 / 0.047 Green
Less than 54.957 Greater than 54.951	3	Bearing grade No. Bearing thickness Oil clearance Identification color	STD 3 1.827 ~ 1.830 0.028 / 0.046 Yellow	STD 4 1.830 ~ 1.833 0.028 / 0.046 Blue	STD 5 1.833 ~ 1.836 0.028 / 0.046 Green	STD 6 1.836 ~ 1.83 90.028 / 0.047 Pink

Service setting parts: STD 0 ~ 6, US 0.25

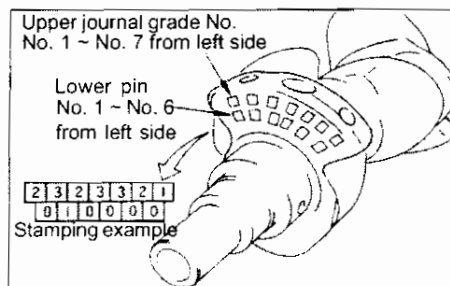
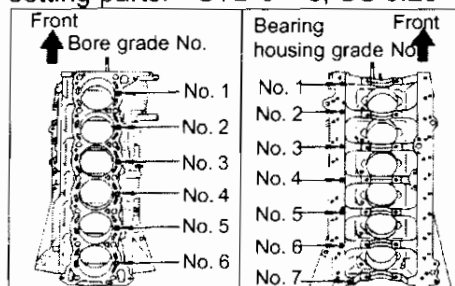

**Piston pin**

(3) Piston pin selection

Grade No.	1	2
<b>Piston pin hole diameter (mm)</b>	21.006 ~ 21.000	21.012 ~ 21.006
<b>Piston pin external diameter (mm)</b>	20.995 ~ 20.989	21.001 ~ 20.995
<b>Piston pin clearance (mm)</b>	0.005 ~ 0.017	

Service setting parts: Piston and piston pin STD 1, STD 2, STD 3, 0.50S, 1.00S

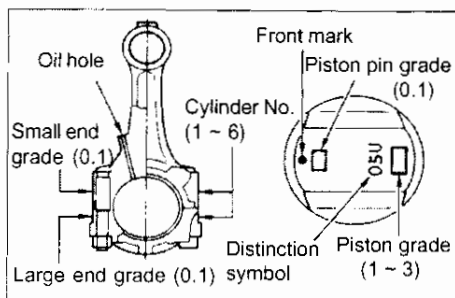

**Con'rod bearing**

(4) Con'rod bearing selection

Connecting rod large end inside diameter		Less than 51.007 Greater than 51.000		Less than 51.013 Greater than 51.007	
Crank pin diameter	Grade No. stamp	0		1	
<b>Less than 47.974 Greater than 47.968</b>	0	Bearing grade No.	STD 0	Bearing grade No.	STD 1
		Bearing thickness (mm)	1.500 ~ 1.503	Bearing thickness (mm)	1.503 ~ 1.506
		Oil clearance (mm)	0.020 / 0.039	Oil clearance (mm)	0.020 / 0.039
		Identification color	None	Identification color	Brown
<b>Less than 47.968 Greater than 47.961</b>	1	Bearing grade No.	STD 1	Bearing grade No.	STD 2
		Bearing thickness (mm)	1.503 ~ 1.506	Bearing thickness (mm)	1.506 ~ 1.509
		Oil clearance (mm)	0.020 / 0.040	Oil clearance (mm)	0.021 / 0.040
		Identification color	Brown	Identification color	Green

Service setting parts: US 0.08, US 0.12, US 0.25

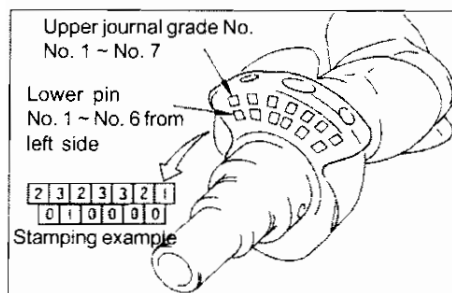

## RB26DETT ENGINE

**[Point 1] Drain & refill cooling water****Draining**

- Drain cooling water in the cylinder block completely from the drain plug.

**Refilling**

- Refer to the section "cooling water" for detailed instruction.

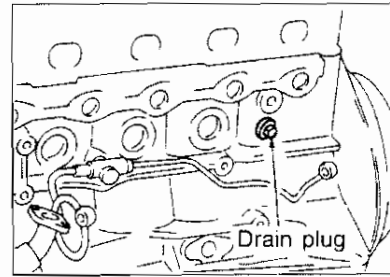
**[Point 2] Remove & install engine stand**

- Install the engine sub attachment using 6 bolts to engine mounting bracket on right side of the engine.

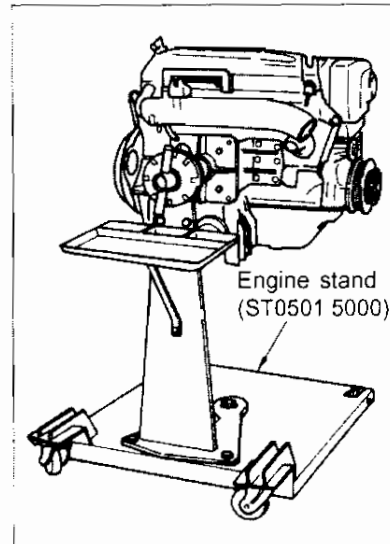
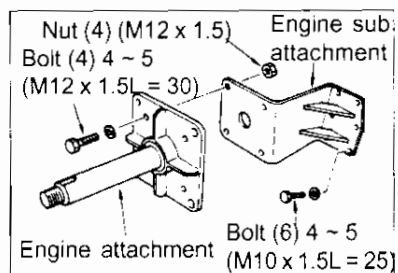
**[Point 3] Flywheel run-out**

- Set dial gauge to flywheel where it contacts clutch.
- Turn the flywheel and measure the run-out.

**Run-out limit (mm): 0.10**

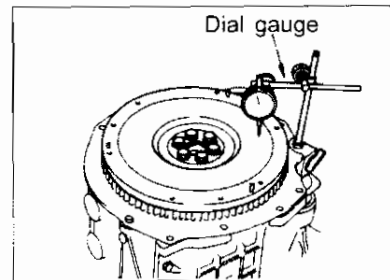
**[Point 4] Remove & install flywheel****Removal**

- Use ring gear stopper to fix flywheel and remove.

**Installation**

- Coat the thread and flange of bolts with engine oil after installing the bolts.
- after tightening the flywheel bolts, use ring gear stopper to secure flywheel and tighten bolts.

**Flywheel bolt tightening torque (kg-m): 14.5 ~ 15.5**

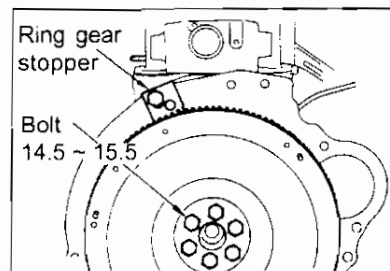
**[Point 5] Flywheel knock pin installation**

- Insert the flywheel knock pin so the pin protrudes 8 to 8.5 mm.

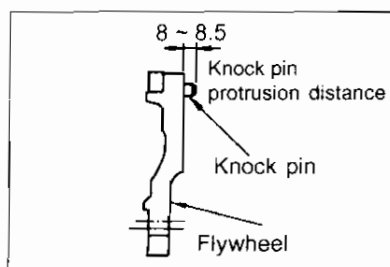



**[Point 6] Remove & install rear oil seal retainer****Removal**

- Insert a screwdriver in the gap between main bearing cap and rear oil seal retainer to remove seal.

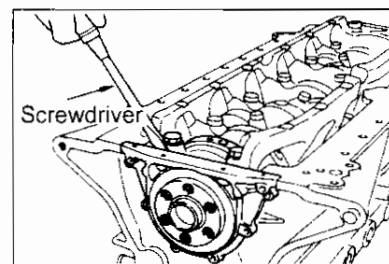
**Cleaning**

- Use scraper to remove liquid gasket
- Clean the cylinder block side in the same way.
- Wipe mating surface with white gasoline.

**Caution:**

Also remove liquid gasket in the grooves.

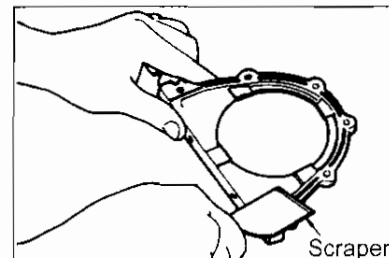
**Installation**

- Apply liquid gasket and install unit within 5 minutes.
- Cut nozzle end of the liquid gasket (KP510 00150) tube as shown in the figure on right. Use tube presser for application.

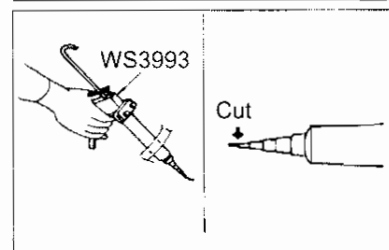

- Apply liquid gasket continuously to rear oil seal retainer.

**Caution:**

Make sure liquid gasket width is 2.0 ~ 3.0 mm.

Refill engine oil and start the engine 30 minutes after assembly is completed.

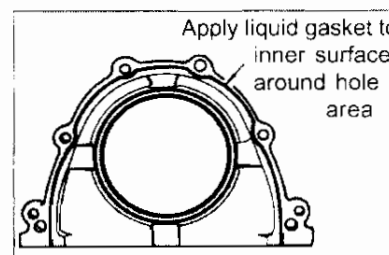

- Align the rear oil seal retainer with dowel pin to install.
- Tighten 6 bolts uniformly.

**Rear oil seal retainer bolt tightening torque (kg-m):**

**0.64 ~ 0.85**

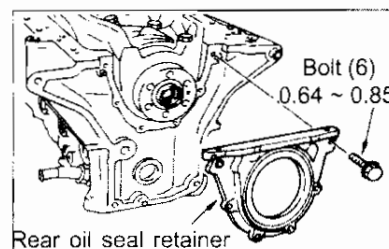
**[Point 7] Remove & install rear oil seal****Removal**

- Use a tool such as screwdriver to remove the seal.

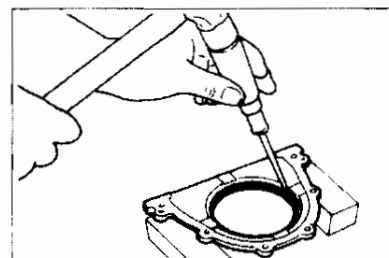
**Installation**

- Care must be taken not to scratch or damage the oil seal perimeter area. Use oil seal drift (Outside diameter: 100 mm) to install new oil seal.
- Apply a coat of oil or chassis grease to oil seal lip area.

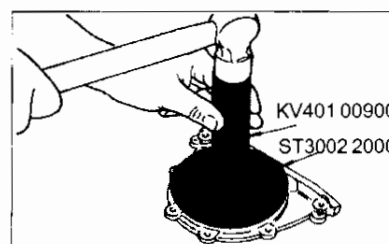

## RB26DETT ENGINE

**[Point 8] Con'rod side clearance inspection**

- Use thickness gauge to measure the thrust clearance between the con'rod and the crank arm.

**Standard value (mm):** 0.2 ~ 0.3  
**Limit value (mm):** 0.4

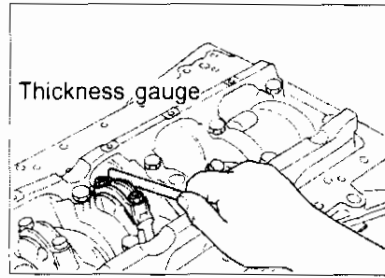
**[Point 9] Remove & install piston con'rod ASSY**

- Use a tool such as hammer handle to press the unit to cylinder head side.

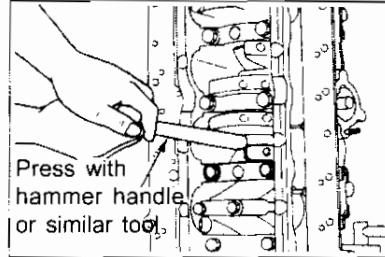
**Installation**

- Set the crank pin at B.D.C (Bottom dead center) position.
- Coat cylinder bore, crank pin and piston with engine oil.
- Assemble piston with front mark on piston head facing the front of engine.
- Use a piston ring compressor to install the piston and the con'rod assembly in cylinder block.

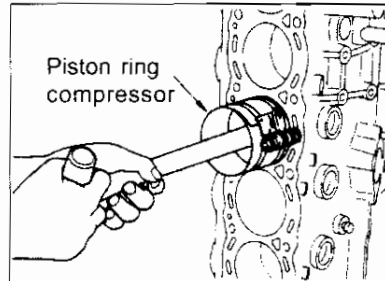
**Caution:**

Care must be taken not to strike or deform oil jet pipe with large end of connecting rod when installing.

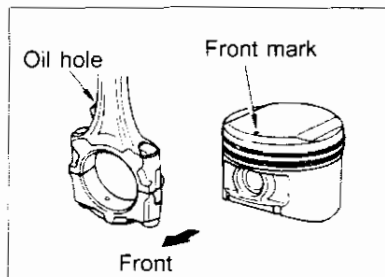
**Con'rod nut tightening**

- Apply engine oil to con'rod and the nuts before assembly.
- Tighten nuts in two or three stages.

**1st time Torque wrench (kg-m):** 1.4 ~ 1.6

**2nd time Angle wrench (°):** 60 ~ 65

**Caution:**

Do not visually measure the tightening torque if angle wrench is not available.

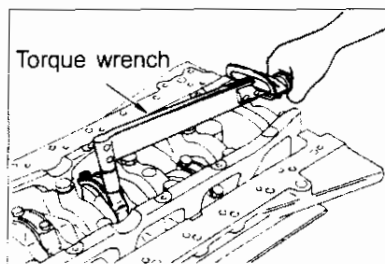
**[Point 10] Install con'rod bearing**

- Apply engine oil to bearing surface when installing con'rod bearing. Do not apply engine oil to rear surface of bearing, clean this area.
- Align con'rod bearing retainer notches and install (left side).
- Make sure the con'rod body oil hole and the bearing oil hole is aligned.

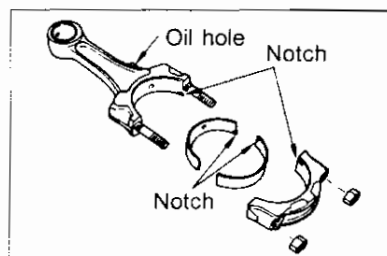

**[Point 11] Install oil jet**

- Set the oil jet position securely and check that it does not interfere with piston. If oil jet pipe contacts piston or is bent, replace it with new part.

**Oil jet tightening torque (kg-m):** 3.1 ~ 4.1

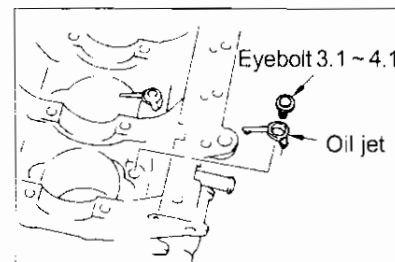
**[Point 12] Remove & install piston ring**  
**Removal**

- Use piston ring expander to remove rings.

**Caution:**

Care must be taken not to scratch piston.

**Installation**

- Use piston ring expander to install rings.

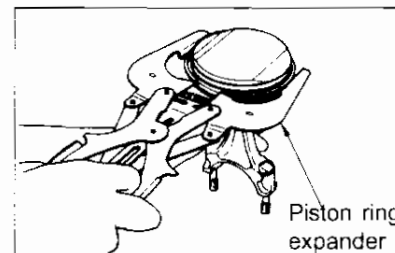

- The stamped marks on top and second piston ring openings must face up.

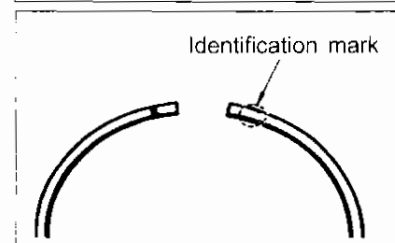

- Position the piston rings as shown in the figure on right to install.

**Caution:**

Care must be taken not to scratch piston.

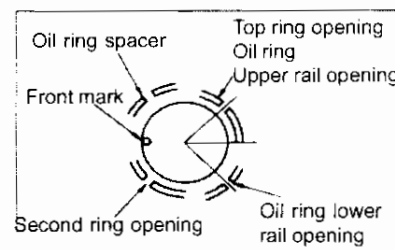
**[Point 13] Remove & install snap ring**  
**Removal**

- Use snap ring pliers to remove rings.

**Installation**

- Use snap ring pliers and install rings securely in groove.

**Caution:**

Always replace snap rings with new ones.

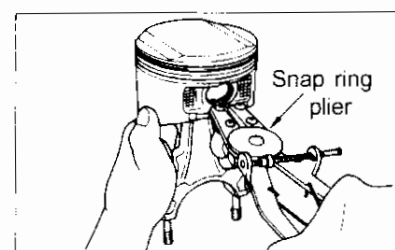
**[Point 14] Remove & install piston pin**

- Use a heat gun to heat piston to 60 ~ 70°C when removing and installing piston pin.

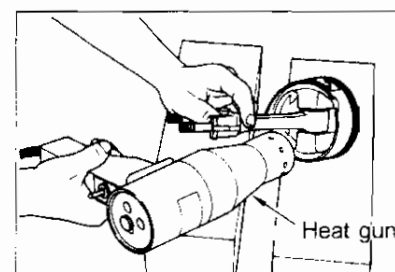

- Place suitable tool against piston pin and press or use plastic hammer.
- Apply plenty of engine oil to pin, pin hole and con'rod small hole.

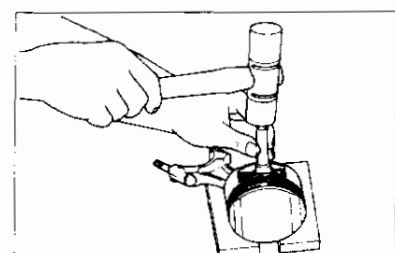

**Piston pin press-fit**

- Place the piston front mark so the con'rod oil hole faces right side of the engine (left side when viewed from front) and press-fit.

**Caution:**

Press-fit the piston pin from the front of piston to the rear side of piston.

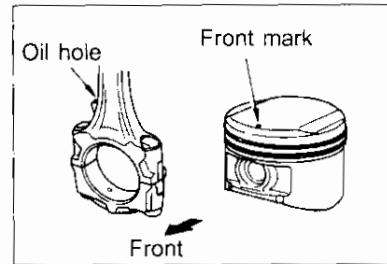
**[Point 15] Piston pin inspection**

- Use the micrometer to measure outside diameter of piston pin.

**Standard unit (mm):** 20.989 ~ 21.001

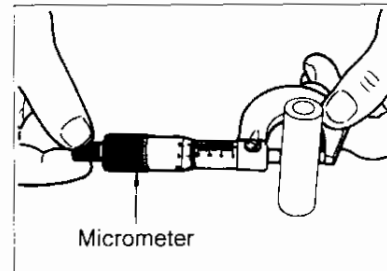
**[Point 16] Piston inspection**

- Use micrometer to measure outside piston skirt diameter.

**Measuring point Distance from bottom (mm):** 13

**Standard (mm):** 85.955 ~ 85.985

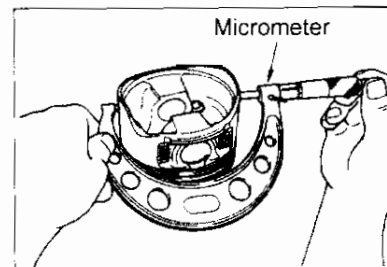

- Use inside micrometer to measure inside diameter of piston pin hole.

**Standard value (mm):** 20.987 ~ 20.999

- Five types of pistons are available for service (STD 1, STD 2, STD 3, 0.50S, 1.00S).

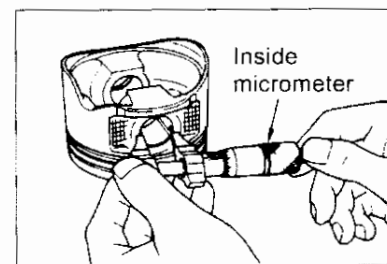
**[Point 17] Piston pin clearance inspection**

- Piston pin clearance is the figure obtained by subtracting the piston pin outside diameter [Point 15] from the piston pin hole inside diameter [Point 16].

**Piston clearance at normal temperature (20°C):**

0 ~ -0.004

**[Point 18] Con'rod inspection****Bend and torsion inspection**

- Measure the bend and torsion with con'rod aligner.

**Bend limit (mm):** 0.15

**Torsion limit (mm):** 0.3

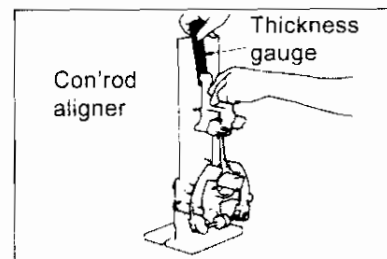
**Small end inside diameter inspection**

**Standard value (mm):** 21.000 ~ 21.012

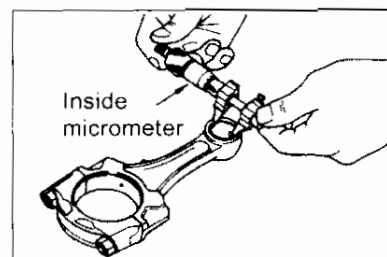

**Con'rod bearing interior diameter inspection**

- Install con'rod bearing in con'rod and cap. Tighten con'rod nuts to specified torque and measure con'rod bearing interior diameter.

<b>Con'rod nut tightening torque</b>	1st time	Torque wrench (kg-m)	1.4 ~ 1.6
	2nd time	Angle wrench ( ° )	60 ~ 65
<b>Standard value</b>	47.989 ~ 48.007		

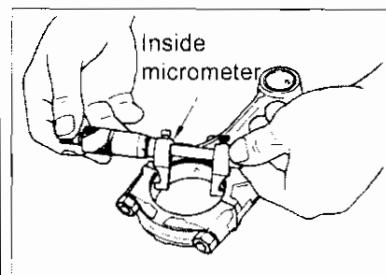

**[Point 19] Con'rod small end bushing clearance**

- The measurement difference of the small end inside diameter [Point 18] and outside diameter of piston pin [Point 15] is the bushing clearance (full float type).

**Bush clearance standard value (mm): 0.005 ~ 0.017**

- The con'rod small end and piston pin outside diameter are separated into two grades at the factory. Make sure that the grades (0.1) conform for both parts because the rod and pin are selected and fitted according to bushing clearance.

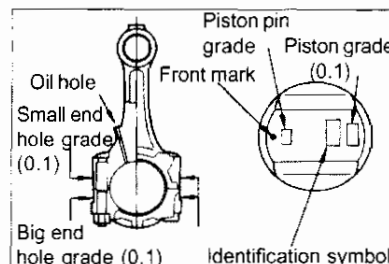

**[Point 20] Con'rod cap bolt**

- Con'rod cap bolts have grooves to prevent it from disengaging.
- For this reason do not tap the ends to remove bolts.

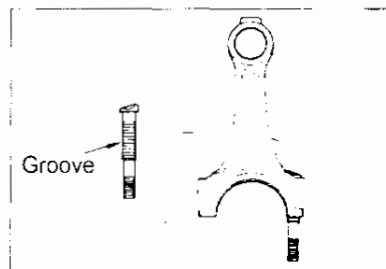

**[Point 21] Piston ring end gap and side clearance**

**Ring end gap inspection**

- Use a piston to press the piston ring into the middle of the cylinder and measure the gap.

Item	Top ring	Second ring	Oil ring
<b>Standard value (mm)</b>	Bore grade 1, 2, 3: 0.24 ~ 0.34	0.42 ~ 0.57	0.20 ~ 0.60

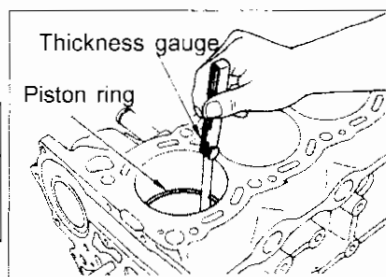

**Side clearance inspection**

- Measure the clearance between the piston ring and the piston ring groove.

Item	Top ring	Second ring	Oil ring
<b>Standard value (mm)</b>	0.040 ~ 0.075	0.030 ~ 0.065	0.065 ~ 0.135

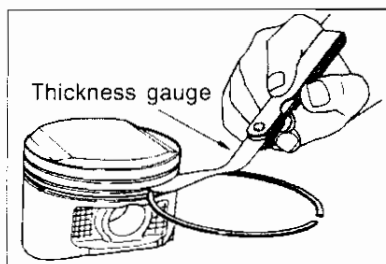

- Three types of piston rings (STD, 0.50S, 1.00S) are available for service.

**[Point 22] Crankshaft thrust clearance inspection**

- Use a thickness gauge to measure the clearance between the thrust bearing (No. 4 bearing) and the crank arm when moving the crankshaft towards front and rear of the engine.

**Standard value (mm):** 0.05 ~ 0.18

**Limit (mm):** 0.3

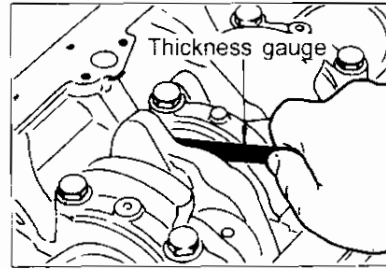
**[Point 23] Remove & install pilot bushing****Removal**

- Use a pilot bearing puller to remove pilot bushing.

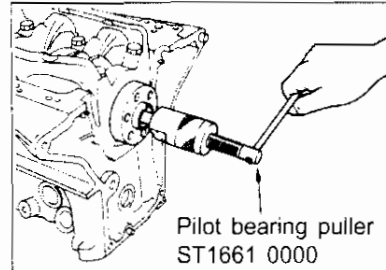
**Installation**

- The pilot bushing installation position is as shown in the figure on right.

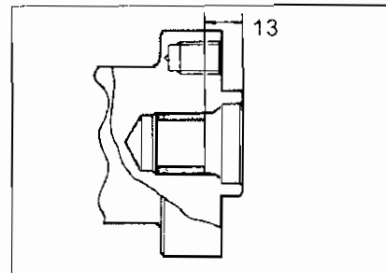
**[Point 24] Remove & install main bearing bolts****Removal**

- Remove bearing bolts in reverse order of sequence shown in the figure on right.

**Installation**

- Tighten the bolts to specified torque in two to three stages in the sequence shown in the figure on the right. Make sure the crankshaft turns smoothly after tightening the bolts to specified torque.

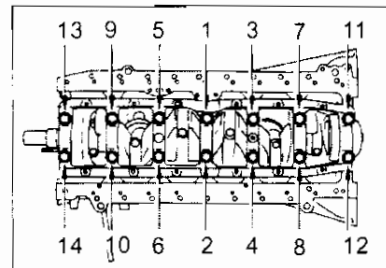

**Main bearing bolt tightening torque (kg-m):** 4.7 ~ 5.3

**Caution:**

Apply engine oil to the bolt threads and bolt seats when tightening the bolts.

**[Point 25] Remove & install main bearing cap****Removal**

- Use tools such as screwdriver to pry the bearing caps open.

**Caution:**

Care must be taken not to scratch the oil pan rail surface.

**Installation**

- Check the front and rear position and fit onto cylinder block by lightly tapping it in a number of locations with a copper hammer.

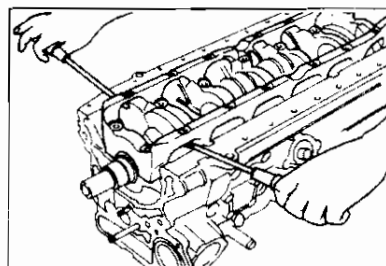

**[Point 26] Main bearing inspection**

- The bearing end should protrude when installed in main bearing cap or cylinder block.

This protrusion is called the crush height.

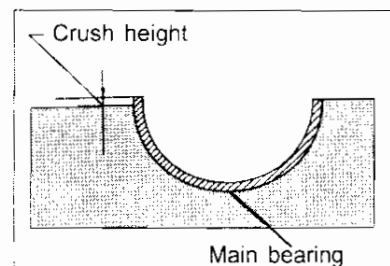
**[Point 27] Crankshaft inspection****Out-of-round and taper inspection**

- Use micrometer to measure each journal (No. 1 ~ 7) and each pin (No. 1 ~ 6) in four locations shown in the figure on right.
- The out-of-round value is the difference of the dimensions in directions A and B.
- The taper value is the difference of the dimensions measured at points 1 and 2.

Out-of-round and taper limit (mm): **0.005**

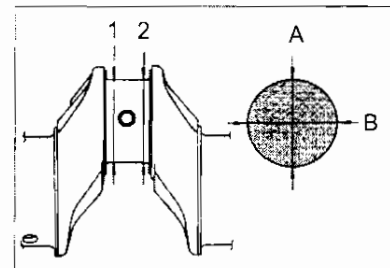
**Pin and journal inspections**

- Use micrometer to measure pin and journal diameters.

Pin diameter standard value (mm): **47.961 ~ 47.974**

Journal diameter standard value (mm): **54.951 ~ 54.975**

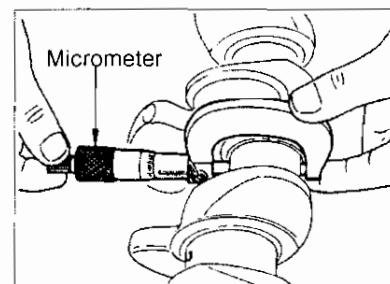
**Curve inspection**

- Use V-blocks on a fixed surface and support journals on both ends of crankshaft (No. 1 and No. 7).
- Position the dial gauge vertically on middle of No. 4 journal as shown in the figure on the right.
- Turn crankshaft by hand and read dial gauge movement.
- The Run-out is equal to half of dial gauge movement.

Limit value (mm): **0.05**

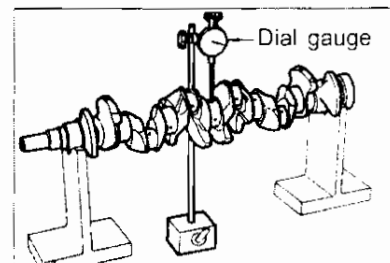
**[Point 28] Con'rod bearing oil clearance inspection****(A) Using inside micrometer and micrometer**

- The oil clearance can be calculated from connecting rod bearing inside diameter and the crankshaft pin diameter measured in [Point 18] and [Point 27].

(Oil clearance) =

(Bearing inside diameter) - (crankshaft pin diameter)

Standard value (mm): **0.020 ~ 0.040**

Limit value (mm): **0.090**

- If the oil clearance exceeds the limit, refer to [Point 29] and select the appropriate bearing.

**(B) Using plastigauge**

- Remove any dust from crankshaft pins and bearing surfaces.
- Cut off a piece of plastigauge slightly shorter than the bearing width. Place the plastigauge on the crankshaft in direction of axis. Care must be taken not to place on the oil hole.
- Assemble connecting rod bearing in connecting rod cap and tighten connecting rod nuts to specified torque.

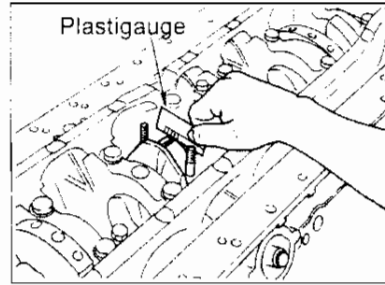

<b>Con'rod nut tightening torque</b>	1st time	Torque wrench (kg-m)	1.4 ~ 1.6
	2nd time	Angle wrench (°)	60 ~ 65

- Remove con'rod cap and bearing and measure plastigauge width with a plastigauge scale.

**Caution:**

Never turn the crankshaft or connecting rod while plastigauge is being inserted.

If oil clearance exceeds the limit value, refer to [Point 29] and select the appropriate bearing.

**[Point 29] Con'rod bearing selection and engaging**

- Select the correct sized bearing as the con'rod bearing prevents fluctuation in the oil clearance. Three bearing thicknesses are available to fit the inside diameter of the big end of the con'rod and the crank pin diameter gauge.
- When replacing the con'rod bearing, check big end inside diameter gauge (indicated on the opposite side of the con'rod hole) and the pin diameter gauge (indicated on crankshaft No. 1 counterweight front surface).

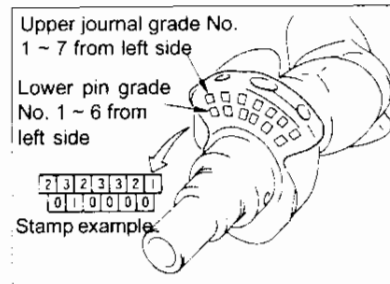
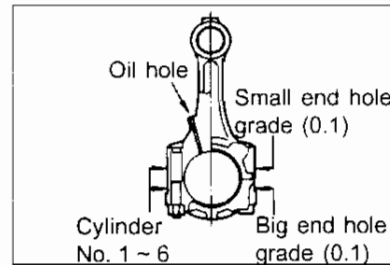

**Con'rod bearing selection chart**

Con'rod large end inside diameter		Less than 51.007 Greater than 51.000		Less than 51.013 Greater than 51.007	
Crank pin diameter	Grade No. stamp	0		1	
Less than 47.974 Greater than 47.968	0	Bearing grade No. Bearing thickness (mm) Oil clearance (mm) Identification colour	STD 0 1.500 ~ 1.503 0.020 / 0.039 None	Bearing grade No. Bearing thickness (mm) Oil clearance (mm) Identification colour	STD 1 1.503 ~ 1.506 0.020 / 0.039 Brown
Less than 47.968 Greater than 47.961	1	Bearing grade No. Bearing thickness (mm) Oil clearance (mm) Identification colour	STD 1 1.503 ~ 1.506 0.020 / 0.040 Brown	Bearing grade No. Bearing thickness (mm) Oil clearance (mm) Identification colour	STD 2 1.506 ~ 1.509 0.021 / 0.040 Green



## RB26DETT ENGINE

- When using undersize bearings, measure bearing inside diameter when bearing is installed. Grind pin so oil clearance conforms to specific value.

**Bearing undersize chart**

Size	Thickness (mm)	Grade No.
US0.08	1.541 / 1.549	8
US0.12	1.561 / 1.569	12
US0.25	1.626 / 1.634	25

**Caution:**

Care must be taken not to scratch fillet roll when the crank pin is being grounded to use undersize bearing.

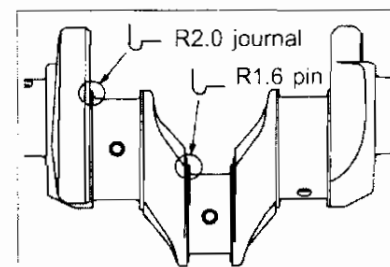
**[Point 30] Main bearing oil clearance****Using bore gauge and micrometer (Method A)**

- Install main bearing in cylinder block and attach bearing cap. Tighten bearing cap bolts to specified torque and measure bearing inside diameter.

**Bearing cap bolt tightening torque (kg-m): 4.7 ~ 5.3**

- The oil clearance distance can be calculated from the values for outside diameter of the crank journal measured in [Point 27].

**(Oil clearance) =**

**(Bearing inside diameter) - (Crankshaft outside diameter)**

**Standard value (mm): 0.028 ~ 0.047**

**Limit value (mm): 0.090**

- If oil clearance exceeds the limit value refer to [Point 31] to select suitable bearing.

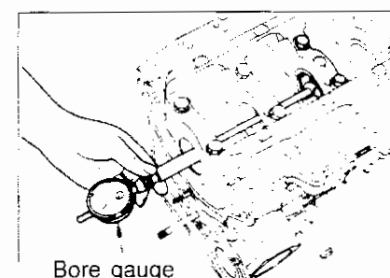

Bore gauge

**Using plastic gauge (Method B)**

- Remove all dust and oil from each crankshaft journal and bearing surfaces.
- Cut a piece of plastigauge slightly shorter than the bearing gauge width. Place a plastigauge on crankshaft in direction of axis, care must be taken not to place on oil hole.
- Assemble the main bearing and bearing cap and tighten cap bolts to the specified torque.

**Bearing cap bolt tightening torque (kg-m): 4.7 ~ 5.3**

- Remove bearing cap and the bearing. Measure plastigauge width on plastigauge scale.

**Caution:**

Do not turn crankshaft while plastigauge is being inserted.

If excessive bearing clearance still exists, use a thicker main bearing or undersized bearing so that the specified bearing clearance is obtained when measured by method A as well.

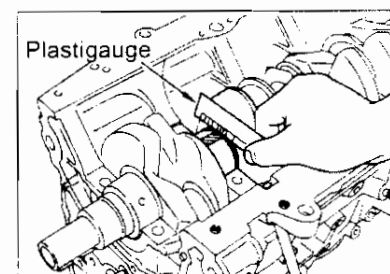

Plastigauge

**[Point 31] Main bearing selection and engagement**

- Select correct sized bearing as the main bearing prevents fluctuation in the oil clearance. Seven different bearing thicknesses are available to fit the cylinder block bearing housing and crank journal diameter grades.

Note:

Selection engagement is performed only for standard size.

- Check the bearing grade (indicated on bottom face of the cylinder block) and journal diameter grade (indicated on crankshaft No. 1 counterweight front surface) when replacing the main bearing.
- Select main bearing with proper thickness according to the following table.

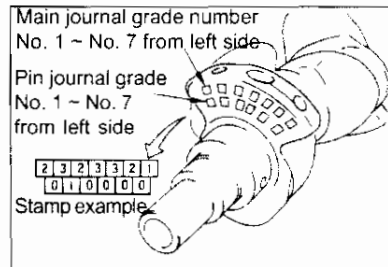
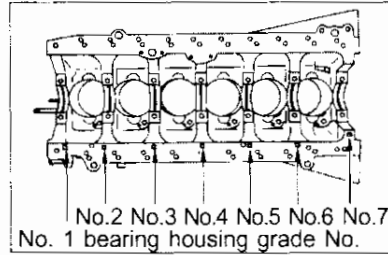

Cylinder block bearing housing inner diameter			Less than 58.651 Greater than 58.645	Less than 58.657 Greater than 58.651	Less than 58.663 Greater than 85.657	Less than 58.670 Greater than 58.663
Crank journal diameter	Grade No. stamp		0	1	2	3
Less than 54.975 Greater than 54.969	0	Bearing grade No. Bearing thickness Oil clearance Identification color	STD 0 1.818 ~ 1.821 0.028 / 0.046 Black	STD 1 1.821 ~ 1.824 0.028 / 0.046 Brown	STD 2 1.824 ~ 1.827 0.028 / 0.046 None	STD 3 1.827 ~ 1.830 0.028 / 0.047 Yellow
Less than 54.969 Greater than 54.963	1	Bearing grade No. Bearing thickness Oil clearance Identification color	STD 1 1.821 ~ 1.824 0.028 / 0.046 Brown	STD 2 1.824 ~ 1.827 0.028 / 0.046 None	STD 3 1.827 ~ 1.830 0.028 / 0.046 Yellow	STD 4 1.830 ~ 1.833 0.028 / 0.047 Blue
Less than 54.963 Greater than 54.957	2	Bearing grade No. Bearing thickness Oil clearance Identification color	STD 2 1.824 ~ 1.827 0.028 / 0.046 None	STD 3 1.827 ~ 1.830 0.028 / 0.046 Yellow	STD 4 1.830 ~ 1.833 0.028 / 0.046 Blue	STD 5 1.833 ~ 1.836 0.028 / 0.047 Green
Less than 54.957 Greater than 54.951	3	Bearing grade No. Bearing thickness Oil clearance Identification color	STD 3 1.827 ~ 1.830 0.028 / 0.046 Yellow	STD 4 1.830 ~ 1.833 0.028 / 0.046 Blue	STD 5 1.833 ~ 1.836 0.028 / 0.046 Green	STD 6 1.836 ~ 1.83 90.028 / 0.047 Pink

- When using undersized bearings, measure bearing inside diameter when bearing is installed and grind journal so oil clearance conforms to specified clearance.

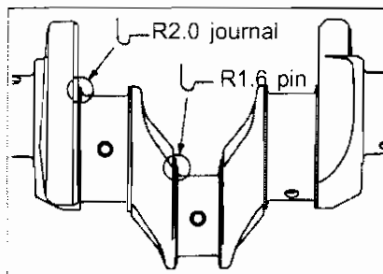

Size	Thickness (mm)	Grade No.
US0.25	1.950 / 1.958	25

**Caution:**

When crankshaft journal is being ground for use with undersize bearings, do not scratch the fillet roll.

**[Point 32] Cylinder block inspection and correction**

- Remove all oil and water deposits, gasket, seal material and carbon from cylinder block.

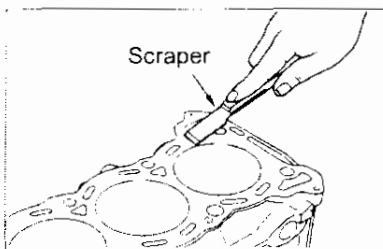

### Upper surface distortion and wear inspection

- Clean upper face of the cylinder block and measure the distortion in six directions.

**Limit (mm):** 0.1

- If the distortion exceeds the specified limit, resurface the face with surface grinder or replace block if necessary.

### Cylinder inside diameter inspection

- Use bore gauge to measure cylinder bore for bear, out-of-round and taper. Measure in three vertical locations (A, B & C) and two directions (X & Y) for a total of six locations.

<b>Cylinder inside diameter standard (mm)</b>	86.000 ~ 86.050
<b>Wear limit (mm)</b>	0.2
<b>Out-of-round limit (mm)</b>	0.015
<b>Taper limit (mm)</b>	0.010

- (1) Out-of-round measurement is the difference of measurements in two directions (X & Y).
- (2) Taper is the difference of measurement at top and bottom (A & C).

- Perform honing or boring when abnormality is found.

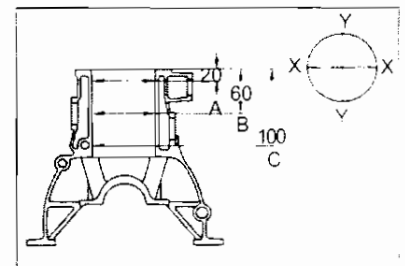
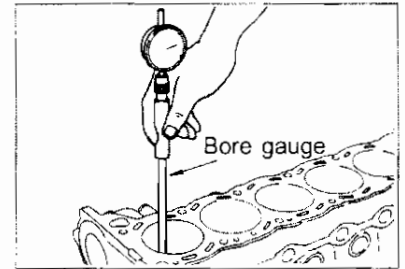

### Cylinder honing

- There are three types of oversize pistons, STD (Standard +0.02), OS (0.5) and OS (0.1). When oversize pistons are used, hone the cylinder so the clearance between the piston and the cylinder conforms to the specified value described in [Point 33]. Oversize piston rings must be used that fit the oversize piston.

#### [Point 33] Piston and cylinder bore clearance

- The clearance can be calculated from the measured values for the piston skirt outside diameter [Point 16] and cylinder inside diameter [Point 32] (X direction B location).

$$(\text{Clearance}) = (\text{Cylinder inside diameter}) - (\text{Piston skirt outside diameter})$$

**Standard at normal temperature (mm):** 0.035 ~ 0.055

## 12 ENGINE OVERHAUL

### OVERHAUL CAUTIONS

#### (1) Disassembly

- Use correct and suitable tools when possible and make sure to carry out safe procedures.
- Care must be taken with operations on mating surfaces and sliding surfaces to prevent loss of surface accuracy.
- Arrange disassembled parts by making marks to organize for easy faults detection and precise assembly.
- Loosen nuts and bolts in a diagonal direction from outside. Care must be taken to follow the numerical order when indicated.

#### (2) Inspection, repair and replacement

- Replace or repair after completing parts inspection following the inspection procedures. Perform same inspection for the new parts and replace parts as necessary.

#### (3) Assembly

- Always use a torque wrench to tighten nuts and bolts to specific tightening torque.
- Tighten nuts and bolts from centre to outside diagonal direction, gradually in two or three successive stages. Follow the numeric order when indicated.
- Replace gasket, packing, oil seals and O-rings with new ones in principle.
- Clean each part thoroughly and blown off with compressed air. In particular, check that oil and water passages are not clogged or obstructed.
- Care must be taken not to scratch or damage sliding or mating surfaces. Clean off all dust, debris or foreign objects. Lubricate all sliding surface with an adequate coating oil.

12-1 CYLINDER BLOCK DISASSEMBLE, ASSEMBLE & INSPECTION

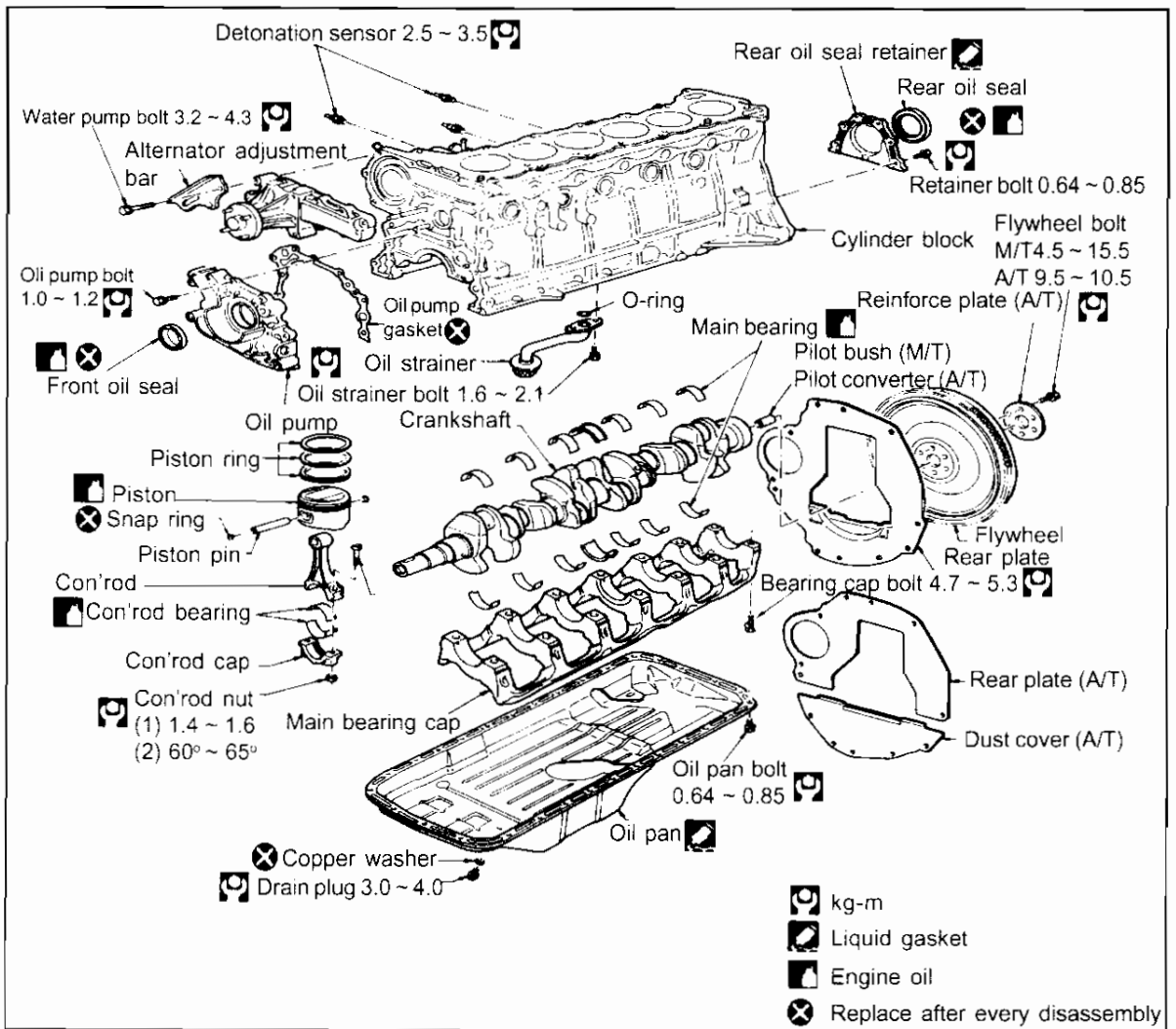

Reference: Engine selection assembly

Piston

(1) Piston selection

Grade No.	1	2	3
<b>Cylinder block bore diameter (mm)</b>	Less than 86.010 Greater than 86.00	Less than 86.020 Greater than 86.010	Less than 86.030 Greater than 86.020
<b>Piston diameter (mm)</b>	Less than 85.965 Greater than 85.955	Less than 85.975 Greater than 85.965	Less than 85.985 Greater than 85.975
<b>Piston clearance (mm)</b>	0.035 ~ 0.055		

Service setting parts: Piston and piston pin STD 1, STD 2, STD 3, 0.50S, 1.00S

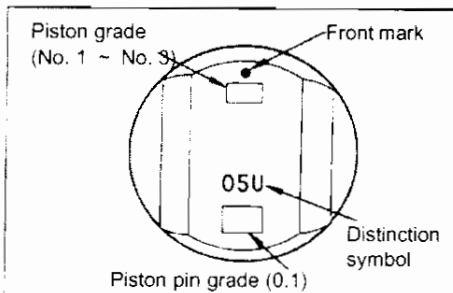

**Main bearing**

(2) Main bearing selection

Cylinder block bearing housing inner diameter			Less than 58.654 Greater than 58.645	Less than 58.663 Greater than 58.654	Less than 58.672 Greater than 58.663
Crank journal diameter	Grade No. stamp		0	1	2
Less than 54.975 Greater than 54.967	0	Bearing grade No. Bearing thickness Oil clearance Identification colour	STD 0 1.825/1.821 0.020/0.045 Black	STD 1 1.829/1.825 0.021/0.046 Brown	STD 2 1.833/1.829 0.022/0.047 None
Less than 54.967 Greater than 54.959	1	Bearing grade No. Bearing thickness Oil clearance Identification colour	STD 1 1.829/1.825 0.020/0.045 Brown	STD 2 1.833/1.829 0.021/0.046 None	STD 3 1.837/1.833 0.022/0.047 Yellow
Less than 54.959 Greater than 54.951	2	Bearing grade No. Bearing thickness Oil clearance Identification colour	STD 2 1.833/1.829 0.020/0.045 None	STD 3 1.837/1.833 0.022/0.046 Yellow	STD 4 1.841/0.837 0.022/0.047 Blue

- No. 1 ~ No. 3 No. 5 ~ No. 7 Upper side (with groove, width 19 mm)
- No. 1 ~ No. 3 No. 5 ~ No. 7 Lower side (without groove, width 19 mm)
- No. 4 Upper side (thrust metal, with groove, width 26.9 mm)
- No. 4 Lower side (thrust metal, without groove, width 26.9 mm)

**Crank journal oil clearance (mm): 0.020 ~ 0.047**

Service setting parts: STD 0 ~ 6, US 0.25

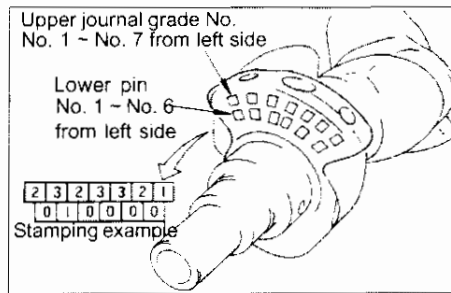
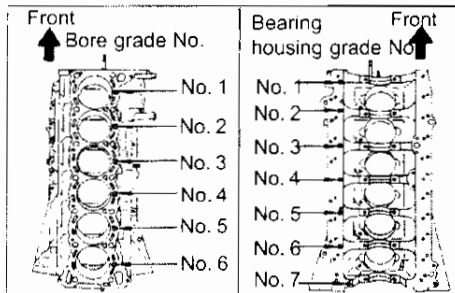

**Piston pin**

(3) Piston pin selection

Grade No.	1	2
Piston pin hole diameter (mm)	20.987 ~ 20.993	20.993 ~ 20.999
Piston pin external diameter (mm)	20.995 ~ 20.989	21.001 ~ 20.995
Piston pin clearance (mm)	0 ~ -0.004	

Service setting parts: Piston and piston pin STD 1, STD 2, STD 3, 0.50S, 1.00S

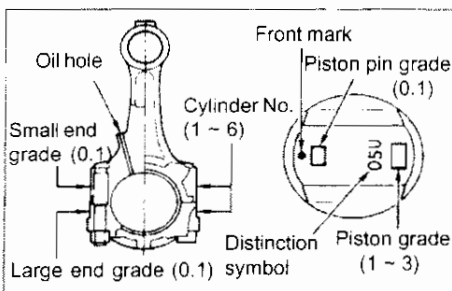

**Con'rod bearing**

(4) Con'rod bearing selection

Connecting rod large end inside diameter		Measurements	Less than 51.007 Greater than 51.000	Less than 51.013 Greater than 51.007
Crank pin diameter	Grade No. stamp		0	1
Less than 47.974 Greater than 47.968	0	Bearing grade No. Bearing thickness (mm) Oil clearance (mm) Identification colour	STD 0 1.500 ~ 1.503 0.020 / 0.039 None	STD 1 1.503 ~ 1.506 0.020 / 0.039 Brown
Less than 47.968 Greater than 47.961	1	Bearing grade No. Bearing thickness (mm) Oil clearance (mm) Identification colour	STD 1 1.503 ~ 1.506 0.020 / 0.040 Brown	STD 2 1.506 ~ 1.509 0.021 / 0.040 Green

Service setting parts: US 0.08, US 0.12, US 0.25

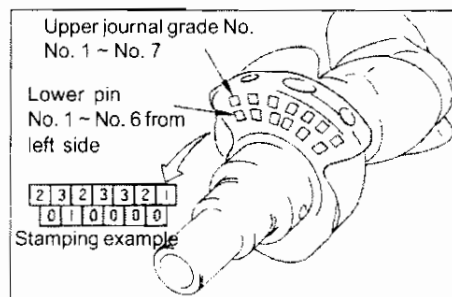

**Disassembly**

- Remove engine from the vehicle body with transmission.
- Disassemble transmission and engine.
- Remove exhaust manifold. For detailed information refer to section on exhaust manifold.
- Install engine sub-attachment using 4 bolts on left side of engine.

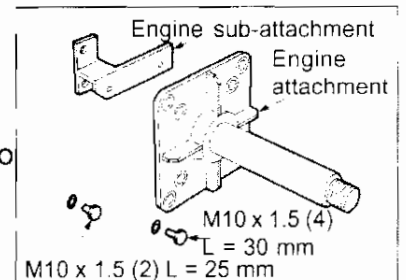

- Engine stand ASSY** ST0501 S000
- Engine attachment** KV101 06500
- Engine sub-attachment** KV101 10700

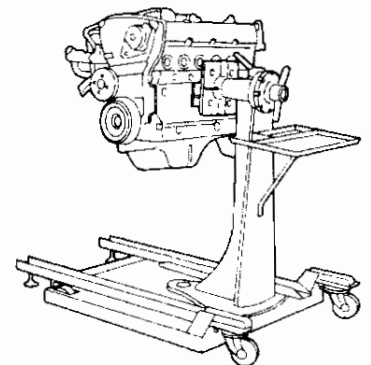

- Drain engine oil and cooling water completely.

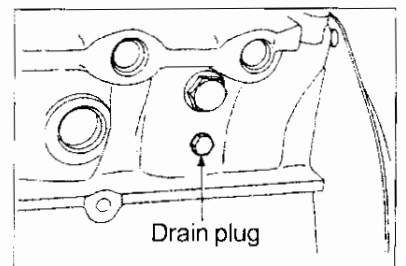

## RB25DE ENGINE

- Remove the following in the order shown:
  - Intake manifold
  - Oil filter and oil filter bracket
  - Timing belt
  - Cylinder head
  - Oil pan
  - Water pump

**Remove flywheel (Drive plate) bolt**

- Insert stick etc. in the gap between cylinder block and the crankshaft to secure flywheel and remove bolts.

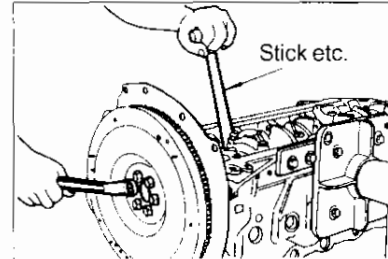
**Remove Pilot bush**

- Use pilot bearing puller to remove pilot bush.

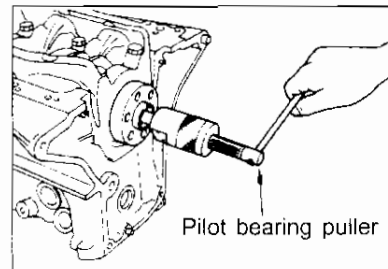
**Remove rear oil retainer**

- Use screwdriver to pry the bearing cap open.

Caution:

Care must be taken not to damage rear oil seal retainer.

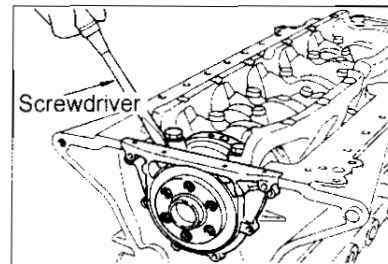
**Remove piston con'rod ASSY**

- Position the piston con'rod to BDC (bottom dead center) position.
- Use a hammer handle or similar tools to press unit to cylinder head side.

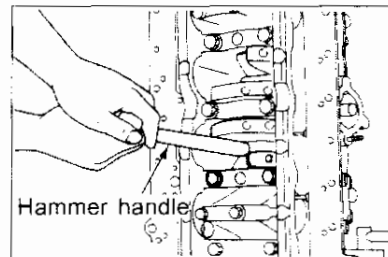

- Disassemble piston con'rod ASSY.
- Use piston ring expander to remove piston ring.

Caution:

Care must be taken not to damage piston.

Do not over expand the piston ring.

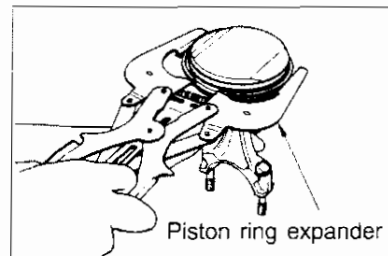

- Use snap ring pliers to remove snap ring.

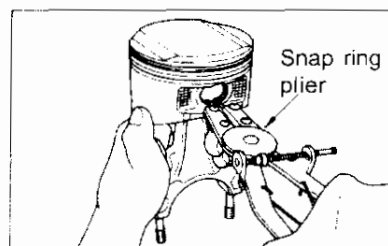



## RB25DE ENGINE

- Remove piston.
- Use a heat gun to heat piston to 60°C ~ 70°C.

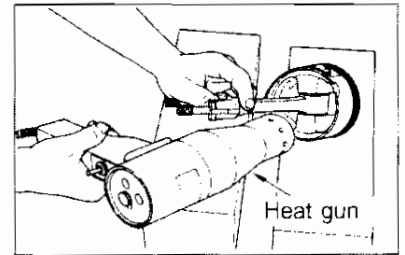

- Place suitable tool against piston pin and use press or plastic hammer to tap lightly.

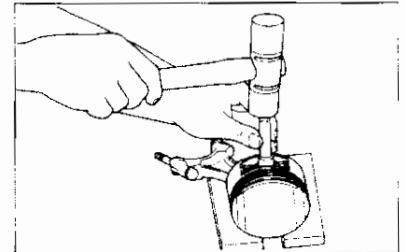

- Remove main bearing cap.
- Remove bearing cap bolts in the sequence shown in the figure on right.

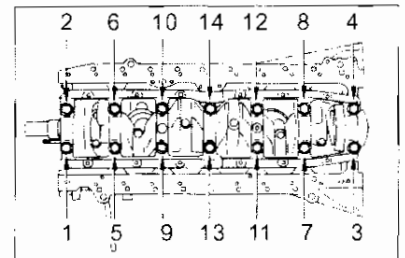

- Use screwdriver to pry the bearing caps open.
- Care must be taken not to damage oil pan rail surface.
- Remove crankshaft.
- Remove main bearing cap and main bearing from cylinder block.

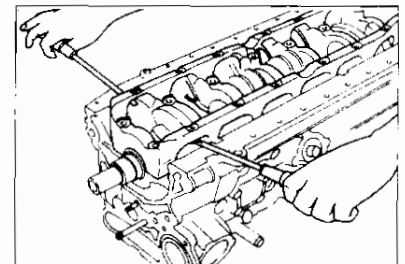
**Inspection****Crankshaft side clearance inspection**

- Use thickness gauge or dial gauge to measure the clearance between crank arm and the thrust bearing (No. 4 bearing) when moving the crankshaft toward front and rear of engine.

**Standard (mm):** 0.05 ~ 0.18

**Limit (mm):** 0.3

- If the clearance is over the limit value replace No. 4 main bearing.

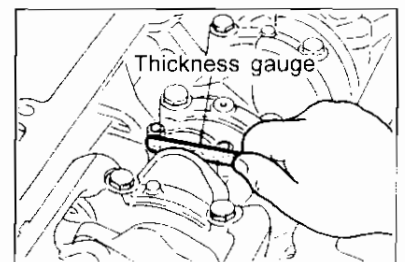
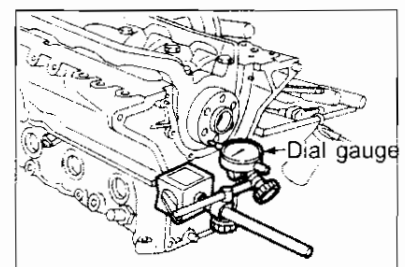

**Con'rod side clearance**

- Check that the crankshaft side clearance is within standard value.
- Use thickness gauge to measure the side clearance between con'rod and the crank arm.

**Standard (mm):** 0.2 ~ 0.3  
**Limit (mm):** 0.4

- If the clearance is over the limit value replace con'rod.

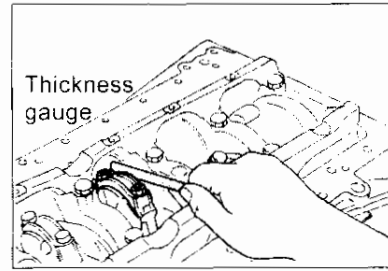

**Piston and piston pin clearance**

- Use inside micrometer to measure piston pin hole diameter.

**Piston pin inside diameter standard value (mm):**  
 20.987 ~ 20.999

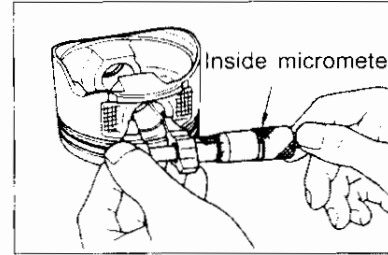

- Use micrometer to measure piston pin exterior diameter.

**Piston pin exterior diameter standard value (mm):**  
 20.989 ~ 21.001

- Work out the piston pin clearance.

Piston pin clearance = Piston pin hole diameter -  
 Piston pin exterior diameter (at 20°C)

**Standard value (mm):** -0.004 ~ 0

- Replace piston and piston pin if the piston clearance exceeds the standard value.

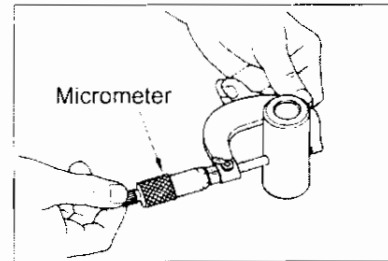

**Piston ring side clearance**

- Measure the clearance between piston ring and piston ring groove.

**Side clearance standard value (mm):**

**Top ring:** 0.040 ~ 0.073  
**Second ring:** 0.030 ~ 0.063  
**Oil ring:** 0.20 ~ 0.76

- Replace piston pin and piston pin ring if the piston ring side clearance exceeds the standard value.

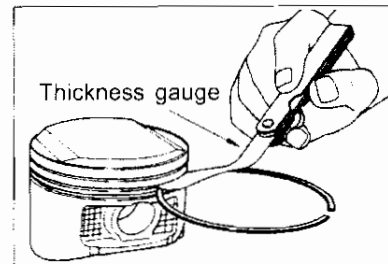

**Ring end gap inspection**

- Using a piston, press the piston ring into the middle of the cylinder and measure the gap.

**Ring end gap standard value (mm):**

**Top ring:** 0.24 ~ 0.44  
**Second ring:** 0.42 ~ 0.67  
**Oil ring:** 0.20 ~ 0.76

- If the ring end gap measurement exceeds the standard value with new piston ring, use oversize piston pin and piston pin ring.

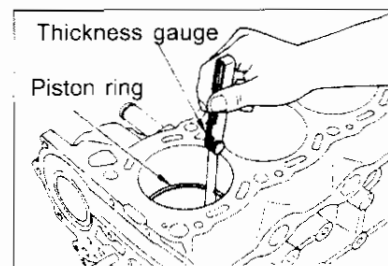

**Con'rod inspection**

**Bend and torsion inspection**

- Use con'rod aligner to measure the bend and torsion.
  - Bend limit (mm): 0.1 to every 100 mm**
  - Torsion limit (mm): 0.3 to every 100 mm**

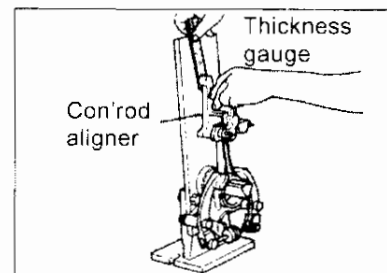

**Con'rod bush oil clearance (small end)**

- Use inside micrometer to measure small end inside diameter.

**Inside diameter standard value (mm):**

- Grade 1: 21.006 ~ 21.000**
- Grade 0: 21.006 ~ 21.012**

- Work out the con'rod bush oil clearance (small end).
  - Oil clearance = Con'rod small end inside diameter - piston pin exterior diameter**

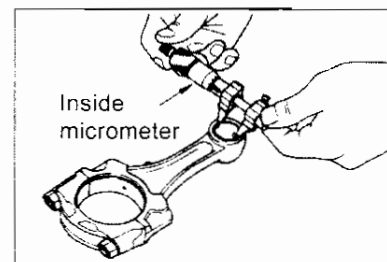

**Oil clearance standard value (mm): 0.005 ~ 0.017**

- Check that the con'rod small end hole grade No. and the piston pin grade No. when fitted.

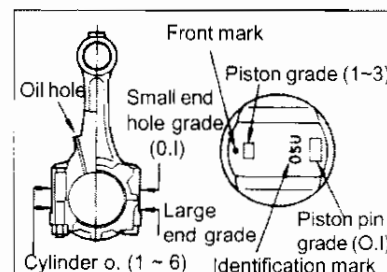

**Cylinder block upper surface distortion inspection**

- Clean upper surface of cylinder block and remove any oil, gasket, sealing substances, carbon ect.
- Measure distortion in six directions using straight gauge and thickness gauge.

**Limit (mm): 0.1**

- If the distortion exceeds the specified limit, resurface the face with surface grinder.

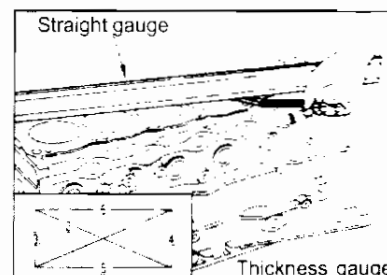

**Piston pin and cylinder bore clearance**

- Check the cylinder bore for any damage and burns.
- Use bore gauge and measure cylinder bore for wear, out-of-round and taper. Measure in three vertical locations (A, B, C) and two directions (X, Y) for a total of six locations.

<b>Cylinder inside diameter standard (mm)</b>	86.000 ~ 86.030
<b>Wear limit (mm)</b>	0.2
<b>Out-of-round limit (mm)</b>	0.015
<b>Taper limit (mm)</b>	0.010

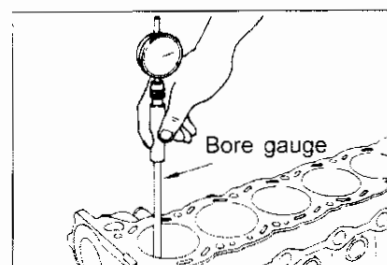

- Out-of-round measurement is difference of measurement in two directions (X, Y).
- Taper is difference of measurement at top and bottom (A, C).

RB25DE ENGINE

- Perform honing and boring when abnormality if inspected.

**Caution:**

Make sure to check the bore grade No. and the piston grade No. when replacing the cylinder block or piston.

- Use micrometer to measure outside piston skirt diameter.
- To prevent cylinder bore distortion, fix main bearing cap and tighten to specified tightening torque.

**Specified position (mm): 18 from piston lower part**  
**Standard (mm): 85.955 ~ 85.985**

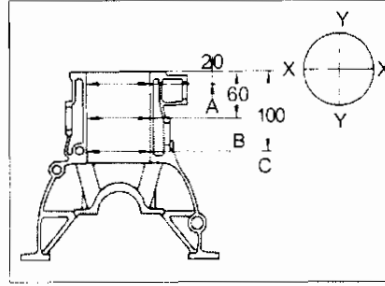

**Piston and bore clearance =**  
**Bore diameter (X, Y direction) -**  
**Piston pin exterior diameter**

- Five types of pistons are available for service.

Grades	Exterior diameter
Grade 1	85.975 ~ 85.985 (mm)
Grade 2	85.985 ~ 85.995
Grade 3	85.995 ~ 86.005
OS 0.5	86.745 ~ 86.775
OS 1.0	86.975 ~ 87.005

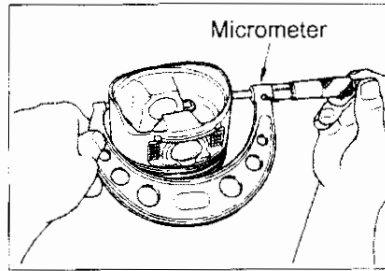

**Crankshaft inspection**

- Check for any wear and cracks on crankshaft journal and pin .
- Use micrometer to check each journal and each pin exterior diameter.

**Journal standard diameter (mm): 47.961 ~ 47.974**

**Pin standard diameter (mm): 54.951 ~ 54.975**

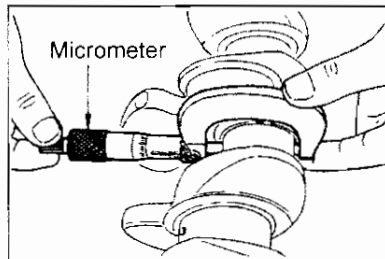

- Use micrometer to check each journal (No. 1 ~ 7) and each pin (No. 1 ~ 6) in four locations shown in the figure on right.
- The out-of-round value is the difference of the dimensions in directions A and B.
- The taper value is the difference of the dimensions measured at points 1 and 2.

**Out-of-round limit value A - B (mm): 0.005**

**Taper limit value 1 - 2 (mm): 0.005**

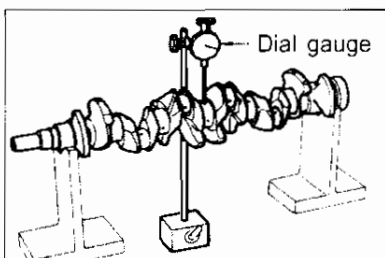
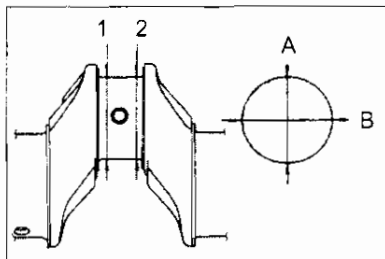

**Main bearing oil clearance inspection****Using micrometer and bore gauge (Method A)**

- Fit main bearing to cylinder block and main bearing cap. Tighten to specified tightening torque.
- Use bore gauge to measure each main bearing inside diameter.

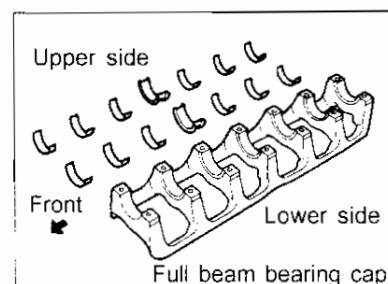

**Oil clearance = Main bearing inside diameter -  
Journal exterior diameter**

**Standard (mm): 0.020 ~ 0.047**

**Limit (mm): 0.090**

- Select main bearing with proper thickness according to the following table if the value is over the limit value.

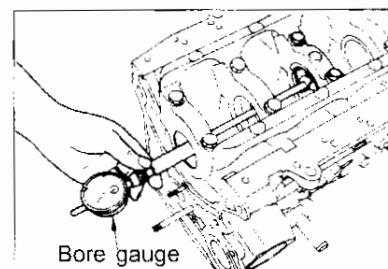
**Main bearing selection chart**

Crank pin diameter		Grade No. stamp		Less than 58.654 Greater than 58.645	Less than 58.663 Greater than 58.654	Less than 58.672 Greater than 58.663
Less than	Greater than			0	1	2
Less than 54.975 Greater than 54.967		0	Bearing grade No. Bearing thickness (mm) Oil clearance (mm) Identification colour	STD 0 1.825 / 1.821 0.020 / 0.045 Black	STD 1 1.829 / 1.825 0.021 / 0.046 Brown	STD 2 1.833 / 1.829 0.020 / 0.047 None
Less than 54.967 Greater than 54.959		1	Bearing grade No. Bearing thickness (mm) Oil clearance (mm) Identification colour	STD 1 1.829 / 1.825 0.020 / 0.045 Brown	STD 2 1.833 / 1.829 0.021 / 0.046 None	STD 3 1.837 / 1.833 0.022 / 0.047 Yellow
Less than 54.959 Greater than 54.951		2	Bearing grade No. Bearing thickness (mm) Oil clearance (mm) Identification colour	STD 2 1.833 ~ 1.829 0.020 / 0.045 None	STD 3 1.837 / 1.833 0.021 / 0.046 Yellow	STD 4 1.841 / 1.837 0.022 / 0.047 Blue

**Caution:**

No. 1 ~ No. 3, No. 5 ~ No. 7 Upper side (with groove, width 19 mm)

No. 1 ~ No. 3, No. 5 ~ No. 7 Lower side (without groove, width 19 mm)

No. 4 Upper side (with thrust metal, with groove, width 26.9 mm)

No. 4 Lower side (with thrust metal, without groove, width 26.9 mm)

- Use undersize main bearing if the oil clearance can not be adjusted using the standard main bearing.

**Undersize main bearing**

Size	Thickness (mm)
US0.25	1.950 / 1.958

- Grind the crankshaft journal if the oil clearance value is still not within the standard value using the undersize bearing.

**Caution:**

Retain fillet R when grinding the crankshaft journal.

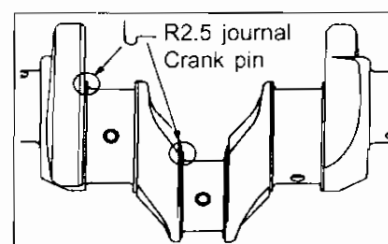

- Cylinder block housing grade is imprinted on the oil pan aligning side.

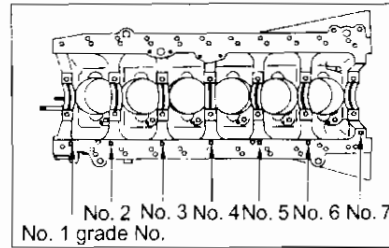

- When replacing main bearing, check the bearing grade (indicated on bottom surface of cylinder block) and journal diameter grade (indicated on crankshaft No. 1 counter weight front surface). Select main bearing with proper thickness according to the selection table.

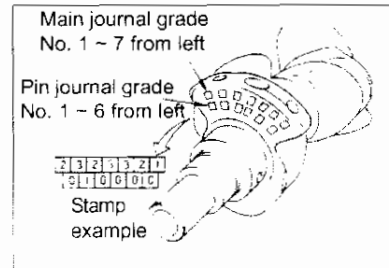

**Con'rod bearing oil clearance**

- Install con'rod bearing to con'rod and con'rod cap.
- Align con'rod oil hole and bearing oil hole and install.

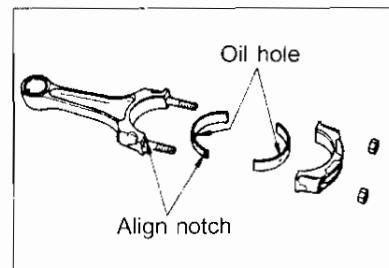

- Use inside micrometer to measure con'rod bearing inside diameter.

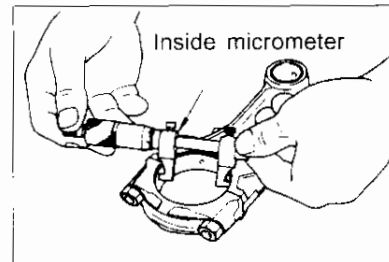

**Con'rod oil clearance =**

**Con'rod bearing inside diameter - Pin exterior diameter**  
**Standard value (mm): 0.020 ~ 0.040**

- Select correct main bearing from below chart if the con'rod oil clearance is not within the standard value.

Con'rod large end inside diameter		Less than 51.007 Greater than 51.000		Less than 51.013 Greater than 51.007	
Crank pin diameter	Grade No. stamp	0		1	
Less than 47.974 Greater than 47.968	0	Bearing grade No. Bearing thickness (mm) Oil clearance (mm) Identification colour	STD 0 1.500 ~ 1.503 0.020 / 0.039 None	Bearing grade No. Bearing thickness (mm) Oil clearance (mm) Identification colour	STD 1 1.503 ~ 1.506 0.020 / 0.039 Brown
Less than 47.968 Greater than 47.961	1	Bearing grade No. Bearing thickness (mm) Oil clearance (mm) Identification colour	STD 1 1.503 ~ 1.506 0.020 / 0.040 Brown	Bearing grade No. Bearing thickness (mm) Oil clearance (mm) Identification colour	STD 2 1.506 ~ 1.509 0.021 / 0.040 Green

- Use undersize con'rod bearing if the oil clearance can not be adjusted using standard con'rod bearing.

Size	Thickness (mm)	Grade No.
US 0.08	1.541 / 1.549	8
US 0.12	1.561 / 1.569	12
US 0.25	1.626 / 1.634	25

## RB25DE ENGINE

- Grind the crank pin if the oil clearance value is still not within the standard value using the undersize bearing.
- Select correct main bearing using the chart if crankshaft con'rod is new.
- Con'rod large end grade is printed on large end surface.

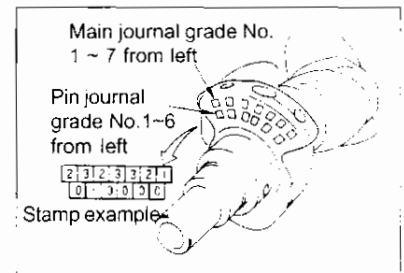
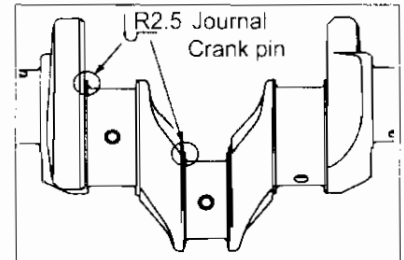
**Using plastigauge (Method B)**

- Remove all dust from crankshaft pin and bearing surfaces.
- Cut off a piece of plastigauge slightly shorter than the gearing width. Place the plastigauge on crankshaft in direction of axis, care must be taken not to place on oil hole.
- Assemble con'rod bearing in con'rod cap and tighten connecting rod nuts to specified torque.

**Caution:**

Do not turn crankshaft while plastigauge is being inserted.

- Remove cap and bearing and measure plastigauge width with plastigauge scale.
- Standard value and bearing selection is same as method A.

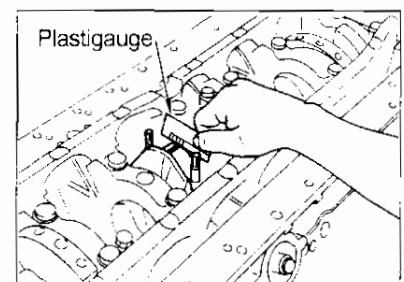
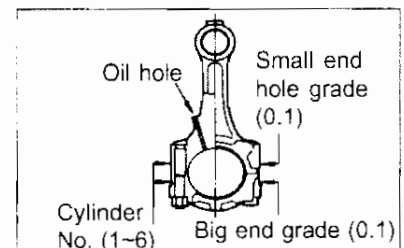
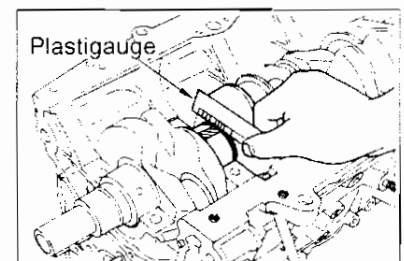

**Piston and con'rod installation**

- Use snap ring plier to install snap ring to installation groove on the piston.
- Always replace snap ring with new ones.

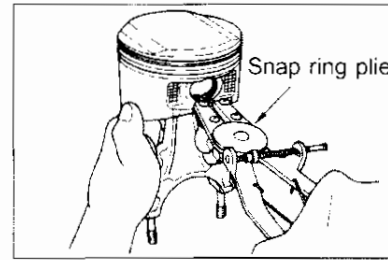

- Position piston front mark so the con'rod oil hole faces right side of engine (left side when viewed from front).

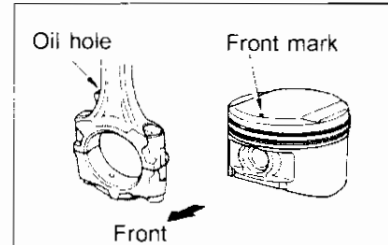

- Use a heat gun to heat piston to 60°C ~ 70°C.
- Apply plenty of oil to pin, pin hole, con'rod small hole.
- Press-fit piston pin into piston pin con'rod from the front of piston to the rear side of piston.
- Install snap ring on piston front side. After the installation make sure the con'rod move smoothly.

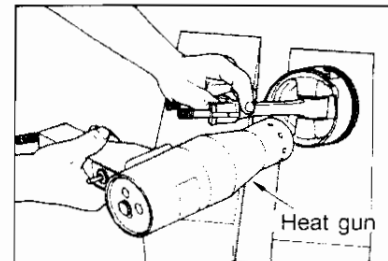

- Use piston pin expander to install piston rings in correct position.

Caution:

- Care must be taken not to damage or scratch piston.

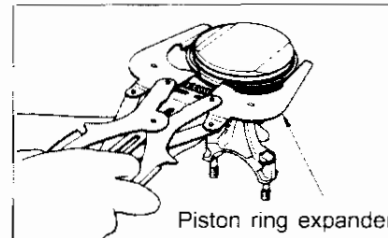

- The stamped marks on top and second piston ring openings must face up.

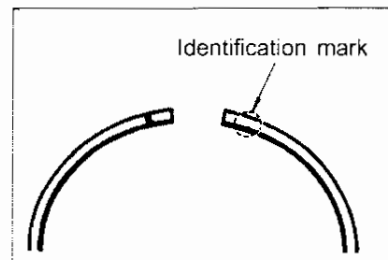

**Install crankshaft**

- Install main bearing to cylinder block and main bearing cap.
- Apply plenty of engine oil on the inside surface of the bearings.
- Align the bearing notch and the block cap notch to install.
- Place crankshaft on cylinder block and tighten main bearing cap bolts in several stages.

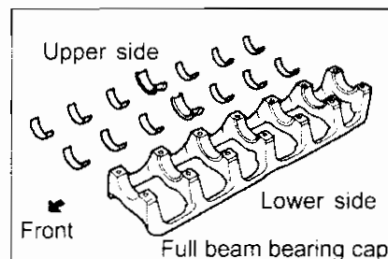

**Tightening torque (kg-m): 4.7 ~ 5.3**

- Apply engine oil to threaded part and flange.
- After tightening to the specified torque, check that crank shaft turns smoothly.

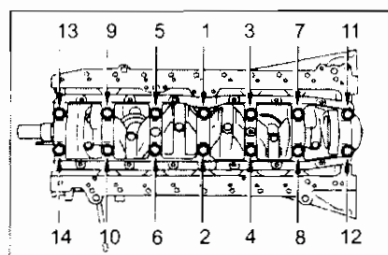



**Piston & con'rod installation**

- Install con'rod bearing to con'rod and con'rod cap.
- Apply engine oil to con'rod bearing exterior surface. Do not apply engine oil to interior surface, instead clean sufficiently.
- Make sure the con'rod main body oil hole and the bearing oil hole is aligned correctly.

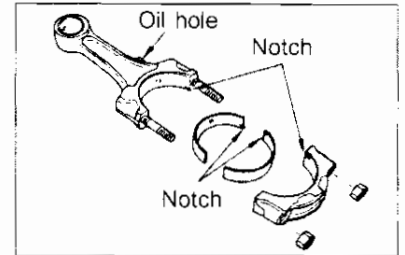

- When installing con'rod bolt make sure the bolt head with larger chamfer of thread is on con'rod side.

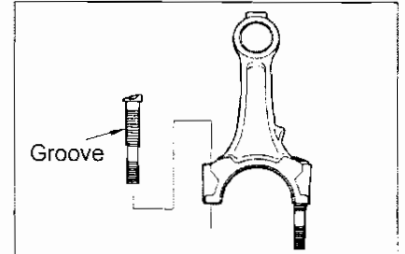

- Install piston and con'rod ASSY to crankshaft.
- Position the crank pin to BDC (bottom dead centre).
- Coat cylinder bore, piston and crank pin with engine oil.
- Position the piston ring openings as shown in the figure on right.

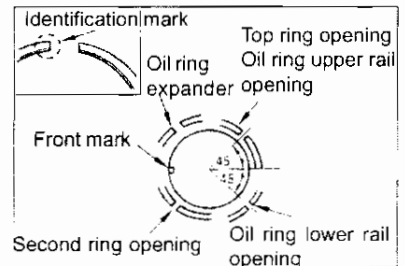

- Check the cylinder position and con'rod cylinder No.

- Position piston front mark to engine front and use piston ring compressor to install piston.

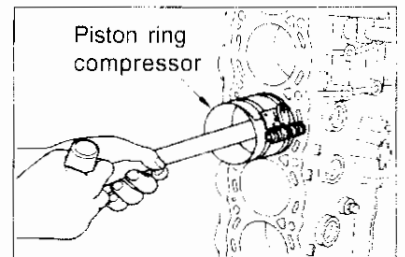

**Caution:**

Care must be taken not to damage crankshaft and cylinder inner wall by supporting con'rod big end.

- Tighten con'rod nuts in the following procedures.
- Apply engine oil to con'rod bolts and nuts flange.
- Tighten the bolts and nuts.

**Torque wrench (kg-m):** 1.4 ~ 1.6

**Angle wrench (o):** 60° ~ 65°

- After installing all con'rod ASSY, rotate the crankshaft and make sure it rotates smoothly.

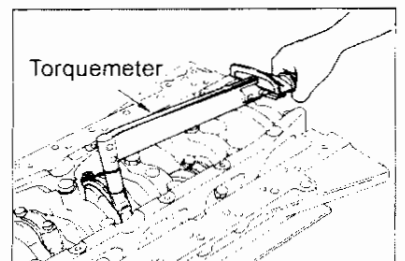

- Check the con'rod side clearance.
- Check the crankshaft thrust clearance.

**Pilot bushing replacement**

- Use a pilot bearing puller to remove pilot bushing.

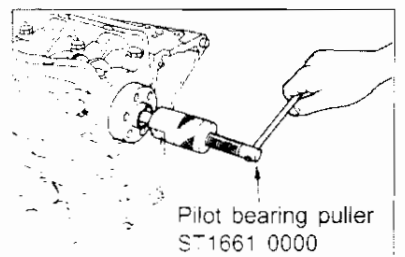

Pilot bearing puller  
S1661 0000

RB25DE ENGINE

- The pilot bushing installation position is shown in the figure on right.

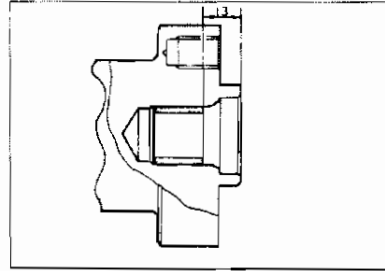

**Fly-wheel installation (M / T vehicle)**

- Coat bolts thread and flange with engine oil.
- After tightening the flywheel installation bolts halfway, use the ring gear stopper to secure fly-wheel and tighten bolts.
- Tighten bolts in several stages.

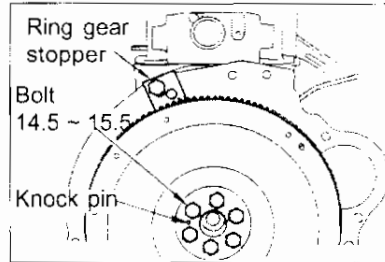

**Fly-wheel knock pin insertion**

- Insert the fly-wheel knock pin so the pin protrudes 8 to 8.5 mm.

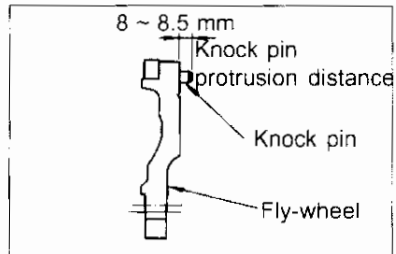

**Reinforcement plate installation (A / T vehicle)**

- Take care with installation direction when installing reinforcement plate for A / T vehicles.

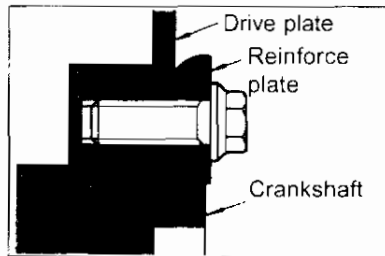

**Fly-wheel runout**

- Set dial gauge to fly-wheel where it contacts clutch.
- Turn the fly-wheel and measure the runout.

**Runout limit (mm)                      0.10**

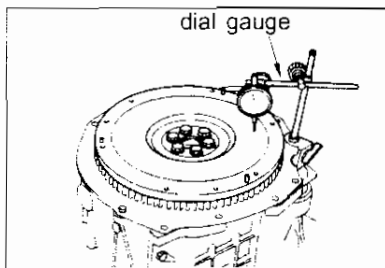

## 12 ENGINE OVERHAUL

This section describes the component disassembly of the engine assembly removed from the vehicle without transmission. It also explains the inspection, replacement of malfunctioning, damages or worn parts and carry out any necessary adjustments and sequential assembly in order to produce a standard engine condition.

### OVERHAUL CAUTIONS

#### (1) Disassembly

- Use correct and suitable tools when possible and make sure to carry out safe procedures.
- Care must be taken with operations on mating surfaces and sliding surfaces to prevent loss of surface accuracy.
- Arrange disassembled parts by making marks to organize for easy faults detection and precise assembly.
- Loosen nuts and bolts in a diagonal direction from outside. Care must be taken to follow the numerical order when indicated.

#### (2) Inspection, repair and replacement

- Replace or repair after completing parts inspection following the inspection procedures. Perform same inspection for the new parts and replace parts as necessary.

#### (3) Assembly

- Always use a torque wrench to tighten nuts and bolts to specific tightening torque.
- Tighten nuts and bolts from centre to outside diagonal direction, gradually in two or three successive stages. Follow the numeric order when indicated.
- Replace gasket, packing, oil seals and O-rings with new ones in principle.
- Clean each part thoroughly and blown off with compressed air. In particular, check that oil and water passages are not clogged or obstructed.
- Care must be taken not to scratch or damage sliding or mating surfaces. Clean off all dust, debris or foreign objects. Lubricate all sliding surface with an adequate coating oil.

## 12-1 DISASSEMBLE &amp; ASSEMBLE CYLINDER BLOCK ASSY

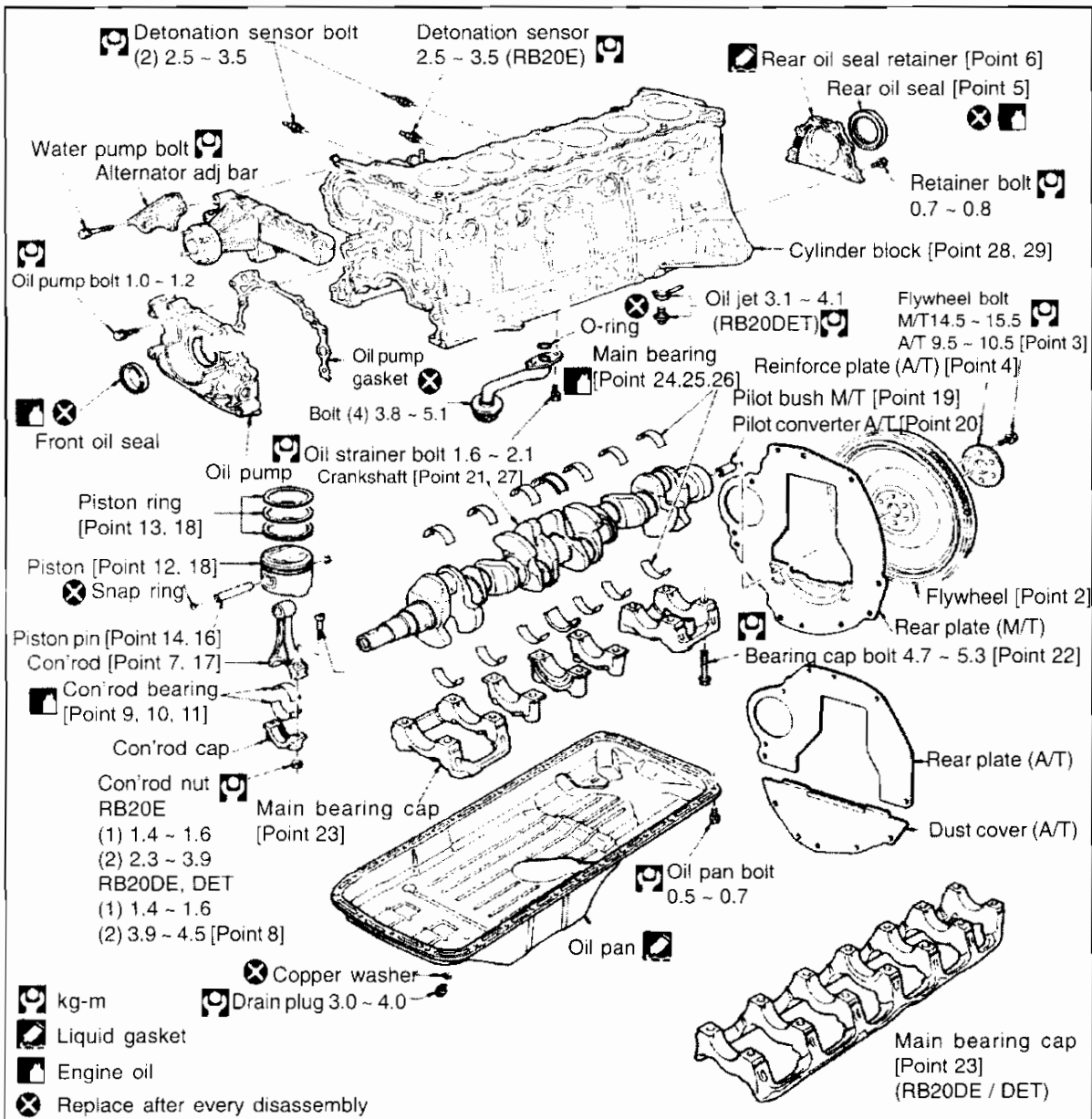
**Additional work required:**

- Remove and install the following parts:
  - Engine
  - Exhaust manifold ASSY
  - Turbocharger (RB20DET)
  - Collector ESSY (RB20E)
  - Intake manifold ASSY
  - Timing belt
  - Rocker cover, cylinderhead ASSY
  - Alternator
  - Water pump

**[Point 1] Remove & install engine stand**

- Install the engine sub attachment using 4 bolts on left side of the engine.

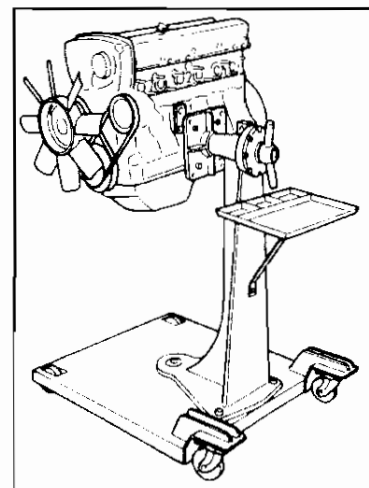
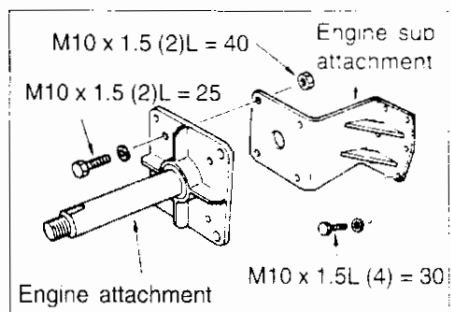
**[Point 2] Flywheel run-out**

- Set dial gauge to flywheel where it contacts clutch.
- Turn the flywheel and measure the run-out.

**Run-out limit (mm): 0.10**

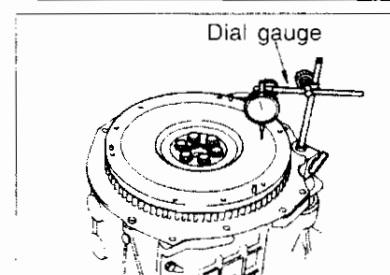
**[Point 3] Remove & install flywheel (drive plate) bolts**  
**Removal**

- Insert a stopper between cylinder block and the crank shaft to stop crankshaft from moving.

**Installation**

- Coat the thread and flange of bolts with engine oil when installing the bolts.

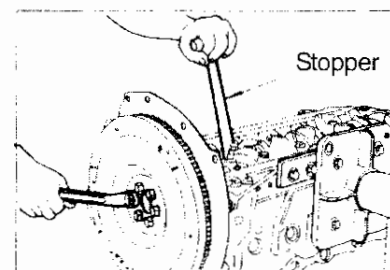
**[Point 4] Reinforcement plate installation (A/T vehicle)**

- Take care with installation direction when installing reinforcement plate for A/T vehicles.

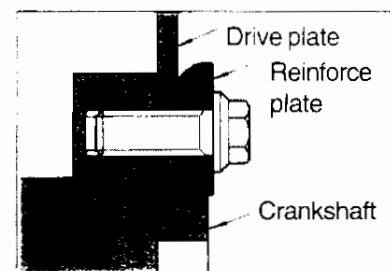
**[Point 5] Remove & install rear oil seal****Removal**

- Use tool such as screwdriver to remove seal.

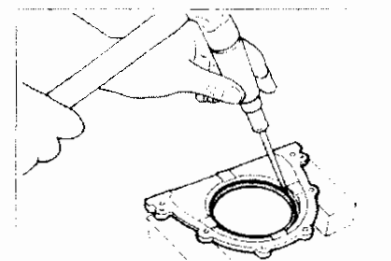
**Installation**

- Care must be taken not to scratch or damage the oil seal perimeter area. Use oil seal drift (outside diameter: 110mm) to install new oil seal.
- Apply a coat of engine oil or chassis grease to oil seal lip area.

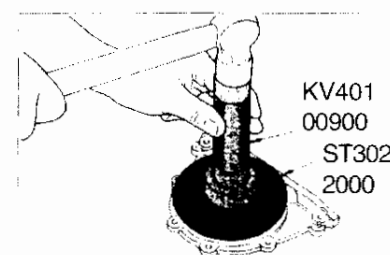

**[Point 6] Remove & install rear oil seal retainer****Removal**

- Insert a screwdriver in the gap between main bearing cap and rear oil seal retainer to remove seal.

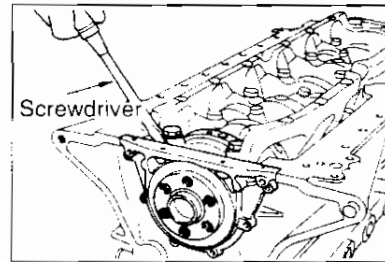
**Cleaning**

- Use scraper to remove liquid gasket.
- Clean the cylinder block side in the same way.
- Wipe mating surface with white gasoline.

**Caution:**

Also remove liquid gasket in the grooves.

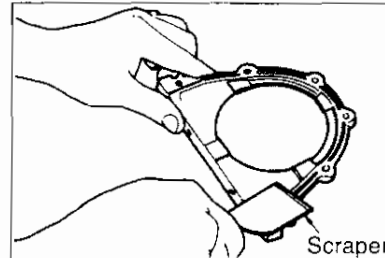
**Installation**

- Apply liquid gasket and install unit within 5 minutes.
- Cut nozzle end of the liquid gasket (KP510 00150) tube as shown in the figure on right. Use tube presser for application.

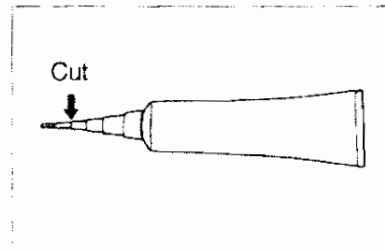

- Apply liquid gasket continuously to rear oil seal retainer.

**Caution:**

Make sure liquid gasket width is 2.0 ~ 3.0 mm.

Refill engine oil and start the engine 30 minutes after assembly is completed.

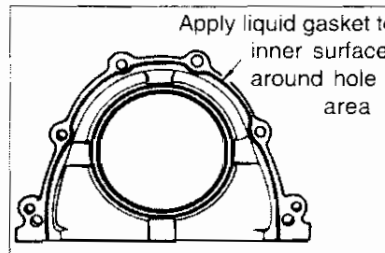
**[Point 7] Con'rod side clearance inspection**

- Use thickness gauge to measure the thrust clearance between the con'rod and the crank arm.

**Standard value (mm):** 0.2 ~ 0.3

**Limit value (mm):** 0.4

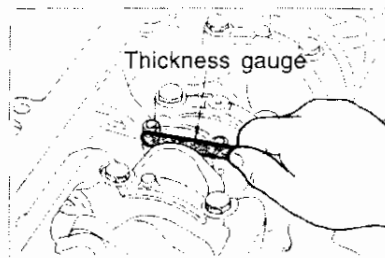
**[Point 8] Con'rod nut tightening**

- Tighten nuts in two stages.

**(RB20E)**

**1st time Torque wrench (kg-m):** 1.4 ~ 1.6

**2nd time Torque wrench (kg-m):** 1.4 ~ 1.6

**(RB20DE / DET)**

**1st time Torque wrench (kg-m):** 2.3 ~ 2.9

**2nd time Torque wrench (kg-m):** 3.9 ~ 4.5

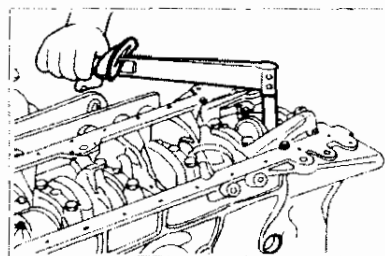

**[Point 9] Install con'rod bearing**

- Coat engine oil to bearing surface when installing con'rod bearing. Do not apply engine oil to rear surface of the bearing, clean this area.
- Align con'rod bearing retainer notches and install (left side).
- Make sure the con'rod body oil hole and the bearing oil hole is aligned.

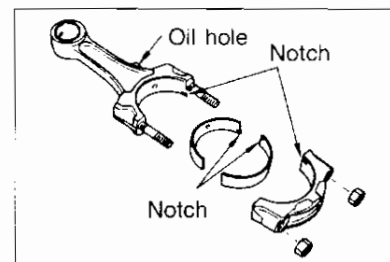
**[Point 10] Con'rod bearing oil clearance inspection****(A) Measuring basis**

- Install con'rod bearing to con'rod and con'rod cap then tighten the con'rod nuts to specified torque. Measure con'rod bearing inside diameter.
- Oil clearance can be calculated using the crank pin outer die measured using points in [Point 27].

**(Oil clearance) =**

**(Bearing inside diameter) - (Crank pin outer die)**

**Standard value (mm): 0.011 ~ 0.035**

**Limit value (mm): 0.090**

- Select the bearing using [Point 11] as a reference if the oil clearance is over the limit value.

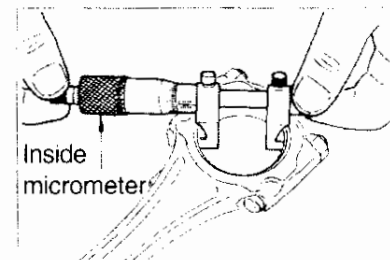
**(B) Using plastigauge**

- Remove any dust from crankshaft pin and bearing surfaces.
- Cut off a piece of plastigauge slightly shorter than the bearing width. Place the plastigauge on the crankshaft in direction of axis. Care must be taken not to place it on the oil hole.
- Assemble connecting rod bearing in connecting rod cap and tighten connecting rod nuts to specified torque.
- Remove con'rod cap and bearing and measure plastigauge width with a plastigauge scale.

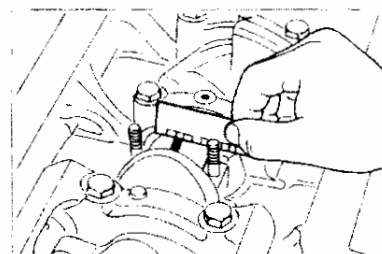
**Caution:**

Never turn the crankshaft or connecting rod while plastigauge is being inserted.

**[Point 11] Con'rod bearing selection**

- Select the correct sized bearing as the con'rod bearing prevents fluctuation in the oil clearance. Three bearing thicknesses are available depending on inside diameter of the big end of the con'rod and the crank pin diameter.
- When replacing the con'rod bearing, check big end inside diameter gauge (indicated on the opposite side of the con'rod hole) and the pin diameter grade (indicated on crankshaft No. 1 counterweight front surface).

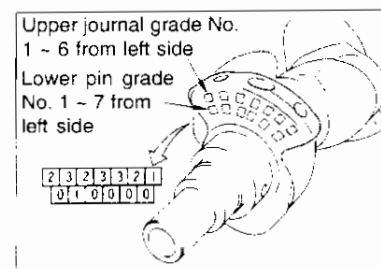
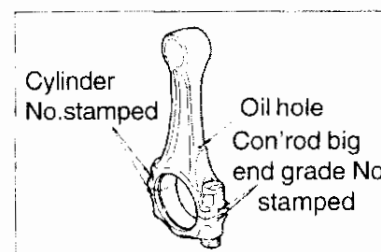

## Con'rod bearing selection chart RB20E

Con'rod large end inside diameter		Less than 48.007 Greater than 48.000		Less than 48.013 Greater than 48.007	
Crank pin diameter	Grade No. stamp	0		1	
Less than 44.974 Greater than 44.968	0	Bearing grade No. Bearing thickness (mm) Oil clearance (mm) Identification colour	STD 0 1.506 / 1.502 0.014 / 0.035 None	Bearing grade No. Bearing thickness (mm) Oil clearance (mm) Identification colour	STD 1 1.510 / 1.506 1.014 / 0.035 Brown
Less than 44.968 Greater than 44.961	1	Bearing grade No. Bearing thickness (mm) Oil clearance (mm) Identification colour	STD 1 1.510 / 1.506 0.012 / 0.034 Brown	Bearing grade No. Bearing thickness (mm) Oil clearance (mm) Identification colour	STD 2 1.514 / 1.510 0.011 / 0.032 Green

Bearing used (Width 16mm)

## RB20DE / DET

Con'rod large end inside diameter		Less than 48.007 Greater than 48.000		Less than 48.013 Greater than 48.007	
Crank pin diameter	Grade No. stamp	0		1	
Less than 44.974 Greater than 44.968	0	Bearing grade No. Bearing thickness (mm) Oil clearance (mm) Identification colour	STD 0 1.506 / 1.502 0.014 / 0.035 None	Bearing grade No. Bearing thickness (mm) Oil clearance (mm) Identification colour	STD 1 1.510 / 1.506 1.014 / 0.035 Brown
Less than 44.968 Greater than 44.961	1	Bearing grade No. Bearing thickness (mm) Oil clearance (mm) Identification colour	STD 1 1.510 / 1.506 0.012 / 0.034 Brown	Bearing grade No. Bearing thickness (mm) Oil clearance (mm) Identification colour	STD 2 1.514 / 1.510 0.011 / 0.032 Green

- When using undersize bearings, measure bearing inside diameter when bearing is installed. Grind pin so oil clearance conforms to specific value.

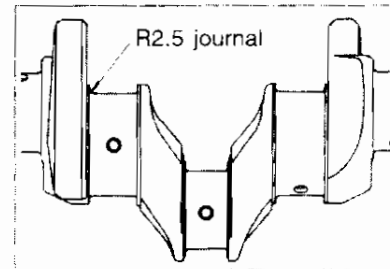

## Bearing undersize chart

Size	Thickness (mm)	Grade No.
US0.08	1.548 / 1.540	8
US0.12	1.568 / 1.560	12
US0.25	1.633 / 1.625	25

### Caution:

Care must be taken not to scratch fillet roll when the crank pin is being grounded to use undersize bearing.

## [Point 12] Piston pin con'rod ASSY Removal

- Use tools such as end of hammer and push it towards the cylinderhead side.

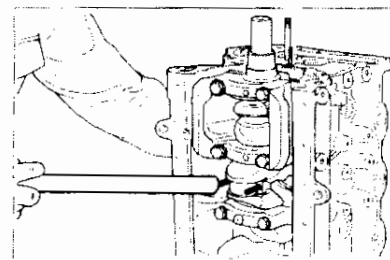



**Removal**

- Set the crank pin at B.D.C (bottom dead center) position.
- Coat engine oil to cylinder bore, crank pin and piston.
- Use piston ring compressor to install piston pin and con'rod ASSY to the cylinder block.

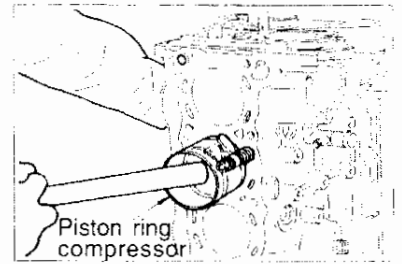

- Make sure to position oil jet correctly when installing it to RB20DET engines so that the oil jet and the piston will not interfere.

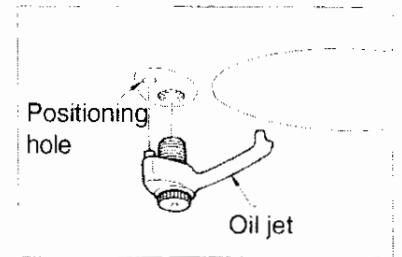

Caution:

Front mark on the piston should face engine front side when installing. Oil hole and baffle notch of con'rod and con'rod cap should be on right hand side of the engine when installing.

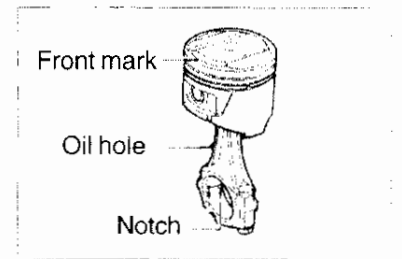

**[Point 12] Remove & install piston ring**  
**Removal**

- Use piston ring expander to remove rings.

Caution:

Care must be taken not to scratch piston.

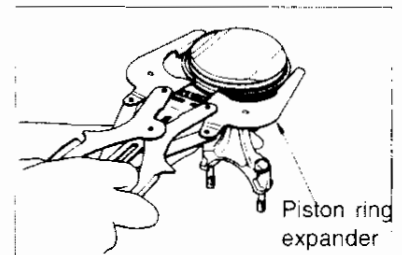

**Installation**

- The stamped marks on top and second piston ring openings must face up.

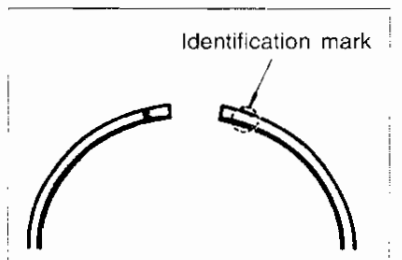

- Position the piston rings as shown in the figure on right to install.

Caution:

Care must be taken not to scratch piston.

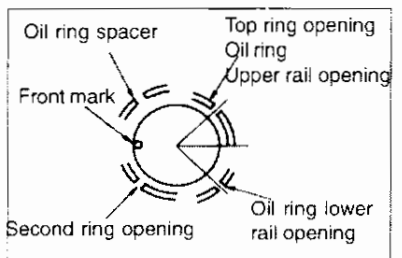

**[Point 14] Remove & install piston pin  
(Engine number RB20 - 030511 in case of RB20E for C32)**

- Connection process for the piston and the con'rod is called press fit method. Piston pin press stand ASSY must be used to remove the piston pin.

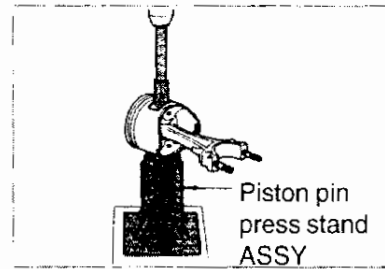

**(RB20DE / DET)**

- Connection process is called full float method. Use a heat gun to heat piston to 60 ~ 70°C when removing and installing piston pin.
- Place suitable tool against piston pin and press or use plastic hammer.

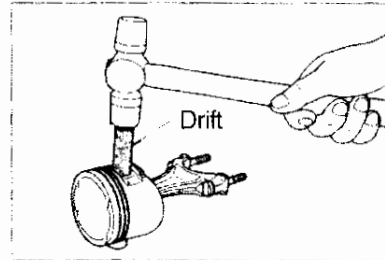

**Piston pin press-fit**

- Place the piston front mark so the con'rod oil hole faces right side of the engine (left side when viewed from front) and press-fit.

**Caution:**

Press-fit the piston pin from the front of piston to the rear side of piston.

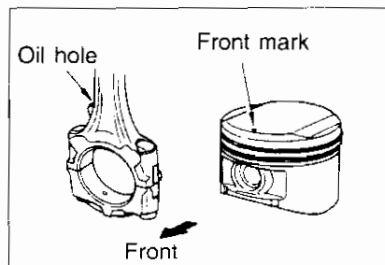

**[Point 15] Piston pin inspection**

- Use the micrometer to measure outside diameter of piston pin skirt.

**Measuring location from skirt bottom :**

(RB20E)	20mm
(RB20DE / DET)	15mm

**Outside diameter standard value (mm)**

(RB20E)	77.915 ~ 77.965
(RB20E / DET)	77.925 ~ 77.975

- Use micrometer to measure piston pin opening diameter.

**Standard value (mm):**

(RB20E)	18.987 ~ 18.999
(RB20DE / DET)	20.987 ~ 20.999

**Press fit type RB20E for C32 18.995 ~ 19.000**

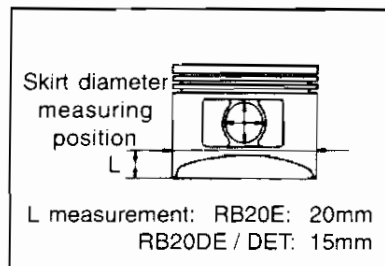
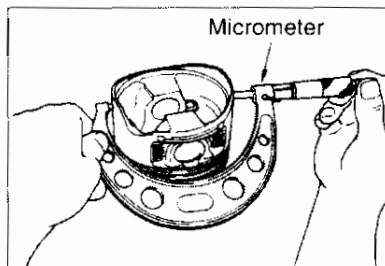

**[Point 16] Piston pin inspection**

- Use micrometer to measure outside diameter of piston pin.

**Standard value (mm):**

(RB20E)	18.989 ~ 19.001
(RB20DE / DET)	20.989 ~ 21.001

**Press fit type RB20E for C32 18.995 ~ 19.000**

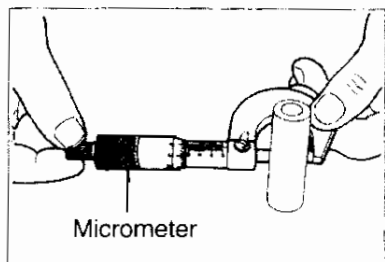

- Piston pin clearance is the figure obtained by subtracting the piston pin outside diameter [Point 15] from the piston pin hole inside diameter [Point 16].

**Piston clearance at normal temperature (20°C):**

**0 ~ -0.004mm**

**Piston clearance at normal temperature (20°) for press fit type RB20 for C32 is between 0.008 ~ 0.010mm**

- Insert the piston pin as shown in the figure on the right and check if it move smoothly.

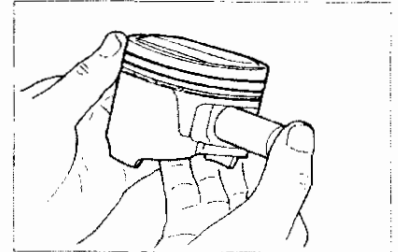

**[Point 17] Con'rod inspection**

**Bend and torsion inspection**

- Use con'rod aligner to measure the bend and torsion.

**Bend limit (1/100 mm): 0.025**

**Torsion limit (1/100 mm): 0.025**

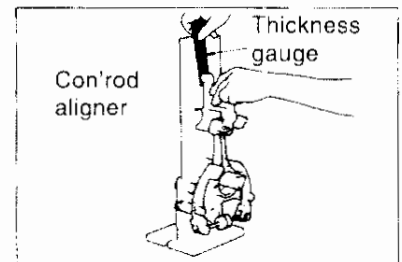

**Small end inside diameter inspection**

**Standard value (mm):**

**(RB20E) 19.000 ~ 19.012**

**(RB20DE / DET) 21.000 ~ 21.012**

**Press fit type RB20E for C32 18.965 ~ 18.978**

**[Point 19] Con'rod small end bushing clearance**

- The difference between the small end inside diameter [Point 17] and piston pin outside diameter [Point 15] is the bushing clearance (full float type).

**Bushing clearance standard value (mm): 0.005 ~ 0.017**

- The con'rod small end and piston pin outside diameter are separated into two grades at the factory. Make sure that the grades (0.1) conform for both parts because the rod and pin are selected and fitted according to bushing clearance.

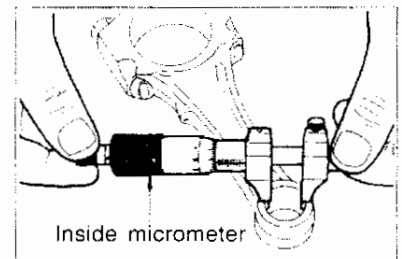

**[Point 18] Piston ring end gap and side clearance gap inspection**

- Use a piston to press the piston ring into the middle of the cylinder and measure the gap.

Type	Standard value (mm)		
	Top ring	Second ring	Oil ring (rail)
RB20E	0.22 ~ 0.45	0.19 ~ 0.45	0.20 ~ 0.76
RB20DE	0.22 ~ 0.45	0.19 ~ 0.45	0.20 ~ 0.76
RB20DET	0.22 ~ 0.39	0.19 ~ 0.45	0.20 ~ 0.76

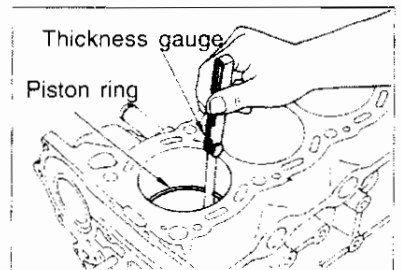

**Side clearance inspection**

- Measure the clearance between the piston ring and the piston ring groove.

	Top ring	Second ring	Oil ring
<b>Standard value (mm)</b>	0.040 ~ 0.073	0.030 ~ 0.063	0.035 ~ 0.140
<b>Limit value (mm)</b>	0.1	0.1	-

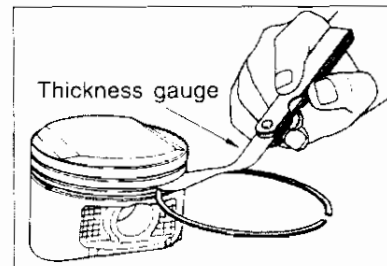

**[Point 19] Remove & install pilot bushing**

**Removal**

- Use a pilot bearing puller to remove pilot bushing.

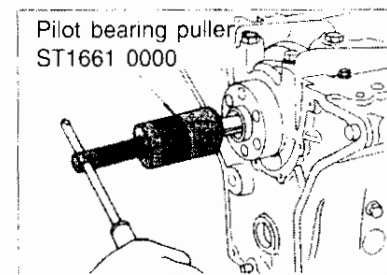

**Installation**

- The pilot bushing installation position is as shown in the figure on right.

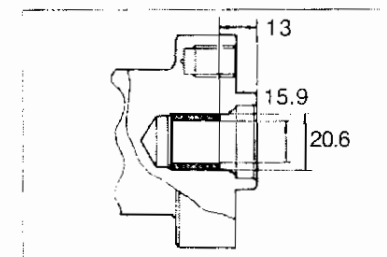

**[Point 20] Remove & install pilot converter (A/T)**

- Make sure to install pilot converter in correct direction.

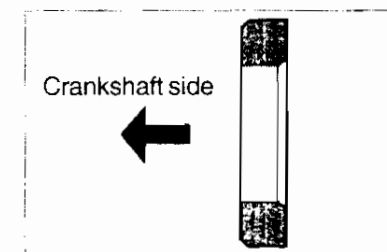

**[Point 21] Crankshaft thrust clearance inspection**

- Use a thickness gauge to measure the clearance between the thrust bearing (No. 4 bearing) and the crank arm when moving the crankshaft forward or backward.

**Standard value (mm):** 0.05 ~ 0.18

**Limit value (mm):** 0.3

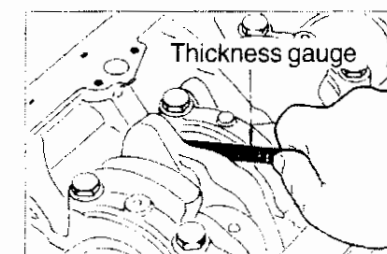

**[Point 22] Remove & install main bearing bolts**

- Remove bearing bolts in the order shown in the figure on right.
- Tighten bolts to specified torque in two to three stages in reverse order shown in the figure. Make sure the crankshaft turns smoothly after tightening the bolts to specified torque.

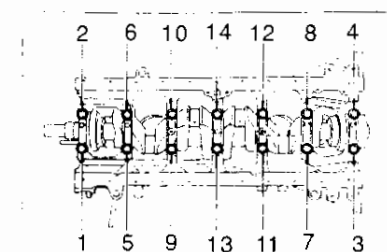

**[Point 23] Remove & install main bearing cap (RB20E)**

- Use main bearing bolt to remove bearing cap by shifting it forward and backward.

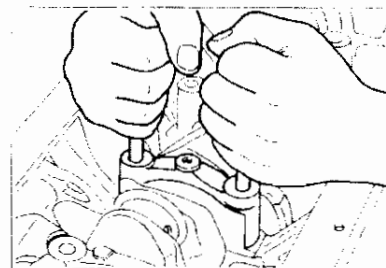

- Main bearing distinction can be checked by marks on each main bearing.
- Make sure to face the arrow mark on the bearing to engine front when installing No. 3, 4 and 5 bearings.

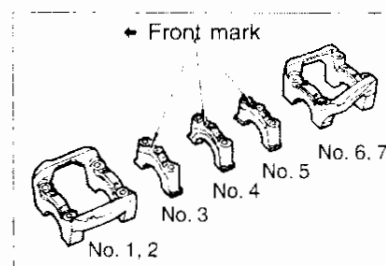

**(RB20DE / DET)**

- Make sure to install the main bearing cap in correct orientation when installing.

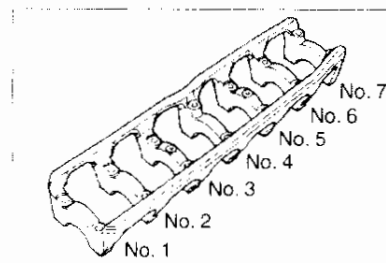

**[Point 24] Main bearing inspection**

- The bearing end should protrude when installing the main bearing to the cylinder block or main bearing cap. This protrusion is called the crush height.

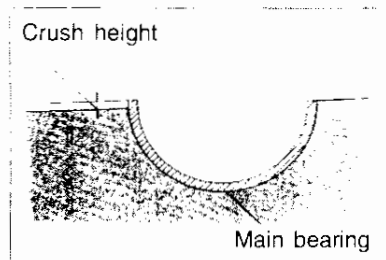

**[Point 25] Main bearing oil clearance**

**Using bore gauge and micrometer (Method A)**

- Install main bearing in cylinder block and attach bearing cap. Tighten bearing cap bolts to specified torque and measure bearing inside diameter.
- The oil clearance distance can be calculated from the values for outside diameter of the crank journal measured in [Point 27].

**(Oil clearance) =**

**(Bearing inside diameter) - (Crankshaft outside diameter)**

**Standard value (mm): 0.020 ~ 0.047**

**Limit value (mm): 0.090**

- If oil clearance exceeds the limit value refer to [Point 26] to select suitable bearing.

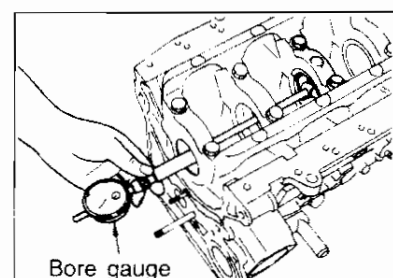

**Using plastic gauge (Method B)**

- Remove all dust and oil from each crankshaft journal and bearing surfaces.
- Cut a piece of plastigauge slightly shorter than the bearing gauge width. Place a plastigauge on crankshaft in direction of axis, care must be taken not to place on oil hole.
- Assemble the main bearing and bearing cap and tighten cap bolts to the specified torque.
- Remove bearing cap and the bearing. Measure plastigauge width on plastigauge scale.

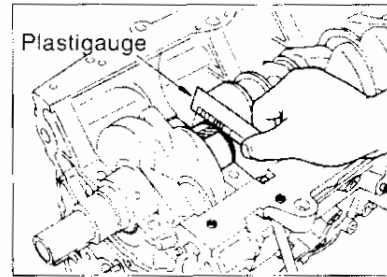

**Caution:**

Do not turn crankshaft while plastigauge is being inserted. If excessive bearing clearance still exists, use a thicker main bearing or undersized bearing so that the specified bearing clearance is obtained when measured by method A as well.

**[Point 26] Main bearing selection and engagement**

- Select correct sized bearing as the main bearing prevents fluctuation in the oil clearance. Five different bearing thicknesses are available to fit the cylinder block bearing housing and crank journal diameter grades.

**Note:**

Selection engagement is performed only for standard size.

- Check the bearing grade (indicated on bottom face of the cylinder block) and journal diameter grade (indicated on crankshaft No. 1 counterweight front surface) when replacing the main bearing.
- Select main bearing with proper thickness according to the following table.

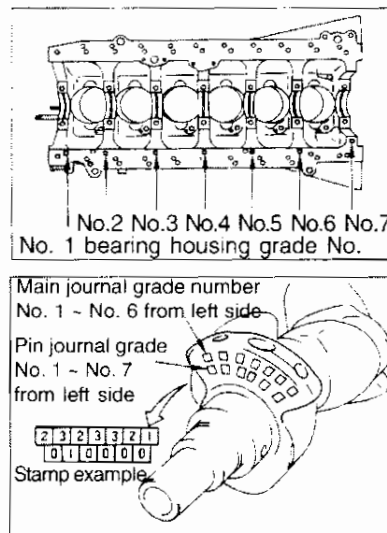

Cylinder block bearing housing inner diameter			Less than 58.654 Greater than 58.645	Less than 58.663 Greater than 58.654	Less than 58.672 Greater than 85.663
Crank journal diameter	Grade No. stamp		0	1	2
Less than 54.975 Greater than 54.967	0	Bearing grade No. Bearing thickness Oil clearance Identification color	STD 0 1.825 / 1.821 0.020 / 0.045 Black	STD 1 1.829 / 1.825 0.021 / 0.046 Brown	STD 2 1.833 / 1.829 0.022 / 0.047 None
Less than 54.967 Greater than 54.959	1	Bearing grade No. Bearing thickness Oil clearance Identification color	STD 1 1.829 / 1.825 0.028 / 0.045 Brown	STD 2 1.833 / 1.829 0.021 / 0.046 None	STD 3 1.837 / 1.833 0.022 / 0.047 Yellow
Less than 54.959 Greater than 54.951	2	Bearing grade No. Bearing thickness Oil clearance Identification color	STD 2 1.833 / 1.829 0.020 / 0.045 None	STD 3 1.837 / 1.833 0.021 / 0.046 Yellow	STD 4 1.841 / 1.837 0.022 / 0.047 Blue

- When using undersized bearings, measure bearing inside diameter when bearing is installed and grind journal so oil clearance conforms to specified clearance.

Size	Thickness (mm)	Grade No.
US0.25	1.960 / 1.952	25
US0.50	2.085 / 2.077	50

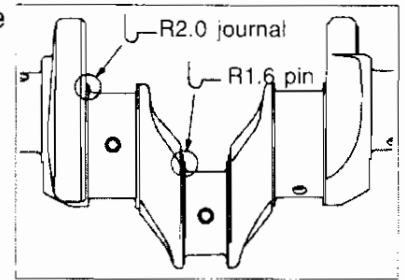

**Caution:**

When crankshaft journal is being ground for use with undersize bearings, do not scratch the fillet roll.

**[Point 27] Crankshaft inspection**

**Out-of-round and taper inspection**

- Use micrometer to measure each journal (No. 1 ~ 7) and each pin (No. 1 ~ 6) in four locations shown in the figure on right.
- The out-of-round value is the difference of the dimensions in directions A and B.
- The taper value is the difference of the dimensions measured at points 1 and 2.

**Out-of-round and taper limit (mm): Below 0.005**

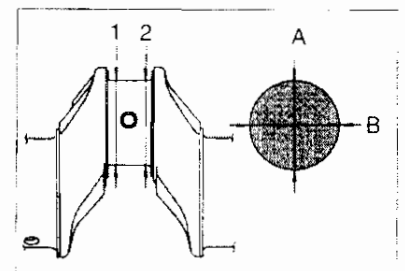

**Pin and journal inspections**

- Use micrometer to measure pin and journal diameters.

**(RB20E)**

**Pin diameter standard value (mm): 41.961 ~ 41.974**

**Journal diameter standard value (mm): 54.951 ~ 54.975**

**(RB20DE / DET)**

**Pin diameter standard value (mm): 44.961 ~ 44.974**

**Journal diameter standard value (mm): 54.951 ~ 54.975**

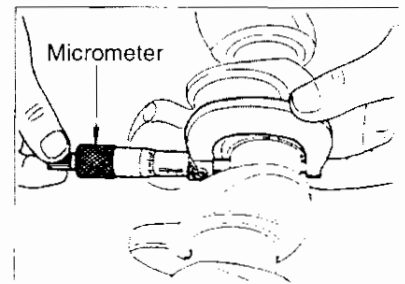

**Curve inspection**

- Use V-blocks on a fixed surface and support journals on both ends of crankshaft (No. 1 and No. 7).
- Position the dial gauge vertically on middle of No. 4 journal as shown in the figure on the right.
- Turn crankshaft by hand and read dial gauge movement.
- The Run-out is equal to half of dial gauge movement.

**Limit value (mm): 0.05**

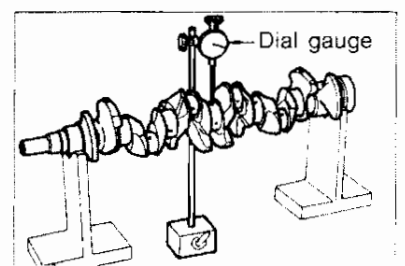

**[Point 28] Cylinder block inspection and correction**

- Remove all oil and water deposits, gasket, seal material and carbon from cylinder block.

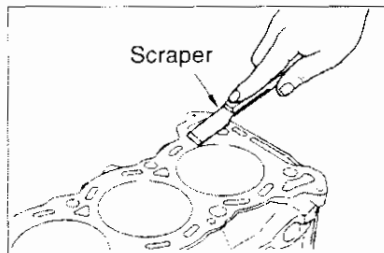

**Upper surface distortion and wear inspection**

- Clean upper face of the cylinder block and measure the distortion in six directions.

**Limit (mm): 0.1**

- If the distortion exceeds the specified limit, resurface the face with surface grinder or replace block if necessary.

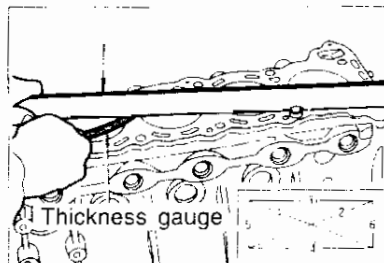

**Cylinder inside diameter inspection**

- Use bore gauge to measure cylinder bore for out-of-round and taper. Measure in three vertical locations (A, B & C) and two directions (X & Y) for a total of six locations.

<b>Cylinder inside diameter standard (mm)</b>	77.950 ~ 78.000
<b>Wear limit (mm)</b>	0.2
<b>Out-of-round limit (mm)</b>	0.015
<b>Taper limit (mm)</b>	0.010

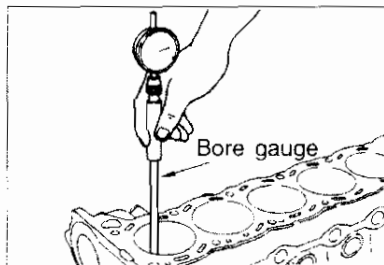

- Out-of-round measurement is the difference of measurements in two directions (X & Y).
  - Taper is the difference of measurement at top and bottom (A & C).
- Perform honing or boring when abnormality is found.

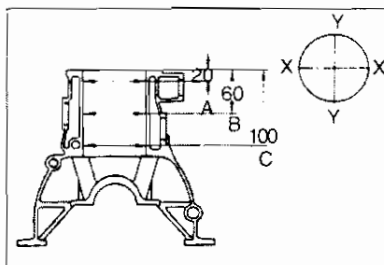

**Cylinder honing**

- There are three types of oversize pistons, STD (Standard +0.02), OS (0.5) and OS (0.1). When oversize pistons are used, hone the cylinder so the clearance between the piston and the cylinder conforms to the specified value described in [Point 29]. Oversize piston rings must be used that fit the oversize piston.

**[Point 29] Piston and cylinder bore clearance**

- The clearance can be calculated from the measured values for the piston skirt outside diameter [Point 15] and cylinder inside diameter [Point 28] (X direction B location).

**(Clearance) = (Cylinder inside diameter) - (Piston skirt outside diameter)**

**Standard at normal temperature (mm):**

<b>(RB20E)</b>	<b>0.025 ~ 0.045</b>
<b>(RB20DE / DET)</b>	<b>0.015 ~ 0.035</b>



## EN3 ECCS (ELECTRONICALLY CONCENTRATED ENGINE CONTROL SYSTEM)

### 1. TROUBLE DIAGNOSIS 1-1 TROUBLE DIAGNOSIS PROCEDURE

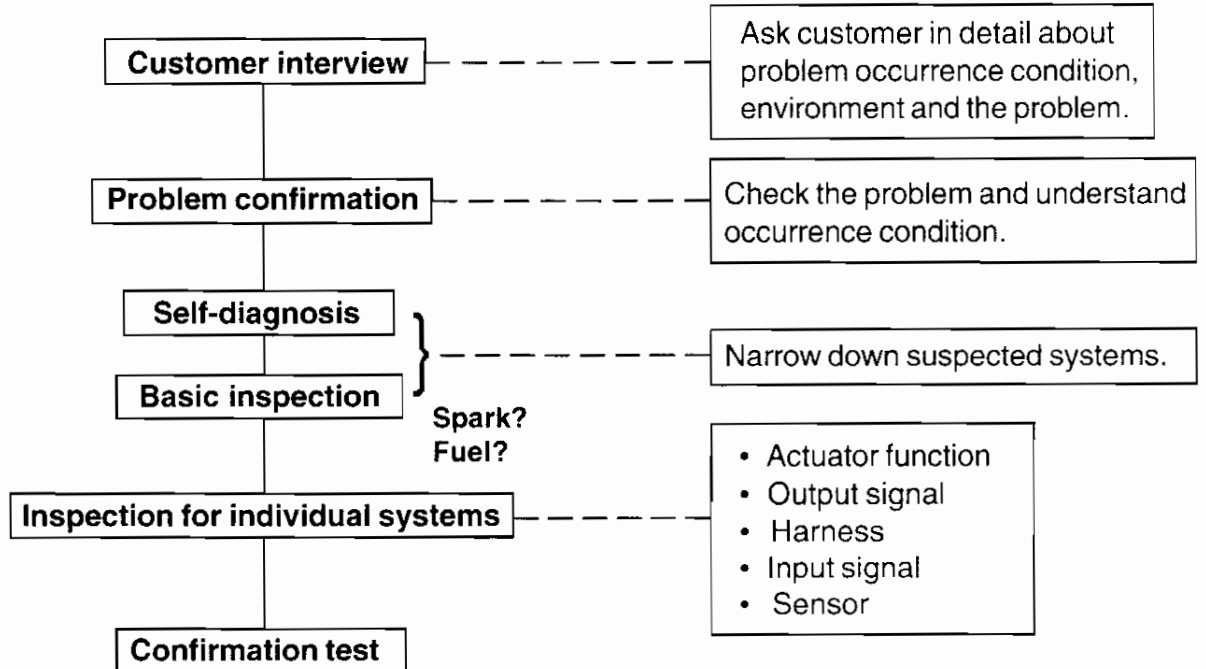

#### Caution:

Engine problems are roughly divided into two types: problems relating to engine main body and those related to control system. This section explains the trouble diagnostic method for the control system under the assumption that the engine main body is normal. Consequently, attention should also be paid to the condition of the engine main body and gasoline quality.

**FOR ACCURATE & QUICK DIAGNOSIS****Cautions when carrying out diagnosis**

- Remove the battery terminals and place key switch in OFF position when removing or connecting ECCS C/U harness connector from ECCS C/U.
- Position the connector and tighten installation screw until orange projection is level with surface when connecting ECCS C/U harness connector.
- Check the connector pin terminals for any bent or deformation when removing or connecting ECCS C/U harness connector.
- Make sure to carry out components function check and ECCS C/U input signal check before replacing ECCS C/U.
- After "Diagnosis procedures" carry out the test drive and self-diagnosis.
- Short circuit will occur if probes from same position comes in contact when measuring battery voltage of ECCS C/U components using circuit tester. Make sure to connect one side of tester probe to different place.

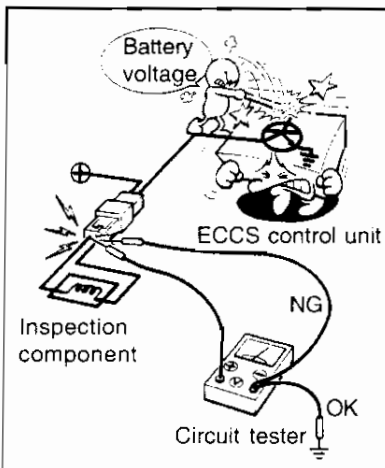
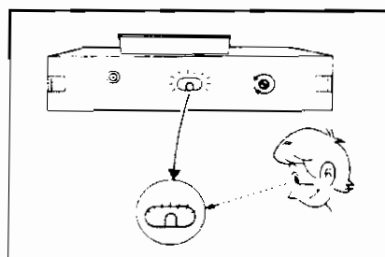
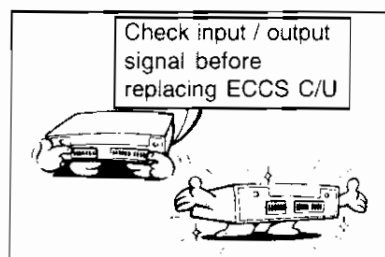
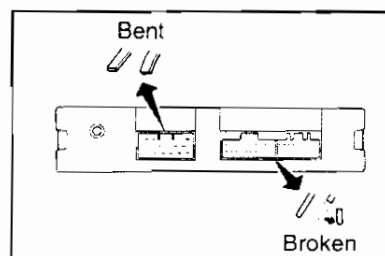
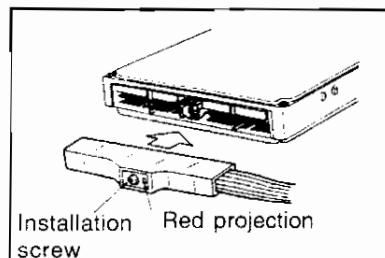
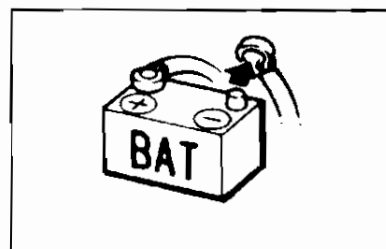

## Cautions when handling ECCS C/U

### ECCS C/U installation

- Only install ECCS C/U specified for your vehicle.
- Do not apply unnecessary power to installation bracket.

### Connector installation

Keep the following points in mind when removing & installing the connector:

#### Removal

- Make sure the ECCS relay is "OFF" after turning off the key switch.
- Hold the connector body to remove connector. Never pull the harnesses to remove.

#### Installation

- Install connector when key switch is in "OFF" position.
- Check the ECCS C/U side connector pin for any bent or deformation before installation.
- Tighten the bolts securely until red projection is level with surface.

### ECCS voltage

- Never connect the battery in reverse.
- The battery voltage should be between 10V ~ 16V.

### Idle revolution adjustment volume

- Do not turn the knob over the lock position.
- Do not operate the adjustment volume when below 0°.

### Moisture & oil content

- Care must be taken to keep all rain drops and water droplets away from ECCS C/U.
- Take note of water droplets from rapid temperature change. Make sure ECCS C/U has dried completely before installing to the vehicle.
- Do not let oil content adhered to the connector device.
- Avoid cleaning ECCS C/U using benzine or white spirit.

### Dropping & strong impact

- Do not drop, tap or apply strong impact to ECCS C/U device.
- Do not use ECCS C/U unit with bent top or bottom cover.

### ECCS C/U screw & cover

- Do not remove ECCS C/U cover.
- Do not rotate screws on ECCS C/U body.



**(2) Problem confirmation**

- Customer's explanation is often insufficient in clarifying the status of the problem. Reproduction of the problem on the actual car and its confirmation and analysis are therefore essential. If unable to reproduce the problem, ask the customer in detail about its occurrence conditions and try to reproduce it under the indicated conditions. If unable to reproduce, manually shake the concerned harness to check for poor contacts or other problems.
- It is also recommended to collect and analyse the data using CONSULT while driving.
- When checking the actual vehicle, record data on normal portions to assist in diagnosing a problem.

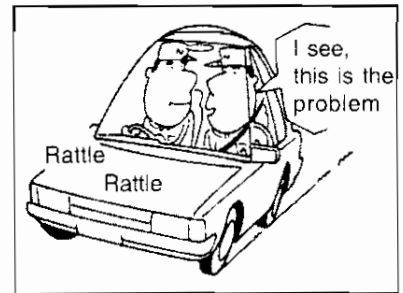

Variant factor	Affecting component	Target	Method
Air fuel ratio	Pressure regulator	Lean	Carry out active test and function test using CONSULT. OR remove vacuum hose and apply negative pressure using vacuum pump.
		Rich	Carry out active test and function test using CONSULT. OR remove vacuum hose and apply pressure using vacuum pump.
Ignition timing	Crank angle sensor	Decrease angle	Rotate crank angle sensor clockwise.
		Increase angle	Carry out active test and function test using CONSULT. OR rotate crank angle sensor anti-clockwise.
Air fuel ratio control	O <sub>2</sub> sensor	Shutdown temporarily	Carry out active test and function test using CONSULT. OR remove O <sub>2</sub> sensor harness connector.
	Control unit	Operation check	Carry out active test and function test using CONSULT. OR carry out self diagnosis mode 2 in 2000 rpm.
Idle revolution	AAC valve	Increase	Carry out active test and function test using CONSULT. OR rotate idle adjustment screw anti-clockwise.
		Decrease	Carry out active test and function test using CONSULT. OR rotate idle adjustment screw clockwise.
Harness cables	Harness connector or wiring	Default connector contact	Shake or tap lightly.
		OR wiring default	Turn on the engine quickly and check default contact caused by engine torque movement.
Temperature	Control unit	Cool down	Cool down using ice etc. Do not overcool the unit.
		Warm up	Warm it up using drier etc. Do not overheat the unit.
Moisture	Electronic component	Moisten	Moisten Do not pour water directly on unit.
Electricity load	Switch load	Apply load	Turn ON the headlight switch, Air conditioner, rear defogger etc.
Idling switch condition	Control unit	ON-OFF switch	Operate acceleration (Open / Close)
Ignition spark	Timing light	Correct ignition	Check each cylinder ignition using timing light flashing.

**(3) Self-diagnosis**

- If problems are attributable to the ECCS signal system, problem diagnosis should be narrowed down using the self-diagnostic function.

<b>What happened up to present?</b>	Self-diagnosis
<b>How is the signal system at present?</b>	Real-time diagnosis or switch ON/OFF diagnosis using the CONSULT "Data monitor" function.

**(4) Basic inspection**

- Check to see if three elements of combustion are functioning normally. Find out which system is faulty: Fuel system, ignition system or idling control system.

- |                        |   |
|------------------------|---|
| <b>Fuel?</b>           | Are injector fuel pump operating?           |
| <b>Ignition?</b>       | Are spark present?                          |
| <b>Idling control?</b> | Is AAC valve operating?                     |
| <b>Air-fuel ratio?</b> | Is air-fuel ratio feedback function normal? |

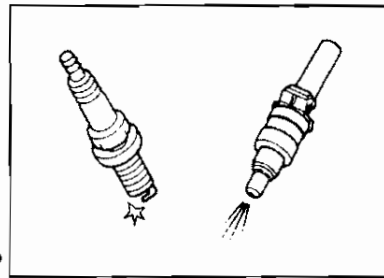

**(5) Individual system inspection**

- An effective method to carry out ECCS diagnosis is to check the control unit output signal first. According to the results of the output signal, continue diagnosis by checking input signals, individual parts such as actuator and sensors.

**[Procedures]**

**Note:**

The input data must be monitored first when using CONSULT.

(Only checking the output data does not provide accurate results).

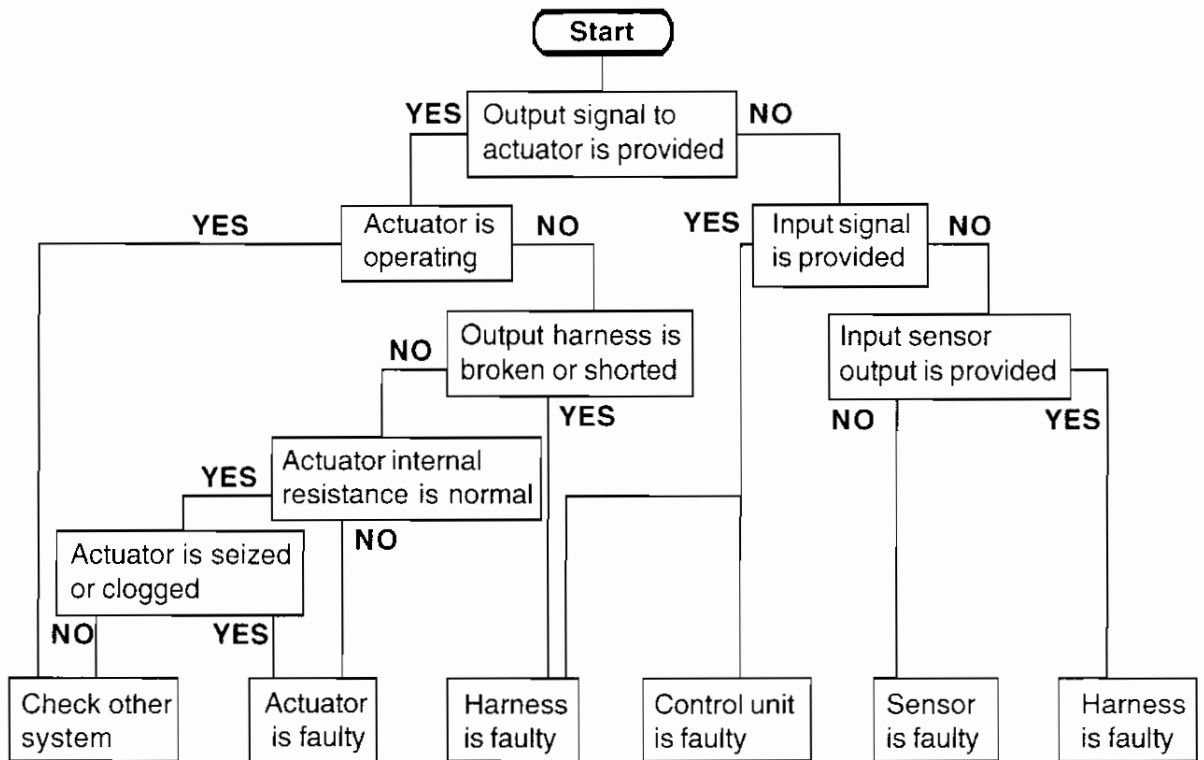

**[Analysis]**

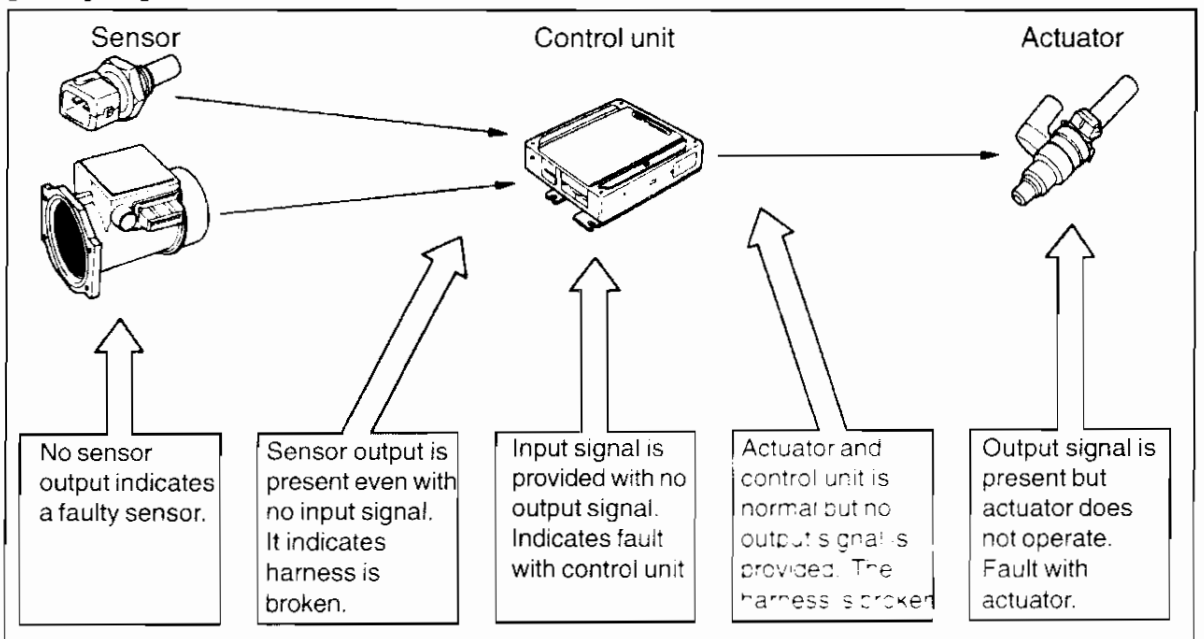

**(6) Trouble diagnosis using measuring instruments**

(Operations in square frames  to be performed with CONSULT.

1. Reproducible problems

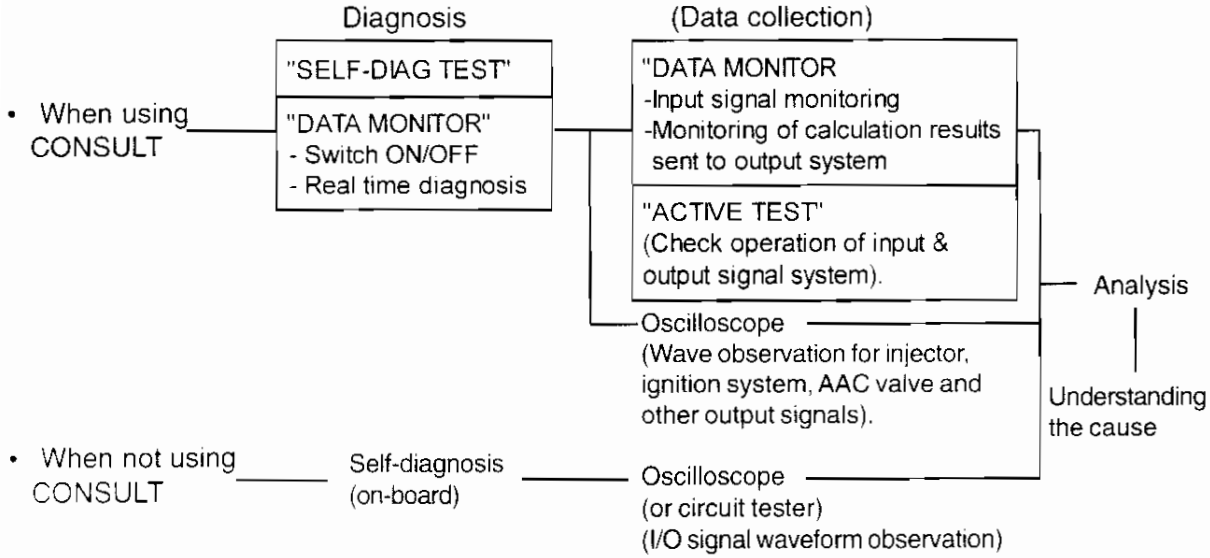

2. Non-reproducible problems

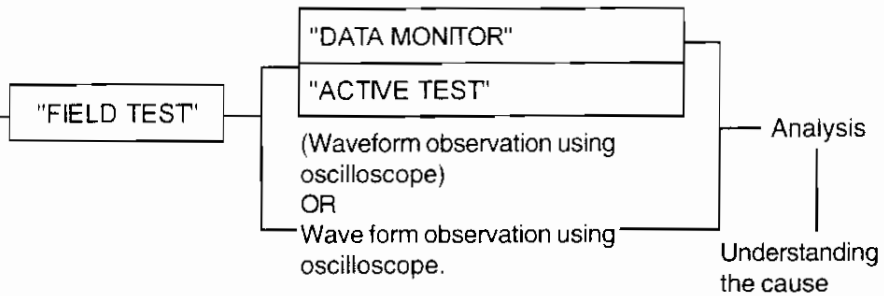



**1-2 MAJOR ECCS INPUT SIGNALS AND CONTROL ITEMS**

It is important to understand the relationship between the input signal and control items (output) of ECCS to efficiently determine the cause of problems.

INPUT	OUTPUT	FUEL INJECTOR CONTROL	IGNITION CONTROL (Power transistor, IGN coil)	IDLE CONTROL (AAC valve)
Crank angle sensor - 180°, 120° signal		Determination of injector injection timing. Engine rpm input signal.	Ignition timing start point.	Engine rpm input signal.
Crank angle sensor 1° signal		Engine speed input signal.	Ignition timing count.	Engine speed input signal.
Air flow meter		Intake air volume measurement and control of injector injection pulse width.	Ignition timing control.	
Water temperature sensor		Engine temperature enrichment correction. Fuel cut range change.	Ignition timing alteration due to water temperature.	Target speed change according to water temperature.
Start signal		Start time enrichment.	Ignition timing control during cranking.	
Throttle valve switch (Idle contact point)		Fuel cut due to ON signal. ON-OFF time enrichment.	Ignition timing change.	Idle control start by ON signal.
Throttle sensor		Fuel injection interruption. Enrichment correction during acceleration. Fuel cut judgement during speed change. Intake air volume measurement.		
Vehicle speed sensor		Fuel cut changeover vehicle speed. Fuel cut at 0km/h vehicle speed. Transmission shift position.		Idle control start at when vehicle speed is below 8 km/h.
Exhaust gas sensor		Pulse width control by air-fuel ratio feedback.		
Detonation sensor			Ignition timing change.	
Battery voltage		Pulse width correction.	Excitation angle change.	Target rpm change.
Air conditioner switch				Target rpm change after engine warms up.
Neutral switch			Ignition timing change (at idle).	Idle control start in neutral position.
Power steering switch				Prevention of engine speed reduction when power steering is turned.

**1-3 DIAGNOSIS CHART ITEM BY PHENOMENON**

- (1) Unable to start ..... No initial combustion.
- (2) Unable to start ..... Initial combustion occurs but it is not complete.
- (3) Difficult to start ..... Hard to start when engine is cold.
- (4) Difficult to start ..... Hard to start after engine warm up.
- (5) Difficult to start ..... Hard to start when engine is hot or cold.
- (6) Poor idling ..... Fast idling inoperative.
- (7) Poor idling ..... Low idle rpm (after warm up).
- (8) Poor idling ..... High idle rpm (after warm up).
- (9) Unstable idling ..... Engine is cold.
- (10) Unstable idling ..... After engine warm up.
- (11) Poor driveability ..... Engine breathing.
- (12) Poor driveability ..... Knocking.
- (13) Poor driveability ..... Lack of output, poor acceleration, poor response.
- (14) Engine stalls when start driving.
- (15) Engine stalls while idling.
- (16) Engine stall while driving.
- (17) Engine stall when decelerating or immediately after stopping.
- (18) Engine stall when electrical load or power steering load is applied.

**Diagnosis chart by phenomenon**

(1) Unable to start ..... No initial combustion

**[Analysis]**

- Ignition spark is not generated or no fuel is injected.
- Check if the fuel pump is rotating.
- If there is no ignition spark is generated and no injector operating noise is heard, check the control unit input (crank angle sensor signal) or control unit power supply.
- If the injector is operating but no spark is generated, control unit and crank angle sensor can be judged as normal. Check the ignition output system (power transistor, ignition, coil etc.)
- If ignition out spark is generated but injector is not operating, check the ignition output system (injector power supply, harness etc.)

**[Chart]****FUEL PUMP?**

- Operating? ————
- Check fuel hose for tension in CONSULT active test mode.
  - OR
  - Check if pump operating noise can be heard for five seconds after turning ON the ignition. (If not check fuel pump system)

**INJECTOR?**

- Operating? ————
- Injector noise can be heard when cranking
  - OR
  - Check using CONSULT data monitor mode if injector pulse is output when cranking engine.
  - If not correct
  - [ • Check control unit terminal voltage when cranking engine. ]
  - [ • Check injector power supply circuit. ]
  - [ • Check crank angle sensor input signal. ]

**IGNITION SPARK?**

- Is there a spark? ————
- Check if tachometer needle moves during cranking.
  - Check using real-time diagnostic mode (CONSULT data monitor).
  - Check using timing light.
    - Remove the plug and check for actual spark.
  - If not correct
  - [ • Check control unit output signal (ignition signal) ]
  - [ • Check control unit input signal (crank angle sensor) ]
  - [ • Check power transistor and ignition coil resistance value. ]

(2) Unable to start ..... Initial combustion occurs but it is not complete.
---

**[Analysis]**

Occurrence of initial combustion means that sparks are created. The following three cases are possible.

1. Initial combustion only.
  - Is fuel system working? (fuel pump, injector etc.)
2. Engine fires incompletely.
  - Check if fuel injection quantity is too small or large.
    - Check the fuel pressure.
    - Check if water temperature enrichment is provided.
    - Check if start time enrichment is provided.
  - Check if ignition timing is normal.
3. Engine fires completely if accelerator pedal is pressed and depressed.
  - Check if AAC valve operation is normal.

**[Chart]****FUEL PRESSURE?**

Is pump operating? — Check fuel hose tension in CONSULT active test mode.  
 OR  
 Check if pump operating noise can be heard for five seconds after turning ON the ignition.  
 Is fuel pump operating during cranking?  
 (If not check fuel pump system)

**INJECTION QUANTITY?**

Water temperature enrichment provided? — Check water temperature of CONSULT data monitor mode.  
 OR  
 Disconnect water temperature sensor and check for any change.
 

- Check water temperature resistance value.
- Check water temperature sensor output voltage.

 Start time enrichment provided? — Check "START" signal ON/OFF (CONSULT data monitor mode).

**IDLING CONTROL?**

Is idling rpm increased? — Check AAC valve operation (CONSULT active test mode).  
 — Check if AAC valve is fully closed.  
 — Check AAC valve circuit for disconnection or loose connectors.

**IGNITION SYSTEM?**

Ignition timing normal? — Try to advance or retard timing angle.  
 Is ignition correct? — Check spark plugs for fouling.  
 — Check for ignition misfiring.  
 (Check using a timing light or CONSULT real-time diagnostic mode).

(3) Difficult to start ..... Hard to start when engine is cold.
---

**[Analysis]**

Inspect the system relating to water temperature as this problem only occurs when the engine is cold.

- Fuel injection enrichment from engine temperature sensor signal is not functioning when temperature is low.
- Idling speed control is not functioning.
- Start-time enrichment is not functioning.
- Cranking speed is too low.

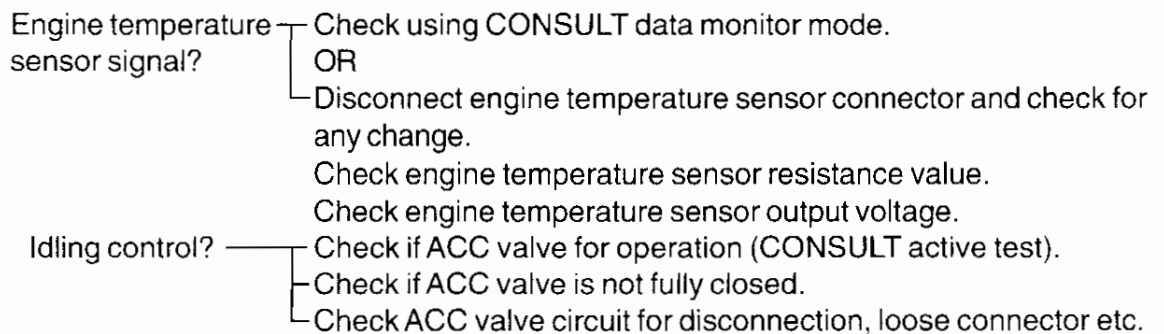
**[Chart]****ENGINE TEMPERATURE CORRECTION?****START-TIME ENRICHMENT?**

\_\_\_\_\_ Using CONSULT data monitor mode check if START signal is provided.

**CRANKING SPEED?**

\_\_\_\_\_ Is battery normal?  
\_\_\_\_\_ Inspect starter, starter cables (resistance, poor contact etc.)

(4) Difficult to start ..... Hard to start after engine warm up.
--

**[Analysis]**

This problem may also be related to the water temperature control.

- Check engine temperature correction is inaccurate.
- Check if fuel pressure is correct or if air bubbles are generated in the fuel when the engine is hard to start, especially when water temperature is high.
- Check if engine cranking speed is low.

**[Chart]****ENGINE TEMPERATURE CORRECTION?**

Engine temperature sensor signal? — Inspect using CONSULT data monitor.  
 OR  
 — Disconnect engine temperature sensor connector and check for any change.

- Check engine sensor resistance value.
- Check engine temperature sensor output voltage.

**FUEL PRESSURE?**

Increase fuel pressure to check — Remove vacuum hose for pressure regulator or clamp return hose.

**CRANKING SPEED?**

— Is battery normal?  
 — Inspect starting system.

(5) Difficult to start ..... Hard to start regardless of engine temperature.
--

**[Analysis]**

Spark arc is created but air-fuel ratio could be incorrect.

- Check fuel pressure.
- Check fuel injection quantity. (Is engine temperature correction accurate?)
- Check if idling speed is controlled.
- Check if cranking speed is too low.

**[Chart]****FUEL PRESSURE?**

- |                                 |   |  |
|---------------------------------|---|--|
| Fuel pump?                      | — | Use CONSULT active test mode to check fuel hose tension.<br>OR<br>Check if you can hear pump operation noise for five seconds after turning ignition switch ON.  |
|                                 |   | <ul style="list-style-type: none"> <li>• Check if you can hear pump operation noise when cranking.</li> <li>• Check if fuel pressure is approx. 2,5 ~ 3 kg/cm<sup>3</sup>. (the value differs depending on CA18i, RB20SOHC and DOHC).</li> </ul> |
| Increase fuel pressure to check | — | Disconnect vacuum hose for pressure regulator and check for any change. (or clamp return hose)   |
| Fuel system for clogging        | — | Inspect fuel filter.   |

**ENGINE TEMPERATURE CORRECTION?**

- |                                   |   |   |
|-----------------------------------|---|---|
| Engine temperature sensor signal? | — | Inspect with CONSULT data monitor.<br>OR<br>Disconnect engine temperature sensor connector and check for any change.  |
|                                   |   | <ul style="list-style-type: none"> <li>• Check engine temperature sensor resistance value.</li> <li>• Check engine temperature sensor output voltage.</li> </ul>                    |
| Idling control?                   | — | Check if AAC valve operation is normal (CONSULT active test).<br>Check if AAC valve is not fully closed.<br>Check AAC valve connector circuit is disconnected, loose connector etc. |

**IGNITION SYSTEM?**

- |                            |   |  |
|----------------------------|---|--|
| Ignition misfiring         | — | Check in real-time diagnostic mode (CONSULT data monitor).<br>Check crank angle sensor output for missing pulses (CONSULT data monitor mode or with oscilloscope).<br>Is spark plug gap normal?<br>Check for any leak from high-tension cable. |
| Is ignition timing normal? | — | Check by advancing or retarding the angle.   |

**CRANKING SPEED?**

- |   |                        |
|---|------------------------|
| — | Is battery normal?     |
| — | Check charged state.   |
| — | Check starting system. |

(6) Poor idling ..... Fast idling inoperative.
--

**[Analysis]**

This problem may have been caused by abnormal control of ACC valve and air regulator as idling speed is controlled by these device.

The air-fuel ratio and ignition timing also relate to this problem.

**[Chart]****IDLE CONTROL SYSTEM?**

- |                         |           |                            |   |
|-------------------------|-----------|----------------------------|---|
| Air regulator operation | AAC valve | Engine temperature signal? | <ul style="list-style-type: none"> <li>Is air regulator resistance normal?</li> <li>Is air regulator seized?</li> <li>Is AAC valve operation signal shown?</li> <li>Is AAC valve operation normal (CONSULT active test mode).</li> <li>Is idle judgement ON? (CONSULT data monitor mode).</li> <li>Check for ACC valve circuit for breaks or loose connectors.</li> <li>Check using CONSULT data monitor.</li> <li>OR</li> <li>Disconnect engine temperature sensor connector and check for any change.               <ul style="list-style-type: none"> <li>• Check engine temperature sensor resistance value.</li> <li>• Check water temperature sensor output voltage.</li> </ul> </li> </ul> |
|-------------------------|-----------|----------------------------|---|

**AIR-FUEL RATIO?**

- |                         |                       |   |
|-------------------------|-----------------------|---|
| Enrich mixture to check | Lean mixture to check | <ul style="list-style-type: none"> <li>Increase fuel pressure (Disconnect pressure regulator vacuum hose or CONSULT active test).</li> <li>Reduce the fuel pressure (CONSULT active test or apply negative pressure greater than -500 mmHg).</li> </ul> |
|-------------------------|-----------------------|---|



(7) Poor idling ..... Low idle rpm (after warm up).
---

**[Analysis]**

Idling speed is controlled by AAC valve. A low rpm means insufficient auxiliary air volume through AAC valve.

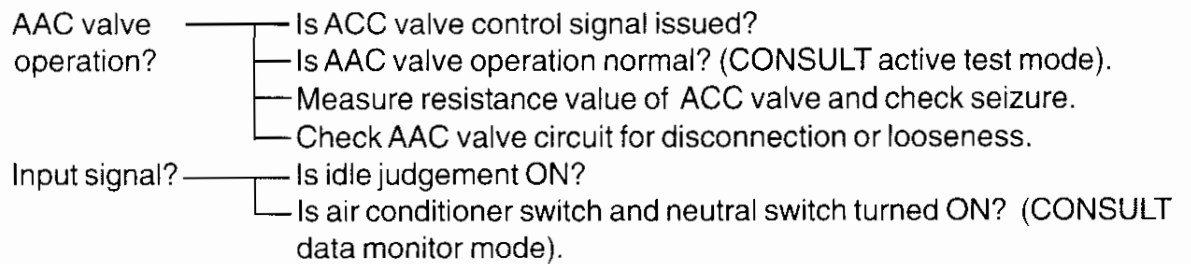
**[Chart]****IDLE CONTROL SYSTEM?****IS IGNITION TIMING NORMAL?**

(8) Poor idling ..... High idle rpm (after warm up).

**[Analysis]**

High idling can be caused by following points below:

- Low engine temperature signal.
- Throttle valve switch (Idle judgement) is OFF.
- AAC valve is seized.
- Air regulator is not energized.
- Air regulator is seized.
- Control unit adjustment volume is set to HIGH.
- Throttle valve is open.
- Air is sucked in.

**[Chart]**

**IDLE CONTROL SYSTEM**

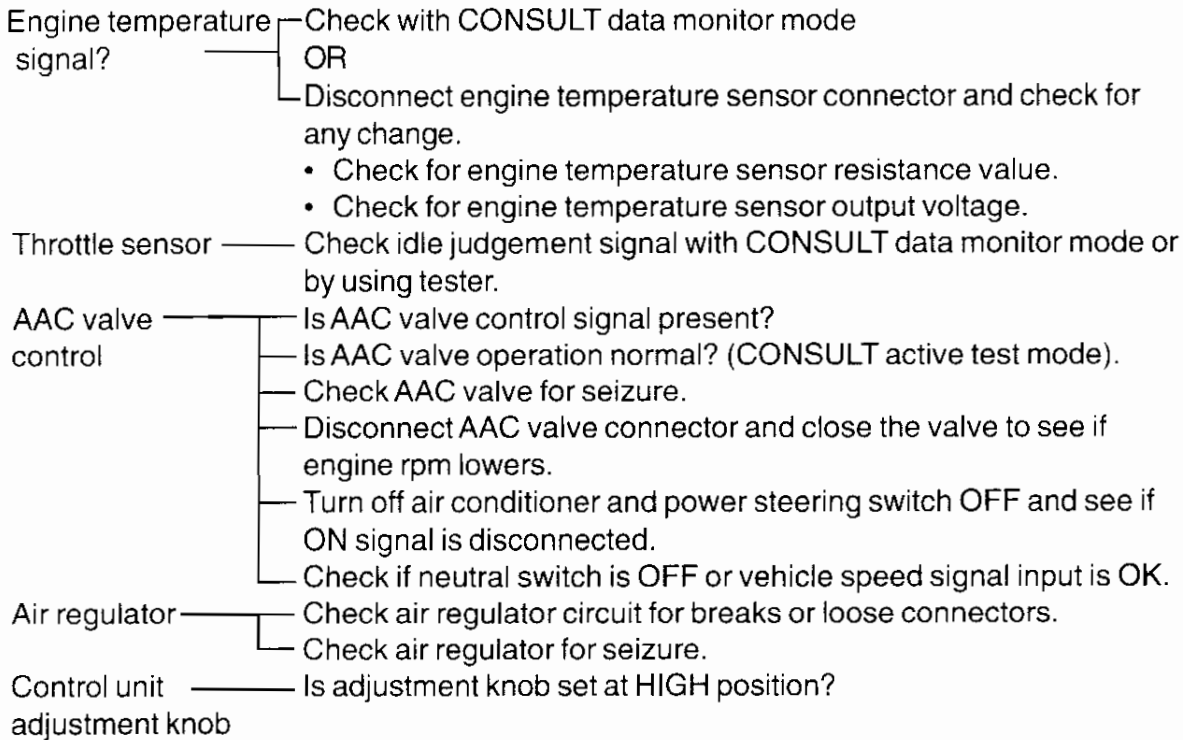

**OTHERS**

- Throttle valve — Is valve open? (Check for wire binding).
- Air suction — Block blow-by hose passage and check for any change.

(9) Unstable idling ..... Cold engine only.
---

**[Analysis]**

Since idling is unstable only when the engine is cold, cause of this problem can be narrowed down to the relationship between the engine temperature and idle control system. It also relates to the air-fuel ratio, ignition timing, misfiring etc.

**[Chart]****IDLE CONTROL SYSTEM**

Engine temperature—Inspect using CONSULT data monitor mode.

sensor signal      Check engine temperature resistance value.

Check engine temperature output voltage.

AAC valve ——— See if the valve is closed completely. See if idle adjustment is within specification.

Is AAC valve operation normal? (CONSULT active test).

**AIR-FUEL RATIO?**

Make the mixture rich or lean ——— Use CONSULT active test mode to make the mixture rich or lean or disconnect pressure regulator vacuum hose or apply additional vacuum.

**IGNITION SYSTEM**

Ignition timing normal? ——— Advance or retard ignition timing and check for any change.

Ignition misfiring ——— Check crank angle sensor by real time diagnostic method (CONSULT data monitor).

Check spark plug condition.

Check ignition system condition by real time diagnostic method (CONSULT data monitor).

## (10) Unstable idling ..... After warm up.

**[Analysis]**

Relates to various factors including air-fuel ratio, ignition system and compression. It is necessary to determine factors beginning with items that are easy to check.

- Idle rpm control system .... How is AAC valve operation?
- Air-fuel ration ..... Fuel pressure?
  - Injection quantity? (Enriched?)
  - Air suction?
- Ignition system ..... Ignition timing
  - Ignition misfiring (Missing signal pulse)
- Engine main unit ..... Poor compression

**[Chart]****IDLE CONTROL SYSTEM**

Disable control function — Disconnect AAC valve connector and check for any change.

Control circuit —

- Check if control signal is present and check signal condition.
- Is AAC valve operation normal? (CONSULT active test).
- Disconnect AAC valve connector and check by adjusting with IAS.
- Check AAC valve for seizure.
- Check if idle judgment is ON (CONSULT data monitor).
- Check circuit for breaks and connectors for looseness.

**AIR-FUEL RATIO**

Enrich the mixture — CONSULT active test or remove pressure regulator vacuum hose. OR clamp return hose.

Lean the mixture — Reduce the mixture ratio by using "FUEL INJECTION" in CONSULT active test mode, or applying vacuum greater than -500mmHg.

Stop feedback — Perform CONSULT active test  
OR  
Disconnect engine temperature sensor connector and check for any change.
 

- Check engine temperature sensor resistance value.
- Check engine temperature sensor output voltage.

Air suction — Check vacuum line and blow-by hose.

**IGNITION SYSTEM**

Ignition timing — Advance or retard ignition timing angle and check for any change. normal?

Ignition misfiring —

- Check ignition system by real-time diagnosis (CONSULT data monitor mode).
- Check condition of the crank angle sensor by rea-time diagnosis.
- Check condition of the spark plug.

**ENGINE MAIN BODY**

Compression pressure — Measure compression pressure (Check valve timing, valve seats, piston rings etc.)

(11) Poor drivability ..... Engine breathing.
---

**[Analysis]**

It is necessary to first verify if the problem occurs during acceleration or during cruising.

**1. During acceleration**

- Engine breathing while accelerator pedal is depressed may be caused by momentary misfiring or momentary occurrence of lean mixture (ie. no interrupt injection).
- Inclination of engine during acceleration etc. can increase tension of harness or air duct that can cause poor contact.
- Clogging in fuel system is cause for engine breathing. Sufficient fuel pressure cannot be maintained during acceleration.

**2. During cruising**

- Lean mixture and engine breathing caused by poor feedback of air-fuel ratio data.
- Misfiring of ignition system caused by leaks.
- Poor contact or malfunction of signal system, use of low quality gasoline.

**[Chart]****1. During acceleration****AIR-FUEL RATIO**

- |                       |   |  |
|-----------------------|---|--|
| Stop feedback         | — | Perform CONSULT active test<br>OR<br>Disconnect exhaust gas sensor.  |
| Enrich mixture        | — | Perform CONSULT active test or disconnect engine temperature sensor and apply 600 $\Omega$ resistance after warming up the engine. |
| Throttle valve switch | — | Check idle judgement ON/OFF operation in CONSULT data monitor mode.  |
| Throttle sensor       | — | Check if output voltage varies with throttle opening.  |
| Fuel pressure         | — | Check if fuel pressure is maintained even while racing the engine.   |
| Air leak              | — | Check air duct looseness.  |
| Air flow meter output | — | Check output voltage.  |

**IGNITION SYSTEM**

- |                    |   |  |
|--------------------|---|--|
| Ignition misfiring | — | Check signal system (Ignition signal, crank angle sensor signal, air flow meter signal) for instantaneous break by CONSULT data monitor. |
|                    | — | Check spark plug gap.  |
|                    | — | Check for any leak from high tension cable.  |
|                    | — | Check if ignition coil power supply voltage is lowered.  |
| Ignition timing    | — | Check if fail-safe mode is not set due to a detonation sensor error.   |

**2. When cruising****AIR-FUEL RATIO**

- Feedback function ———— Perform CONSULT active test  
OR  
Disconnect exhaust sensor connector.
- Perform exhaust gas sensor monitor diagnosis to see if exhaust gas warning lamp (or control unit red lamp) is flashing or check by CONSULT data monitor.
- Check if exhaust gas temperature warning lamp (or control unit red lamp) is flashing more than five times in ten seconds when engine is running at 2,000 rpm, or check by CONSULT data monitor.
- Throttle valve switch ———— Check idling contact point revolution.

**IGNITION SYSTEM**

- Ignition misfiring ———— Check for instantaneous break signal system using real-time diagnosis (ignition signal, crank angle sensor signal, air flow meter signal) (Use CONSULT data monitor or oscilloscope).

(12) Poor drivability ..... Knocking.
---------------------------------------

**[Analysis]**

This problem may be caused by lean air-fuel mixture, incorrect ignition timing or malfunctioning or engine main unit or cooling system.

- Lean mixture ratio may be caused by fuel enrichment correction not working during acceleration, incorrect air flow meter output, incorrect air-fuel ratio feedback correction.
- Errors in initial ignition timing or knock control system relate to the detonation caused by incorrect ignition timing.
- Other causes can be excessively high cooling engine temperature, increased compression ratio due to carbon deposits in combustion chamber etc.

**[Chart]****AIR-FUEL RATIO?**

- Fuel pressure? ———— Check if fuel pressure remains normal when racing.
- Enrich mixture ———— Enrich air-fuel ratio (CONSULT active test or disconnect pressure regulator vacuum hose).  
————— Disconnect engine temperature sensor and check for any change.
- Stop feedback ———— Perform by CONSULT active test mode  
OR  
————— Disconnect exhaust gas sensor connector and check for change.  
If any change is noted, check the fuel system (fuel pump, sensor system or clogging in the system).
- Injector clogging ———— Clean with engine conditioner.
- Idle judgement ———— Is throttle sensor OFF when accelerating?

**IGNITION TIMING?**

- Is ignition timing normal?
- Knock control ———— Check if detonation sensor error is indicated by self-diagnosis.  
————— Check harness for disconnection or shorts-circuit.

(13) Poor drivability ..... Lack of output, poor acceleration, poor response.
---

**[Analysis]**

Lack of power, poor acceleration and poor responses are generally caused by insufficient mixture quantity (lack of fuel, lack of air) or incorrect air-fuel mixture ratio.

In the injection system, these problems are caused by lack of ignition energy or incorrect ignition timing.

Lack of compression pressure and excessive friction due to seizure in engine main body are also causes of these conditions.

**[Chart]****MIXTURE AIR QUANTITY, AIR-FUEL RATIO**

- Fuel pressure ——— Check if fuel pressure drops during racing (check for clogging with fuel pump and fuel system).
- Enrich mixture ——— Enrich by CONSULT active test or disconnect pressure regulator vacuum hose.
- Stop feedback ——— Check for change by CONSULT active test or disconnect exhaust sensor connector.
- Injector clogging — Clean with engine conditioner (CONSULT active test or pour conditioner into fuel filter, start engine then race engine).
- Air flow meter ——— Check output voltage.  
output

**IGNITION SYSTEM**

- Spark plug? ——— Is plug gap normal?
- Ignition timing ——— Is ignition timing normal?
  - Check by advancing or retarding ignition timing angle.
  - Check detonation sensor for abnormality (self-diagnosis for harness disconnection and shorts).
- Ignition energy? ——— Check ignition coil power voltage.
  - Check for any leak from high-tension cable.

**ENGINE MAIN BODY**

- Compression ——— Measure compression pressure (Also check valve timing, valve  
pressure? seat contact, piston and rings).

(14) Engine stall when start driving.
---------------------------------------

**[Analysis]**

Engine stall is caused by misfiring when accelerator pedal is pressed or insufficient torque when starting off.

- Misfiring
  - Too lean or too rich air-fuel mixture ratio.
  - Large error in ignition timing.
  - Weak spark.
- Insufficient torque
  - Lean or rich mixture.
  - Insufficient intake air quantity.
  - Insufficient compression pressure.

**[Chart]****SELF-DIAGNOSIS**

\_\_\_\_\_ Check if occurrence of error is stored by self-diagnosis function.

**AIR-FUEL RATIO**

Enrich mixture \_\_\_\_\_ CONSULT active test or disconnect pressure regulator vacuum hose.

Lean mixture \_\_\_\_\_ CONSULT active test or apply vacuum greater than -500mmHg with vacuum hand pump to pressure regulator.

Stop feedback \_\_\_\_\_ Perform CONSULT active test  
 OR  
 \_\_\_\_\_ Disconnect exhaust sensor connector (race engine and return to idle).

Check canister \_\_\_\_\_ Check by blocking purge line.

Throttle valve \_\_\_\_\_ Check if idle judgement is OFF when accelerator is ON (check by switch  
 \_\_\_\_\_ CONSULT data monitor).

\_\_\_\_\_ Check engine temperature sensor.

Throttle sensor \_\_\_\_\_ Check if accelerator opening signal is output.

**IGNITION**

Spark \_\_\_\_\_ Check spark plug condition (fouling, gap, electrodes).

Ignition timing \_\_\_\_\_ Check if ignition timing is correct.

Ignition error \_\_\_\_\_ Check by real-time diagnosis (Perform CONSULT data monitor)

High-tension cable \_\_\_\_\_ Check resistance value and any leak.

**INTAKE AIR QUANTITY**

\_\_\_\_\_ Check if throttle valve opens normally.

\_\_\_\_\_ Check for any leak from turbocharger system. Duct inspection.

**COMPRESSION PRESSURE**

Measure compression \_\_\_\_\_ Check valve timing, valves for incorrect timing, piston, ring for damage.



(15) Engine stall while idling.
---------------------------------

**[Analysis]**

Engine stall during idling may be caused by one of the following conditions. (check idling speed, and then check for misfiring).

- Improper idling speed.
- Improper AAC valve control (Check for delayed response).
- Excessively lean or rich mixture ratio.
- Ignition error.
- Poor connector contacts etc.
- Relation to electrical load ON-OFF.

**[Chart]****SELF-DIAGNOSIS**

————— Check if occurrence of error is stored by self-diagnosis function.

**IDLING CONTROL**

Proper control —————

- Is idling speed normal or adjusted?
- Is AAC valve fully closed? (Check for loose connector).
- Close AAC valve fully and check for any change.
- Is AAC valve control signal issued?  
(Race engine and check voltage).
- Is AAC valve operation normal? (CONSULT active test).
- Disconnect AAC valve connector and check by adjusting IAS.
- See if idle judgement is ON.

**AIR-FUEL RATIO**

Air-fuel ratio ————— Check if exhaust gas temperature warning lamp (control unit red lamp) will flash more than five times in ten seconds when engine is running at 2,000 rpm, or check by CONSULT data monitor.

Enrich mixture ————— Perform CONSULT active test or disconnect pressure regulator vacuum hose.

Lean mixture ————— Perform CONSULT active test or apply vacuum greater than -500mmHg with hand pump to pressure regulator.

Stop feedback ————— Perform CONSULT active test  
OR  
————— Disconnect exhaust gas sensor (Set circuit from racing mode one time and return to idling mode).

Fuel pump ————— Check for pump stop.

Fuel system clogging ————— Race engine and check fuel pressure for drop.

**OTHER**

Poor contact ————— Using real-time diagnosis mod, check ignition signal, crank angle sensor signal and air flow meter signal for instantaneous break and missing pulses. (Use CONSULT data mode or oscilloscope).

Spark plug ————— Check for fouling and plug gap.

(16) Engine stall while driving.
----------------------------------

**[Analysis]**

Engine stall during cruising may be caused by misfiring. If engine stalls during acceleration, it may be caused by misfiring or insufficient torque.

- Too rich or lean air-fuel mixture.
- Ignition error.
- Incorrect ignition timing.
- Insufficient intake air quantity.
- Insufficient compression pressure.
- Misfiring, fuel pump stop, etc. caused by poor electrical contact.

**[Chart]****SELF-DIAGNOSIS**

└─── Check if occurrence of error is stored by self-diagnosis function.

**(1) When cruising****AIR-FUEL RATIO**

Throttle valve switch ─── Check if idle judgement goes OFF at correct time.

Feedback ─── Check if exhaust gas temperature lamp (control unit red lamp) will flash more than five times in ten seconds when engine is running at 2,000 rpm, or check by CONSULT data monitor.

Stop feedback ─── Perform CONSULT active test. OR  
└─── Disconnect exhaust gas sensor connector.

Intake air quantity signal ─── Check for poor contact by CONSULT data monitor (real-time diagnosis).

**IGNITION**

Ignition timing ─── Is ignition timing correct?

Ignition misfiring ─── Check ignition signal, crank angle sensor signal for missing pulses in CONSULT data monitor.

**(2) During acceleration****AIR-FUEL RATIO**

Throttle valve switch ─── Check if idle judgement goes ON-OFF when acceleration pedal is pressed and released (CONSULT data monitor).

Throttle sensor ─── Check if voltage output varies with throttle opening.

Feedback ─── Check if exhaust gas temperature lamp (control unit red lamp) will flash more than five times in ten seconds when engine is running at 2,000 rpm, or check by CONSULT data monitor.

Stop feedback ─── Perform CONSULT active test. OR  
└─── Disconnect exhaust gas sensor connector.

Intake air quantity ─── Check for poor contact by CONSULT data monitor.  
└─── Check for air flow or leak after turbocharger operation.

**MISFIRING**

Ignition timing ─── Is ignition normal?

Ignition misfiring ─── Check ignition signal and crank angle sensor signal for missing pulses in CONSULT data monitor.

(17) Engine stall when decelerating or immediately after stopping.
--

**[Analysis]**

Reduced engine rpm when releasing accelerator pedal can lead to engine stall. Another cause is misfiring.

- Incorrect adjustment of idling control.
- Incorrect air-fuel ratio.
- Ignition error.

**[Chart]****IDLE CONTROL**

Idling speed	Is idling speed normal? Is idle adjustment correct?
Control	<ul style="list-style-type: none"> <li>Check if AAC valve control signal is output.</li> <li>Check if AAC valve operation is normal (CONSULT active test).</li> <li>Check if AAC valve is OK.</li> <li>Check if idle judgement is ON.</li> <li>Check by disconnecting AAC valve connector (AAC fully closed).</li> </ul>

**AIR-FUEL RATIO**

Stop feedback	<ul style="list-style-type: none"> <li>Perform CONSULT active test.</li> <li>OR</li> <li>Disconnect exhaust gas sensor connector.</li> </ul>
Feedback	Check if exhaust gas temperature lamp (control unit red lamp) will flash more than five times in ten seconds when engine is running at 2,000 rpm, or check by CONSULT data monitor.
Enrich mixture	CONSULT active test or disconnect regulator vacuum hose.
Lean mixture	CONSULT active test or apply vacuum greater than -500mmHg with hand vacuum pump to pressure regulator.

**IGNITION**

Ignition misfiring	Check ignition signal, crank angle sensor signal for missing pulses in CONSULT data monitor.
--------------------	--

**ENGINE . A/T FUSION CONTROL**

Control	Carry out self-diagnosis.
---------	---------------------------

(18) Engine stall when electrical load or power steering load is applied.
---

**[Analysis]**

Check if idling is increased when load switch is turned ON (AAC valve correction quantity increases when load is applied).

- Check if ON signal is input from each switch.
- Check if AAC valve is operating.

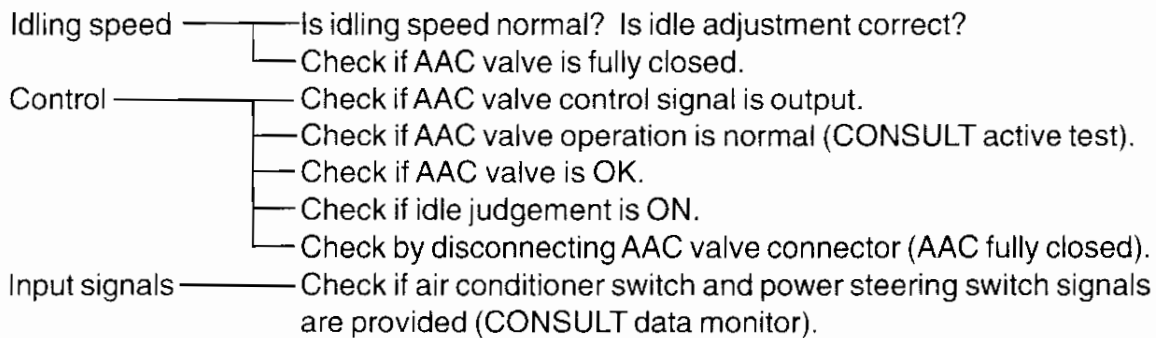
**[Chart]****IDLE CONTROL**

## 2. DIAGNOSTIC SYSTEM

### 2-1 GENERAL

The diagnostic system performance has improved greatly concerning warning indication to drivers, operation of the self-diagnostic system and application of the newly developed electrical system diagnostic tester CONSULT.

#### (1) Enhanced fault warning items

In case when a fault occurs in the ECCS system while driving, the exhaust temperature warning lamp will flash in the instrument panel to warn driver. At the same time, the back up function will activate to ensure the safety of the occupants and the vehicle. The warning items has been increased in recent years.

#### (2) Simplified troubleshooting strategy

The following features have been incorporated for simplifying inspection and problem diagnosis of ECCS system.

##### 1. Improvement of self-diagnostic function

The diagnostic modes have been rearranged and the mode shift and display systems have been simplified.

#### New system

Diagnostic mode		Mode selection	Display
1	Fault warning (Same back up as past display mode)	By diagnostic connector installed near fuse block (Also adjustable by the control unit adjustment knob)	Indicated by exhaust gas temperature warning lamp (Also linked with control unit red lamp)
2	Exhaust gas sensor monitor (Same as past air-fuel ratio feedback display)		
	Self-diagnosis		
(The former ON/OFF switch diagnosis and real-time diagnosis are included in the operations performed by CONSULT as explained in item 2 on the next page.			

#### In the past

Diagnostic mode		Mode selection	Display
1	Back up display	Adjustment by control unit adjustment knob	Indicated by red or green lamps on control unit.
2	Air-fuel ratio feedback display		
3	Normal self diagnosis		
4	Switch ON/OFF diagnosis		
5	Real-time diagnosis		

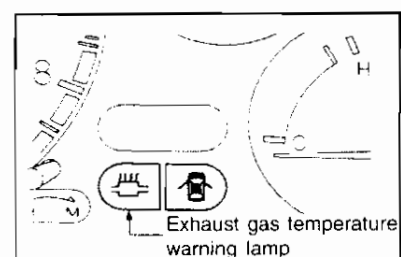
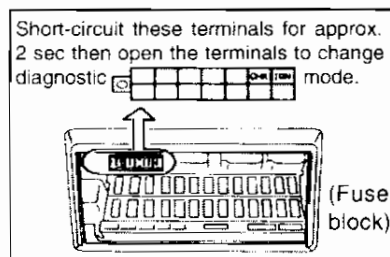

## 2. Introduction of electronic system diagnostic tester for fault diagnosis

To enable use of the newly developed electronic system diagnostic tester CONSULT the diagnostic function have been modified. It will simplify complex diagnosis procedures.

CONSULT is a hand held type compact and lightweight type tester device especially designed for automotive service operations. It can be used by connecting it to the diagnostic connector installed on the vehicle. This tester can permits data display, recording and printing.

MODE		DESCRIPTION		MODE SELECTION	DISPLAY
Diagnostic mode	Self-diagnostic	Self-diagnostic	Same no. of items are possible as previously described 1	Modes can be selected by touch-sensitive keys on CONSULT	Displayed data can be read on the CONSULT screen
	Data monitor	Used to identify major causes of fault according to results of self-diagnosis. Monitor and print input / output data of control unit. Data recording in case of engine fault or engine stall. Former diagnostic modes listed below are included in this monitor item.			
		Exhaust gas sensor monitor	Displays exhaust gas sensor output voltage and lean or rich mixture		
		Switch ON/OFF	Same as previous function		
		Real-time diagnosis	Same as previous function		
Active test	Used to examine major causes of faults according to self-diagnosis results and data monitor. Used to check actuator operation by giving driving signal to the actuator.				
Supplement	Work support	Used to reduce additional operation when checking idling etc.			

SIGNAL NAME	MODE	Self-diagnosis	Data monitor	Active test	Work support
<b>INPUT</b>	Crank angle sensor	<input type="radio"/>	<input type="radio"/>		
	Air flow meter	<input type="radio"/>	<input type="radio"/>		
	Engine temperature sensor	<input type="radio"/>	<input type="radio"/>	<input type="radio"/>	
	Exhaust gas sensor		<input type="radio"/>		
	Vehicle speed sensor		<input type="radio"/>		
	Battery voltage		<input type="radio"/>		
	Throttle sensor	<input type="radio"/>	<input type="radio"/>		<input type="radio"/>
	Idle position		<input type="radio"/>		<input type="radio"/>
	Intake temperature sensor	<input type="radio"/>	<input type="radio"/>		
	Detonation sensor	<input type="radio"/>			
	Ignition switch (Start signal)			<input type="radio"/>	
	Air conditioner, neutral, power steering oil pressure switch, electric load switch			<input type="radio"/>	
	M / T signal	<input type="radio"/>			
	<b>OUTPUT</b>	Fuel injector		<input type="radio"/>	
Ignition signal		<input type="radio"/>	<input type="radio"/>	<input type="radio"/>	<input type="radio"/>
AAC valve			<input type="radio"/>	<input type="radio"/>	<input type="radio"/>
Air conditioner relay			<input type="radio"/>		
Fuel pump relay			<input type="radio"/>	<input type="radio"/>	<input type="radio"/>
Idle supplement solenoid (CA18i)			<input type="radio"/>	<input type="radio"/>	<input type="radio"/>
FICD solenoid (CA18i)			<input type="radio"/>	<input type="radio"/>	
PTC heater (CA18i)			<input type="radio"/>		

**2-2 SELF-DIAGNOSIS**

Self-diagnosis can be performed by indications from warning lamp (exhaust gas temperature warning lamp) in instrument panel display and ECCS control unit red lamp display, or by displaying data on the CONSULT screen.

**(1) EXHAUST GAS TEMPERATURE WARNING LAMP DISPLAY**

There are two diagnostic modes. In each mode, diagnosis is performed by operating the diagnostic connector terminal installed on the vehicle. (Diagnosis can also be performed using the adjustment knob on the control unit). The diagnosis results are displayed by the exhaust gas temperature warning lamp in the combination meter and the red warning lamp on the control unit.

**Basic operation and indications**

Item	Operation	Display
<b>Mode 1</b> Fault warning	Ignition switch ON ↓ Engine rotation	Alarm: Faulty system indicated by warning lamp flashing Normal: warning lamp remains OFF
<b>Mode 2</b>	Self-diagnosis	Fault: Faulty system is indicated by flashing code Normal: Flashing code "55" displayed
	Exhaust gas sensor monitor	Self-diagnosis status described above ↓ Engine rotation Lamp ON means "lean" mixture Lamp OFF means "rich" mixture

**(1) Fault warning mode (Mode 1)**

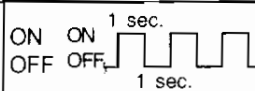
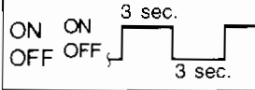
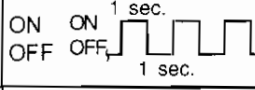
Step	Operation	Display			
<b>1</b>	Turn the ignition switch ON. Mode 1 is normally set by this operation. [Pay attention to the following case that may occur: If the ignition switch is turned OFF in the self-diagnosis mode and then turned ON in a few seconds, the self-diagnosis mode will be executed. In this case, the self-diagnosis mode must be selected (see item (2))]	Indicated by exhaust gas temperature warning lamp in instrument panel and red lamp in control unit (these lamps are linked together).			
			<b>Warning</b>		
			Stop	ON (lamp check)	-
			Rotating	 ON ON 1 sec. OFF OFF 1 sec.	CPU backup (Lamp flashes when engine is OFF)
		 ON ON 3 sec. OFF OFF 3 sec.	Crank angle sensor backup		
		 ON ON 1 sec. OFF OFF 1 sec.	Throttle sensor backup (Lamp flashes when engine is OFF)		
<b>2</b>	Run the engine.	<b>Normal</b>	OFF	ON (lamp check)	-
		Rotating	OFF	OFF	-

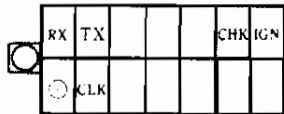
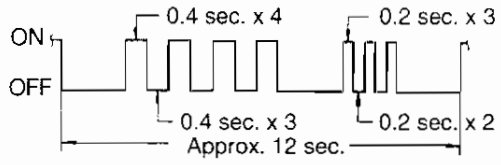

(2) Self-diagnostic mode (Mode 2)

Step	Operation	Display
1	<p>Turn ignition switch ON. Normally fault warning mode is set when ignition switch is turned ON. It is necessary to select diagnostic mode. Short circuit CHK and IGN terminals connected on the diagnosis connector located on the vehicle (near the fuse box) for approx. 2 seconds then separate the terminals. (Diagnosis connector)</p> 	<p>Indicated by exhaust gas temperature warning lamp in instrument panel and red lamp in control unit (these lamps are linked together).  Example: Indication of code number "43".</p> 
2	<p>(The fault warning mode and self-diagnosis mode alternate each time the operation is performed). Stop the engine. (ignition switch in ON position). If the engine is operated in this condition the exhaust gas sensor monitor win the next mode is activated.</p>	

(Reference) Name of diagnostic connector terminals

CHK: Diagnosis start (Check) RX: Control unit data reception

IGN: Ignition power supply

TX: Control unit data transmission

CLK: Transmission synchronization signal (clock)

- : GND

Code No.	Diagnosis Item	Error (code No.) state	CA181	RB20, RB26DETT
11	Crank angle sensor signal system	1° signal or 120° is not input for a certain period of time after starting the engine. Incorrect signal waveform.	○	○
12	Air flow meter signal system	Hot wire disconnection. Disconnection or short-circuit in air flow meter power supply line, ground line or signal system. Signal output is below 0.5 V for a certain period of time during engine operation. Signal output is over 2 V with engine stalled, or when ignition switch is in ON from OFF.	-	○
13	Engine temperature sensor signal system	Break or short-circuit in engine temperature sensor signal system.	○	○
15	Air-fuel ratio learning control system	Air-fuel ratio is lean towards enrich side for a long period of time.	○	-
21	Ignition signal system	Ignition signal is not generated even though crank angle sensor signal is entered.	○	○
34	Detonation sensor signal system	Disconnection or short-circuit in detonation sensor signal system.	-	○
41	Intake temperature sensor signal system	Disconnection or short-circuit in intake temperature sensor signal system.	○	-
43	Throttle sensor signal system	Disconnection or short-circuit in throttle sensor signal system.	○	○
54	A / T transmission system	Disconnection or short-circuit in A/T transmission system.	-	○
55	No error	No abnormality found in any of the above signal systems.	○	○

**How to erase memory**

- (a) Stop the engine in mode 2 and short-circuit terminal "CHK" and "IGN" of the diagnostic connector for over 2 seconds. Then disconnect to erase the memories. (the memory is also erased when the self-diagnosis mode is switched to fault alarm mode).
- (b) When method (a) is not used: If the ignition switch "START" operation is performed successfully 50 times, the memory will be erased automatically. (The memory will be erased automatically every 50 "START" operation of the ignition switch).
- (3) Exhaust gas sensor monitor mode 2)

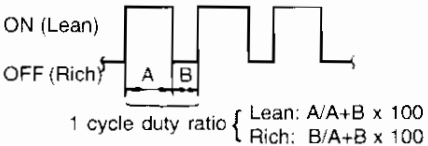
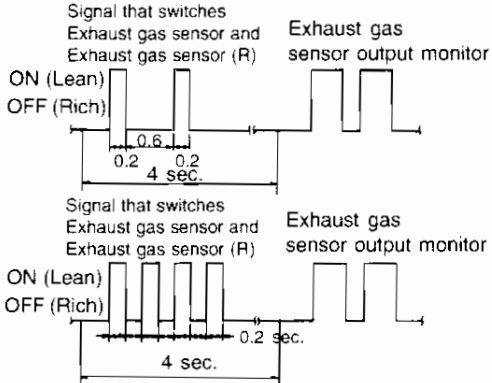
Step	Operation	Display
<p><b>1</b></p> <p><b>2</b></p>	<p>Set ignition switch to "ON" position. Check that self-diagnosis mode is set.</p> <p>Start the engine. Note: The mode can not be changed when engine is operating. After warming up the engine, increase the engine speed until exhaust gas temperature warning lamp (or control unit lamp) starts flashing (approx. 2000rpm) and exhaust gas sensor output (R) mode is set.</p> <p>Caution: The air-fuel ratio feedback control is clamped during idling, check by pressing the accelerator pedal slightly. In this condition check that exhaust gas temperature warning lampflashes. Connect terminals "CHK" and "IGN" of the diagnostic connector for over 2 seconds then disconnect. The exhaust gas sensor output mode is switched after exhaust gas temperature warning lamp (or red lamp in control unit) flashes 2 times.</p>	<p>Indication is made by the warning lamp (exhaust gas temperature warning lamp) on the instrument panel and the red lamp on the control unit.</p> <p>1. During air-fuel ratio feedback control: OFF: when exhaust sensor output is "RICH" ON: when exhaust sensor output is "LEAN" (Reference) The lamp ON and OFF indication is the same as that of the air-fuel ratio feedback correction coefficient indicated by the red lamp in the former control unit.</p> <p>2. When air-fuel ratio feedback control is clamped: The status immediately before clamping is maintained.</p> <p>3. When air-fuel ratio feedback control is faulty: OFF</p> <p>Display example:</p>  <p>The status of the air-fuel ratio is indicated by the duty ratio in one cycle.</p> 

**(2) CONSULT DISPLAY SCREEN**

Connect CONSULT to the diagnostic connector on the vehicle (near fuse block). Data is displayed on the CONSULT screen as touch-sensitive key. The exhaust gas sensor monitor, switch ON/OFF operation and real-time diagnosis are performed using data monitor mode.

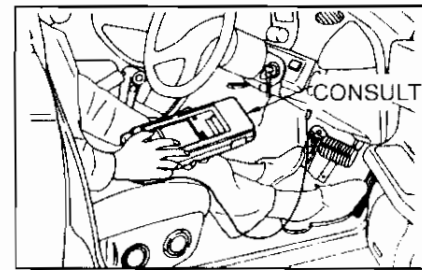
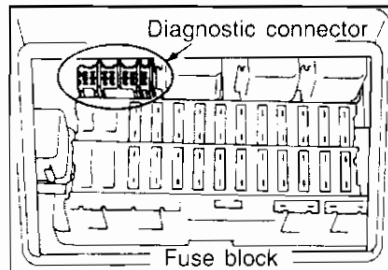

**(1) "Self-diagnostic" mode**

The diagnostic items are same as (1) (2). Faulty system name is indicated.

Steps	Operation	Display
1	Connect CONSULT to diagnostic connector of vehicle.	<div style="border: 1px solid black; padding: 5px;"> <p style="text-align: center;">◆ SELF-DIAG ◆ <input type="checkbox"/></p> <p style="text-align: center;">RESULTS</p> <p>FAILURE DETECTED TIME</p> <p>ENGINE TEMP SENSOR 0</p> <div style="display: flex; justify-content: space-around; margin-top: 10px;"> <span>ERASE</span> <span>PRINT</span> </div> </div> <p style="margin-left: 20px;">Number of times the vehicle has been driven since detecting the last problem. If same problem is still present "0" is displayed.</p>
2	Place ignition switch to ON.	
3	Inspect with "Self-diagnosis" mode.	
4	Touch "PRINT" key to print. Touch "ERASE" to erase data.	

### 2-3 FAIL-SAFE FUNCTION AND BACKUP FUNCTION

The fail-safe function ensures the safety of the driver and the vehicle by using the control unit control signals in case of an error in an important system device.

The back up function ensures normal vehicle operation when an error occurs in an important sensor. The control unit will ignore the signal sent from a failed sensor and outputs prearranged control signals.

The fault alarm mode is set when the backup function is operating and exhaust gas temperature warning lamp will flashes in the instrument panel to warn the driver.

Applicable engine			Item	Fault description	Fuel-safe or backup	Warning display
RB26-DETT	CA181i	RB20				
○	-	○	CPU backup	When detecting error in internal circuit of control unit	Fix ignition timing at specified value Fix fuel injection at start-time, idling and driving	Exhaust gas temperature warning lamp flashes in 1-sec interval Reduce speed when CPU is performed
-	-	RB20E only	Crank angle sensor backup	When crank angle sensor signal (1° or 120°) is not displayed for more than 3 seconds when engine is started	Fix ignition timing at specified value	Exhaust gas temperature warning lamp flashes in 3-sec interval ("11" is indicated in self-diagnosis mode)
○	○	○	Air flow meter	When intake air quantity signal is disconnected during engine operation	Fix ignition injection pulse width at specified value Fuel cut at 2400rpm	("12" is indicated in self-diagnosis mode)
○	-	○	Engine temperature sensor	When short-circuited or disconnected	Enables normal engine operation	("13" is indicated in self-diagnosis mode)
○	○	-	Detonation sensor	When short-circuited or disconnected	A maximum 5° engine is elayed in knock control area.	("34" is indicated in self-diagnosis mode)
○	○	○	Throttle sensor backup	When short-circuited (approx. 0.2V max) or disconnected (approx. 5V min) during engine operation	Fuel cut at 3200rpm Controlled by engine rev and the vehicle speed	Exhaust gas temperature warning lamp flashes in 1-sec interval ("43" is indicated in self-diagnosis mode)

## 2-4 DATA MONITOR

The data monitor can be utilized when performing troubleshooting or trouble diagnosis according to self-diagnosis result. CONSULT will monitor and print the ECCS control unit input and output signal data.

### (1) Monitoring items and description

Applicable engine			Monitor item	Unit	Description	Comment
RB26-DETT	CA18i	RB20E				
○	-	○	CAS. RPM (POS)	rpm	Engine rpm calculated from POS (1o) or REF (180o) signal sent from crank angle sensor	-
-	○	RB20E only	CAS. RPM (REF)			Accuracy slightly lowered at less than idle speed
○	-	○	AIR FLOW METER	V	Air flow meter output voltage	Voltage is set at approx. 0V when engine is stopped
○	○	○	ENG TEMP SEN	°C	Engine temperature value converted from engine temperature sensor voltage	If disconnection or short-circuit occurs in sensor circuit, fail-safe is activated and engine temp is fixed at a certain level.
○	○	○	EXH GAS SEN EXH GAS SEN (R)	V	Exhaust gas sensor output voltage	Sensor output is fixed at 0V when engine is stopped
○	○	○	M/R F/C MNT M/R F/C MNT (R)	(RICH / LEAN)	Air-fuel ratio of exhaust gas sensor signal during air-fuel ratio feedback control. RICH: Detects rich mixture and control is operated to reduce mixture ratio LEAN: Detects lean mixture and control is operated to increase mixture ratio	If clamp occurs, the status just before clamp occurrence is indicated.
○	○	○	CAR SPEED SEN	km / h	Value calculated from vehicle speed sensor signal	-
○	○	○	BATTERY VOLT	V	ECCS control unit power supply voltage	-
○	○	○	THROTTLE SEN	V	Throttle sensor output voltage CA18i { Throttle sensor : Signal 1 Throttle sensor (2) : Signal 2	-
-	○	-	THROTTLE SEN (2)			
○	○	-	INT / A TEMP SEN	°C	The value converted from intake temperature sensor output voltage to intake temperature	Fail safe is activated if disconnection or short-circuit occurs and set to this value.
○	○	○	START SIG	(ON / OFF)	ON / OFF setting is determined from each signal output	"OFF" is indicated irrespective of starter signal after starting engine
○	○	○	IDLE POSITION			-
○	○	○	AIR COND SIG			-
○	○	○	NEUTRAL SIG			-
○	○	○	PW/ST SIGNAL			-
-	○	-	ELECT FAULT SIG			-
○	○	○	INJ PULSE	msec	Value computed by control unit	A value is indicated with engine stopped
○	○	○	IGN TIMING	BTDC (°)	Value is computed by control unit	-
-	-	○	AAC VALVE	%	Value computed by control unit "% "proportional solenoid system	A fixed value is indicated with engine stopped
○	○	○	A / F ALPHA A / F ALPHA (R)		Mean value of air-fuel ratio feedback correction factor for each cycle	-
○	○	○	AIR COND RELAY	(ON / OFF)	Control condition computed by control unit	-
○	○	○	FUEL PUMP RELAY			
-	○	-	W / G CONT S / V	(ON / OFF)	Control condition controlled by control unit	ON: Correction passage "open"
-	○	-	FICD S / V			OFF: Correction passage "closed"
-	○	-	PTC HEATER			-

(2) Operation and display

STEP	OPERATION	DISPLAY (Example)
1	Connect CONSULT to diagnostic connector on vehicle.	<div style="border: 1px solid black; padding: 5px;">                     ☆MONITOR☆NO FAIL <input type="checkbox"/>                      CAS. RPM (POS) 687rpm                      AIR FLOW MTR 1.08V                      ENG TEMP SEN 70°C                      EXH GAS SEN 0.30V                      EXH GAS SEN MON LEAN                      CAR SPEED SEN 0km/h  <hr/>                     RECORD                 </div>
2	Run the engine or drive the vehicle.	
3	Select desired item on "DATA MONITOR".	
4	Press RECORD" key.	<div style="border: 1px solid black; padding: 5px;">                     ★MONITOR★ NO FAIL <input type="checkbox"/>                      CAS. RPM (POS) 685rpm                      AIR FLOW MTR 1.06V                      ENG TEMP SEN 80°C                      EXH GAS SEN 0.35V                      EXH GAS SEN MON LEAN                      CAR SPEED SEN 0km/h                      BATTERY VOLT 13.8V  <hr/>                     RECORD                 </div>

(1) Exhaust gas sensor monitor

Exhaust gas sensor output voltage and RICH / LEAN status are displayed.

STEP	OPERATION	DISPLAY (Example)
1	Connect CONSULT to diagnostic connector on vehicle.	<div style="border: 1px solid black; padding: 5px;">                     ☆MONITOR☆NO FAIL <input type="checkbox"/>                      EXH GAS SEN 0.18V                      EXH GAS SEN MON RICH  <hr/>                     RECORD                 </div>
2	Run the engine.	
3	Select EXH GAS SEN, EXH GAS SEN-R, M/R F/C MNT and M/R F/C MNT-R items on "DATA MONITOR".	
4	Press RECORD" key.	

(2) Switch ON / OFF.

The ON / OFF status of each switch is indicated.

STEP	OPERATION	DISPLAY (Example)
1	Connect CONSULT to diagnostic connector on vehicle.	<div style="border: 1px solid black; padding: 5px;">                     ☆MONITOR☆NO FAIL <input type="checkbox"/>                      IDLE SW ON                      AIR CON SIG OFF                      NEUTRAL SW ON                      PW/ST SIGNAL OFF  <hr/>                     RECORD                 </div>
2	Run the engine or drive the vehicle.	
3	Select each switch "DATA MONITOR".	
4	Set operating condition for applicable switch and check ON / OFF display.	

**Diagnosis item**

- (1) Ignition switch START signal system
- (2) Throttle valve switch (idling connection) signal system
- (3) Neutral switch signal system
- (4) Power steering switch signal system
- (5) Electric load signal system (CA18i)

## (3) Real-time diagnosis

Although the diagnosis items are same as those listed in **2-2 (1)** (2) self-diagnosis, and switch ON/OFF in section **2-2**, this diagnostic mode provides higher detection capability than the self-diagnosis mode (2). But it doesn't diagnose intake temperature sensor signal system for CA18i.

STEP	OPERATION	DISPLAY (Example)
1	Connect CONSULT to diagnostic connector on the vehicle.	◆ REAL-TIME DIAG ◆ <input type="checkbox"/> ENGINE TEMP SENSOR
2	Run the engine or drive the vehicle.	
3	Select desired items on "ACTIVE TEST" menu.	DATA RECORD (MEMORY 1)
4	Press "START" key and input set value.	MEMORY DATA DISPLAY

**2-5 ACTIVE TEST**

The active test mode is utilized to examine the problem diagnosis according to self-diagnosis results and data monitor results. CONSULT will give driving signals to the actuators while isolating the on-board ECCS control unit, to check if the actuator is functioning normally.

**(1) Test items and description**

Some test items may not apply to all vehicle modes.

Active test items	Description	Applicable engine		
		CA18i	RB20	RB26DETT
Fuel-injection	Changes air-fuel ratio	○	○	○
AAC valve opening	Sets control value (opening)	-	○	○
Engine teperature	Sets engine temperature	○	○	○
Ignition timing	Sets delay angle correction value	○	○	○
Idle correction S / V	Turns ON / OFF	○	-	-
FICD S / V		○	-	-
Fuel pump relay		○	○	○
Self - learning cont	Clears learned data on air-fuel ratio feedback correction factor	○	○	○

**(2) Operation and display**

STEP	OPERATION	DISPLAY (Example)
1	Connect CONSULT to diagnostic connector on the vehicle.	<div style="border: 1px solid black; padding: 5px;"> <p>◆ ACTIVE TEST ◆ <input type="checkbox"/></p> <p>ENGINE TEMP     -2°C     Setting value</p> <p>CAS.RPM (POS) 112rpm</p> <p>INJ PULSE       7.3 msec     Data monitor</p> <p>IGN TIMING      25BTDC</p> <p>Setting value increase and decrease keys.</p> <p>Qu    UP    DWN    Qd</p> </div>
2	Run the engine or drive the vehicle.	
3	Select desired items on "ACTIVE TEST" menu.	
4	Press "START" key and input set value.	



**2-6 OPERATION SUPPORT**

CONSULT can be used as an aid for idling checks and other engine tune-up operations. It issues instructions to the ECCS control unit to perform control and displays the input and output signal data being used. Actual tune-up operations must be performed manually by the mechanic (for example, turning adjustment screw etc).

**(1) Support items and description**

Operation support item	Description	Applicable engines		
		CA181	RB20	RB20DETT
Idle rev adj	Fully closing idle rev correction solenoid and displays idle rpm speed	○	-	-
AAC valve adj	Fully close AAC valve and displays idle rpm	-	○	○
Idle SW adj	Displays engine rpm when idle contact point changes from OFF to ON by fully closing AAC valve	-	○	-
Ignition timing adj	Fix ignition timing feedback control and displays ignition timing	○	-	-
Throttle sensor adj	Fully closes throttle valve and displays throttle sensor output voltage	○	-	○
Fuel pressure release	Stops fuel pump operation and stall the engine (crank the pedal to release fuel pressure within the fuel piping)	○	RB20E	-

**(2) Operation and display**

STEP	OPERATION	DISPLAY (Example)
1	Connect CONSULT to diagnostic connector on vehicle.	<div style="border: 1px solid black; padding: 5px;"> <p style="text-align: center;">◆IGN TIMING ADJ◆</p> <p>PRESS "START" WHEN IDLING AND STOP IGNITION TIMING FEEDBACK CONTROL. ROTATE CRANK ANGLE SENSOR AND USE TIMING LIGHT TO ADJUST</p> <hr/> <p style="text-align: center;">START</p> <hr/> <p style="text-align: center;">◆IGN TIMING ADJ◆ <input type="checkbox"/></p> <p>IGNITION TIMING FEEDBACK FIXED</p> <p>CAS. RPM (REF) 575rpm IGN TIMING 12BTDC IDLE POSITION ON</p> </div>
2	Run the engine.	
3	Select desired item on "WORK SUPPORT" menu.	
4	Press "START" key and execute operation.	

### 3 BASIC INSPECTION

Inspect three elements of combustion (1. Is fuel injected? 2. Does the spark ark? 3. Does the AAC valve work correctly?) and determine if the faulty system is the fuel system, ignition system or idle control system.

#### 3-1 Injector operation inspection

- Check for injector operation noise (click, click, click) while cranking the engine by placing stethoscope or s crewdriver on the injector.

IF NG: Inspect injector control circuit.

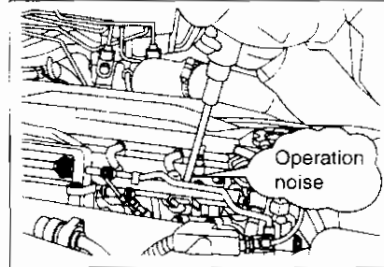

#### 3-2 Fuel pump inspection

- Connect CONSULT to the diagnosis terminal on the vehicle side (near the fuse block).

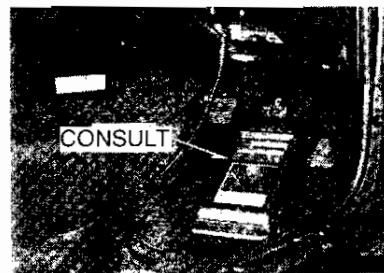

- Turn the ignition switch "ON" and select the "ACTIVE TEST" mode. Press "Fuel pump relay" and check for pump operation noise.

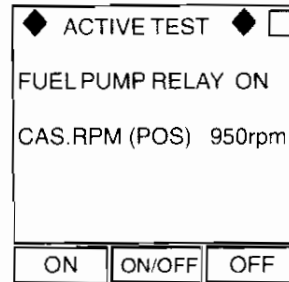

- Check for fuel pump operation noise for five second after turning ignition switch to "ON" position.
- There must be a fuel pump operation noise when cranking.

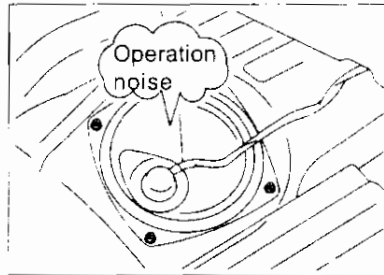

IF NG: Inspect fuel pump control circuit.

#### 3-3 Fuel pressure inspection

##### (1) Simple inspection

- Pinch the hose between fuel filter and fuel gallery when the fuel pump is operating. There must be tension and pulsations in the hose.

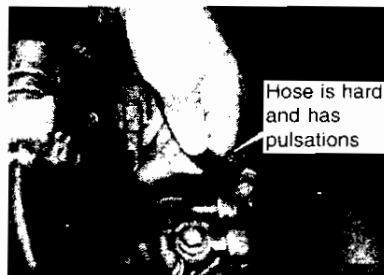

- Run the engine.
- Select "FUEL PUMP RELAY" in the "ACTIVE TEST" mode.
- Press OFF switch to release fuel pressure.

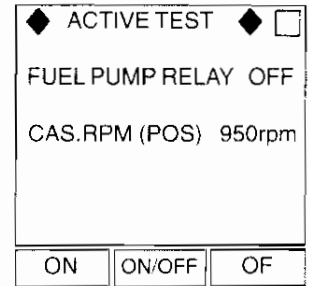

**(2) Inspection using fuel pressure gauge**

**Fuel pressure release**

- Remove the fuel pump fuse after starting the engine. Crank the engine 2 ~ 3 times to consume all fuel in the fuel lines.
- When engine will not start, remove pump fuse and crank engine 4 ~ 5 time to consume all fuel in the fuel lines.

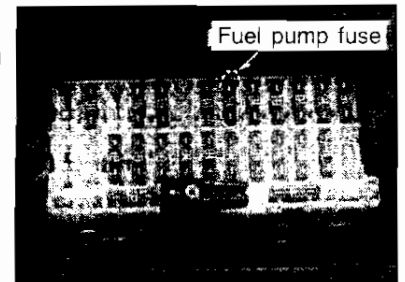

Caution:

Use booster cables to connect it to another vehicle or charged battery if the battery become weak.

**Fuel pressure gauge installation**

- Connect the fuel pressure gauge between the fuel strainer and the fuel gallery.
- Install fuel pump fuse.
- Start the engine and check if the fuel pressure reaches standard value.

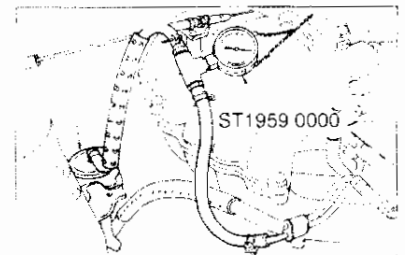

**Fuel pressure inspection**

Condition	RB20DE, DET, 26DETT	RB20E	CA18i
Idling (kg/cm <sup>2</sup> )	Approx. 2.5	Approx. 2.0	Approx. 1.0
When pressure regulator vacuum hose is removed (kg/cm <sup>2</sup> )	Approx. 3.0	Approx. 3.0	Approx. 1.0

- For the vehicle with starting problems, turn ignition switch ON and check fuel pressure for 5 seconds when fuel pump is rotating.

Condition	RB20DE, DET, RB26DETT	RB20E	CA18i
Ignition switch "ON" for 5 seconds (kg/cm <sup>2</sup> )	Approx. 3.0	Approx. 2.5	Approx. 1.0



IF NG:

- |                                   |  |
|-----------------------------------|--|
| Fuel pressure is abnormally high: | Pressure regulator is faulty.<br>Return system is clogged or hose is bent.                     |
| Fuel pressure is abnormally low:  | Pressure regulator is faulty.<br>Fuel pump output is faulty.<br>Fuel supply system is clogged. |

Note:

Fuel pressure should also be checked when the engine speed is increased.

**3-4 Spark inspection**

**(1) In case of SOHC**

- Disconnect one of the high tension cables connected to the spark plug and connect it to spark plug unit. Bring spark plug closer to engine main body (disconnect ground cable) and crank the engine to see if the spark arcs (check with every cylinder).
- If it doesn't spark with any of the cylinders, install spark plug to the centre cable and carry out the spark inspection. If the spark arcs there is a possibility of fault with the distributor system.

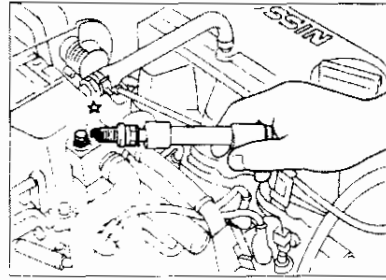

**(2) In case of DOHC**

- Measure the voltage with a test probe at power transistor coil side terminal for spark signal of the primary system.

**Terminal 1 ~ 6 when cranking engine Approx. 9.5V**

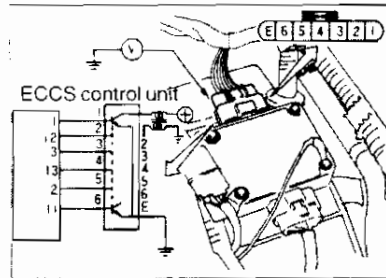

- Primary system check can also be performed by timing light or tachometer needle deflection.
- To check if sparks actually arc or not, remove ignition coil (No. 1 cylinder is easiest). Connect spark plug and place it against collector or other part for ground. Check if spark arcs when engine is cranked.

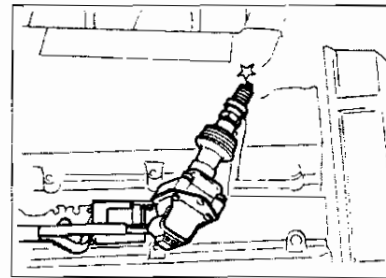

IF NG: Inspect ignition control system.

**3-5 AAC valve operation inspection**

- Start the engine.
- Set any angle in the "AAC valve opening" items in "ACTIVE TEST" mode.
- Check if idle speed at this time varies from set value.



◆	ACTIVE TEST	◆	<input type="checkbox"/>
AAC / V OPENING 16%			
MONITOR			
CAS.RPM (POS) 950rpm			
AIR FLOW METER 0.93V			
AIR FLOW METER(R)0.88V			
ENG TEMP SEN 87°C			
Qu	UP	DWN	Qd

- After warming up the engine check if idle speed lowers from specified value when AAC valve connectors are removed.

**RB26DETT**

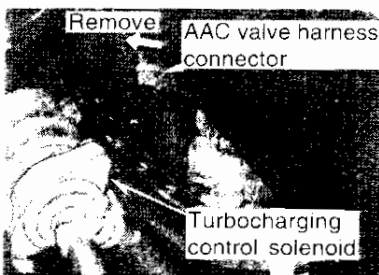

**RB20 (SOHC)**

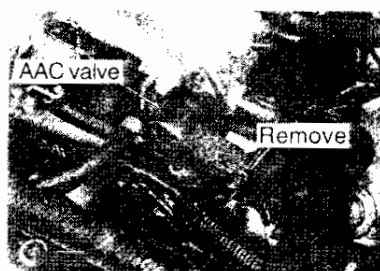

**RB20 (DOHC)**

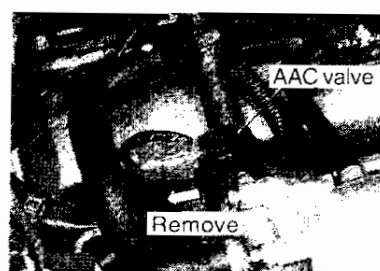

**3-6 Air regulator operation inspection**

- Start the engine when cold and check if the idle speed lowers when air regulator hose is closed or partially pressed.
- Start the engine when cold and check if specified idle speed will increase after AAC valve connector is removed and engine warms up.
- Connect AAC valve connector and warm up the engine sufficiently.
- After warming up the engine remove AAC valve connector again and check if idling

**RB26DETT**

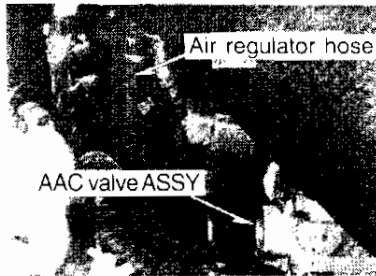

**RB20 (SOHC)**

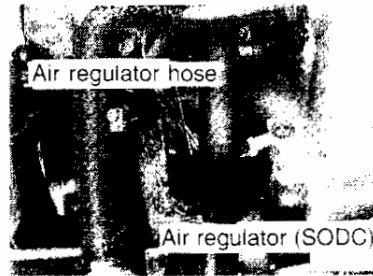

**RB20 (DOHC)**

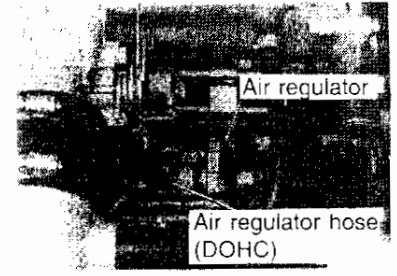

**3-7 Intake manifold vacuum**

- Inspect the vacuum when idling after warming up the engine.

Engine	Vacuum
RB26DETT, RB20DET	Approx. -480mmHg
RB20E, DE	Approx. 1510 mmHg
CA18i	-500 ~ - 550 mmHg



- The vacuum value will be abnormal if there are air leaks or other problems with combustion or main engine body. Locate and correct the cause of problem.

### 3 BASIC INSPECTION

1

**Before engine start**

- Look for fault indication and check recent service record.
- Check the following in the engine bay
  - Is harness connector connected correctly?
  - Is there any cracks or torsion on vacuum hose? connected correctly?
  - Is harness connected correctly with no disconnection.

2

**Connect CONSULT**

Connect diagnosis connector to CONSULT and place ignition switch to ON position. Select "ENGINE" from the item menu.

1

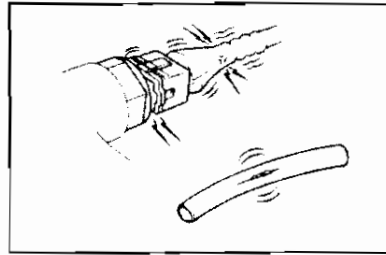

2

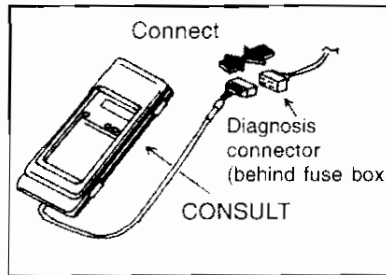

3

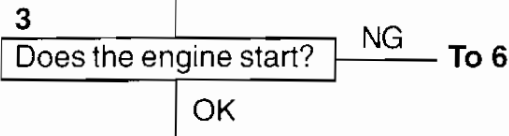
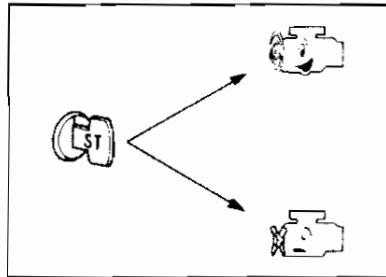

4

**Idle adjustment screw primary stage set up revolution inspection**

- Select "AAC valve adjustment" mode in "OPERATION SUPPORT".
- Check that engine rpm will drop to 600 ~ 700 rpm when "START" is pressed (N range).
- Check that engine rpm will drop to 600 ~ 700 rpm when ECCS C / U adjustment volume is turned right until it stops.

4

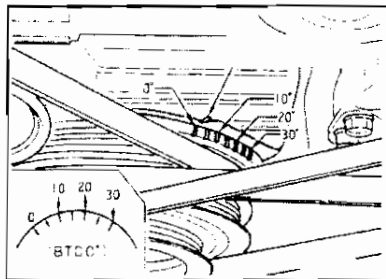

4

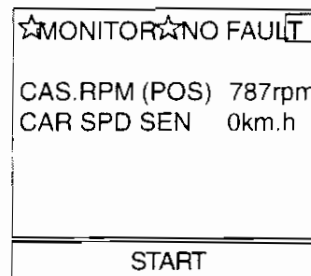

OK **To 5**

For engine rpm adjustment use idle adjustment screw.

5

**Ignition timing inspection**  
 After warming up the engine, idle the engine and inspect the ignition timing using timing light. For more information refer to "Idle rev, ignition timing, air-fuel ratio inspection" section earlier in the manual.  
**Ignition timing (BTDC°) : 13 ~ 17°**

NG

OK

Rotate crank angle sensor to adjust ignition timing.

6

**Throttle sensor idle position inspection**

- Select "THROTTLE SENSOR ADJ" from operation support mode.
- Check that throttle sensor output voltage is approx. 0.4 ~ 0.5V (fully closed) and Idle position is ON.
- Use voltmeter to measure throttle sensor output voltage. Make sure it is between approx. 0.4 ~ 0.5V (fully closed).

5

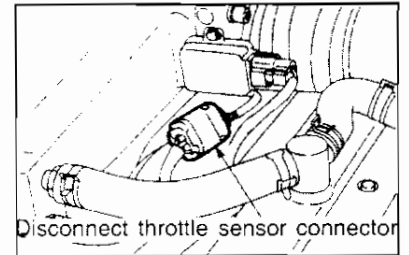

6

◆ THROTTLE ADJ ◆ □  
 ADJ MONITOR  
 THROTTLE SENS 0.40V  
 MONITOR  
 CAS.RPM (REF) 0rpm  
 IDLE ON

7

**Switches input signal inspection**  
 Select following switches in "DATA MONITOR" mode.

- Start signal
- Idling
- A/C signal
- Neutral SW
- PWR/ST signal

Disconnect ECCS C/U and use voltmeter to inspect switch ON/OFF operations.

Switch	Condition	Voltage (V)
Start signal	Ignition SW on Ignition SW start	0 Power supply voltage
Idling	Idling after warm up accelerator depressed	Power supply voltage 0
A/C signal	A/C off A/C on	7.0 - 10.0 0.5 - 0.7
Neutral SW	N, P range N, other than P	0 8.0 - 10.0
PWR/ST sig	PWR/ST off PWR/ST on	8 0

6

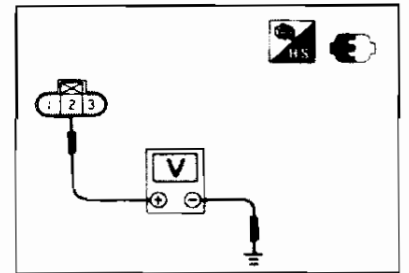

7

MONITOR NO FAULT  
 STARTER SIG OFF  
 IDLE ON  
 A/C SIG OFF  
 NEUTRAL SIG ON  
 P/S SIG OFF  
 START

7

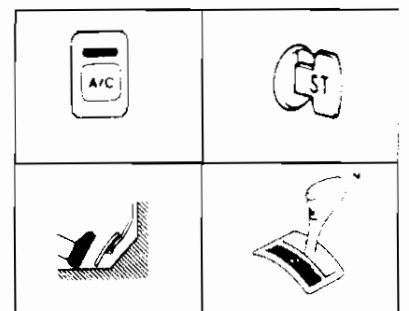

OK 8

8

**Self-diagnosis result confirmation**

- Operate "SELF-DIAGNOSIS RESULT" mode.
- Confirm self-diagnosis results.
- Is there any problem?

NG

- Set to "SELF-DIAGNOSIS MODE 2".
- Check the code number by exhaust gas temperature warning lamp or ECCS C/U red lamp.
- Is there any problem?

OK

Carry out applicable procedure

8

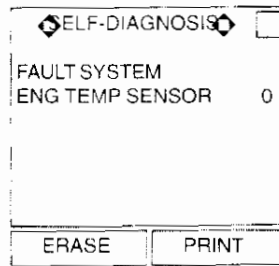

8

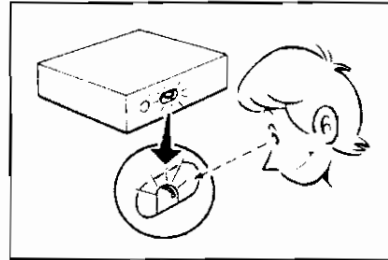

9

**Injector operation inspection**

Place a stethoscope or screwdriver on the injector and check for injector operation noise (click, click, click) while cranking engine.

NG

OK

Check injector control circuit

9

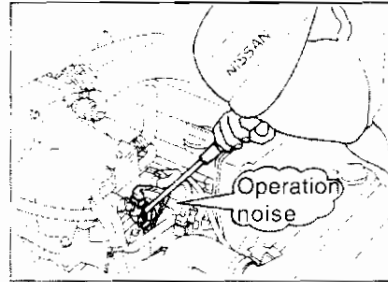

10

**Fuel pump operation inspection**

- Inspect by "FUEL PUMP" in "FUNCTION TEST" mode or "FUEL PUMP RELAY" in "ACTIVE TEST" mode. Check if you can hear fuel pump operation noise when "OPERATE" is pressed. 

NG

- After turning ignition switch "ON", check for fuel pump operation noise for 5 seconds. 

OK

Check fuel pump control circuit

10

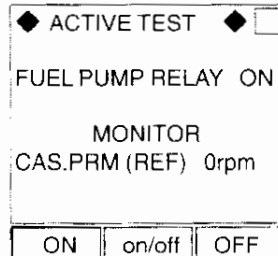

10

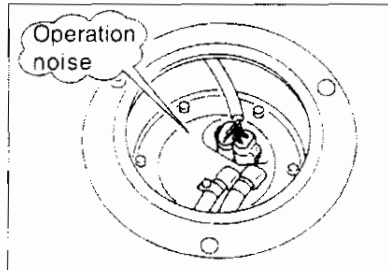

11

**Fuel pressure inspection**

When the fuel pump is operating, press the hose between fuel filter and fuel gallery with a finger. There must be tension and pulsations in the hose.

NG

OK

Check fuel supply system for clog, twist or bend.

11

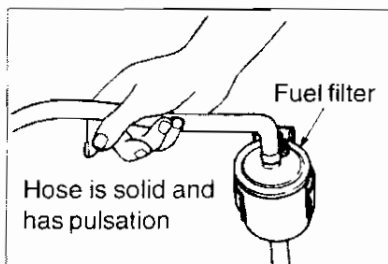

Finish



## 4 SYSTEM FIGURE & CIRCUIT DIAGRAM

### Wireless equipment

- When installing CB ham radio or a mobile phone, make sure to observe the following points as it may affect electronic control system depending on its installation position.
1. Keep the antenna as far as possible away from control unit.
  2. Keep the antenna feeder line more than 20 cm away from the control unit harness.
  3. Adjust the antenna and feeder line, so that the standing wave ratio can be kept small.
  4. Make sure to ground the radio to vehicle body.

### Control unit

- Do not disassemble control unit.
- Do not turn diagnosis mode selector switch forcibly.
- If a battery terminal is disconnected, the memory will return to the initial setting value.

### Battery

- Only use 12V battery as power source.
- Do not disconnect battery cables while engine is running.
- Do not disconnect injector harness connector while engine is running.



### ECCS parts handling

- Air flow meter must be handled with care to avoid damages.
- Do not clean air flow meter with any type of detergent.
- Slight leak in the air intake system can cause serious problem.
- Do not apply shock to crank angle sensor.

### Fuel pump

- Do not operate fuel pump when there is no fuel in lines.
- Make sure to tighten fuel hose clamps to the specified torque.

### Control unit harness handling

- Securely connect ECM harness connectors.
- Poor connections can cause an extremely high (surge) voltage to develop in coil and condenser.
- Keep ECM harness at least 10cm away from adjacent harnesses to prevent ECM system malfunction due to receiving external noise, degraded operation of ICs, etc.
- Make sure to place ignition switch in "OFF" position and then disconnect battery ground cable.

### When starting

- Do not depress acceleration pedal when starting.
- Do not rev up engine unnecessarily immediately after starting engine.
- Do not rev up engine just prior to shutdown.

SYSTEM FIGURE & CIRCUIT DIAGRAM

RB26DETT ENGINE

4-1 SYSTEM FIGURE (RB26DETT ENGINE)

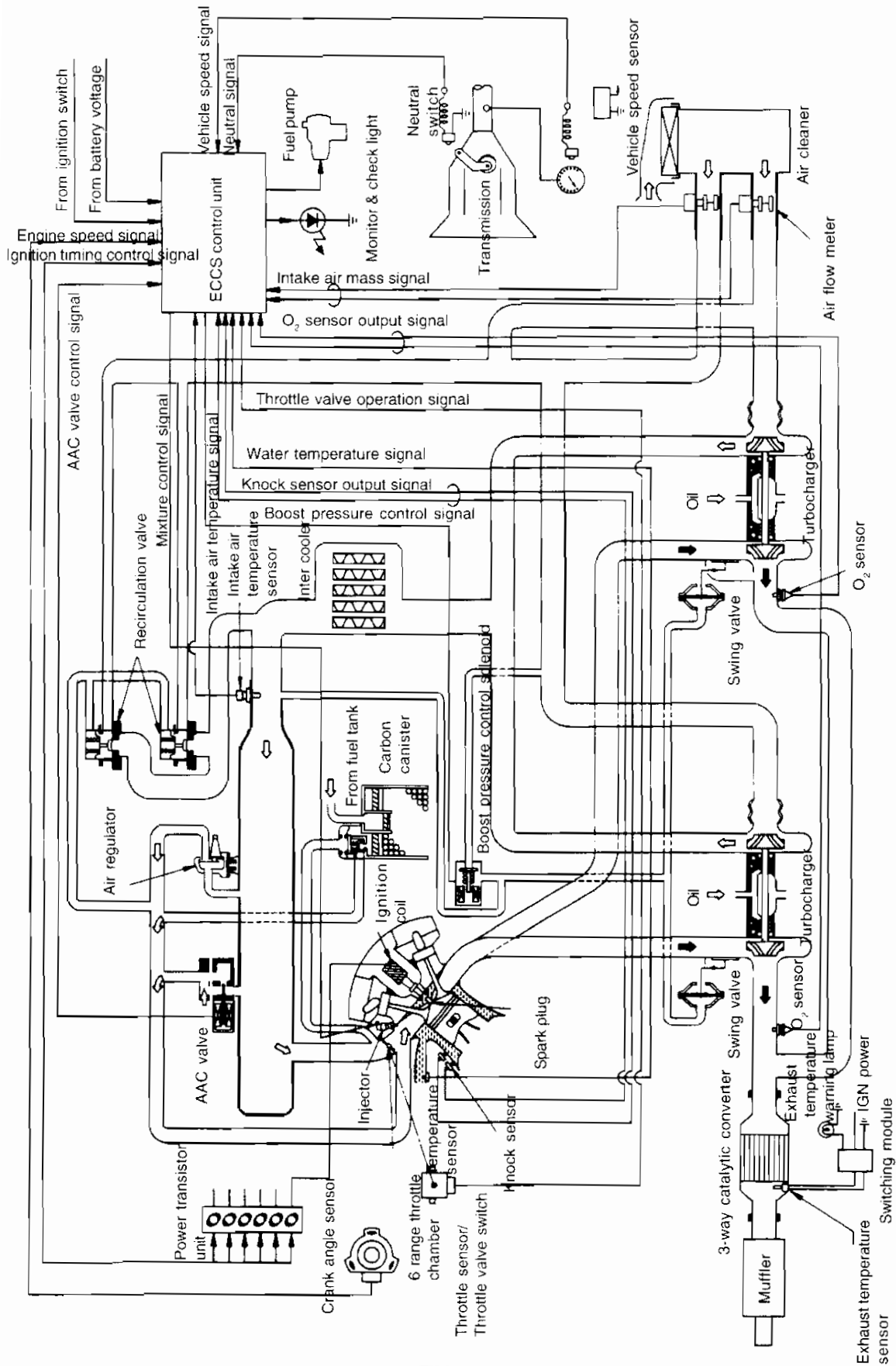

4-2 CIRCUIT DIAGRAM (RB26DETT ENGINE)

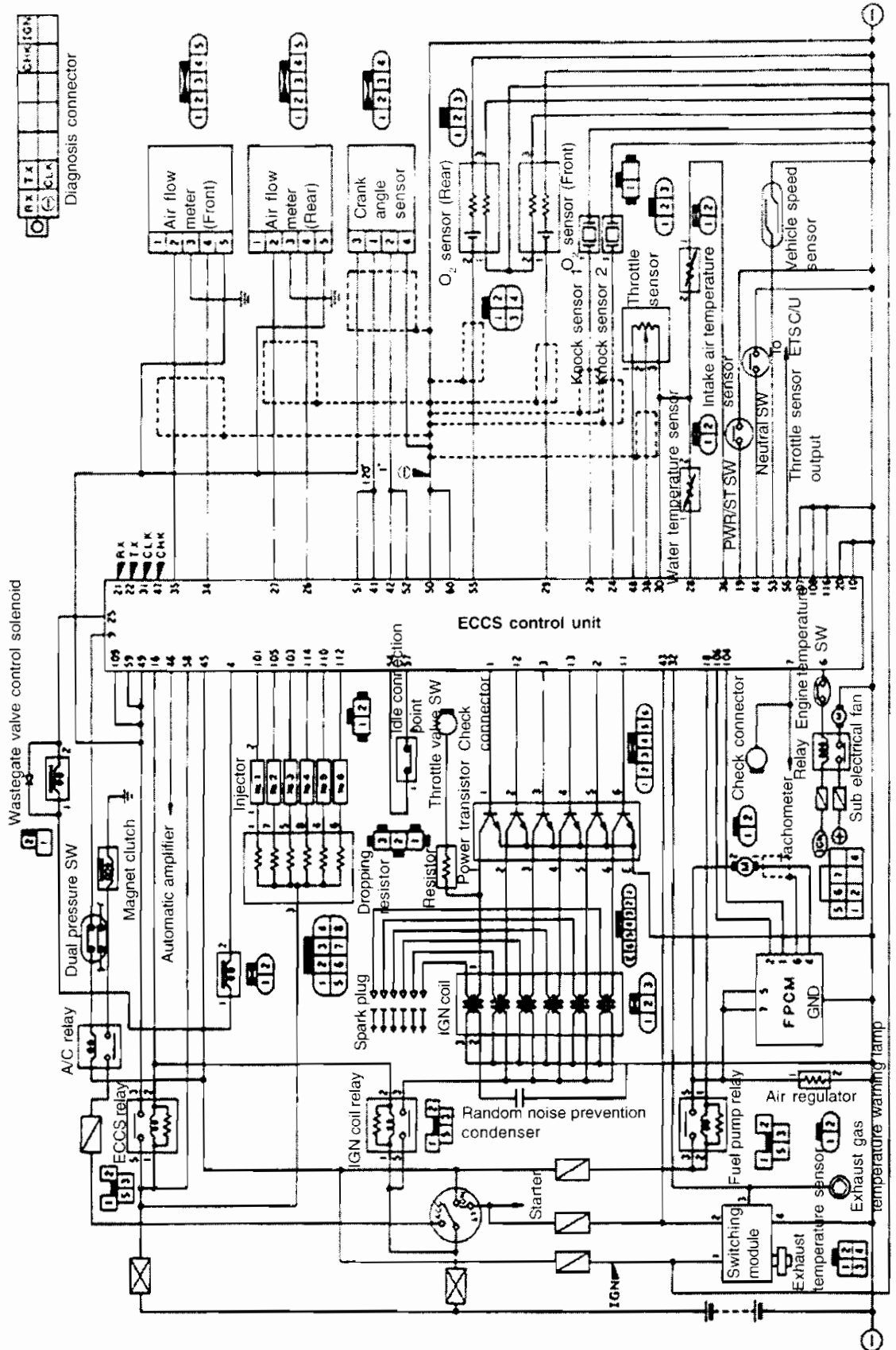

SYSTEM FIGURE & CIRCUIT DIAGRAM

RB26DETT ENGINE

ECCS CONTROL UNIT PIN LAYOUT FIGURE (RB26DETT ENGINE)

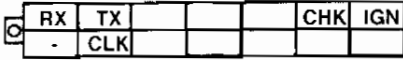
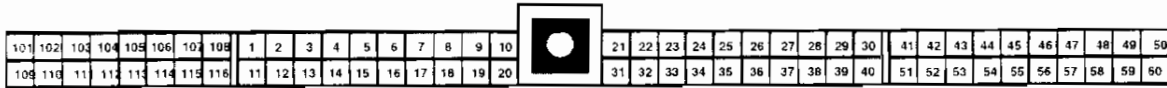

Terminal No.	Description	Terminal No.	Description
1	Ignition timing (Power transistor) Cyl. No.1	11	Ignition timing (Power transistor) Cyl. No.6
2	Ignition timing (Power transistor) Cyl. No.5	12	Ignition timing (Power transistor) Cyl. No.2
3	Ignition timing (Power transistor) Cyl. No.3	13	Ignition timing (Power transistor) Cyl. No.4
4	AAC valve	14	-
5	-	15	-
6	Sub electrical fan relay (engine temp SW)	16	ECCS relay
7	Tachometer speed signal	17	-
8	-	18	Fuel pump relay
9	Air conditioner relay (A / C cut signal)	19	Power steering oil pressure switch
10	Ground (ignition signal system)	20	Ground (ignition signal system)
21 (RX)	Recieve (control unit data reception)	31 (CLK)	Clock (synchronization signal)
22 (TX)	Transmit (data sent from control unit)	32	Monitor and check lamp (red)
23	Detonation sensor 1 (cyl 1 ~ 3)	33	-
24	Detonation sensor 1 (cyl 4 ~ 6)	34	Air flow meter ground
25	Wastegate valve control solenoid valve	35	Air flow meter intake air signal (front)
26	Air flow meter ground	36	Intake air temperature sensor
27	Air flow meter intake air signal (rear)	37	-
28	Engine temperature sensor	38	Throttle opening output
29	Exhaust gas sensor	39	-
30	Sensor ground (throttle sen. EGN temp)	40	-
41	Crank angle sensor (120° signal)	51	Crank angle sensor (120° signal)
42	Crank angle sensor (1° signal)	52	Crank angle sensor (1° signal)
43	Ignition switch START signal	53	Vehicle speed sensor
44	Neutral switch	54	Throttle valve switch (Idle connection PT)
45 (IGN)	Ignition switch (IGN)	55	Exhaust gas sensor (rear)
46	Air conditioner switch	56	Throttle sensor output signal
47 (CHK)	Check (Diagnosis activation)	57	Throttle valve switch power supply
48	Throttle sensor power supply	58	Battery power supply
49	Control unit power supply	59	Control unit power supply
50	Ground (Control unit)	60 ( - )	Ground (control unit)
101	Injector No.1	109	Injector power supply
102	-	110	Injector No.5
103	Injector No.3	111	-
104	Fuel pump ternimal volt control output (FPCM) 1	112	Injector No.6
105	Injector No.2	113	-
106	Fuel pump ternimal volt control output (FPCM) 2	114	Injector No.4
107	Injector ground	115	-
108	Injector ground	116	Injector ground

**ECCS COMPONENT PARTS (RB26DETT ENGINE)**

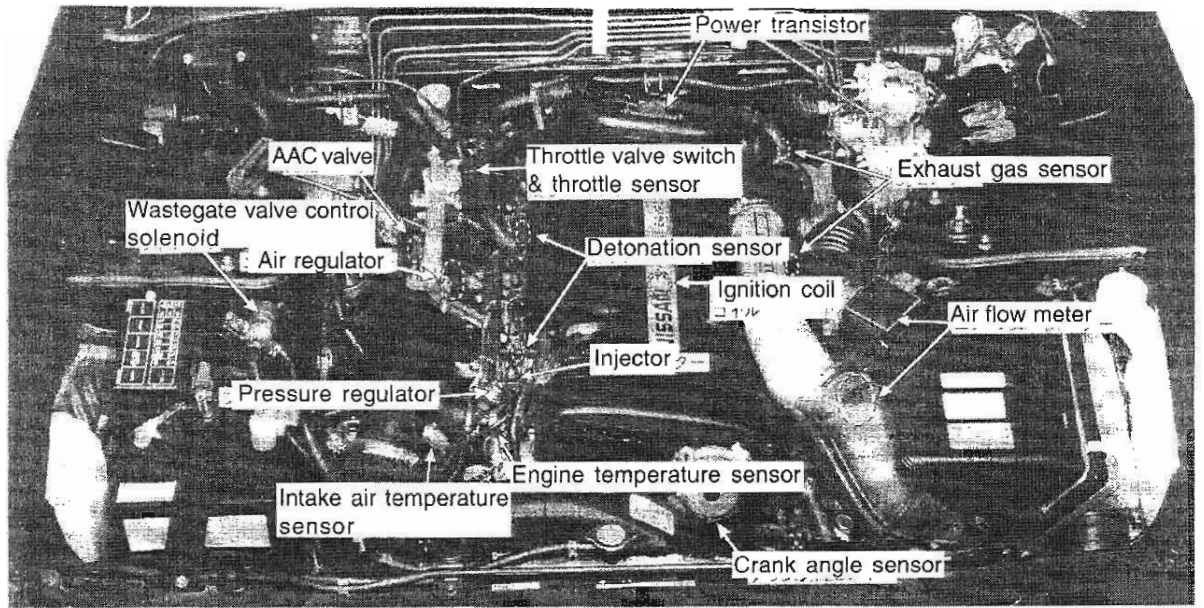

	Component part	Type	Installation position
<b>Actuator system</b>	Wastegate control solenoid	Solenoid type	Strut tower right
	Pressure regulator	Diaphragm system	Fuel pipe front end
	Injector	Top feed type	Intake manifold
	Fuel pump	Roller vane type	Fuel tank
	air regulator	Bi-metal type	Intake manifold lower part
	AAC valve	Solenoid type	Intake manifold collector lower part
	Ignition coil	Mino mold type	Cylinder head (above each plug)
<b>Sensor system</b>	Crank angle sensor	Photocell (camshaft drive)	Cylinder head left front
	Air flow meter (2)	Hot wire type	Front left
	Intake air temperature sensor	Thermistor type	Intake manifold collector
	Throttle sensor	Variable resistor type	Accelerator work unit
	Throttle valve switch	ON / OFF switch	Accelerator work unit
	Engine temperature sensor	Thermistor type	Water outlet
	Exhaust gas sensor	Herter attached (titanium)	Front & rear exhaust outlets
	Detonation sensor	Pressure-electrical type	Cylinder block
Fuel pump modulator	Operation amplifier	Rear pillar inner	



4-2 CIRCUIT DIAGRAM (RB20E ENGINE)

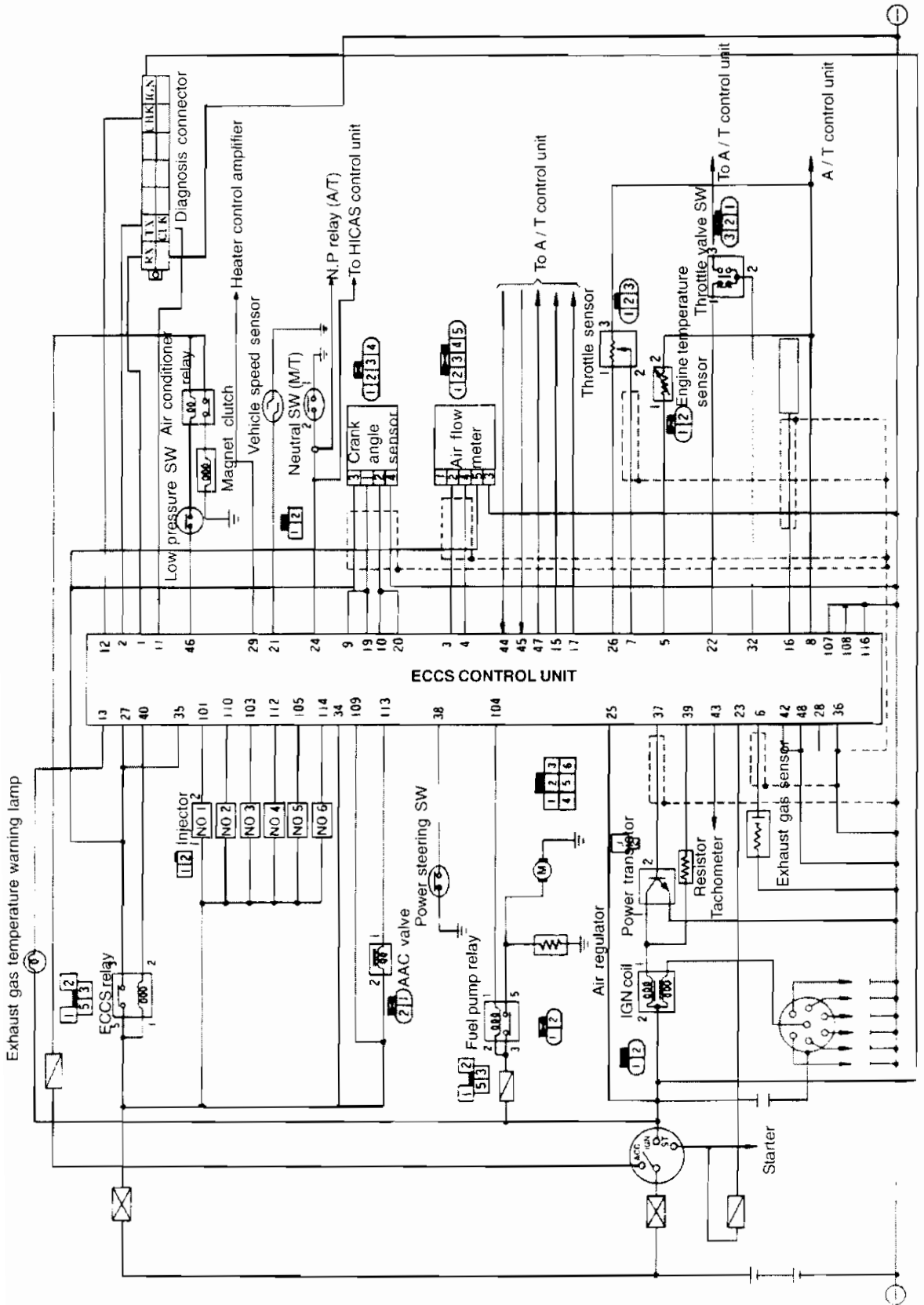

SYSTEM FIGURE & CIRCUIT DIAGRAM

RB20E ENGINE

ECCS CONTROL UNIT PIN LAYOUT FIGURE (RB20E ENGINE)

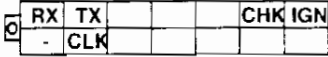
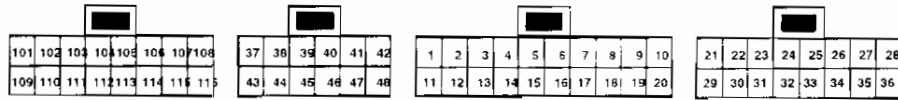

Terminal No.	Description	Terminal No.	Description
1 (RX)	Recieve (control unit data reception)	11 (CLK)	Clock (synchronization signal)
2 (TX)	Transmit (data sent from control unit)	12 (CHK)	Check (diagnosis activation)
3	Air flow meter intake air signal	13	Monitor and check lamp (red)
4	Sensor ground (Air flow meter)	14	-
5	Engine temperature sensor	15	Intake air quantity signal (to A/T C/U)
6	Exhaust gas sensor	16	Detonation sensor
7	Throttle sensor (input signal)	17	Throttle opening output signal (to A/T C/U)
8	Sensor ground (thottle sensor, Engine temperature sensor)	18	-
9	Crank angle sensor (120° signal)	19	Crank angle sensor (120° signal)
10	Crank angle sensor (1° signal)	20	Crank angle sensor (1° signal)
21	Vehicle speed sensor	29	Air conditioner switch
22	Throttle valve switch (idle connectio point)	30	-
23	Ignition switch (START signal)	31	-
24	Neutral switch	32	Throttle valve switch (power supply)
25 (IGN)	Ignition switch (IGN)	33	-
26	Throttle sensor power supply	34	Battery power supply
27	Control unit power supply	35	Control unit power supply
28	Control unit ground	36 ( - )	Control unit ground
37	Ignition signal (power transistor)	43	Tachometer speed signal
38	Power steering switch	44	Engine A/T control input signal
39	Ignition signal check	45	Engine A/T control input signal
40	ECCS relay	46	Air conditioner relay (A/C cut signal)
41	-	47	Engine A/T control output signal
42	Ground (ignition signal system)	48	Ground (ignition signal system)
101	Injector No.1	109	Injector power supply
102	-	110	Injector No.2
103	Injector No.3	111	-
104	Fuel pump relay	112	Injector No.4
105	Injector No.5	113	AAC valve
106	-	114	Injector No.6
107	Injector ground	115	-
108	Injector ground	116	Injector ground



**ECCS COMPONENT PARTS (RB20E ENGINE)**

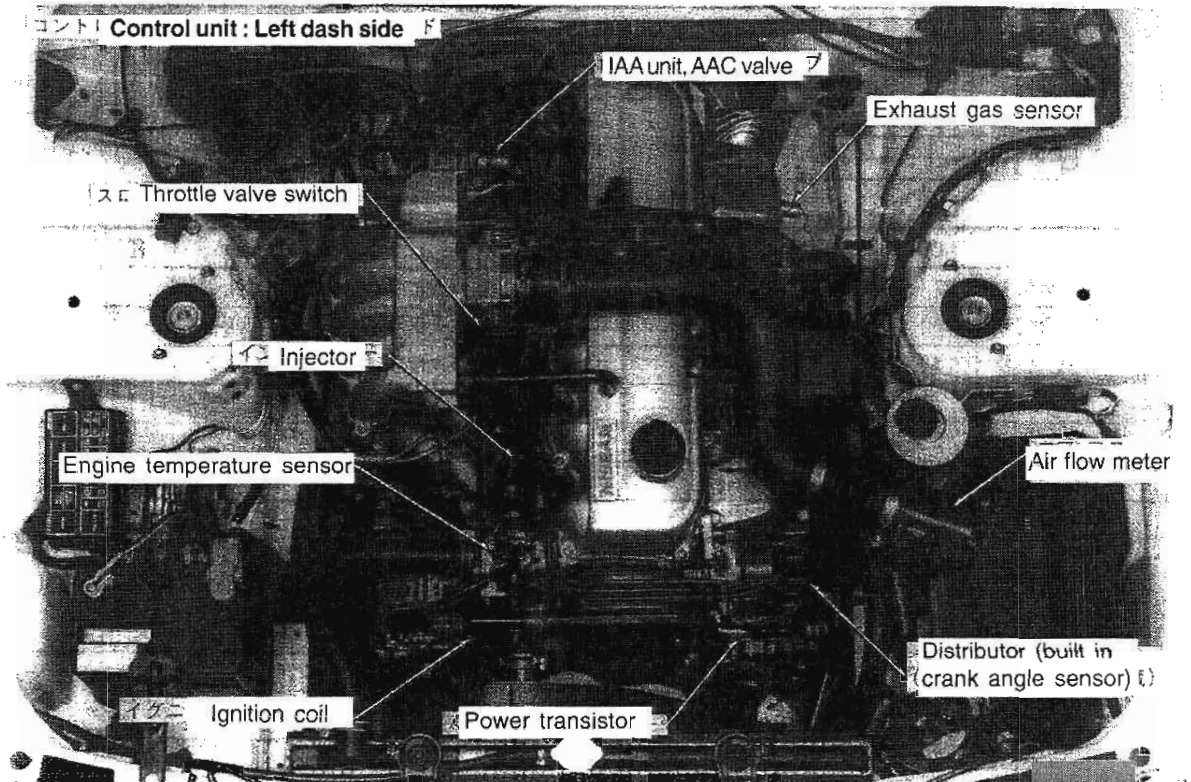

	Component part	Type	Installation position
<b>Actuator system</b>	Injector	Elevation resistor type	Intake manifold
	Fuel pump	Electronic, turbine type	Fuel tank
	AAC valve	Solenoid type	Collector
	Ignition coil	Mold type	Water outlet front part
	Power transistor unit	1-channel type	Distributor housing
<b>Sensor system</b>	Crank angle sensor	Photocell type	Built in distributor
	Air flow meter	Hot wire type	Front left
	Throttle sensor	Variable resistor type	Throttle chamber
	Throttle valve switch	Switch	Throttle chamber
	Engine temperature sensor	Thermistor type	Water outlet
	Exhaust gas sensor	Zirconium type (no heater)	Exhaust manifold
	Detonation sensor	Pressure-electrical type	Cylinder block right side

# SYSTEM FIGURE & CIRCUIT DIAGRAM

RB20DE ENGINE

## 4-1 SYSTEM FIGURE (RB20DE ENGINE)

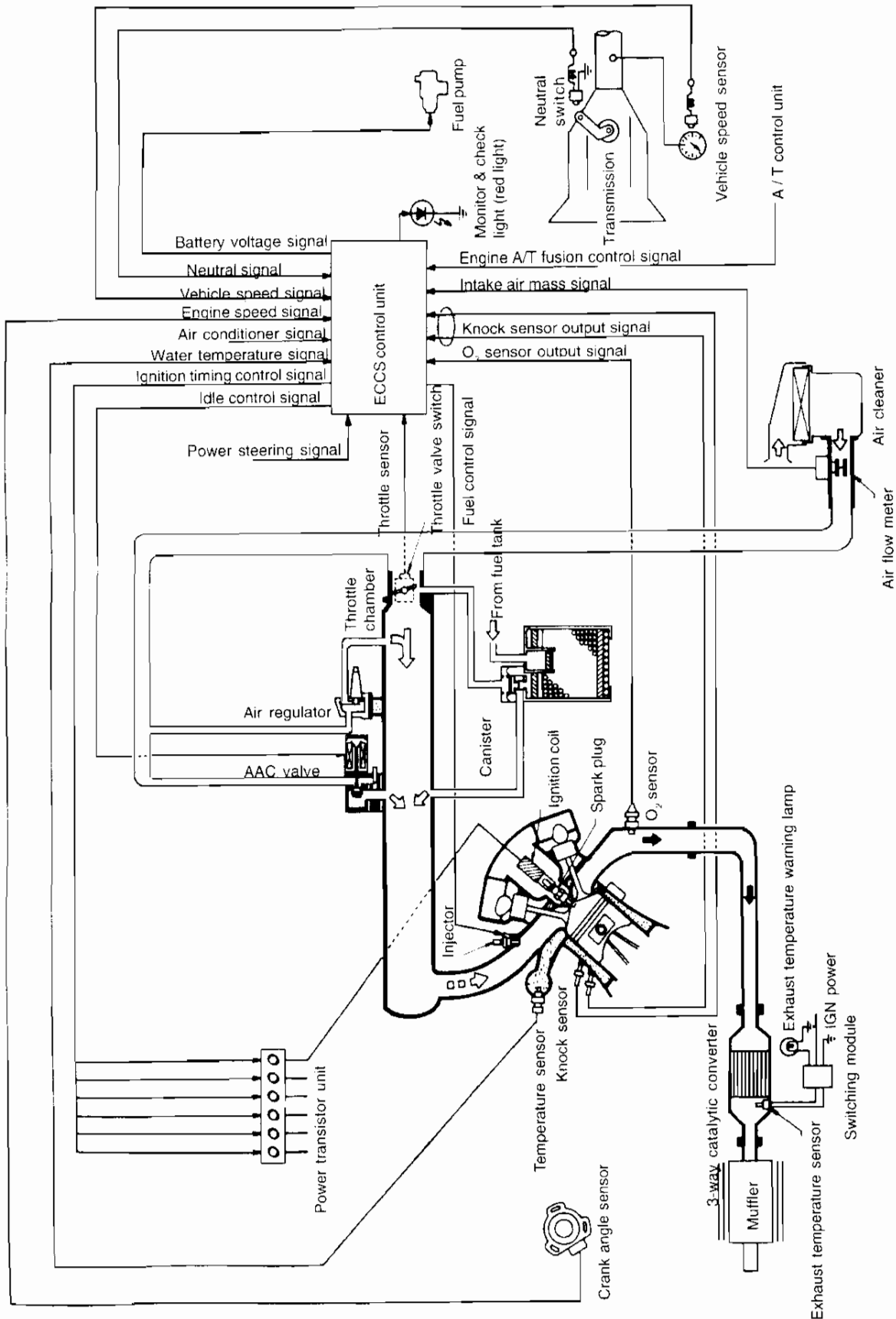

4-2 CIRCUIT DIAGRAM (RB20DE, DET ENGINE)

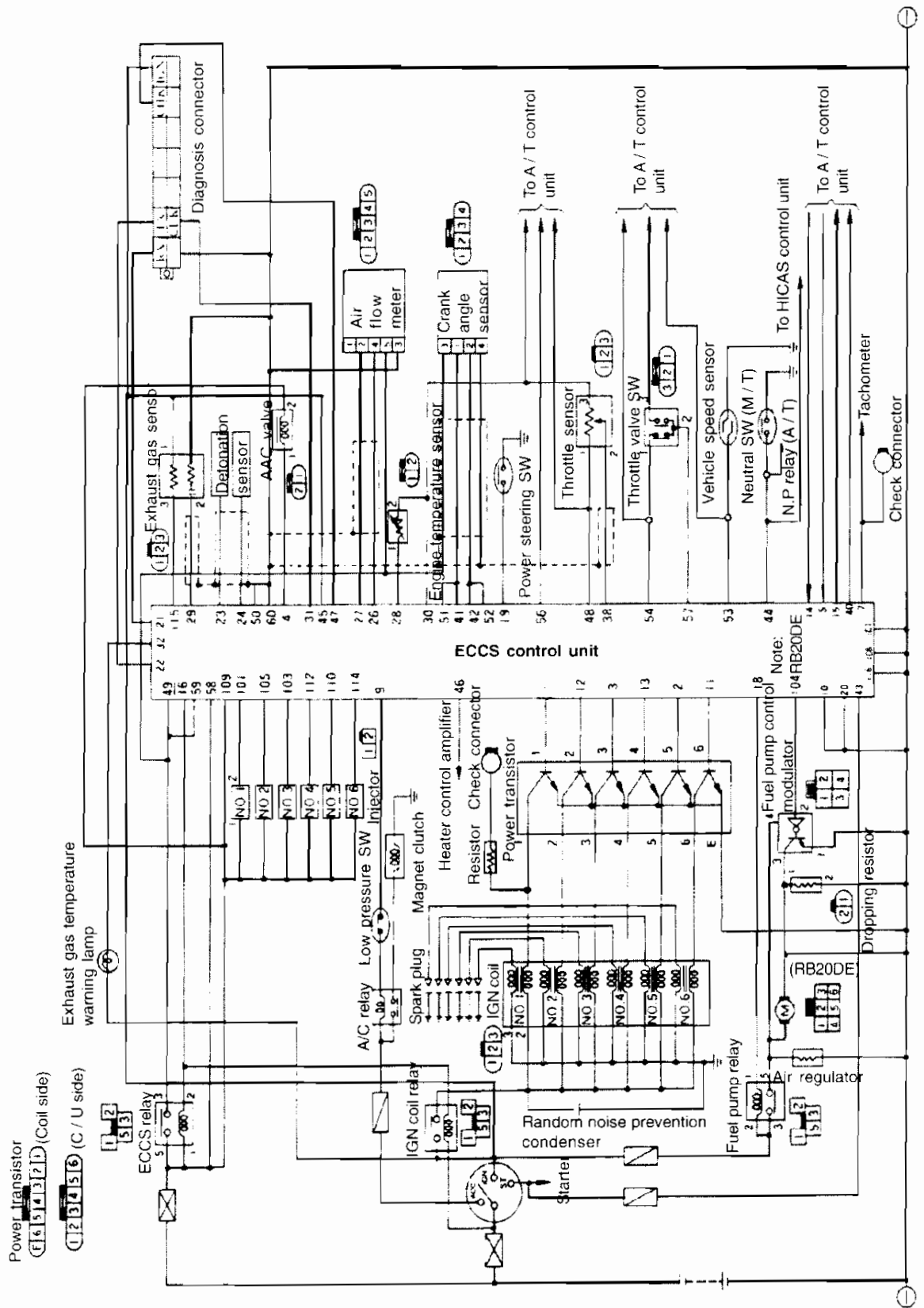

SYSTEM FIGURE & CIRCUIT DIAGRAM

RB20DE / DET ENGINE

ECCS CONTROL UNIT PIN LAYOUT FIGURE (RB20DE, DET ENGINE)

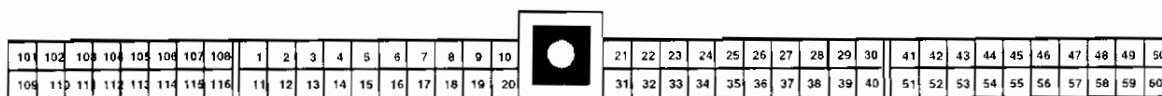

RX	TX			CHK	IGN
-	CLK				

Terminal No.	Description	Terminal No.	Description
1	Ignition timing (Power transistor) Cyl. No.1	11	Ignition timing (Power transistor) Cyl. No.6
2	Ignition timing (Power transistor) Cyl. No.5	12	Ignition timing (Power transistor) Cyl. No.2
3	Ignition timing (Power transistor) Cyl. No.3	13	Ignition timing (Power transistor) Cyl. No.4
4	AAC valve	14	Engine. A/T control input sigal (BT2)
5	Engine. A/T control input sigal (BT1)	15	Engine. A/T control input sigal (BT3)
6	-	16	ECCS relay
7	Tachometer speed signal	17	-
8	-	18	Fuel pump relay
9	Air conditioner relay (A / C cut signal)	19	Power steering switch
10	Ground (ignition signal system)	20	Ground (ignition signal system)
21 (RX)	Recieve (control unit data reception)	31 (CLK)	Clock (synchronization signal)
22 (TX)	Transmit (data sent from control unit)	32	Monitor and check lamp (red)
23	Detonation sensor 1 (cyl 1 ~ 3)	33	-
24	Detonation sensor 1 (cyl 4 ~ 6)	34	-
25	-	35	-
26	Air flow meter ground	36	-
27	Air flow meter intake air signal (rear)	37	-
28	Engine temperature sensor	38	Throttle opening output
29	Exhaust gas sensor	39	-
30	Sensor ground (throttle sen, EGN temp)	40	-
41	Crank angle sensor (120° signal)	51	Crank angle sensor (120° signal)
42	Crank angle sensor (1° signal)	52	Crank angle sensor (1° signal)
43	Ignition switch START signal	53	Vehicle speed sensor
44	Neutral switch	54	Throttle valve switch (Idle connection PT)
45 (IGN)	Ignition switch (IGN)	55	-
46	Air conditioner switch	56	Throttle sensor output signal
47 (CHK)	Check (Diagnosis activation)	57	Throttle valve switch power supply
48	Throttle sensor power supply	58	Battery power supply
49	Control unit power supply	59	Control unit spower supply
50	Ground (Control unit)	60 ( - )	Ground (control unit)
101	Injector No.1	109	Injector power supply
102	-	110	Injector No.5
103	Injector No.3	111	-
104	Fuel pump terminal volt control output (FPCM) RB20DET	112	Injector No.4
105	Injector No.2	113	-
106	-	114	Injector No.6
107	Injector ground	115	Exhaust gas sensor heater ground
108	Injector ground	116	Injector ground

**ECCS COMPONENT PARTS (RB20DE ENGINE)**

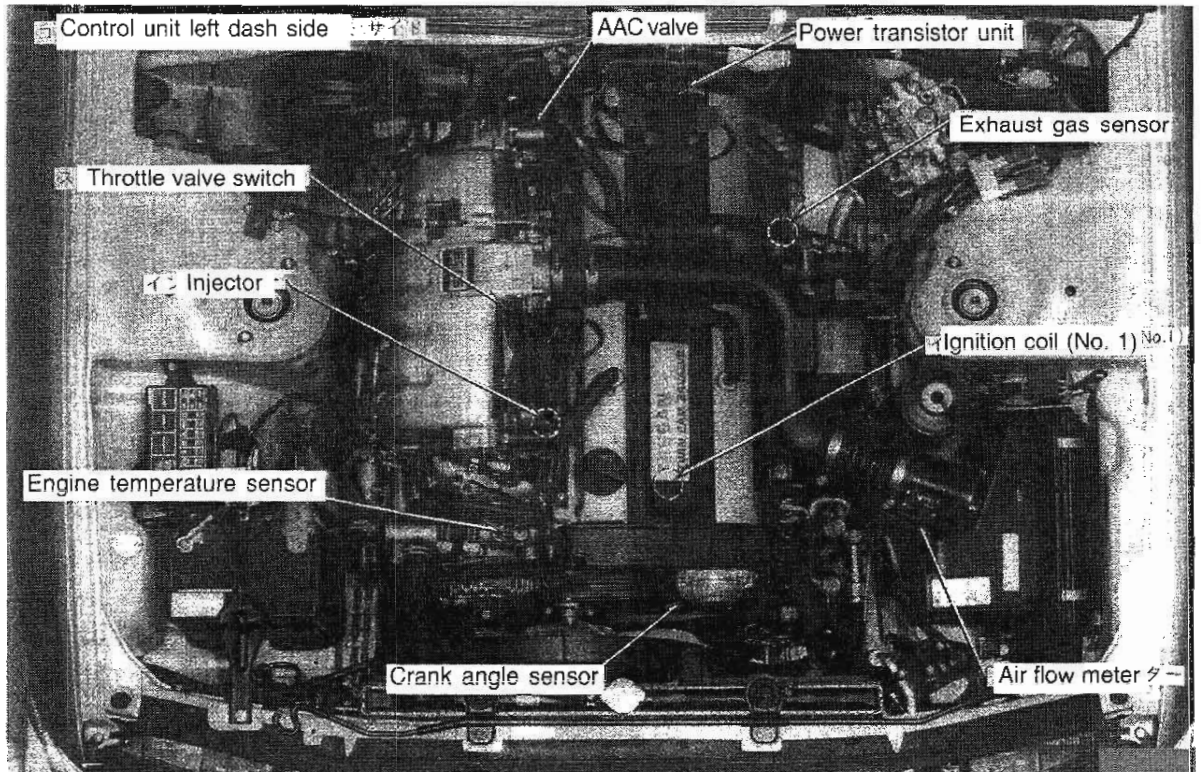

	Component part	Type	Installation position
<b>Actuator system</b>	Injector	Elevation resistor type	Intake manifold
	Fuel pump	Electronic, turbine type	Fuel tank
	AAC valve	Solenoid type	Collector
	Ignition coil	Small mold type	Cylinder head (each pipes)
	Power transistor unit	6-channel electronic distribution	Rocker cover ornament
<b>Sensor system</b>	Crank angle sensor	Photocell type	Cylinder head left bank front
	Air flow meter	Hot wire type	Front left
	Throttle sensor	Variable resistor type	Throttle chamber
	Throttle valve switch	Switch	Throttle chamber
	Engine temperature sensor	Thermistor type	Water outlet
	Exhaust gas sensor	Zirconium type (no heater)	Exhaust manifold
	Detonation sensor	Pressure-electrical type	Cylinder block right side

SYSTEM FIGURE & CIRCUIT DIAGRAM

RB20DET ENGINE

4-1 SYSTEM FIGURE (RB20DET ENGINE)

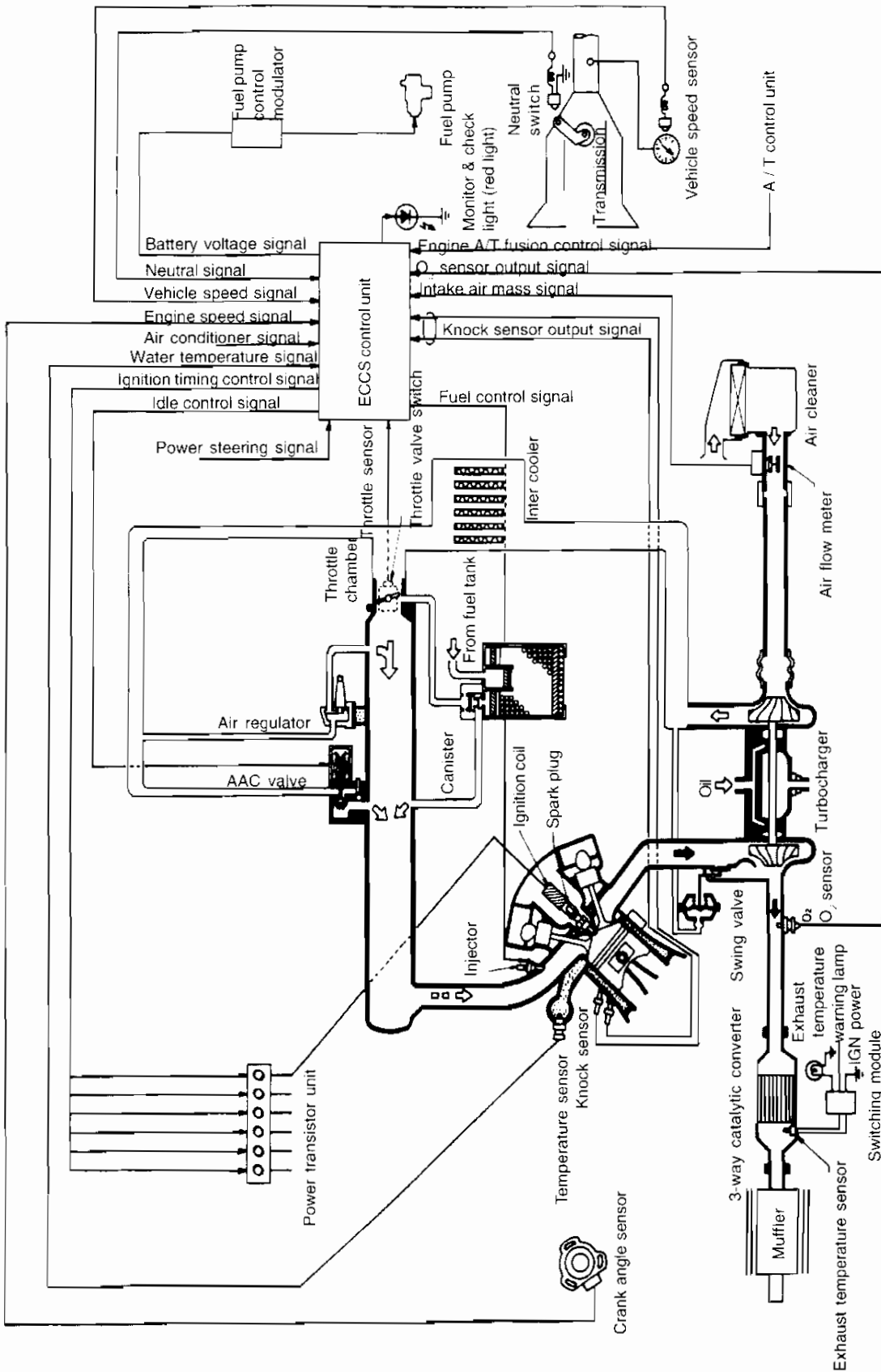

**ECCS COMPONENT PARTS (RB20DET ENGINE)**

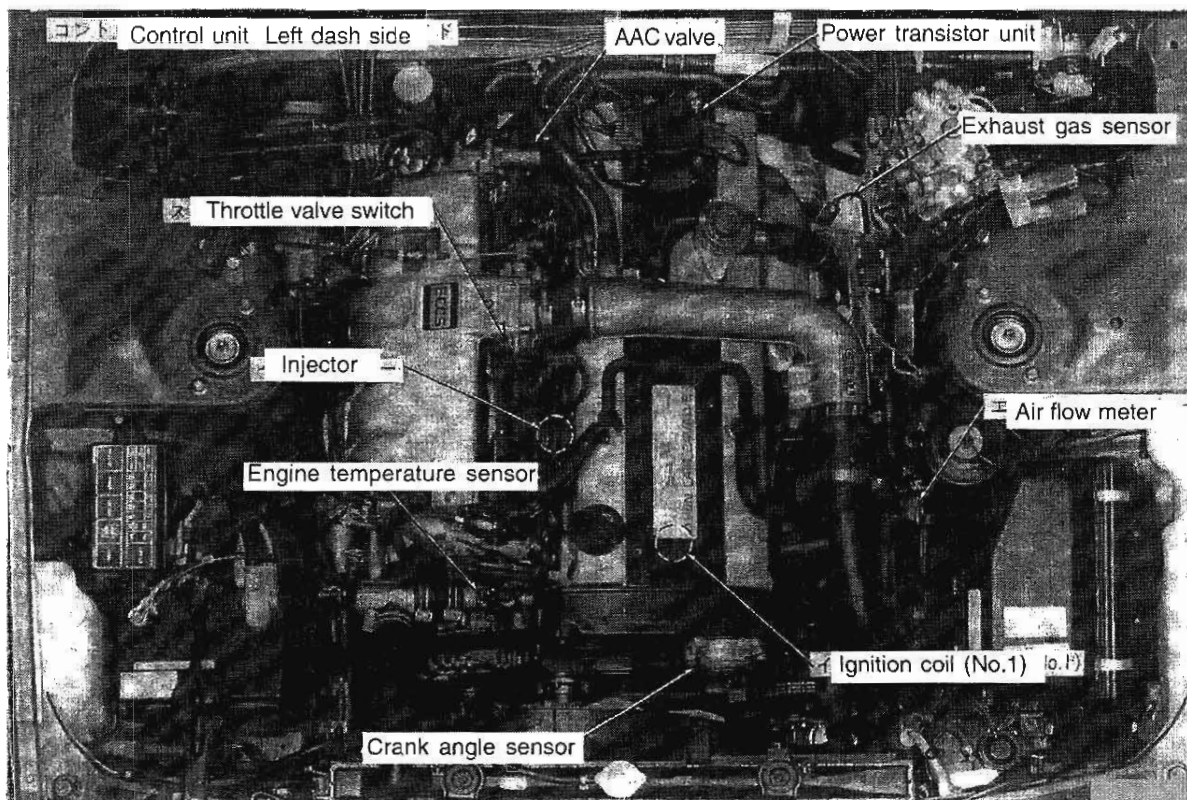

	Component part	Type	Installation position
<b>Actuator system</b>	Injector	Elevation resistor type	Intake manifold
	Fuel pump	Electronic, turbine type	Fuel tank
	AAC valve	Solenoid type	Collector
	Ignition coil	Small mold type	Cylinder head (each pipes)
	Power transistor unit	6-channel electronic distribution	Rocker cover ornament
<b>Sensor system</b>	Crank angle sensor	Photocell type (Auto camshaft )	Cylinder head left bank front
	Air flow meter	Hot wire type	Front left
	Throttle sensor	Variable resistor type	Throttle chamber
	Throttle valve switch	Switch	Throttle chamber
	Engine temperature sensor	Thermistor type	Water outlet
	Exhaust gas sensor	Zirconium type (no heater)	Exhaust outlet
	Detonation sensor	Pressure-electrical type	Cylinder block right side



4-1 SYSTEM FIGURE (CA18i ENGINE)

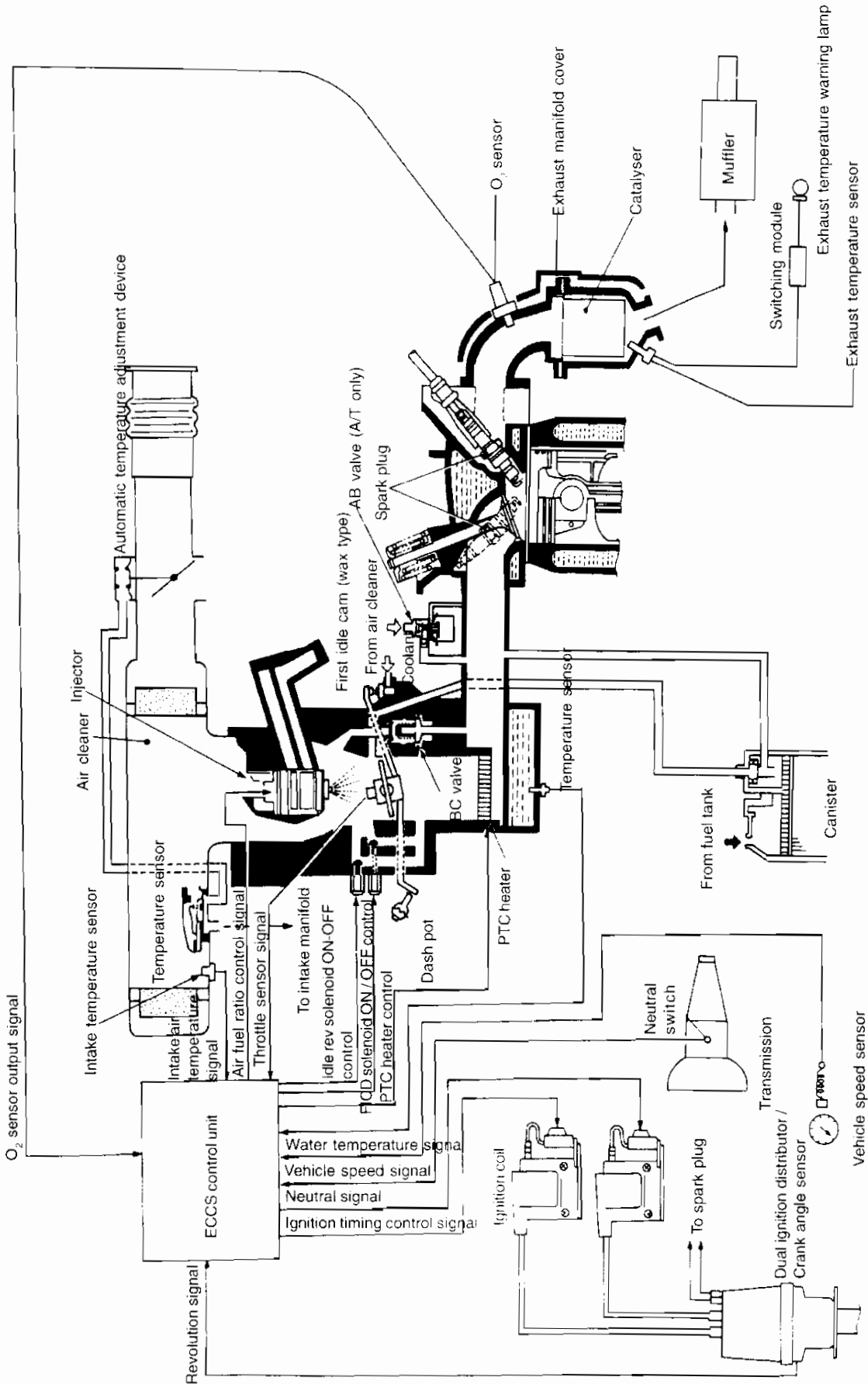



4-2 CIRCUIT DIAGRAM (CA18i ENGINE)

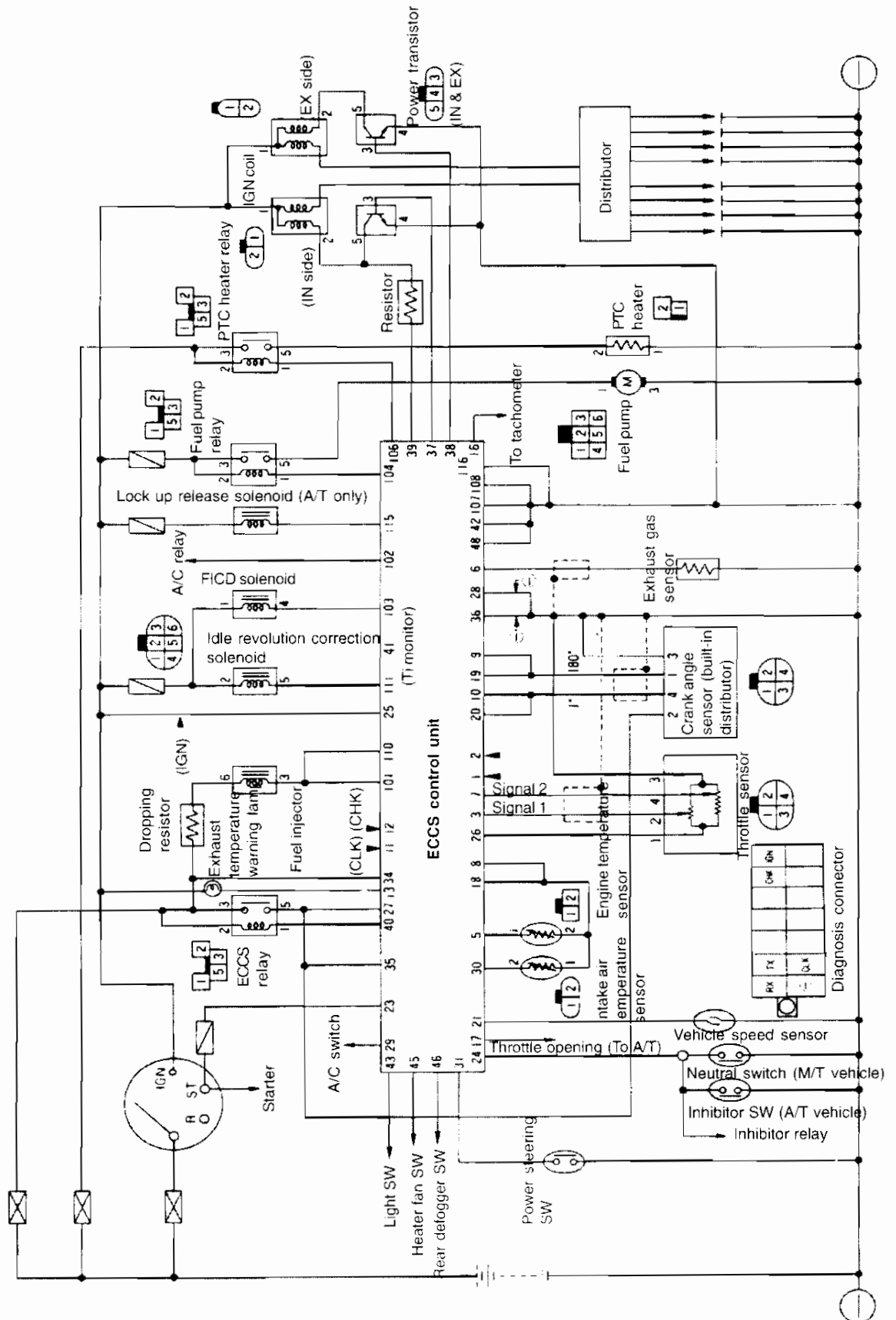

SYSTEM FIGURE & CIRCUIT DIAGRAM

CA18i ENGINE

ECCS CONTROL UNIT PIN LAYOUT FIGURE (CA18i ENGINE)

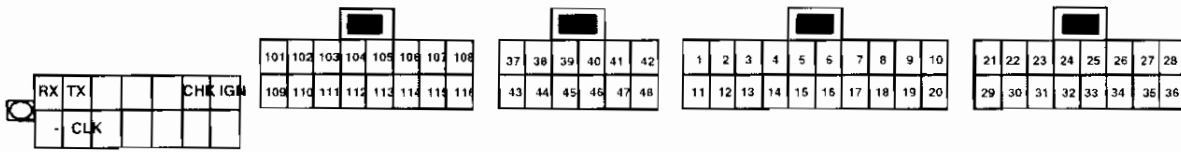

Terminal No.	Description	Terminal No.	Description
1(RX)	Recieve (control unit dara reception)	11(CLK)	Clock (synchronization signal)
2(TX)	Transmit (data sent from control unit)	12(CHK)	Check (diagnosis activation)
3	Throttle sensor signal 1	13	Monitor & check lamp (red)
4	-	14	-
5	Engine temperature sensor	15	-
6	Exhaust gas sensor	16	Tachometer speed signal
7	Throttle sensor signal 2	17	Throttle opening output (A/T)
8	Ground (sensor)	18	Ground (sensor)
9	180° signal	19	180° signal
10	1° signal	20	1° signal
21	Vehicle speed sensor	29	Air conditioner switch
22	-	30	Intake air temperature sensor
23	Ignition switch "START" signal	31	Power steering switch
24	Neutral switch, inhibitor switch	32	-
25(IGN)	Ignition switch "ON"	33	-
26	Throttle sensor power supply	34	Control unit back up power supply
27	Control unit power supply	35	Control unit power supply
28(-)	Ground (circuit)	36(-)	Ground (circuit)
37	Ignition signal (Intake side)	43	Light switch
38	Ignition signal (Exhaust side)	44	-
39	Ignition primary signal	45	Heater fan switch
40	ECCS relay	46	Rear defogger switch
41	Ti monitor (injection pulse monitor)	47	-
42	Ground (ignition)	48	Ground (ignition)
101	injector	109	-
102	Air conditioner relay	110	injector
103	FICD solenoid	111	Idle revolution correction solenoid
104	Fuel pump relay	112	-
105	-	113	-
106	PTC heater relay	114	-
107	Injector ground	115	Lock up release solenoid (A/T only)
108	Injector ground	116	Injector ground

**ECCS COMPONENT PARTS (CA18i ENGINE)**

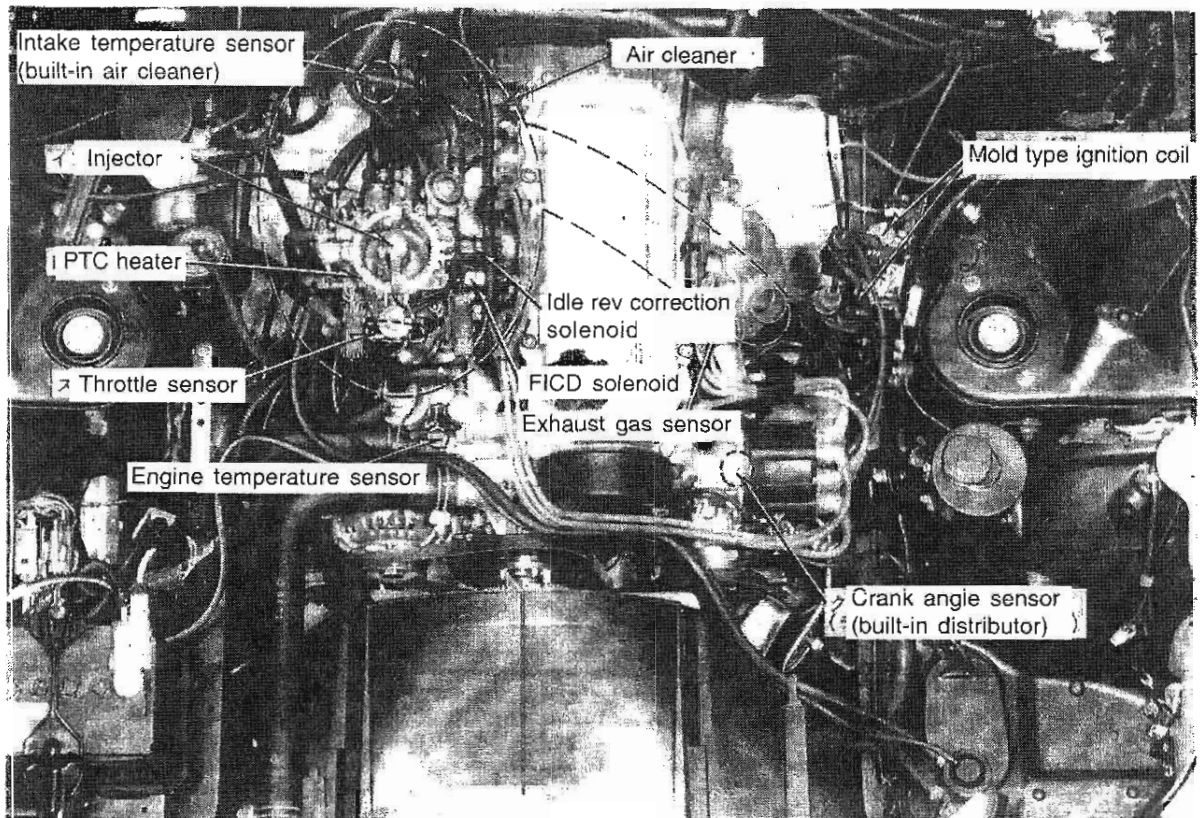

	Component part	Type	Installation position
<b>Actuator system</b>	Injector	Side flow type	Throttle side body
	Fuel pump	Electronic. turbine type	Fuel tank
	Ignition coil	Mold type	Engine bay left side
	Idle speed correction solenoid	Solenoid type	Throttle body
	FICD solenoid	Solenoid type	Throttle body
	PTC heater	Coil type	Throttle body ~ intake manifold
<b>Sensor system</b>	Crank angle sensor	Photocell type	Built in distributor
	Intake air temperature sensor	Thermistor type	Air cleaner
	Throttle sensor	Variable resistor type	Throttle body
	Engine temperature sensor	Thermistor type	Intake manifold
	Exhaust gas sensor	Zirconium type (no heater)	Exhaust manifold



4-2 CIRCUIT DIAGRAM (RB25DE ENGINE)

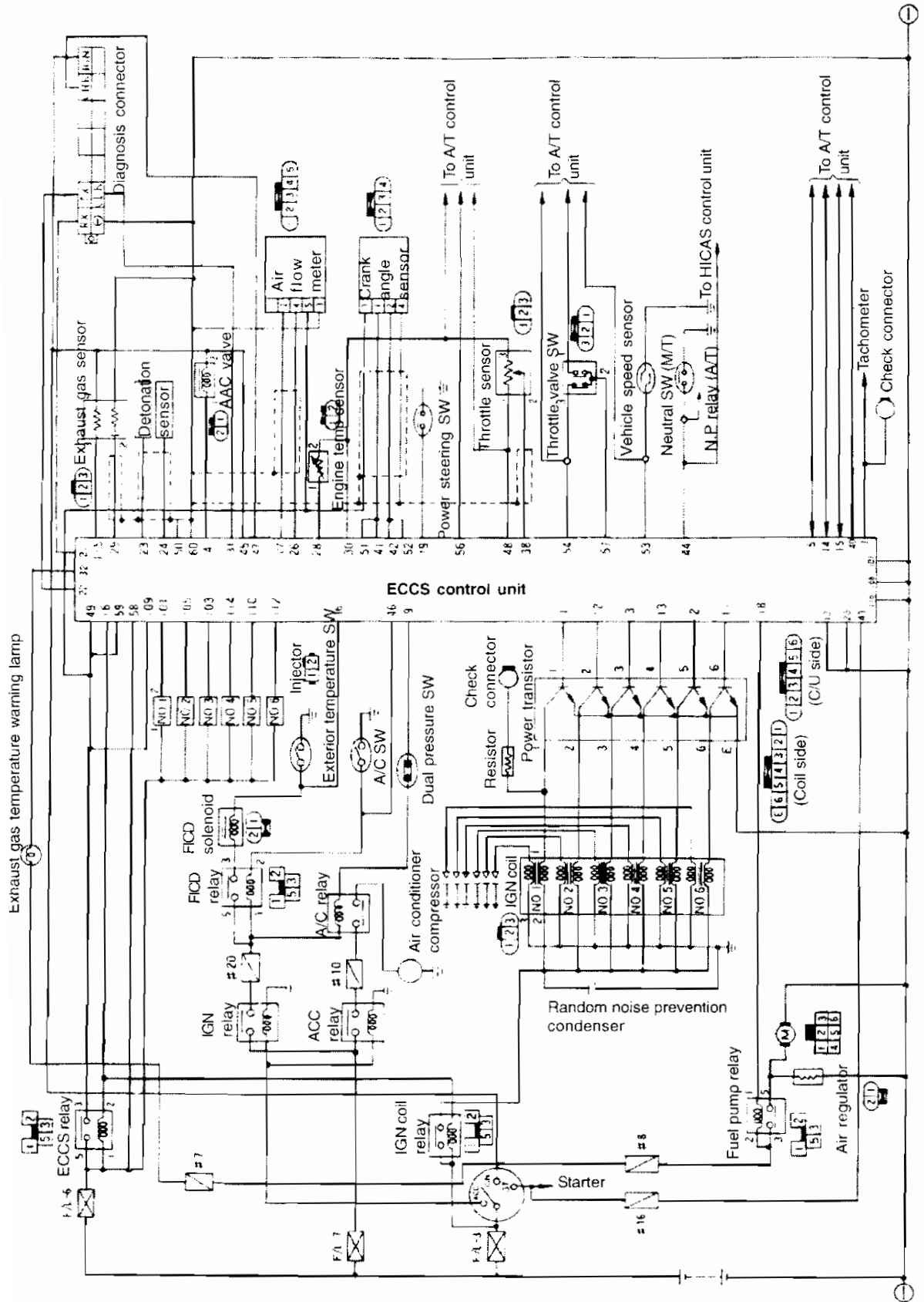

SYSTEM FIGURE & CIRCUIT DIAGRAM

RB25DE ENGINE

ECCS CONTROL UNIT PIN LAYOUT FIGURE (RB25DE ENGINE)

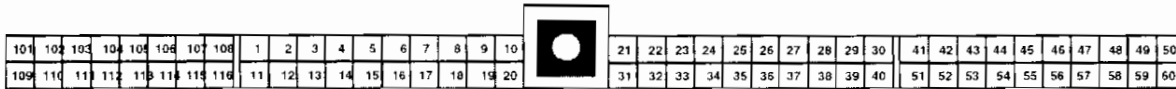

RX	TX			CHK	IGN
-	CLK				

Terminal No.	Description	Terminal No.	Description
1	Ignition timing (Power transistor) Cyl. No.1	11	Ignition timing (Power transistor) Cyl. No.6
2	Ignition timing (Power transistor) Cyl. No.5	12	Ignition timing (Power transistor) Cyl. No.2
3	Ignition timing (Power transistor) Cyl. No.3	13	Ignition timing (Power transistor) Cyl. No.4
4	AAC valve	14	Engine. A/T control input sigal (BT2)
5	Engine. A/T control input sigal (BT1)	15	Engine. A/T control input sigal (BT3)
6	-	16	ECCS relay
7	Tachometer speed signal	17 ( f )	-
8	-	18	Fuel pump relay
9	Air conditioner relay (A / C cut signal)	19	Power steering switch
10	Ground (ignition signal system)	20	Ground (ignition signal system)
21 (RX)	Receive (control unit data reception)	31 (CLK)	Clock (synchronization signal)
22 (TX)	Transmit (data sent from control unit)	32	Monitor and check lamp (red)
23	Detonation sensor 1 (cyl 1 ~ 3)	33	-
24	Detonation sensor 1 (cyl 4 ~ 6)	34	-
25	-	35	-
26	Air flow meter ground	36	FICD solenoid input signal
27	Air flow meter intake air signal	37	-
28	Engine temperature sensor	38	Throttle opening output
29	Exhaust gas sensor	39	-
30	Ground (Sensor)	40	Intake air output signal (To A/T C/U)
41	Crank angle sensor (120° signal)	51	Crank angle sensor (120° signal)
42	Crank angle sensor (1° signal)	52	Crank angle sensor (1° signal)
43	Ignition switch START signal	53	Vehicle speed sensor
44	Neutral switch	54	Throttle valve switch (Idle connection PT)
45 (IGN)	Ignition switch (IGN)	55	-
46	Air conditioner switch	56	Throttle sensor output signal (To A/T C/U)
47 (CHK)	Check (Diagnosis activation)	57	Throttle valve switch power supply
48	Throttle sensor power supply	58	Battery power supply
49 ( b )	Control unit power supply	59	Control unit spower supply
50	Ground (Control unit)	60 ( - )	Ground (control unit)
101	Injector No.1	109	Injector power supply
102	-	110	Injector No.5
103	Injector No.3	111	-
104	-	112	Injector No.4
105	Injector No.2	113	-
106	-	114	Injector No.6
107	Injector ground	115	Exhaust gas sensor heater ground
108	Injector ground	116	Injector ground

**ECCS COMPONENT PARTS (RB25DE ENGINE)**

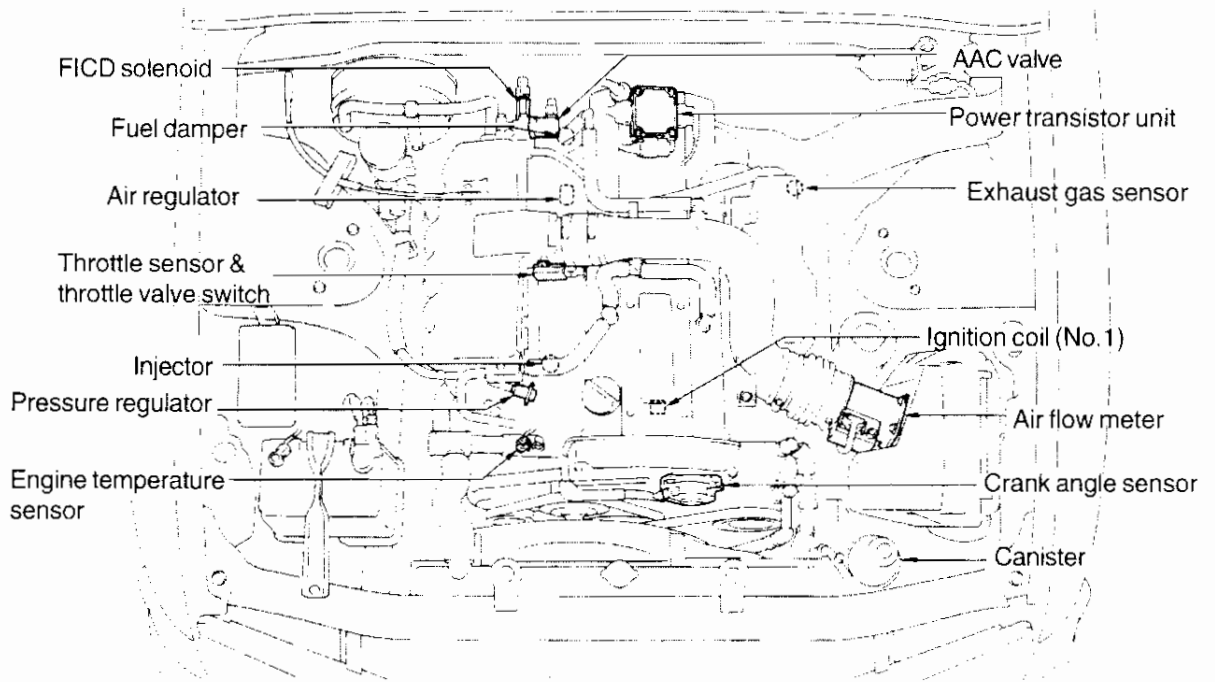

	<b>Component part</b>	<b>Type</b>	<b>Installation position</b>
<b>Actuator system</b>	Injector	Elevation resistor type	Fuel tube
	Fuel pump	Electronic turbine type	Fuel tank
	AAC valve	Solenoid type	Intake manifold collector
	FICD solenoid	Solenoid type	Intake collector manifold
	Ignition coil	Small mold type	Cylinder head (above each plug)
	Power transistor unit	6-channel low voltage electronic distribution	Rocker cover ornament
<b>Sensor system</b>	Crank angle sensor	Photocell type	Cylinder head left front side
	Air flow meter	Hot wire type	Front left
	Throttle valve switch	ON / OFF switch	Throttle chamber
	Throttle sensor	Variable resistor type	Throttle chamber
	Engine temperature sensor	Thermistor type	Water outlet
	Exhaust gas sensor	Zirconium type (no heater)	Exhaust manifold
	Detonation sensor	Pressure-electrical type	Cylinder block

## 5. ACTUATOR SYSTEM INSPECTION

Use measurement tools such as a circuit tester, CONSULT electrical system diagnosis tester and oscilloscope to perform inspections. Refer to EN3, 1, 1-1, (6) in TROUBLE DIAGNOSIS section for the measurement equipment operation procedures.

The following preparation must be performed when using this equipment.

### (1) Using circuit tester and oscilloscope

#### RB20E

- Insert the testing rod from ECCS harness connector side.
- ECCS control unit and ECCS harness connector must be connected when measurements are carried out.

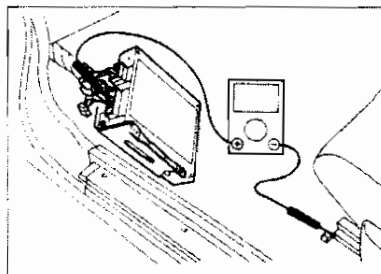

#### RB20DE / DET / RB25DE / RB26DETT

- Always use check adapter to perform the measurement.

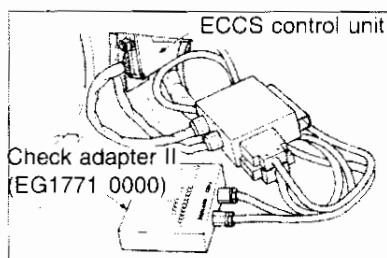

### (2) Using CONSULT

- Connect CONSULT to the diagnostic connector on the vehicle (near fuse block).

#### Note:

See EN3, 2, 2-2, (2) in TROUBLE DIAGNOSIS section for details.

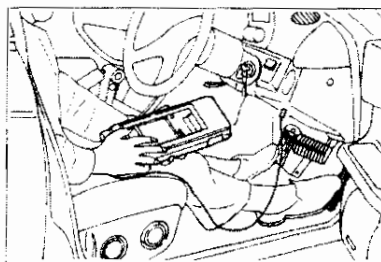



**5-1 FUEL PUMP SYSTEM INSPECTION**  
**CONTROL CIRCUIT DIAGRAM RB26DETT ENGINE**

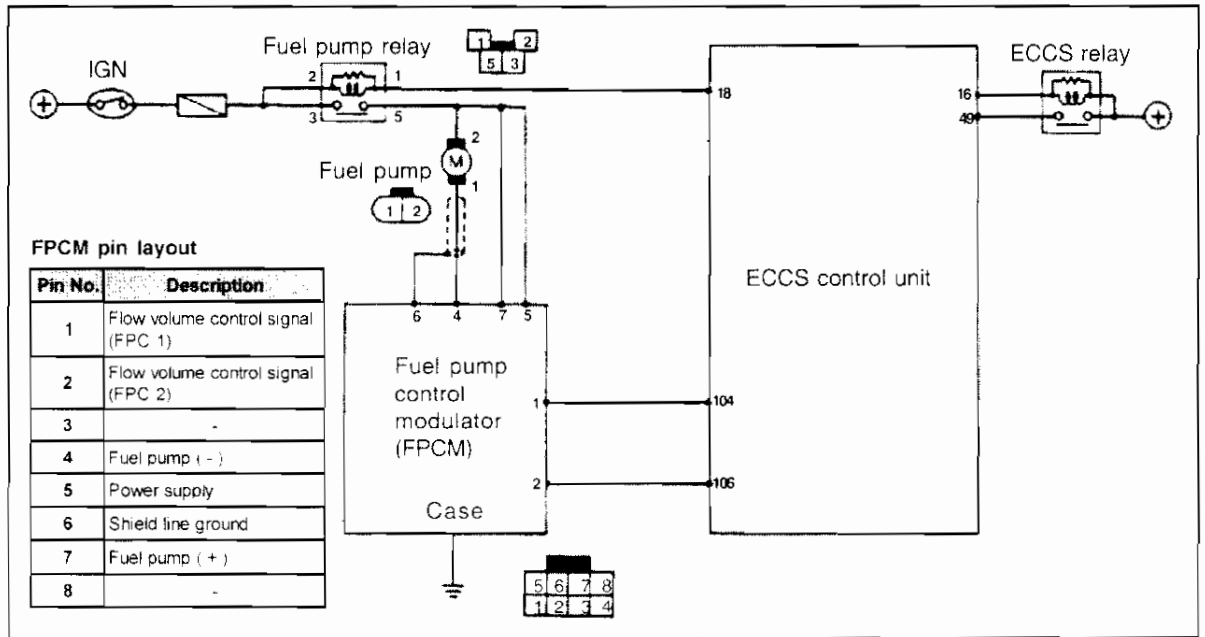

**Fuel pump system trouble diagnosis flowchart RB26DETT ENGINE**

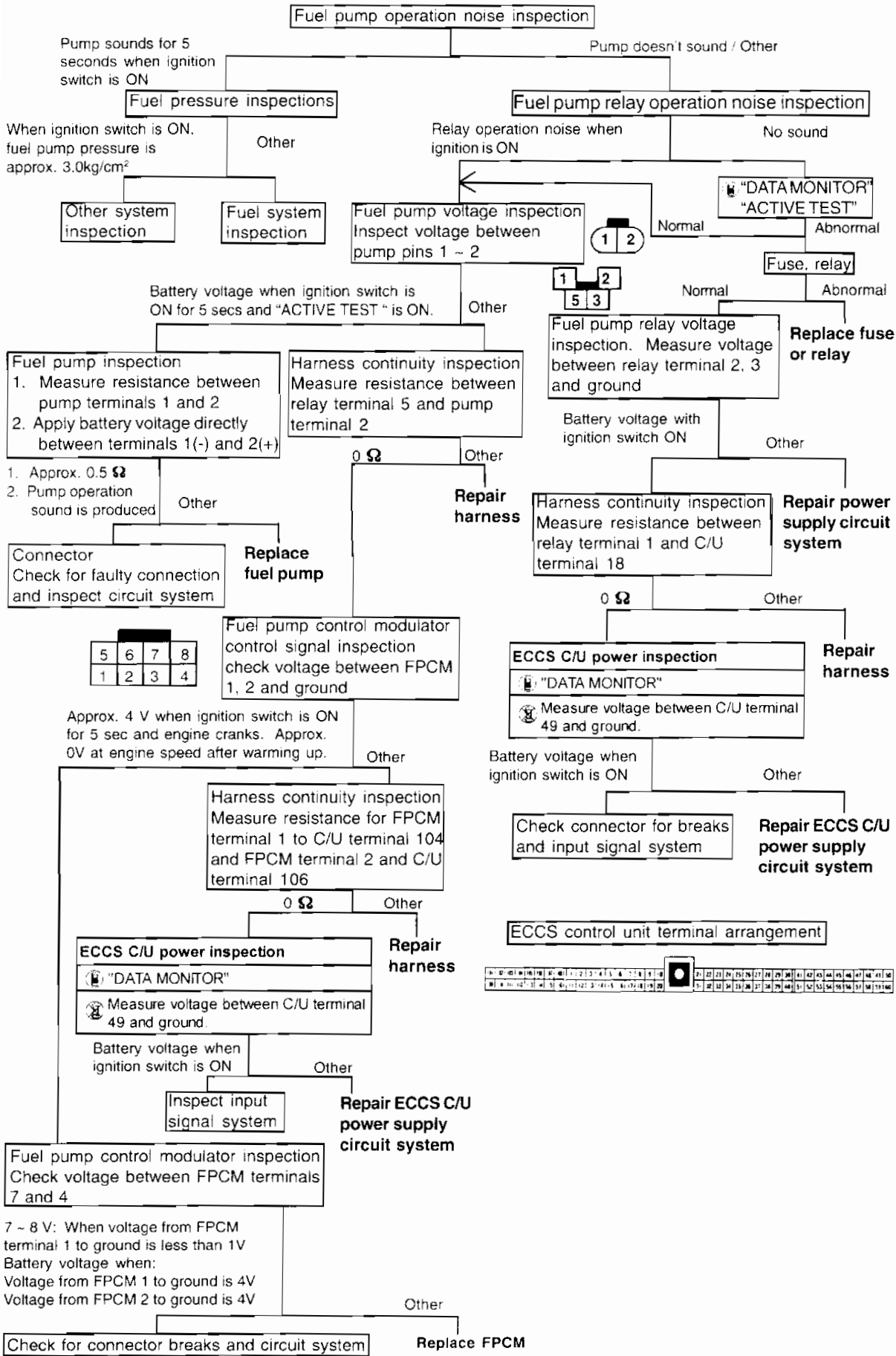

**5-1 FUEL PUMP SYSTEM INSPECTION**  
**CONTROL CIRCUIT DIAGRAM RB20E / DE / DET ENGINE**

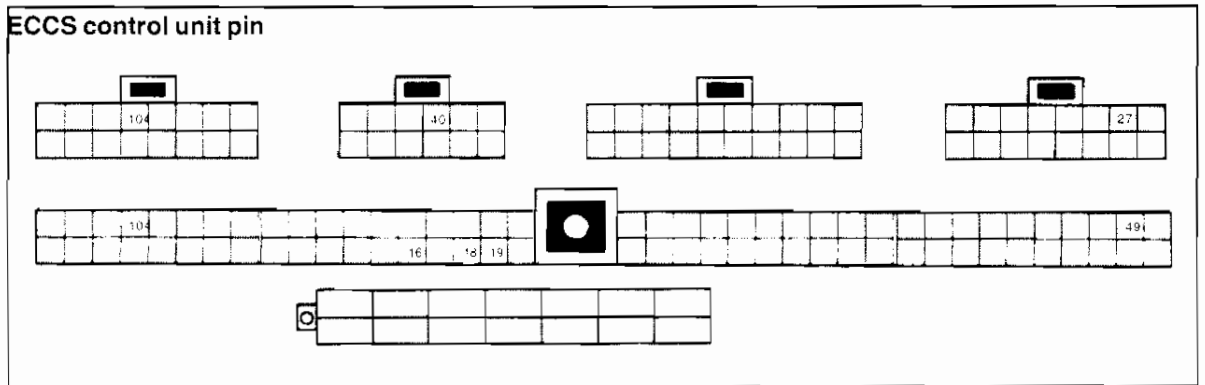
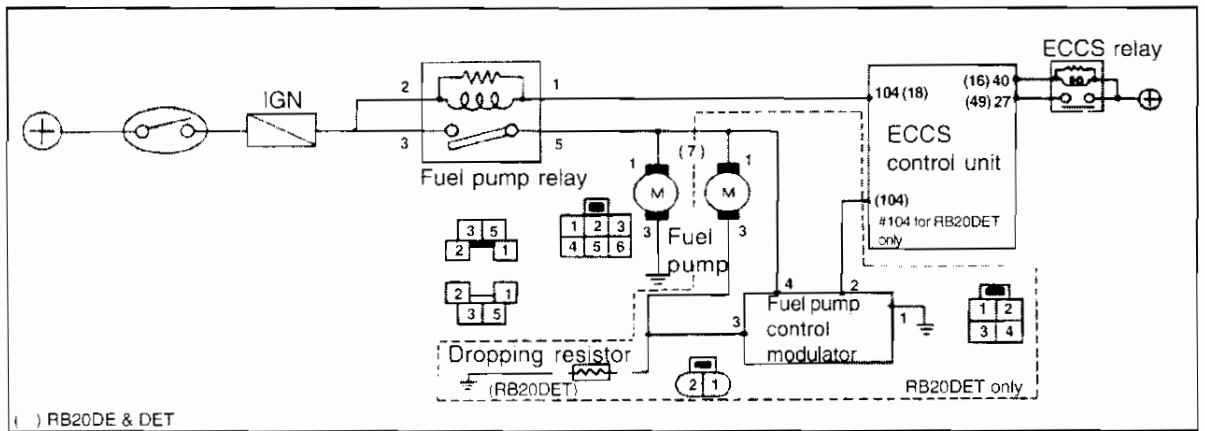



**5-1 FUEL PUMP SYSTEM INSPECTION  
CONTROL CIRCUIT DIAGRAM CA18i ENGINE**

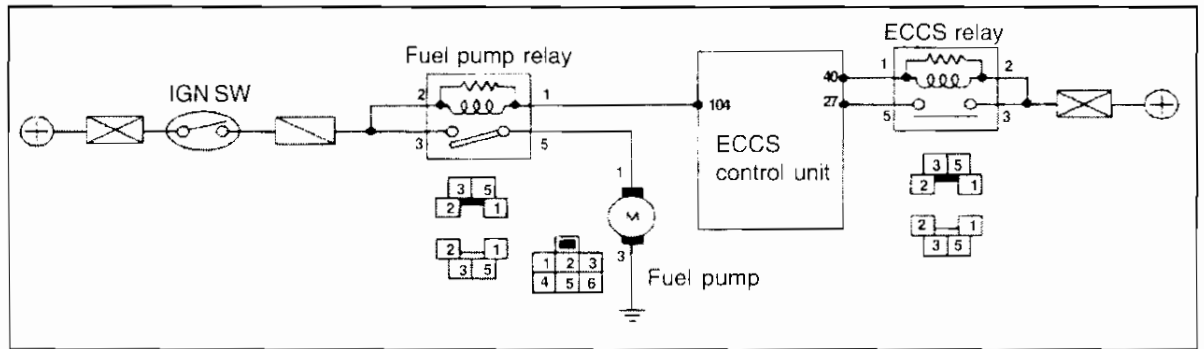

**Fuel pump system trouble diagnosis flowchart CA18i ENGINE**

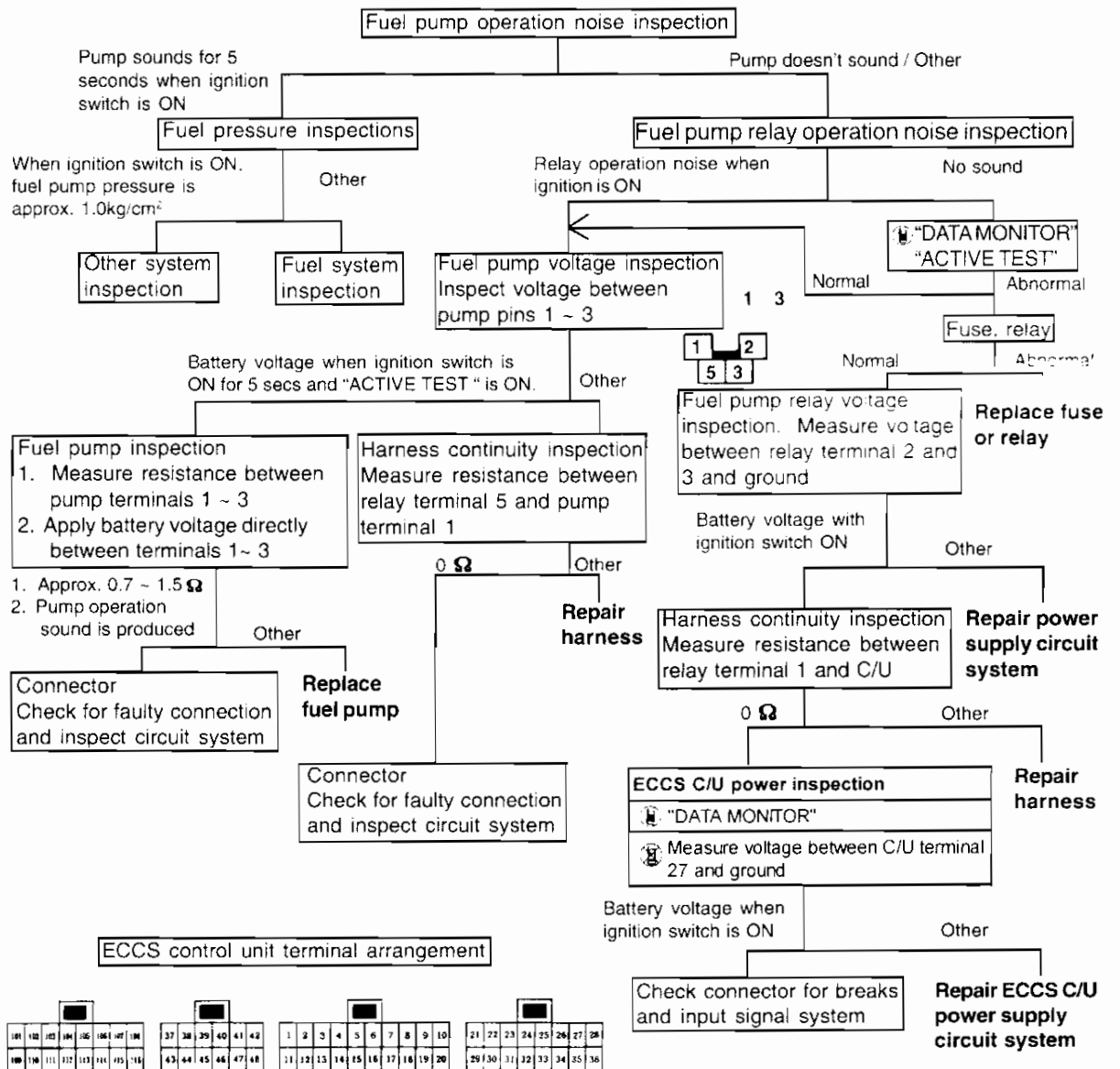

**(1) Fuel pump relay operation inspection**

- Place the ignition switch ON and select "FUEL PUMP RELAY" in "ACTIVE TEST" mode. Press the ON button and check for pump operation noise.

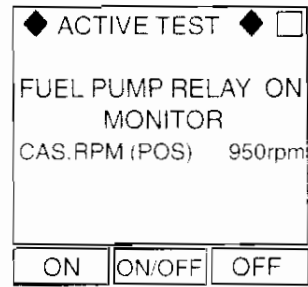

- When the ignition switch is in ON position, the relay operation noise must be audible. There must be a relay cut off noise 5 seconds later.
- After engine has stopped (stall), turn the ignition switch to OFF position 1.5 seconds later.

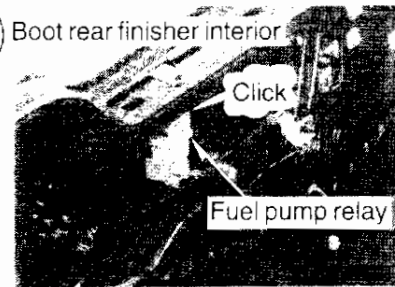

**(2) Fuel pump relay power inspection**

- Disconnect the fuel pump relay and measure the voltage between following terminals and ground when the ignition switch is placed in ON position.

Engine	RB26DETT / RB20E, DE, DET / CA18i	
Item	Between terminal 2 on fuel pump relay harness side and ground	Between terminal 3 on fuel pump relay harness side and ground
Condition		
When ignition switch is ON	Battery voltage	

**RB26DETT**

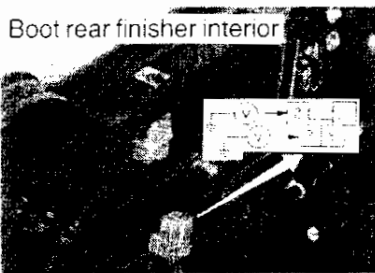

**CA18i**

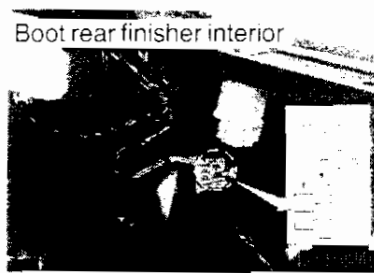

**RB20E / DE / DETT**

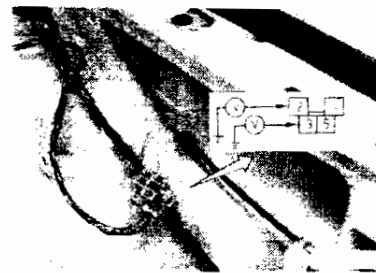

**(3) Fuel pump control signal inspection**

- Select "FUEL PUMP RELAY" in "DATA MONITOR" mode and check the following.



Item	Fuel pump relay
When ignition switch is ON (engine is not running)	OFF
When cranking engine	ON
When idling	ON

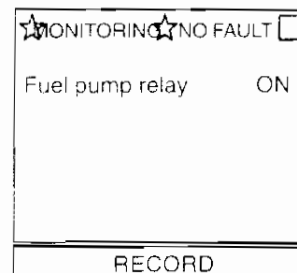

- Measure the voltage between the following terminals and ground when the ECCS control unit connectors are connected.

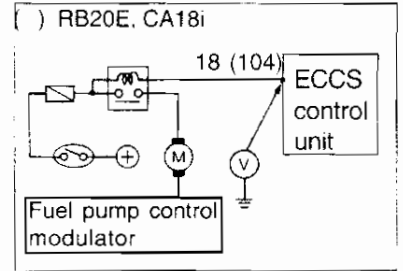

Engine		RB26DETT	CA18i	RB20E	RB20DE, DET
Measurement location		Between terminal 18 and ground	Between terminal 104 and ground	Between terminal 104 and ground	Between terminal 18 and ground
Condition					
Ignition switch is ON (engine stopped)	Within 5 secs right after turning switch to ON	Approx. 1V	Approx. 0V	Approx. 1V	Approx. 1V
	After 5 secs right after turning switch to ON	Battery voltage	Battery voltage	Battery voltage	Battery voltage
Cranking engine		Approx. 1V	Approx. 0V	Approx. 0V	Approx. 0V
Idling		Approx. 1V	Approx. 0V	Approx. 1V	Approx. 1V

**(4) Fuel pump control modulator control signal inspection (RB26DETT & RB20DET only)**

- Measure voltage between the following terminals and the ground when the ECCS control unit connectors are connected.

Engine	RB26DETT	
Measurement location	Between terminal 104 and ground (FPCM1)	Between terminal 106 and ground (FPCM2)
Condition		
Ignition switch ON	4V, 0V after 5 sec	4V, 0V after 5 sec
Starting with heavy load	Approx. 4V	Approx. 4V
Idling	Approx. 0V	Approx. 0V
Medium load	Approx. 4	Approx. 0V

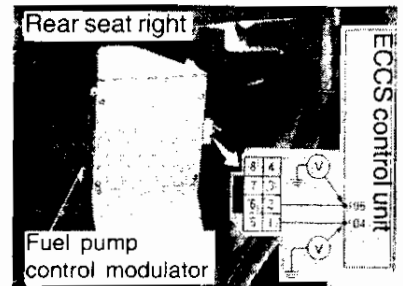

Engine	RB20DET
Measurement location	Between terminal 104 and ground
Condition	
Ignition switch ON	0V
When cranking	0V
Engine running	When cold: 0V After warm-up: Power supply voltage

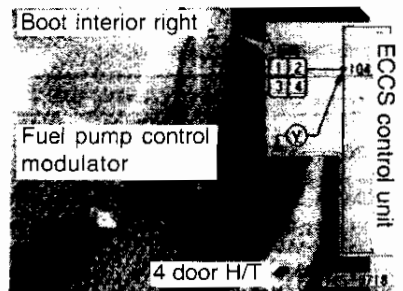

**(5) ECCS control unit power supply inspection**

- Select "BATTERY VOLTAGE" in "DATA MONITOR" mode and carry out the following inspection.



	Battery voltage
Ignition switch ON	11 ~ 14V

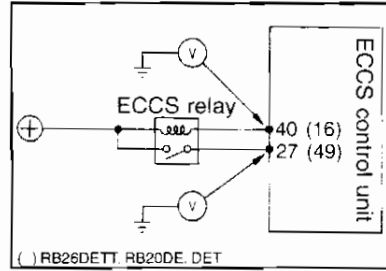

**Note:**

The same setting as ON state is maintained for a few seconds right after the ignition switch is turned ON to OFF and then ON again.

- Measure the voltage between the following terminals and the ground when the ECCS control unit connectors are connected.



ENGINE	CA18i, RB20E		RB26DETT, RB20DE, DET	
<b>Measurement location</b>	Between ECCS C/U terminal 40 and ground	Between ECCS C/U terminal 27 and ground	Between ECCS C/U terminal 16 and ground	Between ECCS C/U terminal 49 and ground
<b>Ignition switch OFF</b>	Battery voltage	0V	Battery voltage	0V
<b>Ignition switch ON</b>	0V	Battery voltage	0V	Battery voltage
<b>When cranking</b>	0V	Battery voltage	0V	Battery voltage
<b>When idling</b>	0V	Battery voltage	0V	Battery voltage

**(6) Harness continuity inspection**

- Disconnect ECCS control unit, fuel pump relay and fuel pump harness connectors and measure resistance between the following terminals.

Engine	CA18i	RB20E	RB20DE, DET	RB26DETT
Between ECCS C/U harness terminal 104 and fuel pump relay harness terminal 1	0 Ω	0 Ω	-	-
Between fuel pump harness terminal 1 and fuel pump relay harness terminal 5	0 Ω	0 Ω	0 Ω	-
Between ECCS C/U harness terminal 18 and fuel pump relay harness terminal 1	-	-	0 Ω	0 Ω
Between fuel pump harness terminal 2 and fuel pump relay harness terminal 5	-	-	-	0 Ω

CA18i / RB20E / DE / DET

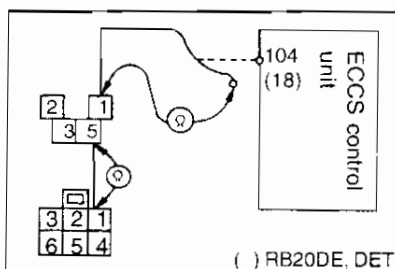

RB26DETT

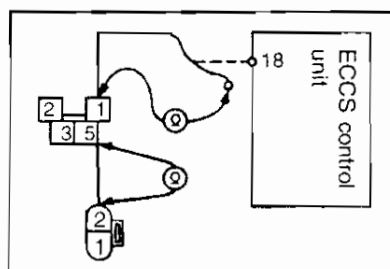



[RB20DET & RB26DETT only]

- Disconnect each connector and measure the resistance between the following terminals.

Measurement location	RB20DET
Between ECCS C/U terminal 104 and FPCM harness terminal 2	$0 \Omega$
Between dropping resistor harness terminal 1 and FPCM harness terminal 3	
Between fuel pump relay harness connector 5 and FPCM harness connector 4	
Between fuel pump harness terminal 1 and FPCM harness connector 4	

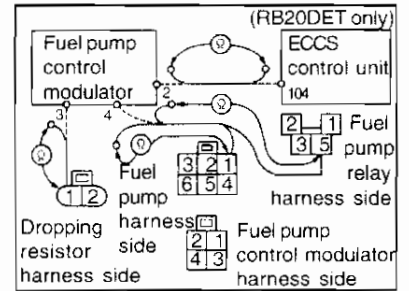

Measurement location	RB26DETT
Between ECCS C/U terminal 104 and FPCM harness terminal 1	$0 \Omega$
Between ECCS C/U terminal 106 and FPCM harness terminal 1	
Between fuel pump relay harness connector 5 and FPCM harness connector 5	
Between fuel pump relay harness connector 5 and FPCM harness connector 7	
Between fuel pump harness terminal 1 and FPCM harness connector 4	

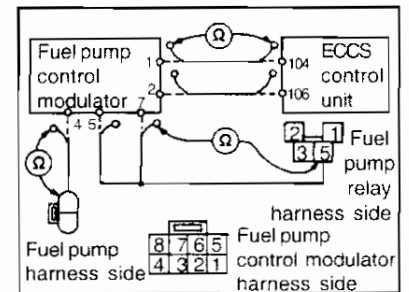

(7) Fuel pump voltage inspection

- Disconnect the fuel pump connector and measure the voltage between the following terminals and ground.

Engine	RB20E / DE / DET / RB26DETT	CA18i
Condition	Between fuel pump harness terminal 2 and ground	Between fuel pump harness terminal 1 and ground
For 5 seconds after ignition switch is turned ON	Battery voltage	Battery voltage
Cranking	Battery voltage	Battery voltage

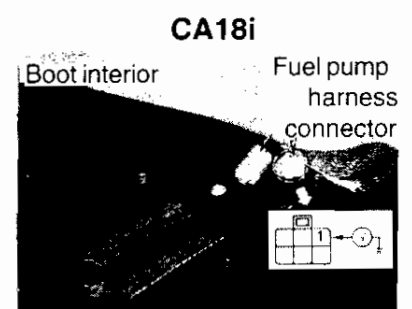
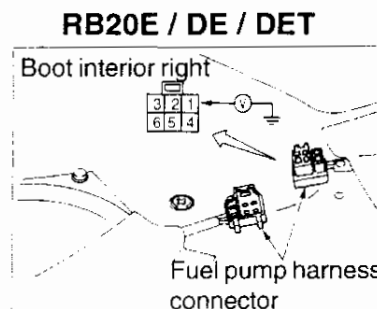
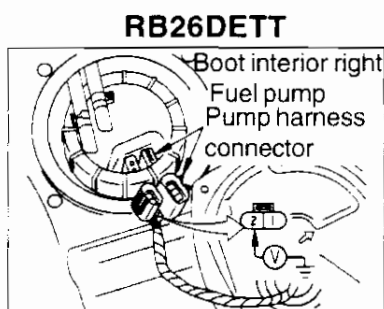

## ACTUATOR SYSTEM INSPECTION

RB26DETT / RB20E / DE / DET / CA18i ENGINE

### (8) Fuel pump inspection

- Disconnect the fuel pump connector and measure the resistance between the following fuel pump terminals.

Engine	RB26DETT	RB20E / DE / DET	CA18i
Measurement location	Between fuel pump terminal 1 and 2	Between fuel pump terminal 1 and 3	
	0.4 ~ 0.7 $\Omega$	0.4 ~ 0.7	0.7 ~ 1.5

**RB26DETT**

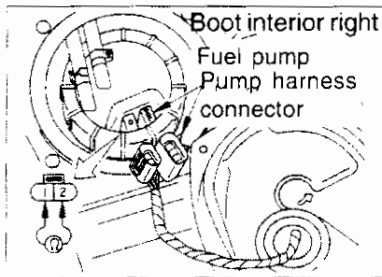

**RB20E / DE / DET**

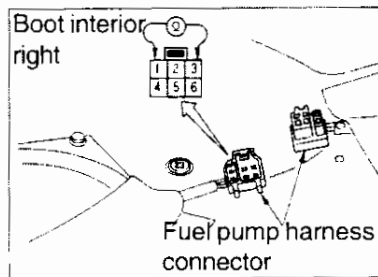

**CA18i**

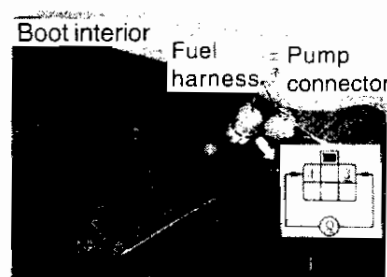

- Check the fuel pump operation by disconnecting the fuel pump connectors and apply the battery voltage directly to the following fuel pump terminals.

Pump terminal 1 (2) to battery positive terminal (+).

Pump terminal 3 (1) to battery negative terminal (-).

( ) RB26DETT only.

**RB26DETT**

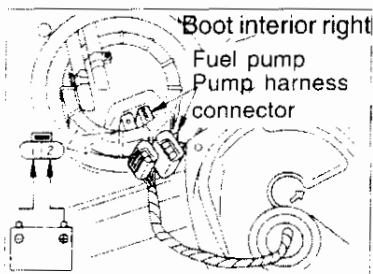

**RB20E / DE / DET**

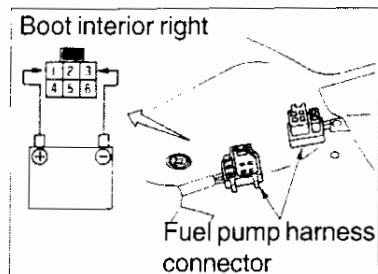

**CA18i**

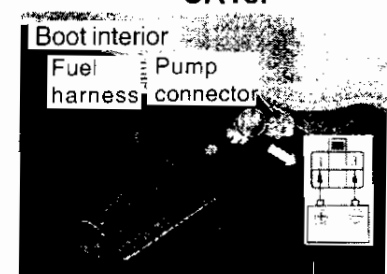

### (9) Dropping resistor inspection (RB20DET only)

- Disconnect dropping resistor harness connector and measure the resistance between the following terminals.

Between dropping resistor terminal 1 and 2

0.5  $\Omega$

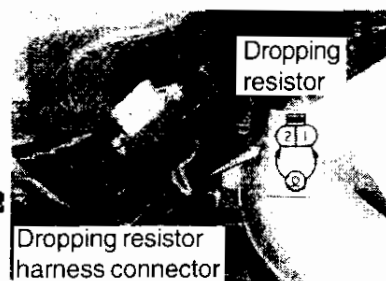

**(10) Fuel pump control modulator inspection  
(RB26DETT only)**

- When the fuel pump control modulator connector is connected, measure the voltage between the following terminals.

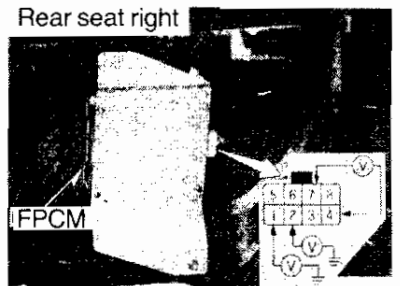

Measurement location	Condition	Voltage between FPCM terminal 1 and ground	Voltage between FPCM terminal 2 and ground
Voltage between FPCM terminals 7 and 4	6.6 ~ 7.0 V	0 ~ 1 V	-
	8.8 ~ 9.2 V	Approx. 4	0 ~ 1 V
	Battery voltage	Approx. 4	Approx. 4

**5-2 INJECTOR SYSTEM INSPECTION**  
**CONTROL CIRCUIT DIAGRAM RB26DETT ENGINE**

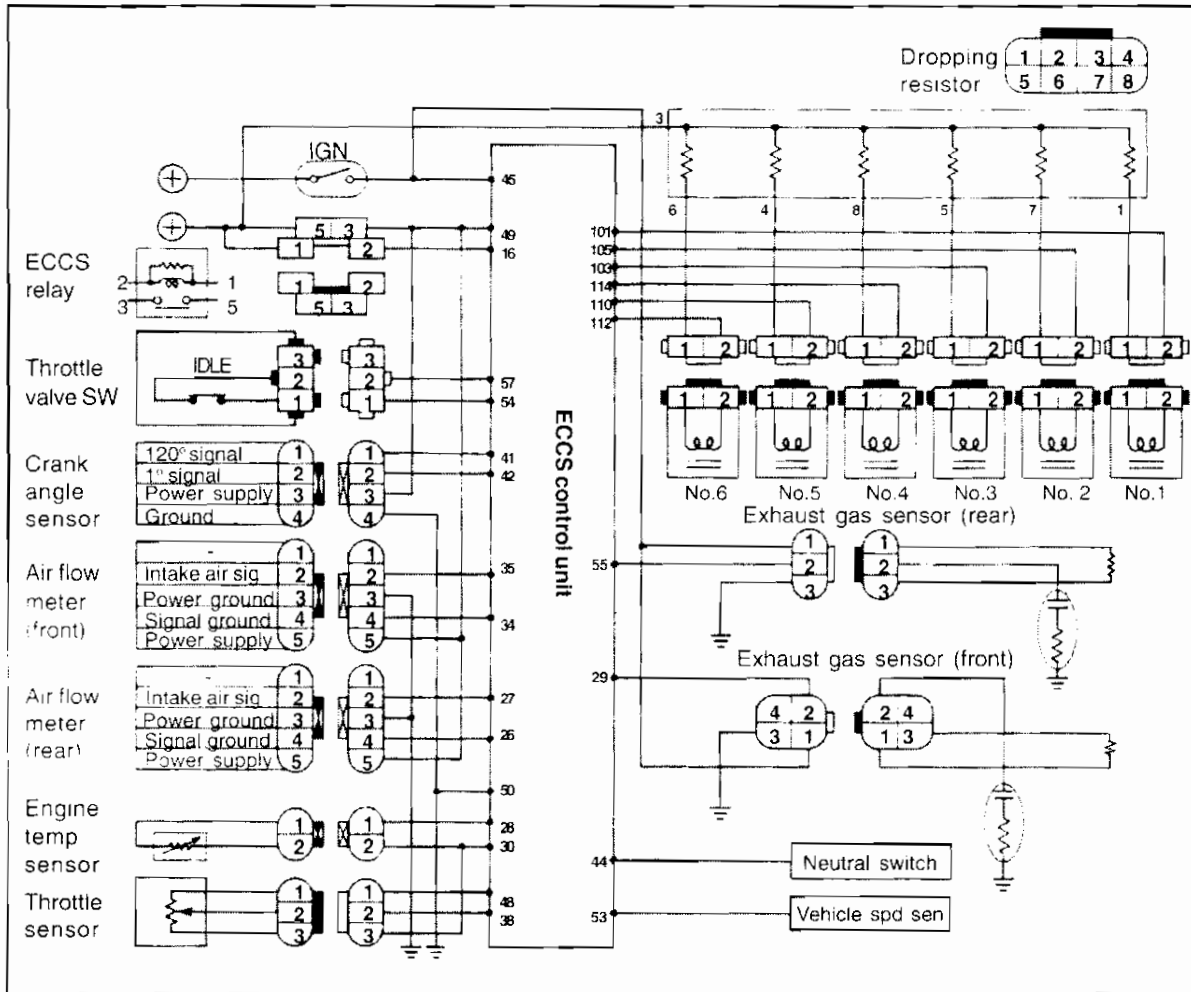

**[CONTROL DESCRIPTION]**

<b>Input signal</b>	<b>Terminal No.</b>	<b>Control description</b>	<b>Remarks</b>
Crank angle sensor 120° signal 1° signal	41, 51, 42, 52	Determines injector timing. Reads engine speed.	-
Air flow meter intake air quantity signal	27, 35	Detects intake air quantity and determines basic injection quantity (injection pulse width) based on engine load.	Fail-safe function activated when disconnected.
START signal	43	Increase fuel quantity when starting. Determines injection quantity when starter SW is ON.	-
Engine temperature signal	28	Performs injection increase according to engine temperature. Fuel cut range changes according to engine temperature.	Fail-safe activated when short-circuit or disconnection occurs.
Exhaust gas sensor signal	29, 55	Injection pulse width control according to air-fuel ratio feedback.	According to control block condition.
Throttle valve SW (Idle connection point)	54	-	Activated when throttle sensor damage occurs.
Throttle sensor	38	Fuel cut during deceleration. Flow correction during acceleration or deceleration. Interrupt injection. Idle judgement	-
Vehicle speed sensor	53	Fuel cut interrupts speed and fuel cut at 0 km/h vehicle speed.	-
Battery voltage	49	Injection pulse width correction.	-
Intake air temperature sensor	36	Detects intake air quantity temperature and corrects injection pulse width.	-

Injector system trouble diagnosis flowchart RB26DETT ENGINE

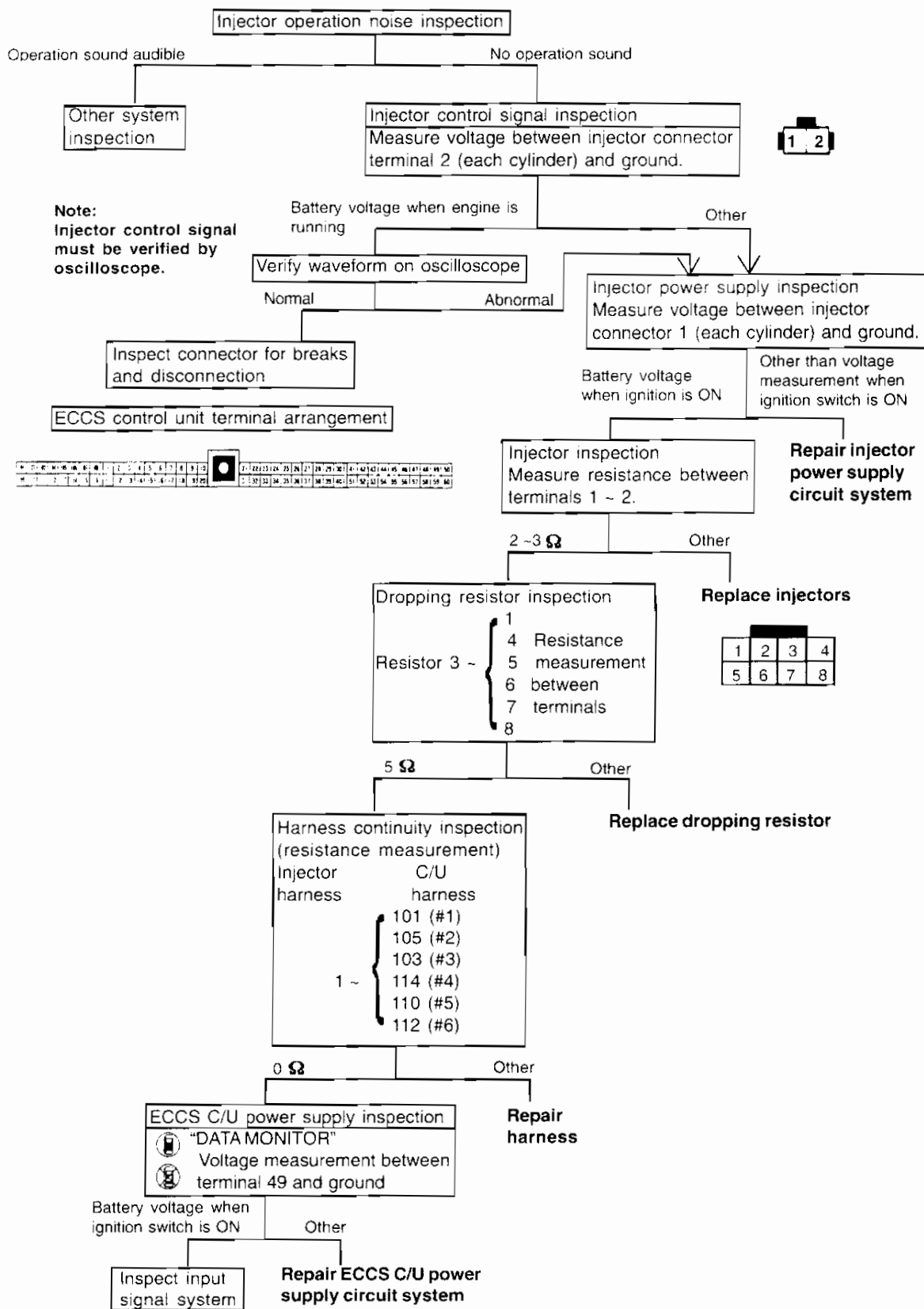



ACTUATOR SYSTEM INSPECTION

RB20E / DE / DET ENGINE

[CONTROL DESCRIPTION]

Input signal	Terminal No.	Control description	Remarks
Crank angle sensor 120° signal 1° signal	9, 19 (41, 51) 20, 10 (42, 52)	Determines injector timing. Reads engine speed.	-
Air flow meter intake air quantity signal	3 (27)	Detects intake air quantity and determines basic injection quantity (injection pulse width) based on engine load.	Fail-safe function activated when disconnected.
START signal	23 (43)	Increase fuel quantity when starting. Determines injection quantity when starter SW is ON.	-
Engine temperature sensor signal	5 (28)	Performs injection increase according to engine temperature. Fuel cut range changes according to engine temperature.	Fail-safe activated when short-circuit or disconnection occurs.
Exhaust gas sensor signal	6 (29)	Injection pulse width control according to air-fuel ratio feedback.	According to control block condition.
Throttle valve SW (Idle connection point)	32 (57)	Deceleration fuel cut according to ON signal. Acceleration increase when ON goes to OFF.	-
Throttle sensor	7 (38)	Flow correction during acceleration or deceleration. Interrupt injection.	-
Vehicle speed sensor	21 (53)	Fuel cut interrupts speed and fuel cut at 0 km/h vehicle speed.	-
Battery voltage	27 (49)	Injection pulse width correction.	-

( ) RB20DE / DET



Injector system trouble diagnosis flowchart RB20E / DE / DET ENGINE

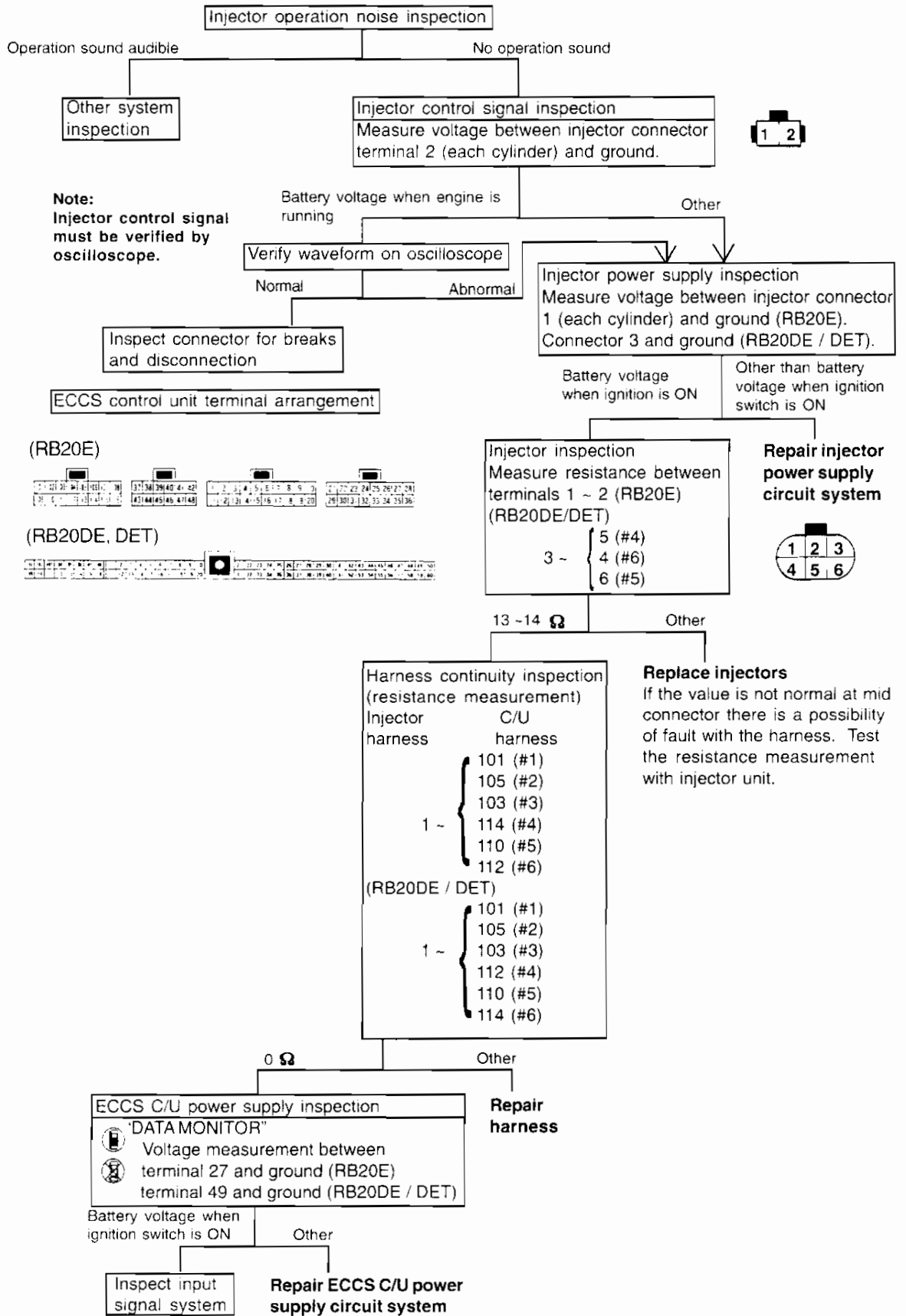

## ACTUATOR SYSTEM INSPECTION

RB26DETT / RB20E / DE / DET ENGINE

- Use "POWER BALANCE" in the CONSULT active test mode to check the idle speed variation and check the injector operation.



◆ ACTIVE TEST ◆					
POWER BALANCE					
MONITOR					
CAS.RPM (POS)		950rpm			
AIR FLOW METER		1.1 U			
AAC VALVE		25%			
1	2	3	4	TEST	
5	6			START	

**Caution:**

Do not perform test while driving.

### (1) Injector control signal and power inspection [Injector connector]



- Disconnect the injector connectors and measure the voltage between the following terminals and the ground.

#### RB26DETT

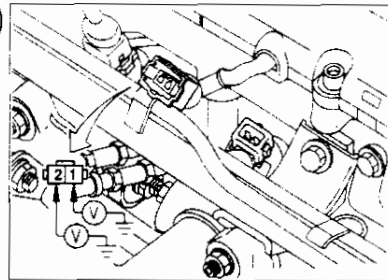

Engine	RB26DETT		RB20E / RB20DE / DET	
<b>Condition</b>	Between harness terminal 2 and ground	Between harness terminal 1 and ground	Between harness terminal 2 and ground	Between harness terminal 1 and ground
<b>Ignition switch ON</b>	Battery voltage	Battery voltage	Battery voltage	Battery voltage
<b>Cranking engine</b>	Approx. 10V	Approx. 10V	Approx. 10V	Approx. 10V
<b>Engine running</b>	The voltage decreases as the engine speed increases (approx. 0.2V decreases for each 2,000rpm of engine speed increase)		-	-

- Inspection can be carried out at mid point connector for No. 4, 5 & 6 cylinder and power supply for RB20DE & DET engines.

Engine	RB20DE / DET	
<b>Condition</b>	Control circuit Between harness terminal 4, 5, 6 and ground	Power supply circuit Between harness terminal 3 and ground
<b>Ignition switch ON</b>	Battery voltage	Battery voltage
<b>Cranking engine</b>	Approx. 10V	Approx. 10V
<b>Engine running</b>	The voltage decreases as the engine speed increases (approx. 0.2V decreases for each 2,000rpm of engine speed increase)	

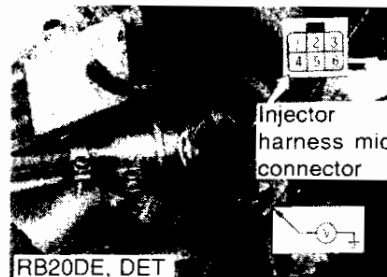
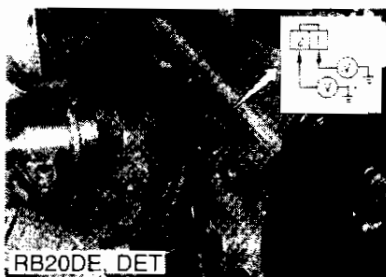

[ECCS control unit connectors]

Engine	RB26DETT / RB20E / DE / DET	
Condition	Control circuit	Power supply circuit
	Between ECCS C/U terminals 101, 103, 105, 110, 112, 114 and ground	ECCS C/U terminal 109 and ground
Ignition switch ON	Battery voltage	Battery voltage
Cranking engine	Approx. 10V	Approx. 10V
Engine running	The voltage decreases as the engine speed increases (approx. 0.2V decreases for each 2,000rpm of engine speed increase)	

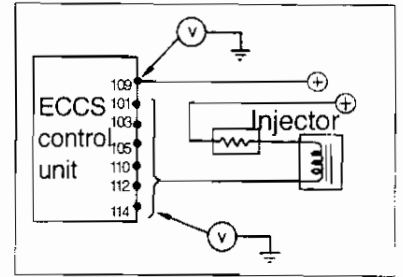

(2) ECCS control unit power supply inspection

- Refer to fuel pump system [EN3, 5, 5 - 1]

(3) Harness continuity inspection

- Disconnect the control unit and injector connectors and measure the resistance between the following terminals.

Measurement location		Engine
ECCS C/U harness	Injector harness terminal 2	RB20E / DE / DET / RB26DETT
Terminal 101 (101) [101]	TO No. 1 cylinder	0 Ω
Terminal 110 (105) [105]	TO No.2 cylinder	
Terminal 103 (103) [103]	TO No.3 cylinder	
Terminal 112 (112) [114]	TO No.4 cylinder	
Terminal 105 (110) [110]	TO No.5 cylinder	
Terminal 114 (114) [112]	TO No.6 cylinder	

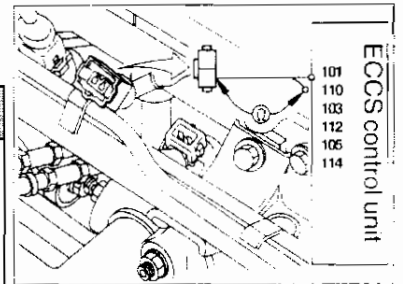

( ) RB20DE / DET [ ] RB26DETT

[RB26DETT]

- Disconnect the harness connector from the injector and dropping resistor and measure the resistance between the following terminals.

Measurement location		Engine
Dropping resistor harness	Injector harness terminal 1	RB26DETT
Terminal 1	TO No. 1 cylinder	0 Ω
Terminal 4	TO No. 5 cylinder	
Terminal 5	TO No. 3 cylinder	
Terminal 6	TO No. 6 cylinder	
Terminal 7	TO No. 2 cylinder	
Terminal 8	TO No. 4 cylinder	

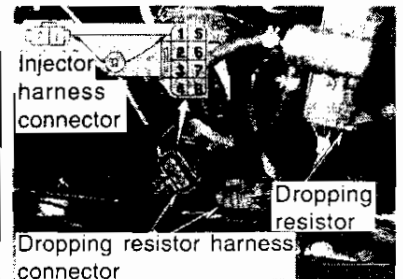

## ACTUATOR SYSTEM INSPECTION

RB26DETT / RB20E / DE / DET ENGINE

- Inspection can be carried out at mid point connector for No. 4, 5 & 6 cylinder for RB20DE & DET engines.

Measurement location		Engine
ECCS C/U harness      Mid point connector harness		RB20DE / DET
Terminal 112 TO	Terminal 5 (No. 4 cylinder)	0 Ω
Terminal 110 TO	Terminal 6 (No. 5 cylinder)	
Terminal 104 TO	Terminal 4 (No. 6 cylinder)	

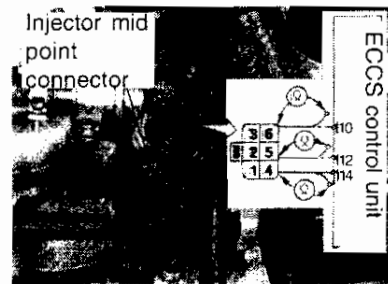

### (4) Injector inspection

- Disconnect the injector connector and measure the resistance between the terminals for each injector.

Measurement location	RB26DETT	RB20E / DE / DET
Between injector terminals 1 and 2 (for all cylinder)	2 ~ 3 Ω	13 ~ 14 Ω

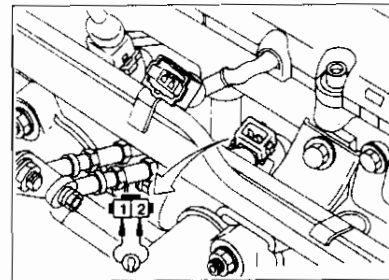

### (RB20DE / DET)

- Disconnect the injector harness mid connector and measure the resistance between the following terminals for resistance.

Measurement location		RB20DE / DET
No. 4 cylinder	Between injector terminals 3 and 5	13 ~ 14 Ω
No. 5 cylinder	Between injector terminals 3 and 6	
No. 6 cylinder	Between injector terminals 3 and 4	

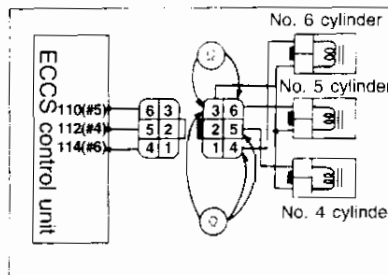

### (5) Dropping resistor

- Disconnect the dropping resistor connector and measure the resistance between the following terminals.

Measurement location		RB20DETT
Dropping resistor 3 ~	Terminal 1	5 Ω
	Terminal 4	
	Terminal 5	
	Terminal 6	
	Terminal 7	
	Terminal 8	

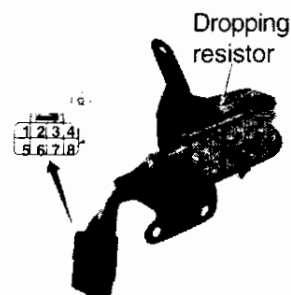

**5-2 INJECTOR SYSTEM INSPECTION  
CONTROL CIRCUIT DIAGRAM CA18i ENGINE**

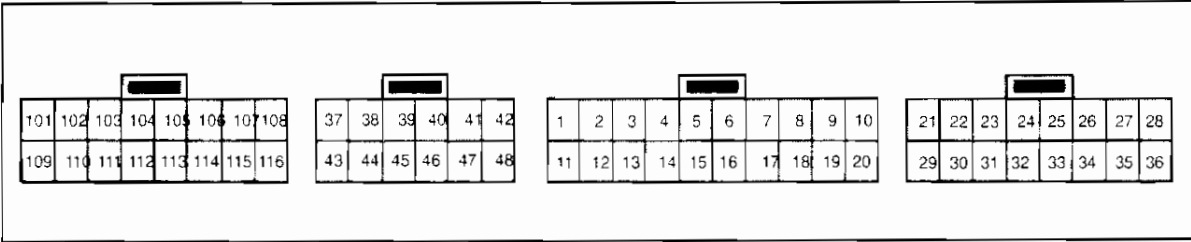
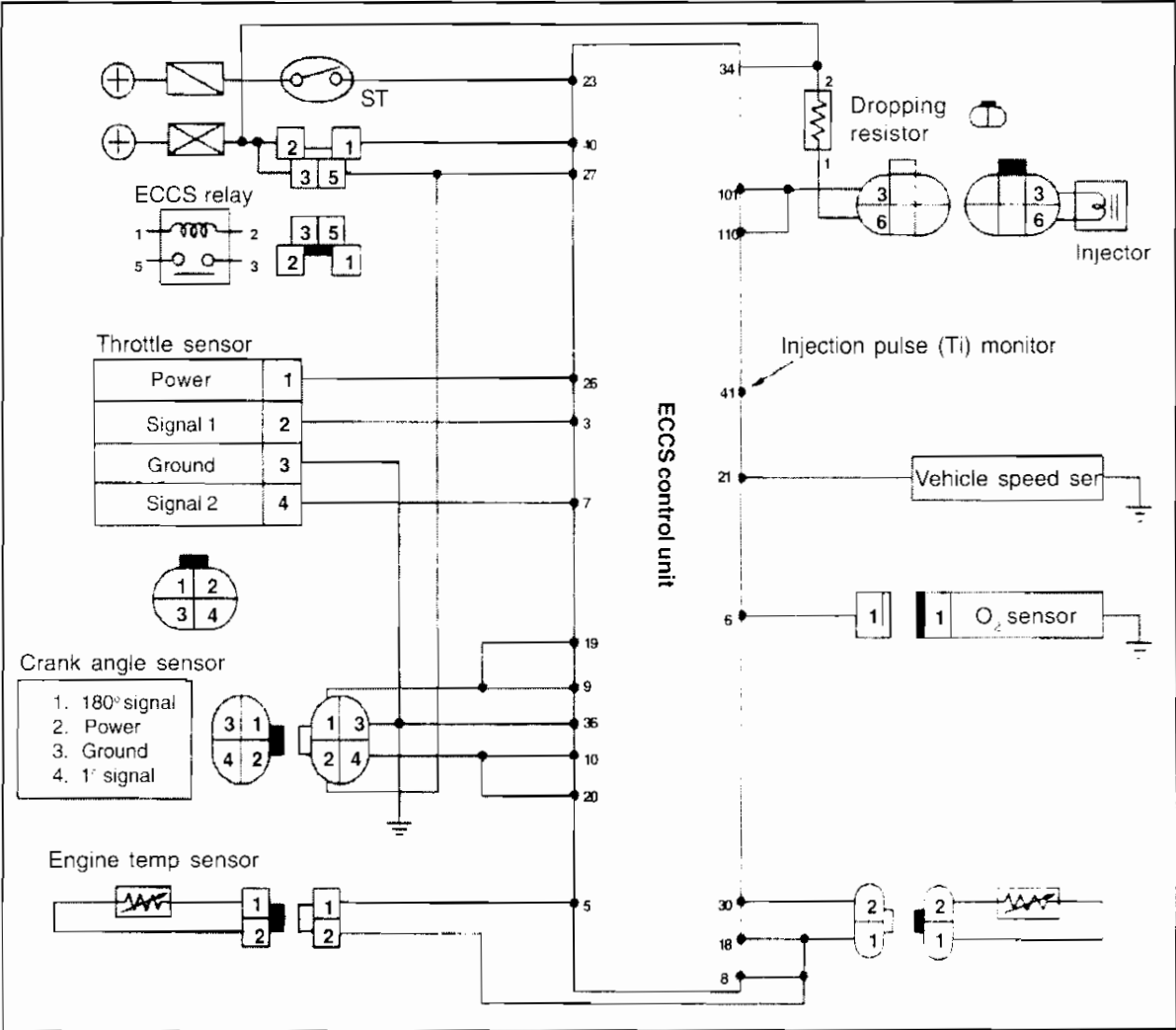

**[CONTROL DESCRIPTION]**

<b>Input signal</b>	<b>Terminal No.</b>	<b>Control description</b>	<b>Remarks</b>
Crank angle sensor 120° signal 1° signal	9, 19, 20, 10	Reads engine speed.	-
Air flow meter intake air quantity signal	3	Detects intake air quantity and determines basic injection quantity (injection pulse width) based on engine load.	Fail-safe function activated when disconnected.
START signal	23	Increase fuel quantity when starting. Determines injection quantity when starter SW is ON.	-
Engine temperature sensor signal	5	Performs injection increase according to engine temperature. Fuel cut range changes according to engine temperature.	Fail-safe activated when short-circuit or disconnection occurs.
Exhaust gas sensor signal	6	Injection pulse width control according to air-fuel ratio feedback.	According to control block condition.
Throttle sensor	3, 7	Deceleration fuel cut according to throttle valve idle position signal . Acceleration increase when ON goes to OFF.	2 system type
Vehicle speed sensor	21	Fuel cut at prohibited vehicle speed.	-
Battery voltage	27	Injection pulse width correction.	-

Injector system trouble diagnosis flowchart CA18i ENGINE

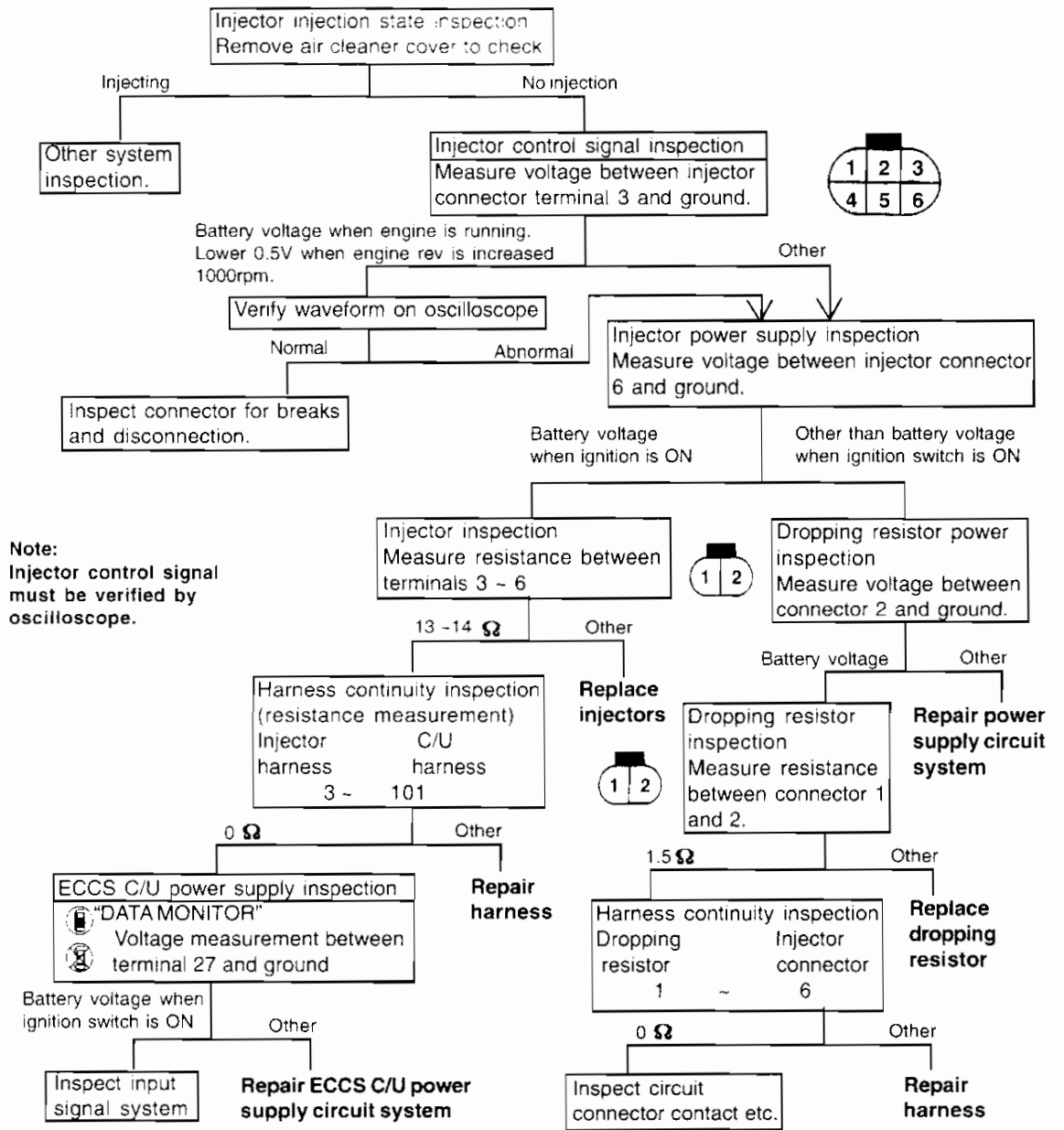

ECCS control unit terminal arrangement

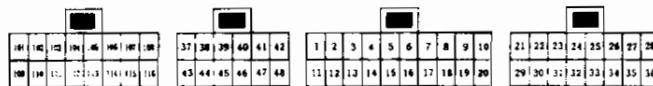

CA18i ENGINE

**(1) Injector control signal and power inspection**

- Disconnect the injector connectors and measure the voltage between the following terminals and the ground.

Engine	CA18i	
Condition	Control circuit	Power supply circuit
	Between injector harness terminal 3 and ground	Between injector harness terminal 6 and ground
Ignition switch ON	0V	Battery voltage

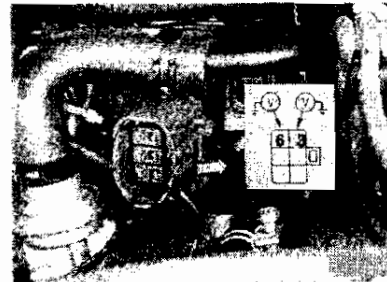

- Connect injector connector.

Engine	CA18i
Condition	Control circuit
	Between ECCS C/U harness terminal 101 and ground
Ignition switch ON	Battery voltage
Cranking & while engine running	Battery voltage (decreases 0.5V for engine speed increase of 1000rpm)

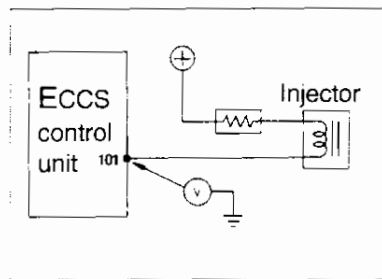

Note:

For accurate data use oscilloscope.

**(2) ECCS control unit power supply inspection.**

- Refer to fuel pump system [EN3, 5, 5 - 1]
- Measure the voltage between the following terminals and ground with ECCS control unit connector connected.

Condition	Between ECCS C/U harness terminal 27 and ground	Between ECCS C/U harness terminal 40 and ground
Ignition switch OFF position	0V	Battery voltage
Ignition switch ON position	Battery voltage	0V

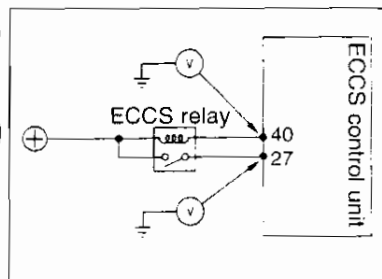

**(3) Harness continuity inspection**

- Disconnect ECCS control unit and injector connector and measure the resistance between the following terminals.

Measurement location	CA18i
Between ECCS C/U injector harness terminal 101 and 3	0 Ω

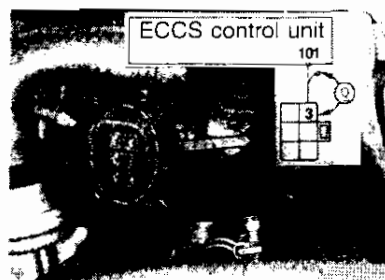



**(4) Injector inspection**

- Disconnect injector connector and measure the resistance between the following terminals.

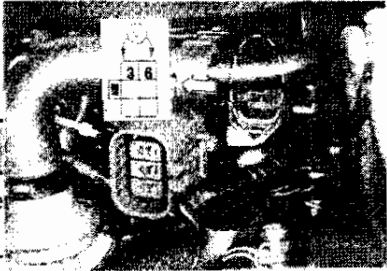

Measurement location
Between injector harness terminals 3 and 6

**(5) Injection pulse monitor (Ti monitor) signal inspection**

- Measure the voltage between the following terminals with ECCS control unit connected.

Condition	Between ECCS C/U terminal 41 and ground
Ignition switch in ON position	Battery voltage
Cranking or engine running	Battery voltage (approx. 0.5 V decreases for each 100rpm of engine speed increase).

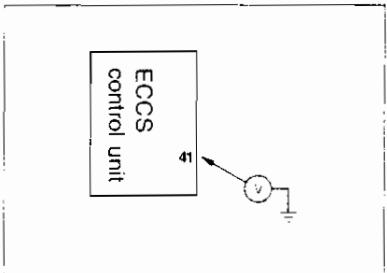

**(Reference) Inspection using the Oscilloscope**

- Injection pulse monitor (Ti monitor) is a result of the injection pulse width within the ECCS control unit and it may differ slightly with actual injector waveform (about the same for CA18i) but the pulse width is same.
- If the waveform is abnormal and the Ti monitor is normal, the ECCS control unit and the input system is normal and there is a possibility of fault with the injector circuit or the injector main body.

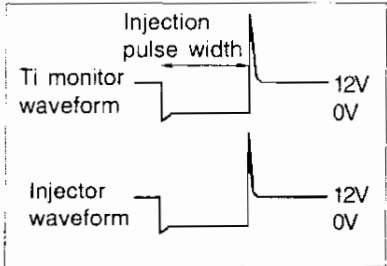

**5-3 IGNITION SYSTEM INSPECTION  
CONTROL CIRCUIT DIAGRAM RB26DETT ENGINE**

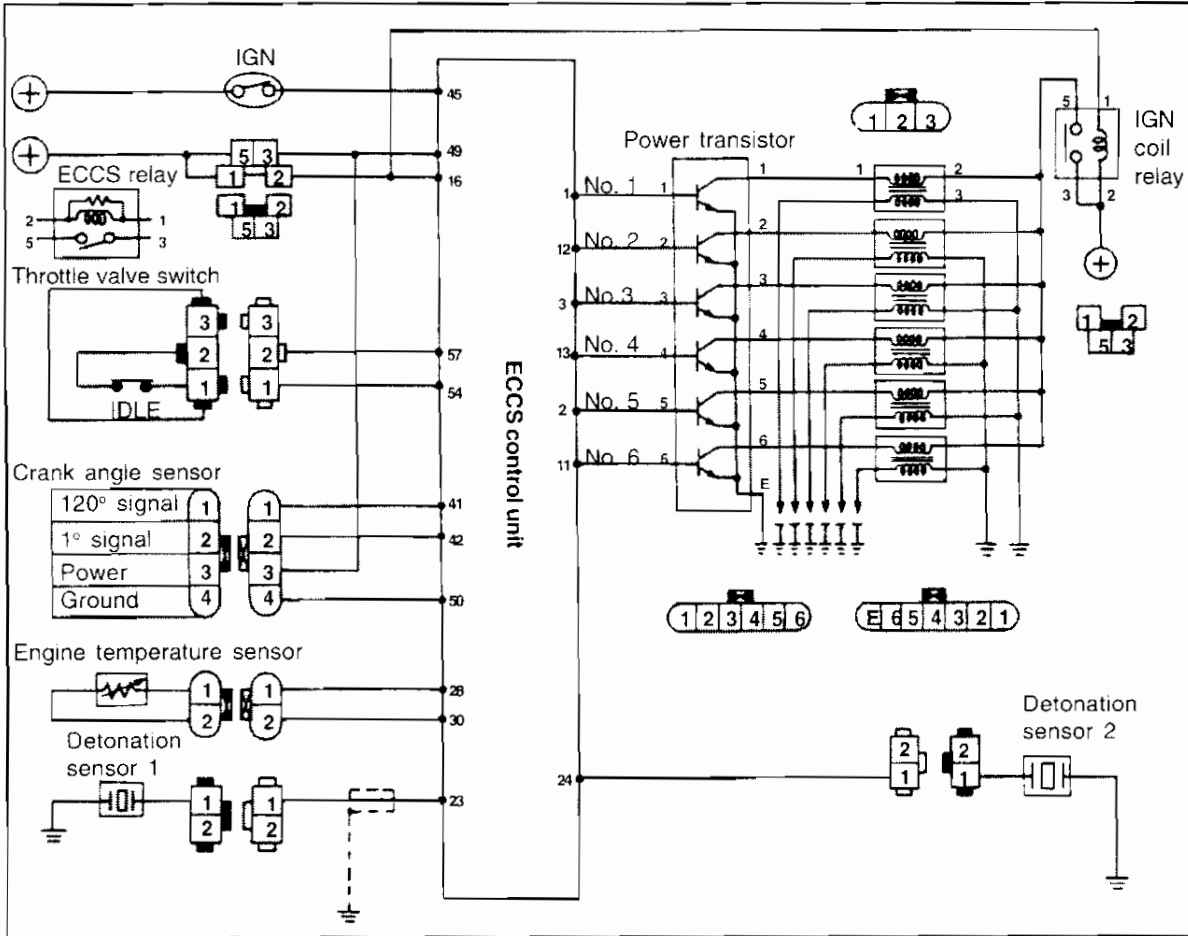

**[Control description]**

Input signal	Terminal No.	Control description	Remarks
Crank angle sensor 120° signal	41, 51	Ignition timing start point.	The ignition can not be performed if there is an instantaneous break in the 120° signal.
Crank angle sensor 1° signal	42, 52	Ignition timing count. The ignition timing is set according to the map indicated by 120° signal.	The ignition can not be performed if there is an instantaneous break in the 1° signal.
Engine temperature sensor	28	Changes injection timing according to engine temperature. Control for low and high engine temperature conditions.	Fail-safe is performed when there is a short-circuit or disconnecting, 20°C at starting, gradually increasing to 80°C
Throttle valve switch (Idle connection point)	54	-	Activated when throttle sensor damage occurs. Idle judgement backup.
Throttle sensor	38	Fuel cut during deceleration. Flow correction during acceleration or deceleration. Interrupts injection. Idle judgement.	-
"START" signal	43	Controls ignition timing when cranking engine.	-
Detonation sensor	23, 24	Detects detonation and changes ignition timing.	Fail-safe is activated if short-circuit or disconnection occurs.

Ignition system trouble diagnosis flowchart RB26DETT ENGINE

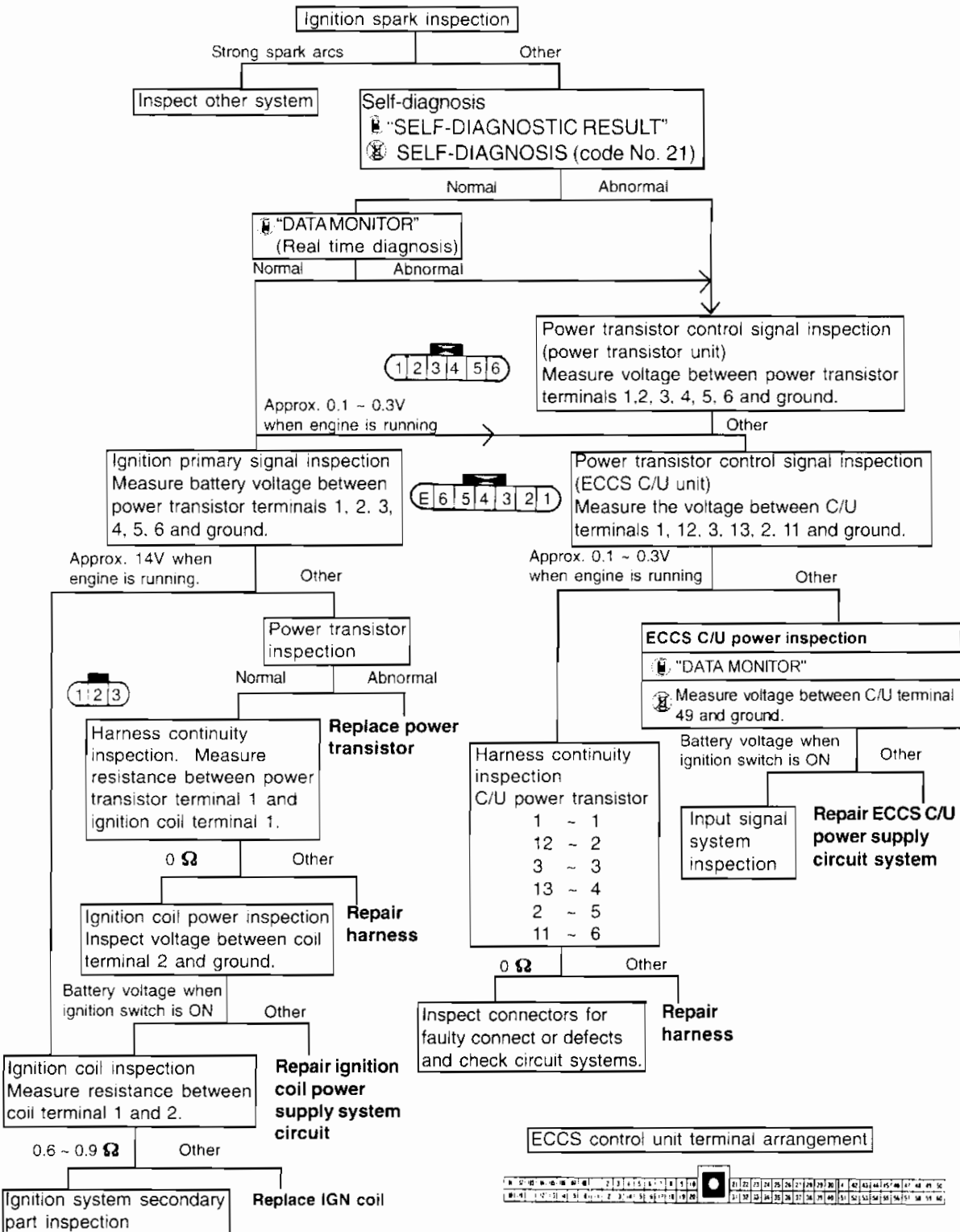

**5-3 IGNITION SYSTEM INSPECTION**  
**CONTROL CIRCUIT DIAGRAM RB20E / DE / DET ENGINE**

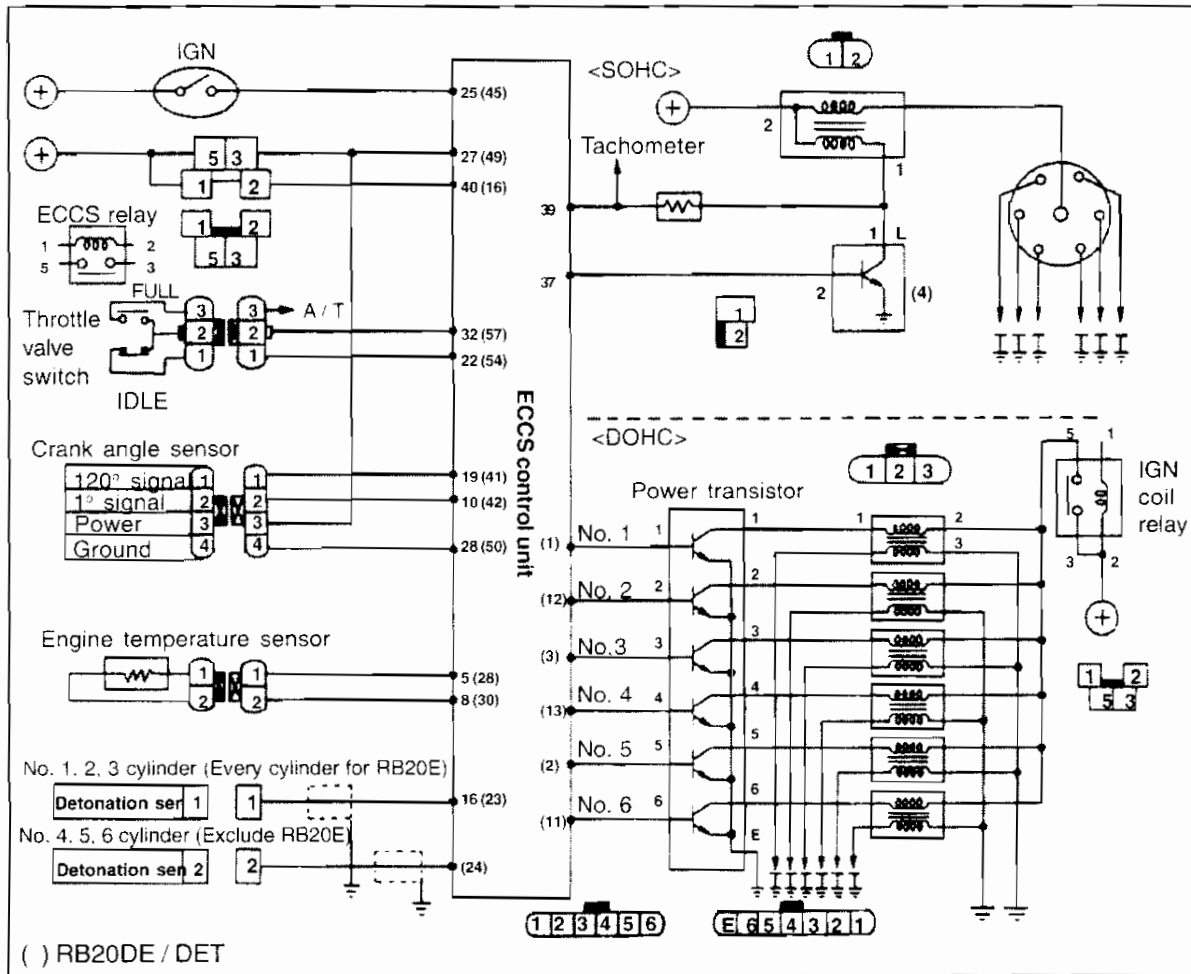

**[Control description]**

Input signal	Terminal No.	Control description	Remarks
Crank angle sensor 120° signal	19 (41)	Ignition timing start point.	The ignition can not be performed if there is an instantaneous break in the 120° signal.
Crank angle sensor 1° signal	10 (42)	Ignition timing count. The ignition timing is set according to the map indicated by 120° signal.	The ignition can not be performed if there is an instantaneous break in the 1° signal.
Engine temperature sensor	5 (28)	Changes injection timing according to engine temperature. Control for low and high engine temperature conditions.	Fail-safe is performed when there is a short-circuit or disconnecting, 20°C at starting, gradually increasing to 80°C
Throttle valve switch	32 (57)	Controls ignition timing when idling and ignition switch is ON.	-
"START" signal	23 (43)	Controls ignition timing when cranking engine.	-
Detonation sensor	16 (23, 24)	Detects detonation and changes ignition timing.	Fail-safe is activated if short-circuit or disconnection occurs.

Ignition system trouble diagnosis flowchart RB20E / DE / DET ENGINE

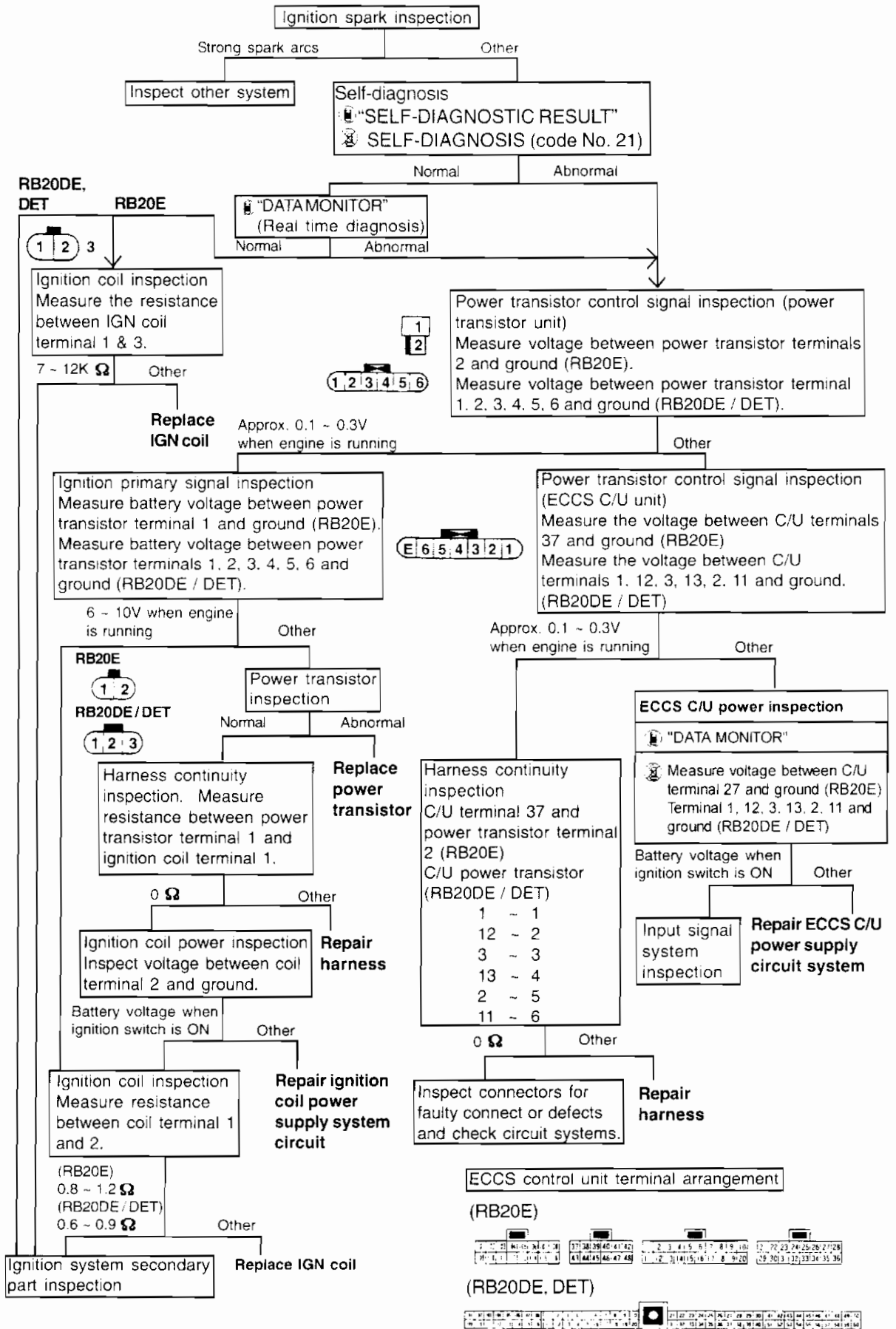

**5-3 IGNITION SYSTEM INSPECTION  
CONTROL CIRCUIT DIAGRAM CA18i ENGINE**

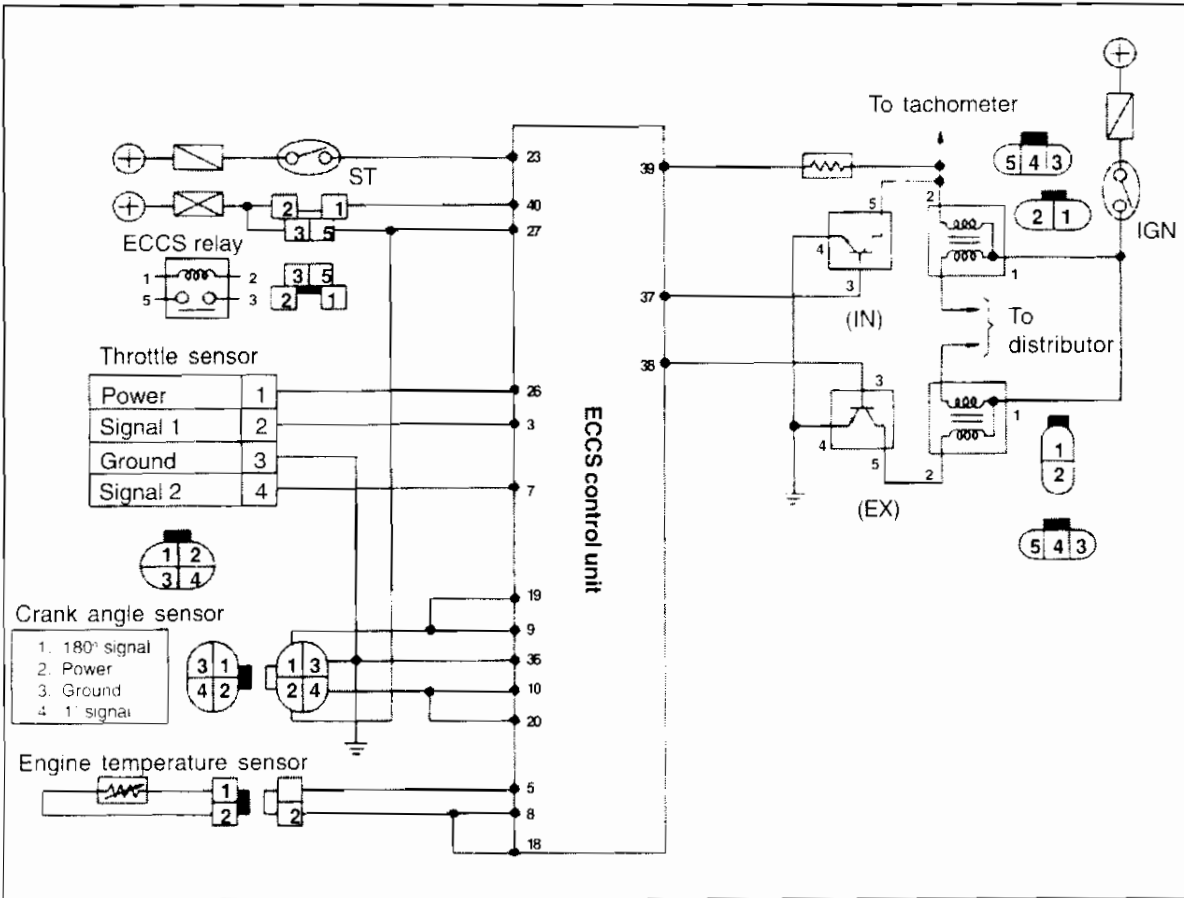

**[Control description]**

Input signal	Terminal No.	Control description	Remarks
Crank angle sensor 180° signal	9	Ignition timing start point.	The ignition can not be performed if there is an instantaneous break in the 180° signal.
Crank angle sensor 1° signal	10	Ignition timing count. The ignition timing is set according to the map indicated by 180° signal.	The ignition can not be performed if there is an instantaneous break in the 1° signal.
Engine temperature sensor	5	Changes injection timing according to engine temperature. Control for low and high engine temperature conditions.	Fail-safe is performed when there is a short-circuit or disconnecting.
Throttle switch	3. 7	Controls ignition timing when idling.	-
"START" signal	23	Controls ignition timing when cranking engine.	-

**Ignition system trouble diagnosis flowchart CA18i ENGINE**

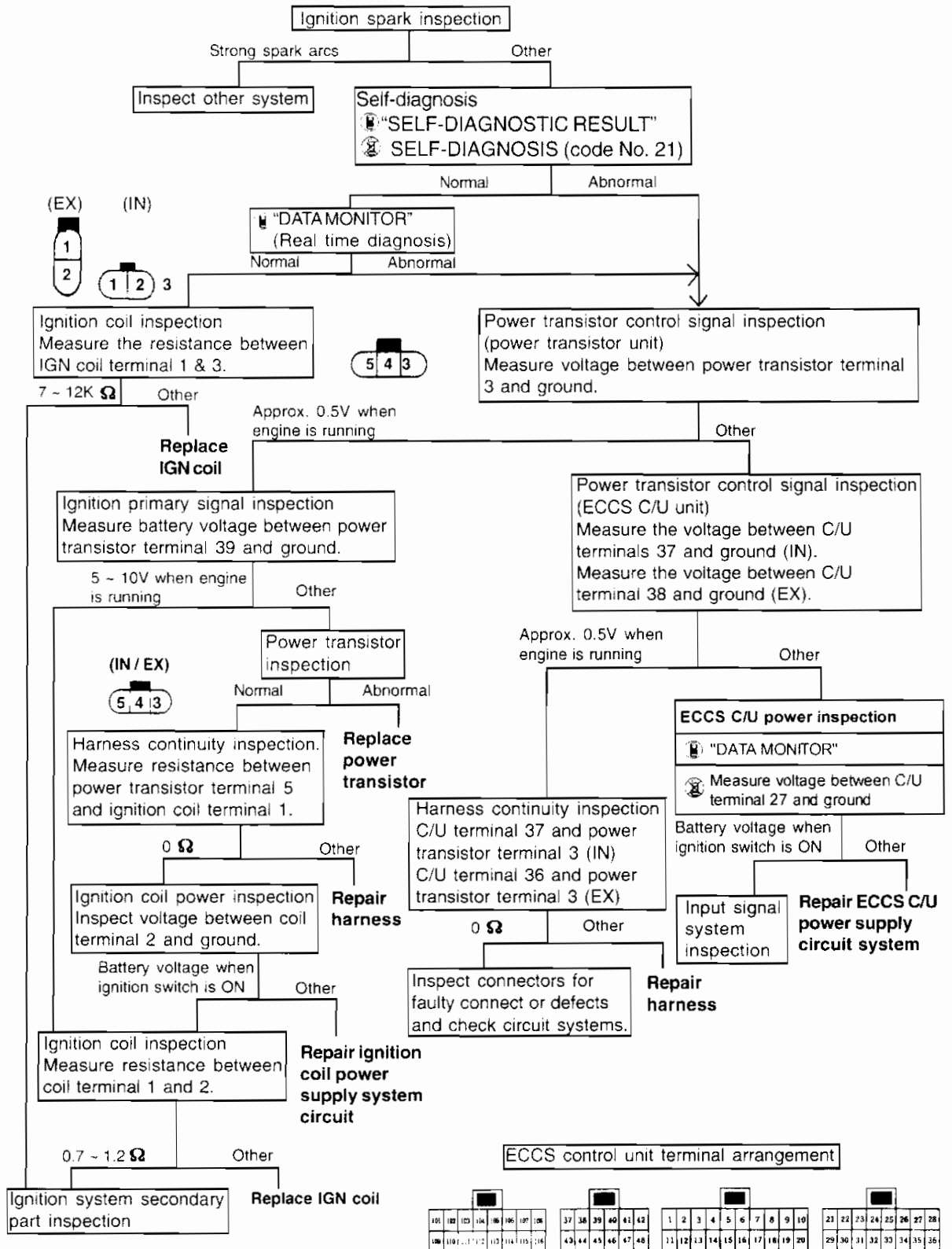

**(1) Self-diagnosis**

- Check faulty system name in "SELF-DIAGNOSTIC RESULT" mode when the ignition switch is ON and engine is cranking.
- When there is abnormal output, inspect assumed locations in the following sequence.

**Power transistor (short) - ECCS harness (short) - ECCS control unit**

- Place ignition switch to ON position.
- Perform diagnosis mode selection procedure with the diagnosis connector in the vehicle. Check the code number of the faulty system displayed by the flashing exhaust gas temperature warning lamp on the instrument panel (see EN3, 2, 2-2 (2)).

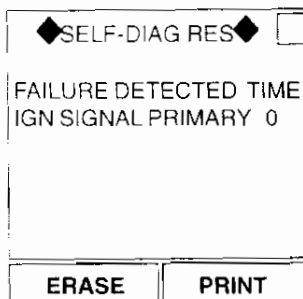

**(2) Power transistor control signal inspection**

- Measure the battery voltage between the following connectors and the ground when the ECCS control unit connectors are connected.

**RB26DETT**

Engine	RB26DETT
Measurement locations	Between ECCS C/U terminals 1, 2, 3, 11, 12, 13 and ground
Cranking	0.2 ~ 0.3V
Idling	0.2 ~ 0.3V
2,500 rpm	Approx. 0.4V

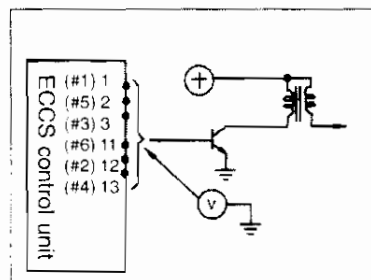

**RB20E / DE / DET**

Engine	RB20E	RB20DE / DET
Measurement locations	Between ECCS C/U terminal 37 and ground	Between ECCS C/U terminals 1, 2, 3, 11, 12, 13 and ground
Cranking	0.2 ~ 0.3V	-
Idling	0.2 ~ 0.3V	0.2 ~ 0.3V
2,500 rpm	Approx. 1.0V	Approx. 0.4V

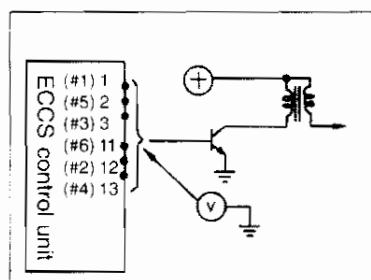

**CA18i**

Engine	CA18i	
Measurement locations	Between ECCS C/U terminal 37 and ground	Between ECCS C/U terminal 38 and ground
Cranking	Approx. 0.5V	Approx. 0.5V
Idling	Approx. 0.5V	Approx. 0.5V
2,500 rpm	Approx. 1.0V	Approx. 1.0V

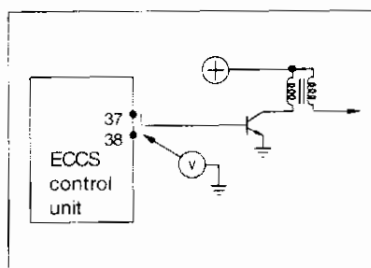



**(3) Ignition primary voltage signal inspection  
CA18i & RB20E**

- Measure the battery voltage between the following terminals when ECCS control unit connector connected.

Engine	CA18i	RB20E
Measurement locations	Between ECCS C/U terminal 39 and ground	
Cranking	6 ~ 8V	5 ~ 10V
Idling	Approx. 10V	Battery voltage
2,500 rpm	Approx. 8.5V	Lower than battery voltage

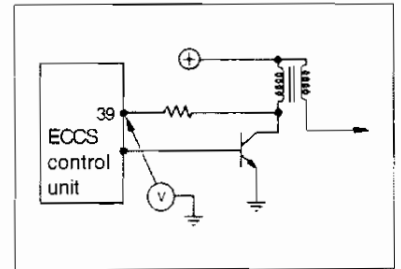

**RB20DE / DET & RB26DETT**

- Measure the primary voltage of coil side connector of power transistor.

Engine	RB26DETT & RB20DE / DET	
Measurement locations	Between power transistor IGN coil side terminals 1, 2, 3, 4, 5, 6 and ground	Between IGN coil side terminal E and ground
Cranking	Approx. 10V	0V
Idling	Approx. 14V	0V
2,500 rpm	Approx. 14V	0V

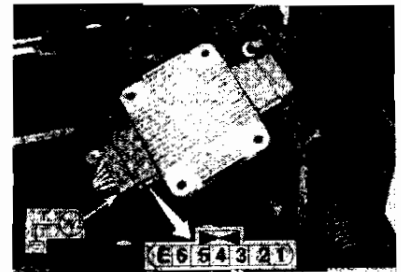

**(4) Harness continuity inspection  
CA18i & RB20E**

- Disconnect ECCS control unit and power transistor connector and measure the resistance between the following terminals.

Engine	Measurement location	
RB20E	Between ECCS C/U harness terminal 37 and power transistor terminal 2	0
CA18i	Between ECCS C/U harness terminal 37 and power transistor terminal 3	
	Between ECCS C/U harness terminal 38 and power transistor terminal 3	

**RB20E**

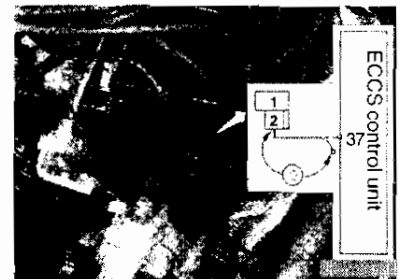

**CA18i**

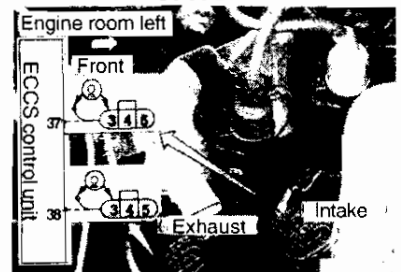

**RB20DE / DET & RB26DETT**

- Disconnect the connectors on input side of the ECCS C/U and power transistor unit, and measure the resistance between the following terminals.

Engine	Measurement location	
RB26DETT / RB20DE / DET	ECCS C/U harness Power transistor harness side between terminal 1 and terminal 1 between terminal 12 and terminal 2 between terminal 3 and terminal 3 between terminal 13 and terminal 4 between terminal 2 and terminal 5 between terminal 11 and terminal 6	0

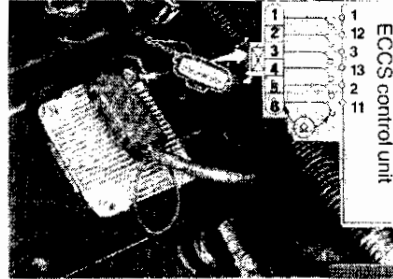

- Disconnect power transistor unit output side and ignition coil connector and measure the resistance between the following terminals.

Engine	Measurement location	
RB26DETT / RB20DE / DET	Power transistor unit harness Ignition coil connector harness (7 Polarity terminal side) (terminal 1) between terminal 1 and terminal 1 between terminal 2 and terminal 2 between terminal 3 and terminal 3 between terminal 4 and terminal 4 between terminal 5 and terminal 5 between terminal 6 and terminal 6	0

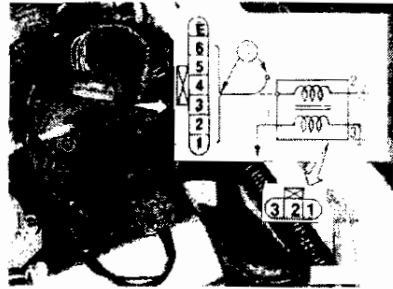

- Disconnect each ignition coil connector and measure the voltage between the following terminals.

Engine	RB26DETT / RB20DE / DET
Measurement location	Between ignition coil connector harness terminal 2 and ground
Ignition switch ON	Battery voltage

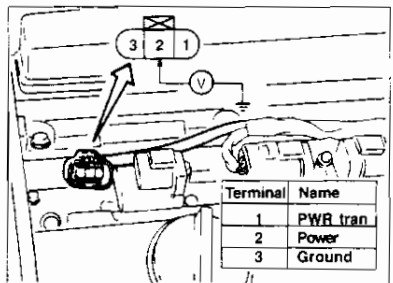

**(5) Power transistor inspection**

- Check the resistance value between all power transistor terminals with an analog circuit tester probe by changing the positive (+) and negative (-) poles.

**CA18i**

Inspection terminals and values	Example
5 - 3 +/- 0 or not $\infty \Omega < +/- \infty \Omega$	+/- 150 $\Omega$ +/- $\infty \Omega$
4 - 3 +/- 0 or not $\infty \Omega = +/-$ or not $\infty \Omega$	+/-300 $\Omega$ +/-125 $\Omega$
5 - 4 +/- 0 or not $\infty \Omega < +/- \infty \Omega$	+/-46 $\Omega$ +/- $\infty \Omega$

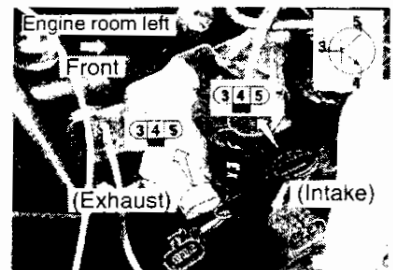

The measured value may differ between the analog tester and the digital tester.

**RB20E / DE / DET**

Inspection terminals and values	
1-3	+/- 0 or not $\infty \Omega$ < +/- $\infty \Omega$
2-3	+/- 0 or not $\infty \Omega$ = +/- 0 or not $\infty \Omega$
1-2	+/- 0 or not $\infty \Omega$ < +/- $\infty \Omega$

**RB20E**

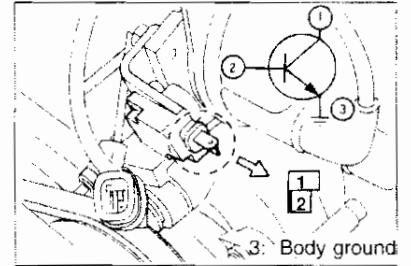

**RB20DE / DET**



**RB26DETT**

Connector	Terminal	Tester prove	Inspection value	Tester prove	Inspection value
Coil side	EEEEEE	+	0 or not	-	0 or not
C/U side	123456	-	$\infty \Omega$	+	$\infty \Omega$
Coil side	EEEEEE	+	$\infty \Omega$	-	0 or not
Coil side	123456	-	$\infty \Omega$	+	$\infty \Omega$
Coil side	123456	+	0 or not	-	$\infty \Omega$
C/U side	123456	-	$\infty \Omega$	+	$\infty \Omega$

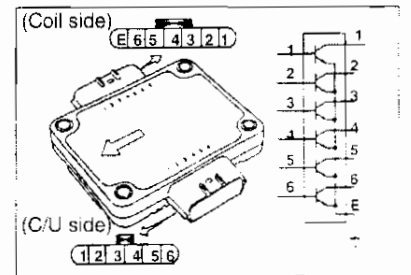

**(6) Ignition coil inspection**

- Measure primary coil resistance value.

Measurement location	RB20E	RB20DE / DET	CA18i	RB26DETT
Primary coil resistance value (1 ~ 2)	0.8 ~ 1.2	0.6 ~ 0.9	0.7 ~ 1.2	0.6 ~ 0.9
Secondary coil resistance value (1 ~ 3)	7K ~ 12K	-	7K ~ 12K	-

**RB20E**

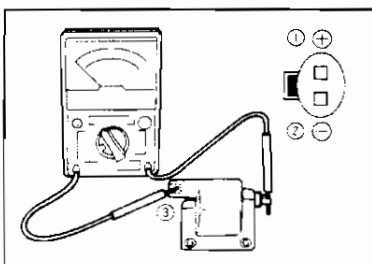

**RB20DE / DET / RB26DETT**

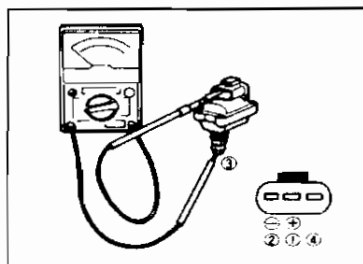

**CA18i**

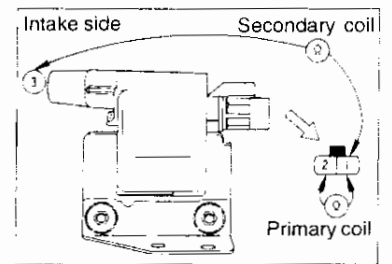

**(7) High tension cable resistance value**

- Measure the resistance of the high tension cables.

**RB20E**

Measurement location	RB20E
No. 1 cylinder	5 ~ 12K $\Omega$
No. 2 cylinder	6 ~ 15K $\Omega$
No. 3 cylinder	8 ~ 18K $\Omega$
No. 4 cylinder	8 ~ 18K $\Omega$
No. 5 cylinder	8 ~ 19K $\Omega$
No. 6 cylinder	8 ~ 19K $\Omega$
Centre cable	4 ~ 10K $\Omega$

**CA18i**

Measurement location	RB20E	
Intake side	For No. 1 cylinder	Approx. 11K $\Omega$
	For No. 2 cylinder	Approx. 11K $\Omega$
	For No. 3 cylinder	Approx. 13K $\Omega$
	For No. 4 cylinder	Approx. 11K $\Omega$
	Centre cable	Approx. 8K $\Omega$
Exhaust side	For No. 1 cylinder	Approx. 5K $\Omega$
	For No. 2 cylinder	Approx. 7K $\Omega$
	For No. 3 cylinder	Approx. 9K $\Omega$
	For No. 4 cylinder	Approx. 11K $\Omega$
	Centre cable	Approx. 7K $\Omega$

**5-4 IDLE SPEED CONTROL SYSTEM INSPECTION  
CONTROL CIRCUIT DIAGRAM RB26DETT ENGINE**

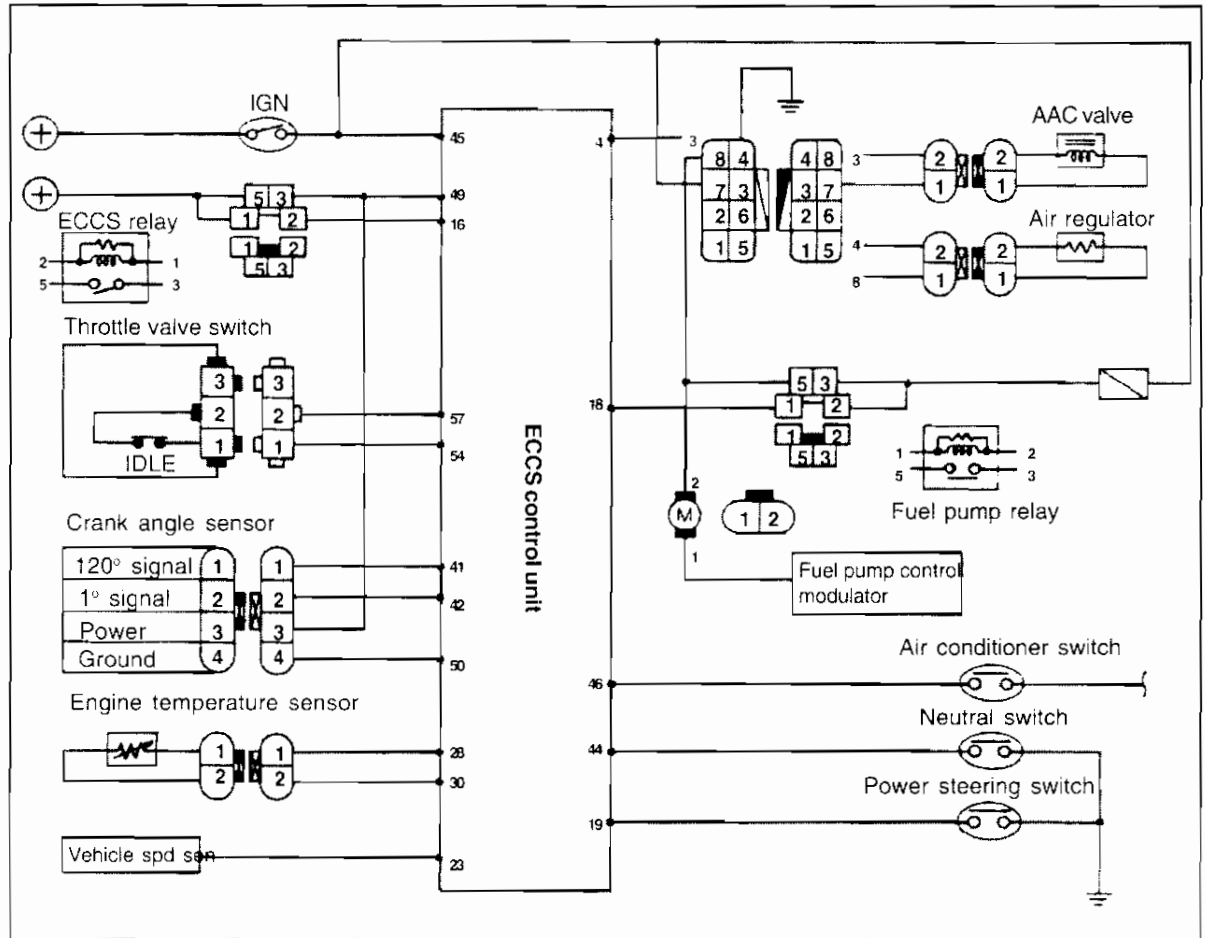

**[Control description]**

Input signal	Terminal No.	Control description
Crank angle sensor 1° signal	42, 52	Read engine speed and feedback control is performed for speed value.
Engine temperature sensor	28	Changes injection timing according to engine temperature.
Throttle valve switch (Idle connection point)	54	Operates when there is a fault with throttle sensor (idle judgement backup).
Throttle sensor	38	Fuel cut during deceleration. Flow correction during acceleration or deceleration. Interrupts injection. Idle judgement.
Vehicle speed sensor	53	Starts idle control at vehicle speed below 8km/h.
Air conditioner switch	46	After engine warms up, increase idle when air conditioning is turned ON.
Neutral switch	44	Starts idle control in neutral position.
Power steering switch	19	Increase idle speed when power steering oil pressure is too high.
Battery voltage	49	Increase idle speed when battery voltage is low (below 12V).

Idle speed control system trouble diagnosis flowchart RB26DETT ENGINE

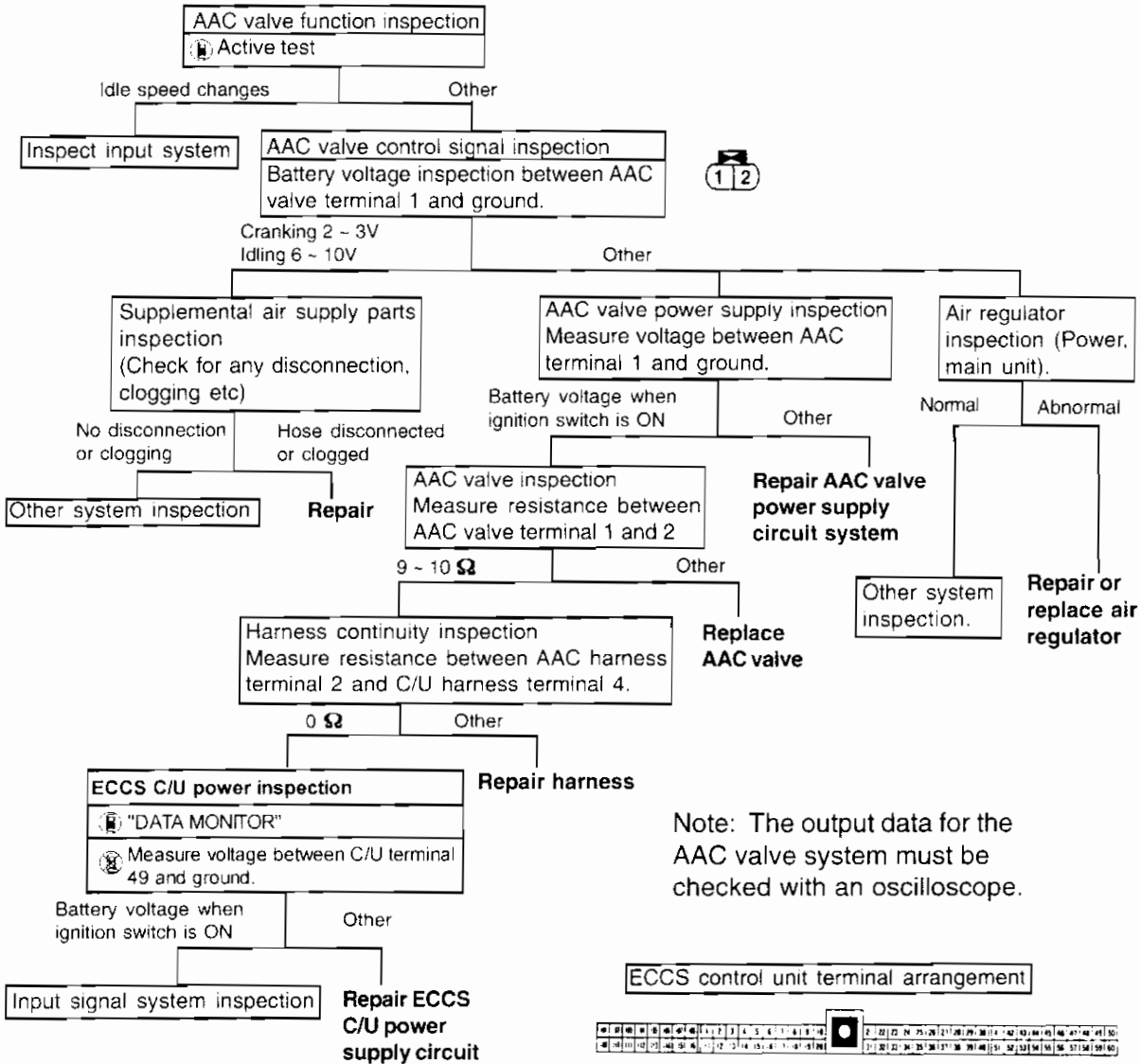

**5-4 IDLE SPEED CONTROL SYSTEM INSPECTION  
CONTROL CIRCUIT DIAGRAM RB20E / DE / DET ENGINE**

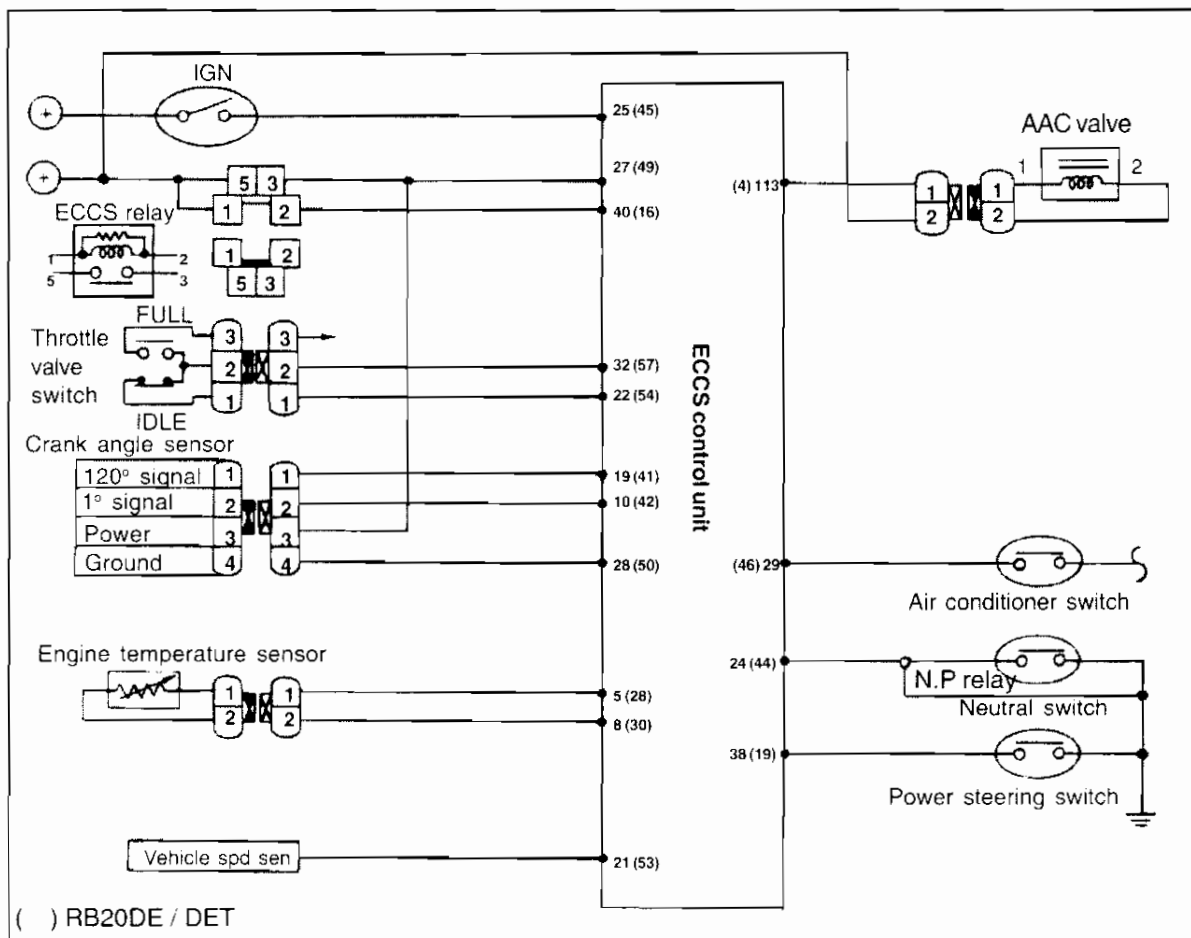

**[Control description]**

Input signal	Terminal No.	Control description
Crank angle sensor 1° signal	10. (42)	Read engine speed and feedback control is performed for speed value.
Engine temperature sensor	8, (28)	Changes injection timing according to engine temperature.
Throttle valve switch (Idle connection point)	32, (57)	Starts idle control when ON at idle contact points.
Vehicle speed sensor	21, (53)	Starts idle control at vehicle speed below 8km/h.
Air conditioner switch	29, (46)	After engine warms up, increase idle when air conditioning is turned ON.
Neutral switch	24, (44)	Starts idle control in neutral position.
Power steering switch	38, (19)	Increase idle speed when power steering oil pressure is too high.
Battery voltage	27, (49)	Increase idle speed when battery voltage is low (below 12V).

Idle speed control system trouble diagnosis flowchart RB20E / DE / DET ENGINE

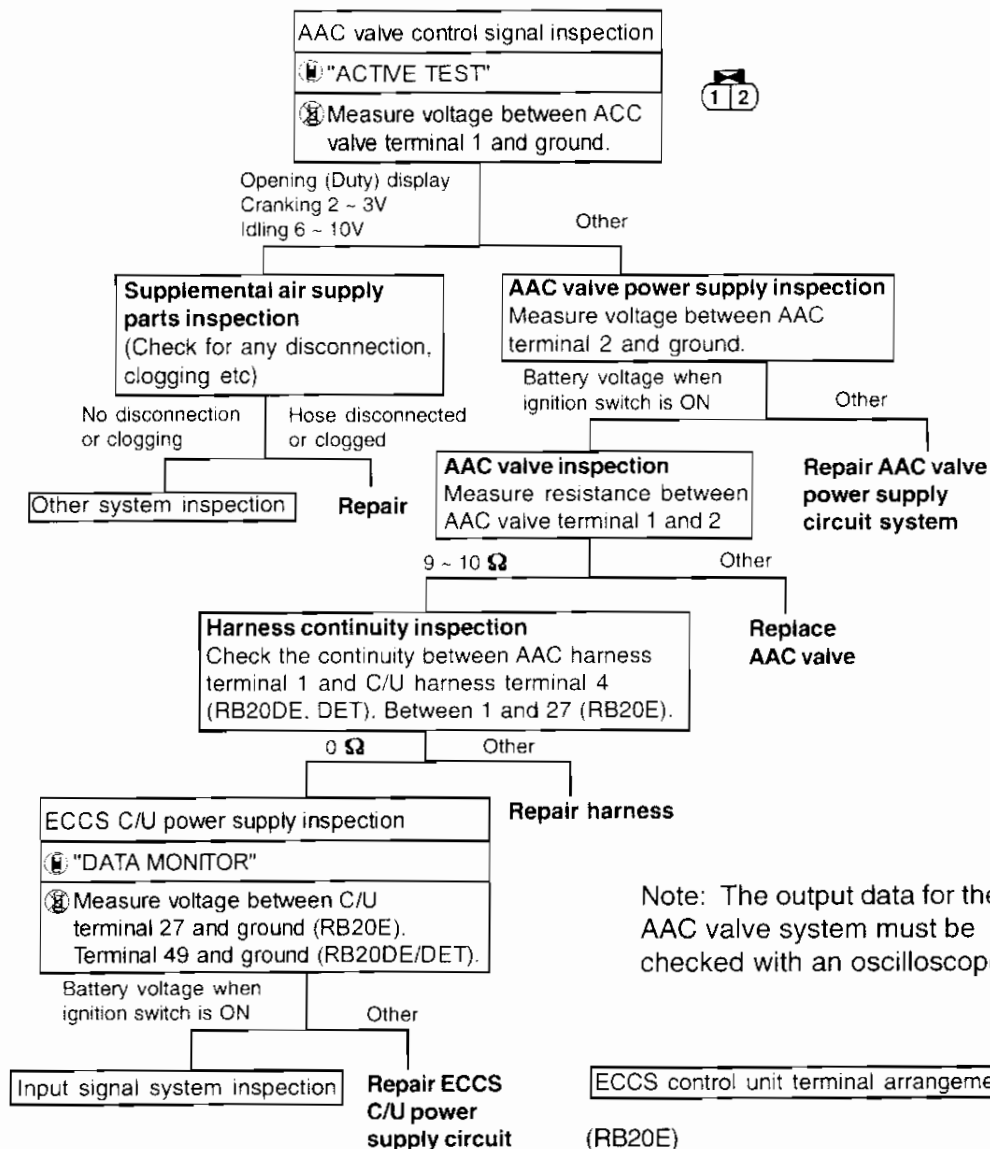

Note: The output data for the AAC valve system must be checked with an oscilloscope.

ECCS control unit terminal arrangement

(RB20E)

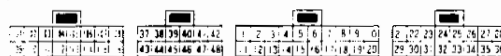

(RB20DE, DET)





**(1) AAC valve control signal inspection**

- Measure the voltage between the following terminals when ECCS control unit connector is connected.

Condition		Engine	RB20E	RB20DE / DET / RB26DETT
Measurement location			Between ECCS C/U terminal 113 and ground	Between ECCS C/U terminal 4 and ground
Ignition switch is ON			Battery voltage	Battery voltage
Cranking engine			2 ~ 3 V	2 ~ 3 V
Idling	When cold		6 ~ 7 V	6 ~ 7 V
	After warm-up		8 ~ 10V	8 ~ 10V

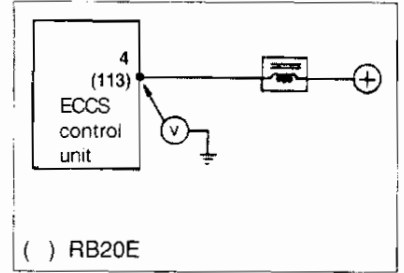

**RB26DETT**

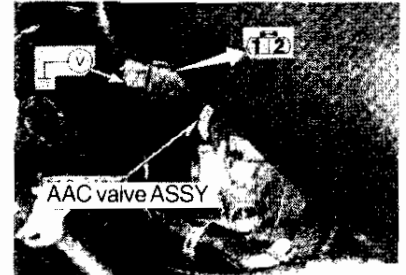

OR

**RB26DETT**

- Measure voltage between AAC valve connector terminal 2 and middle harness connector terminal 3 and ground.

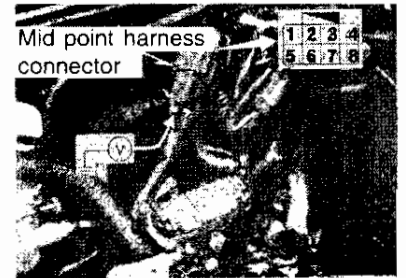

**RB20E / DE / DET**

**RB20E / DE / DET**

- Measure voltage between AAC valve connector terminal 1 and ground.

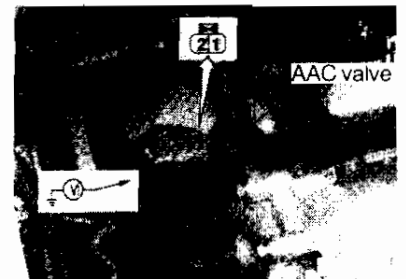

**(2) AAC valve system inspection**

- Use "AAC VALVE OPENING" item in "ACTIVE TEST" mode to set an optional angle. 
- Check that idle speed changes corresponding to setting value at this time.

◆ ACTIVE TEST ◆	
AAC/V OPENING MONITOR	27%
CAS.RPM (POS)	950rpm
AIR FLOW MTR	0.93V
AIR FLOW MER-R	0.92V
ENG TEMP SEN	68°C
Qu	UP DWN Qd

**(3) AAC valve power supply inspection**

- Disconnect AAC valve connector and measure voltage between the following terminals.

Engine	RB26DETT	RB20E / DE / DET
Measurement location	Between AAC valve connector harness terminal 1 and ground	Between AAC valve connector harness terminal 2 and ground
When ignition switch is ON	Battery voltage	Battery voltage

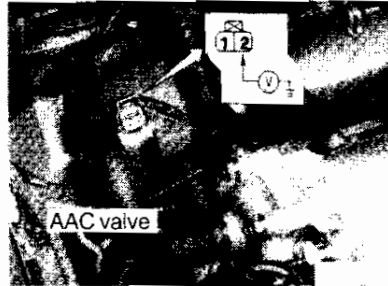

**RB26DETT**

OR:

- Measure voltage between the middle harness connector terminal 7 and the ground.

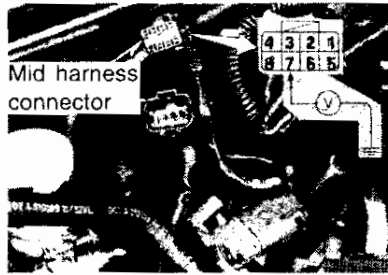

**(4) Harness continuity inspection**

- Disconnect the connector from ECCS control unit and AAC valve and measure the resistance between the following terminals.

**RB20E / DE / DET**

Engine	Measurement location	Resistance
RB20DE / DET	Between ECCS control unit harness terminal 4 and AAC valve harness terminal 1	0 Ω
RB20E	Between ECCS control unit harness terminal 113 and AAC valve harness terminal 1	

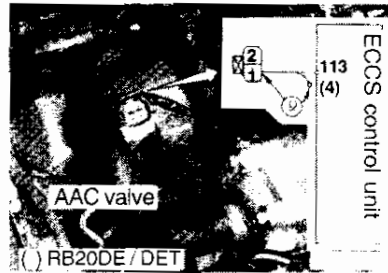

**RB26DETT**

Engine	Measurement location	Resistance
RB26DETT	Between ECCS control unit harness terminal 4 and AAC valve harness terminal 2	0 Ω
	Between middle connector AAC valve terminal 3 and AAC valve harness terminal 2	

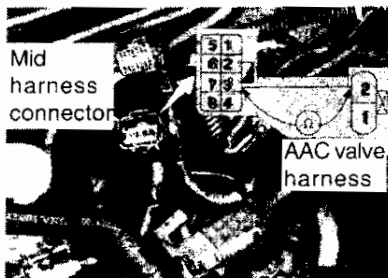
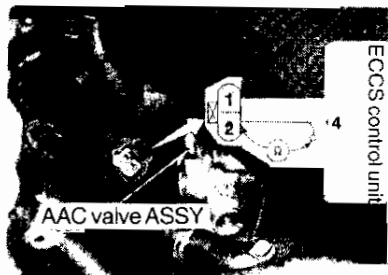

**(5) AAC valve inspection**

- Disconnect the AAC valve connector and measure the resistance between the following AAC valve terminals.

Measurement location	RB26DETT / RB20E / DE / DET
Between AAC valve terminal 1 and 2	9 ~ 10 Ω

**RB20E / DE / DET**

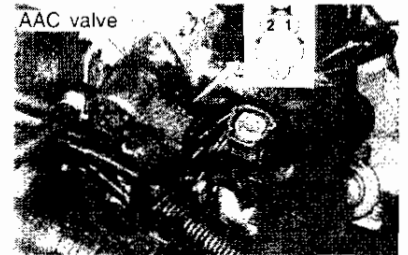

**RB26DETT**

**RB26DETT**

- Measurement can also be performed at middle connector terminals.

Measurement location	RB26DETT
Between AAC valve terminal 3 and 7	9 ~ 10 Ω

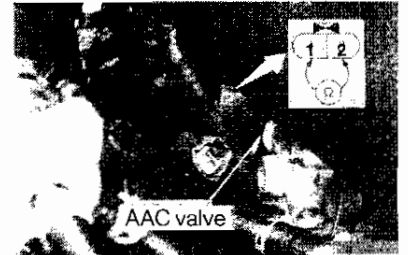

**RB26DETT ONLY**

**(6) Air regulator power supply inspection**

- Measure the voltage between the following terminals and ground when the air regulator middle harness is connected.

Condition	RB26DETT
Measurement location	Between middle harness connector terminal 8 and ground
Ignition switch ON	Battery voltage for 5 sec
Cranking	Approx. 10V
Idling	Battery voltage

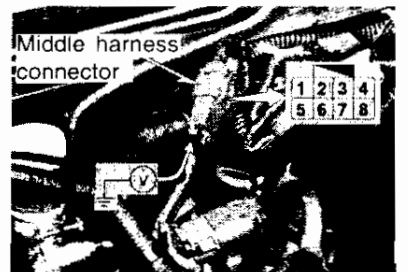

**(7) Air regulator inspection**

1. Shutter opening angle inspection (static characteristic)
  - Visually inspect the shutter angle

Ambient temperature °C	Shutter opening angle
Below -20°C	Fully open
20°C	Half open
Above 60°C	Fully closed

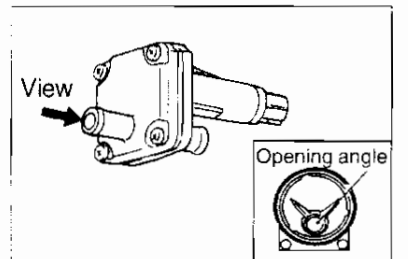

2. Inspection (dynamic characteristic)
  - Apply current from the battery to the terminals and check changes in shutter opening angle. The shutter must gradually close fully within 7 minutes.

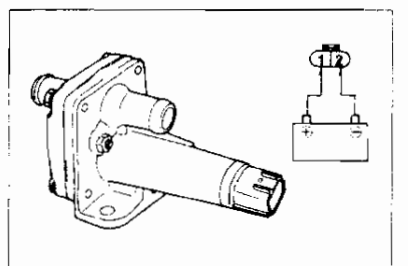

5-4 IDLE SPEED CONTROL SYSTEM INSPECTION  
CONTROL CIRCUIT DIAGRAM CA18i ENGINE

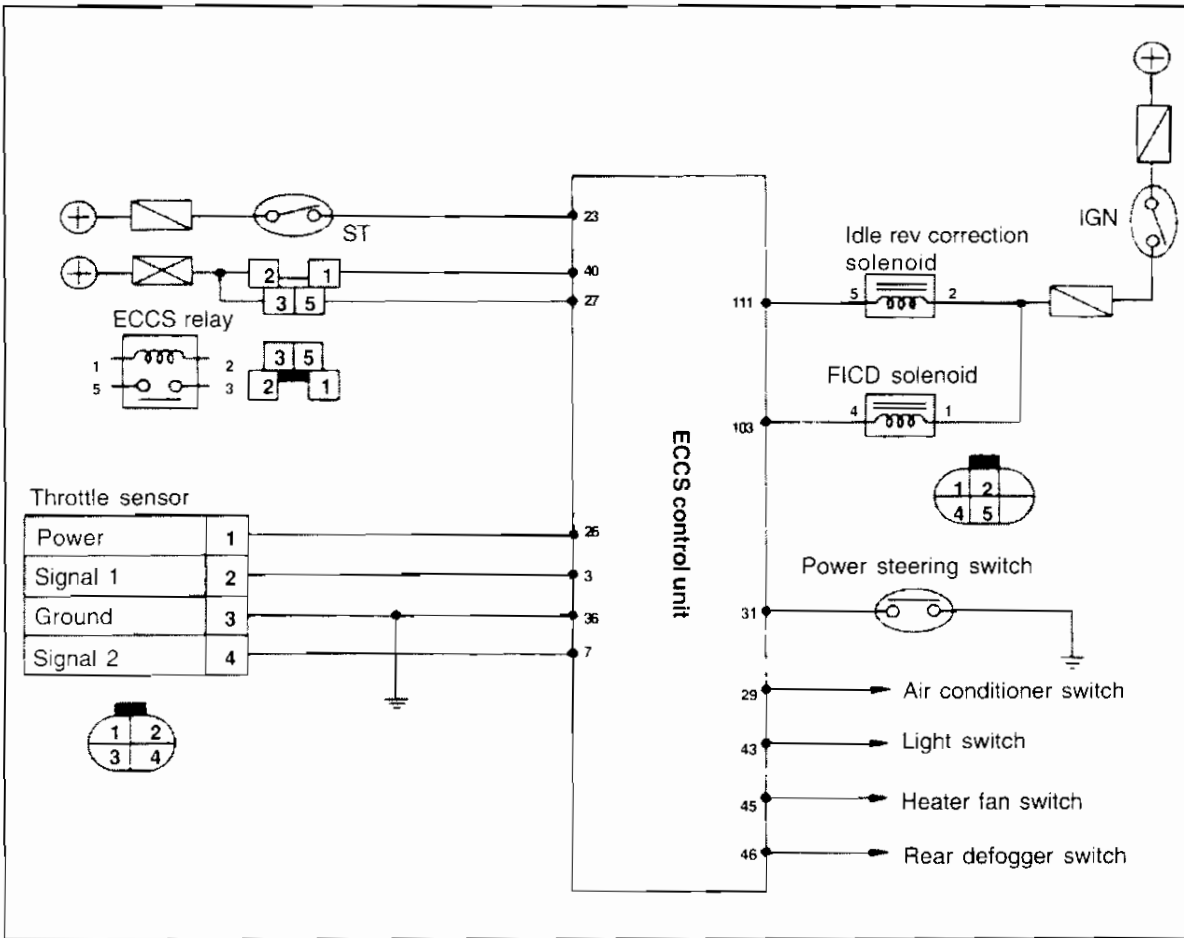

[Control description]

Input signal	Terminal No.	Control description
Air conditioner switch	29	After engine warms up, increases idle when air conditioning is turned ON.
Power steering switch	31	Power steering switch ON.
Light switch *	43	Turns on idle rev correction solenoid when switch is turned ON and increases idle. (* D range for A/T vehicle)
Heater fan switch *	45	
Rear defogger switch *	46	
FICD solenoid	103	Increases idle when air conditioning is turned ON.
Idle rev correction solenoid	111	Increases idle when power steering, head lamp, heater fan, rear defogger switches are ON.

Idle speed control system trouble diagnosis flowchart CA18i ENGINE

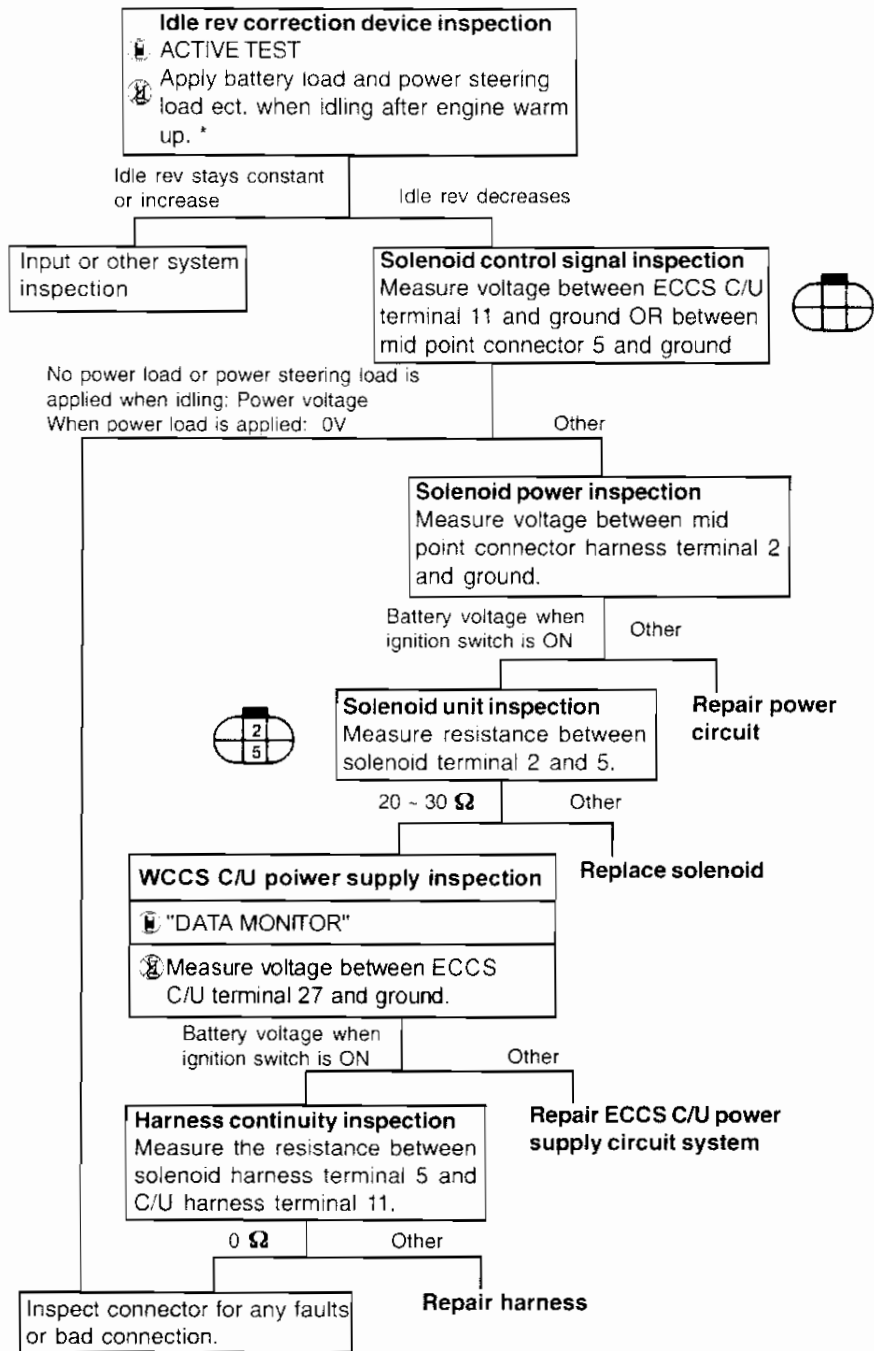

ECCS control unit terminal arrangement

101	102	103	104	105	106	107	108	37	38	39	40	41	42	1	2	3	4	5	6	7	8	9	10	21	22	23	24	25	26	27	28
109	110	111	112	113	114	115	116	43	44	45	46	47	48	11	12	13	14	15	16	17	18	19	20	29	30	31	32	33	34	35	36

**(1) Idle rev correction solenoid control signal inspection**

- Use "IDLE CORRECTION S/V" in "ACTIVE TEST" mode to set the value.
- Check that engine speed changes corresponding to setting value.
- Measure voltage between the following terminals when ECCS control unit connector is connected.

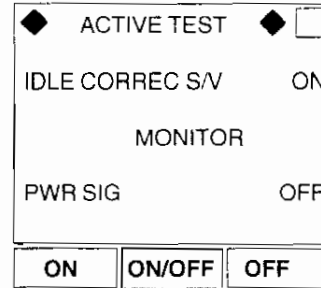

Condition		Between ECCS C/U terminal 111 and ground
When ignition switch is ON		0V
Engine running	Within 20 sec after engine is started	0V
	After 20 sec after engine is started	Battery voltage
When one of following switch is ON: P/S sw, light sw, rear defogger sw, blower fan sw		0V

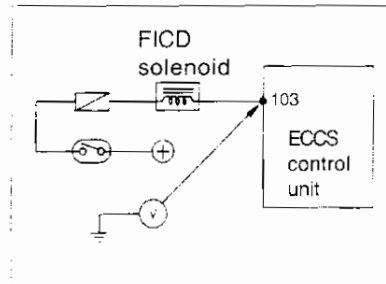

**(2) Idle rev correction solenoid power supply inspection**

- Disconnect idle rev correction solenoid connector and measure voltage between the following terminals.

Condition	Between FICD solenoid harness side terminal 1 and ground
Ignition switch is ON	Battery voltage

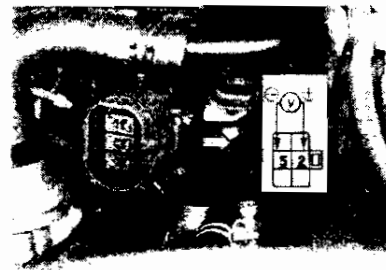

**(3) Harness continuity inspection**

- Disconnect idle rev correction solenoid connector and measure the resistance between the following terminals.

Between ECCS C/U harness side terminal 111 and idle rev correction solenoid harness side terminal 5	0 Ω
---	-----

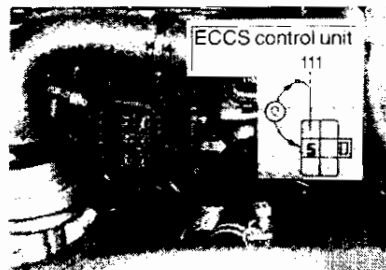

**(4) Idle rev correction solenoid unit inspection**

- Disconnect ECCS control unit and idle rev correction solenoid connectors and measure the resistance between the following terminals.

Between harness connector terminal 2 and 5	20 ~ 30 Ω
--	-----------

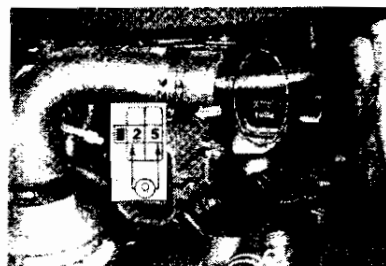

**(5) FICD solenoid control signal inspection**

- Use "FICD S/V" in "ACTIVE TEST" mode to set the value.
- Check that engine speed changes corresponding to set value.
- Measure voltage between the following terminals when ECCS control unit connector is connected.

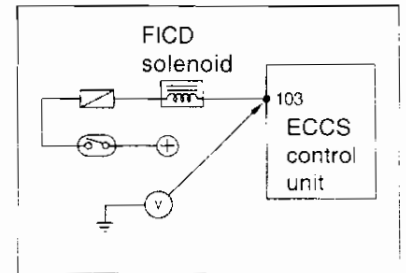

Condition	Measurement location	Between ECCS C/U terminal 103 and ground
When ignition switch is ON	A/C switch ON	0V
	A/C switch OFF	Battery voltage

**(6) FICD solenoid power supply inspection**

- Disconnect the connector and measure voltage between the following terminals.

Condition	Between FICD solenoid harness side terminal 1 and ground
Ignition switch is ON	Battery voltage

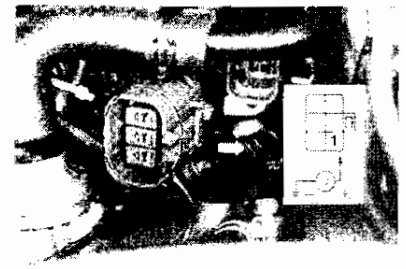

**(7) Harness continuity inspection**

- Disconnect FICD solenoid and measure the resistance between the following terminals.

Between ECCS C/U harness side terminal 103 and FICD solenoid harness side terminal 4	0
--	---

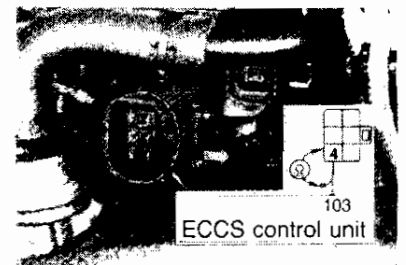

**(8) FICD solenoid inspection**

- Disconnect ECCS control unit and FICD solenoid connector and measure the resistance between following terminals.

Between harness connector terminal 1 and 4	20 ~ 30
--	---------

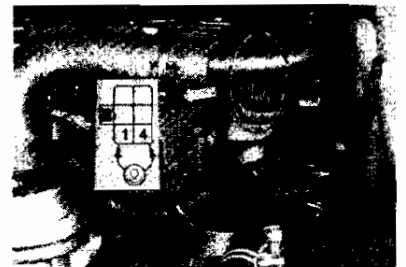

**5-5 WASTEGATE VALVE CONTROL SYSTEM INSPECTION  
CONTROL CIRCUIT DIAGRAM RB26DETT ENGINE**

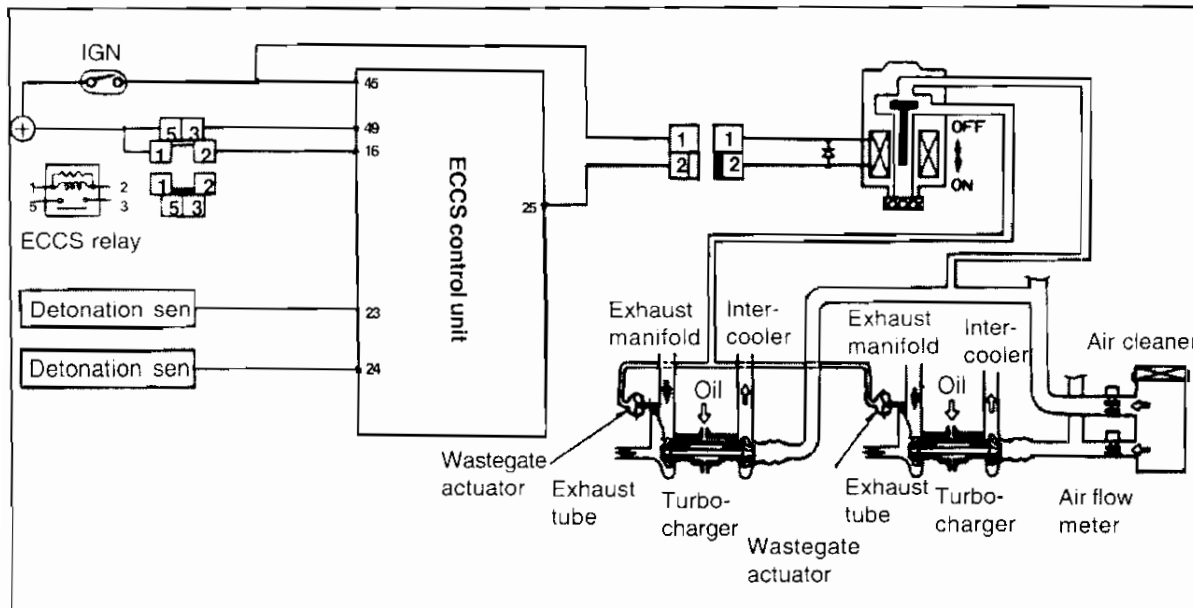

**Wastegate valve control system diagnosis flowchart RB26DETT ENGINE**

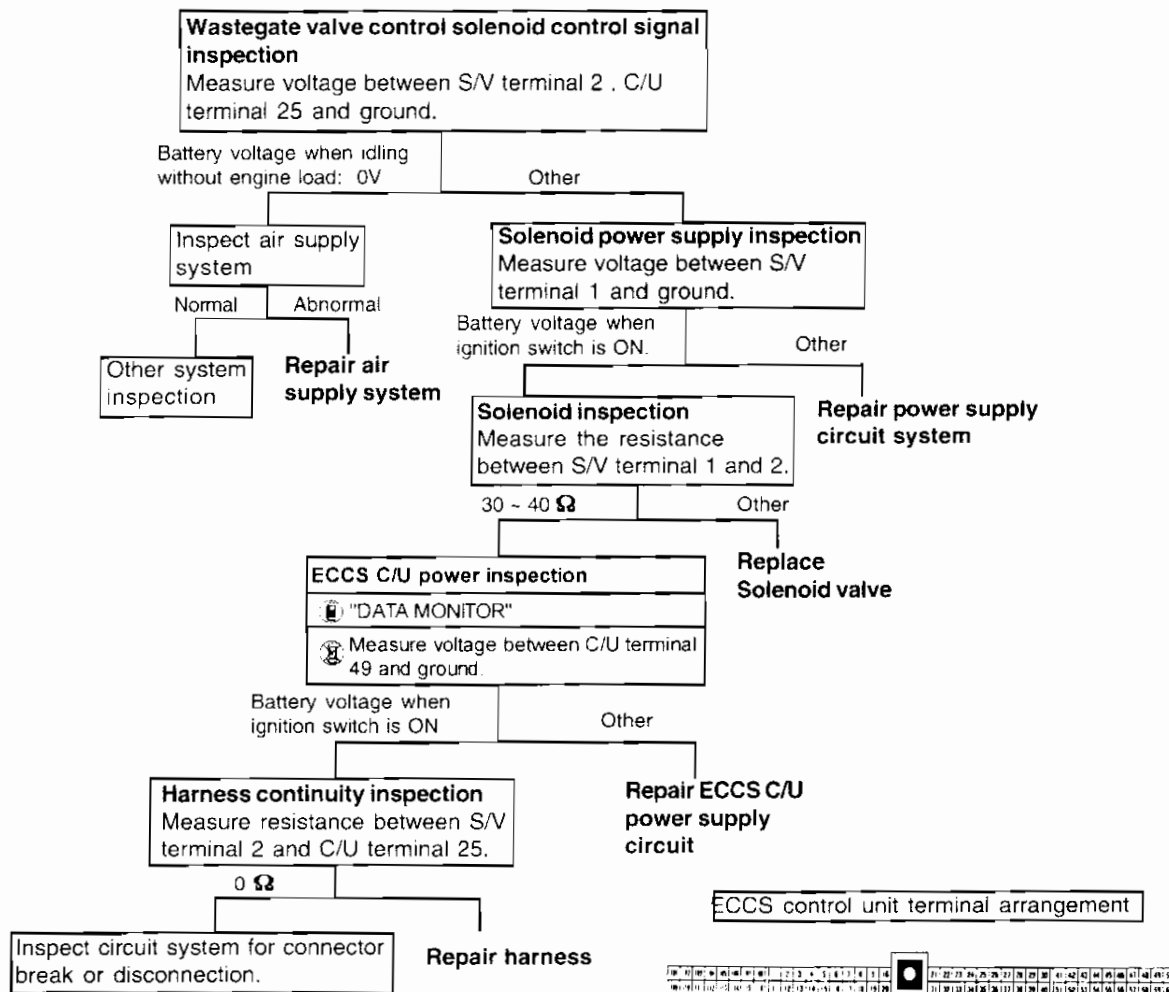



RB26DETT ENGINE

**(1) Wastegate valve control solenoid control signal inspection**

- When wastegate valve control solenoid connectors are connected, measure voltage between the following terminals.

OR

- When ECCS control unit connectors are connected, measure the voltage between the following terminals.



Engine	RB26DETT	
Measurement location	Between solenoid terminal 2 and ground	Between ECCS C/U terminal 25 and ground
Idling	Battery voltage	
With accelerator pedal depressed	Approx. 0	

**(2) Wastegate valve control solenoid power supply inspection**

- Disconnect wastegate valve control solenoid connector and measure the voltage between following terminals.

Between solenoid harness terminal 1 and ground	0 Ω
--	-----

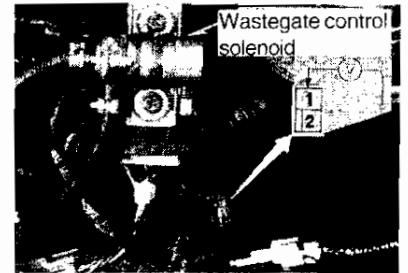

**(3) Wastegate valve control solenoid inspection**

- Disconnect wastegate valve control solenoid connector and measure the resistance between the following terminals.

Between solenoid terminals 1 and 2	30 ~ 40 Ω
------------------------------------	-----------

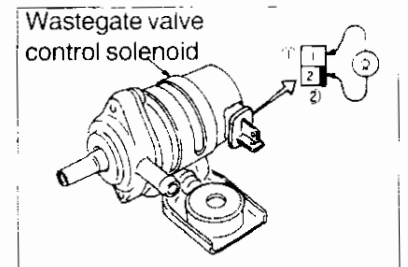

**(4) ECCS control unit power supply inspection**

- Refer to the fuel pump system section.

**(5) Harness continuity inspection**

- Disconnect the connectors from the wastegate valve control solenoid and ECCS control unit and measure the resistance between the following terminals.

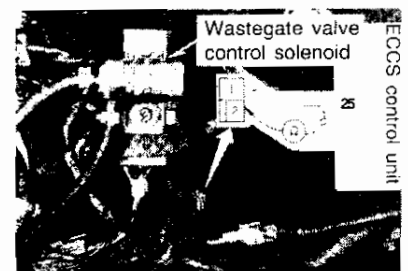

**5-6 PTC HEATER CONTROL SYSTEM INSPECTION  
CONTROL CIRCUIT DIAGRAM CA18i ENGINE**

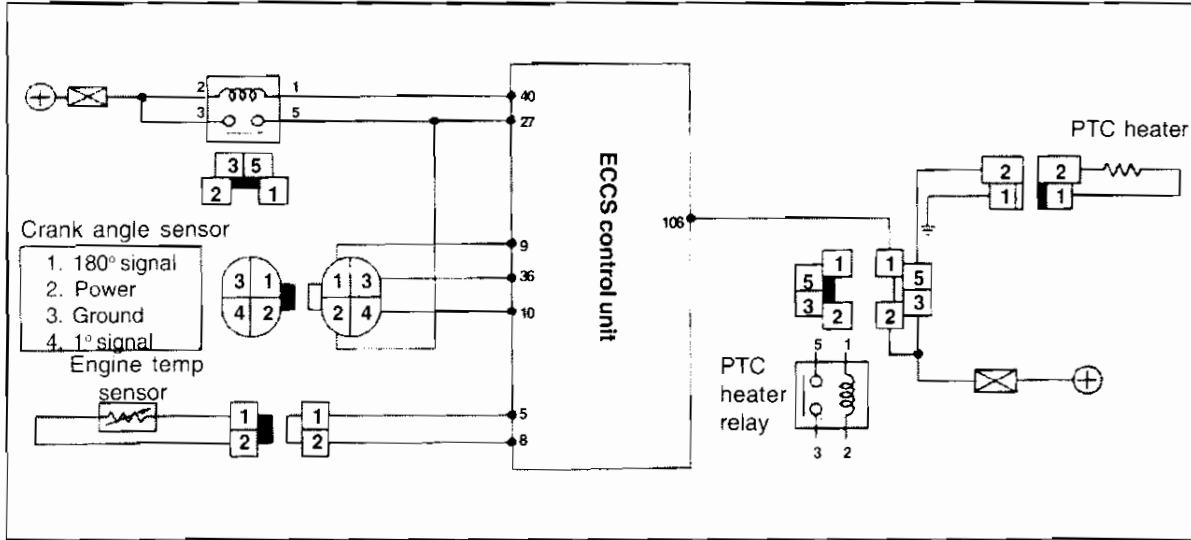

**(1) PTC heater control signal inspection**

- When ECCS control unit connectors are connected, measure the voltage between the following terminals.

Condition	Between ECCS C/U terminal 106 and ground
Engine temp (below 65°C) when engine is running (Battery voltage over 13V)	Approx. 0V

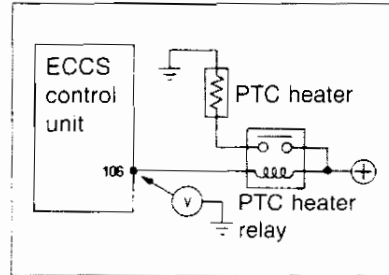

**(2) PTC heater power supply inspection**

- Disconnect PTC heater connector and measure the voltage between following terminals.

Condition	Between PTC heater harness terminal 2 and ground
Low engine temperature when engine is running (Battery voltage over 13V)	Battery voltage



**(3) ECCS control unit power**

- When ECCS control unit connectors are connected, measure voltage between the following terminals.

Condition	Between ECCS C/U terminal 27 and ground	Between ECCS C/U terminal 40 and ground
When ignition switch is OFF	0V	Battery voltage
When ignition switch is ON	Battery voltage	0V

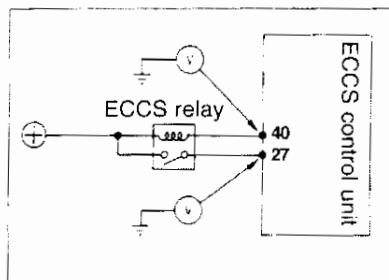

**Note:**

Same condition as ON will be retained for 15 seconds after the ignition switch has been turned from ON to OFF.

**(4) Harness continuity inspection**

- Disconnect ECCS control unit, PTC heater connector and PTC heater relay and measure the resistance between following terminals.

Between ECCS C/U terminal 106 and PTC heater relay harness terminal 1	<b>0 Ω</b>
Between PTC relay harness terminal 5 and PTC heater harness terminal 2	
Between PTC heater harness terminal 1 and ground	

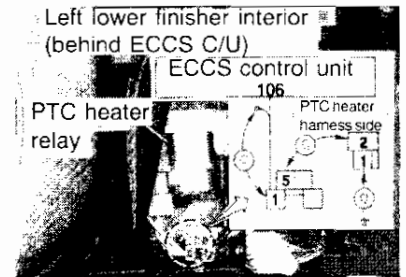

**(5) PTC heater inspection**

- Disconnect PTC heater connector and measure resistance between the following terminals.

Between PTC heater terminals 1 and 2	Approx. 1 Ω
--------------------------------------	-------------

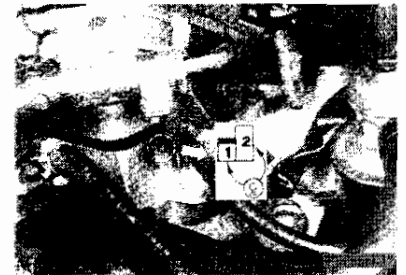

**5-7 LOCK UP RELEASE CONTROL SYSTEM INSPECTION (A/T VEHICLE)  
CONTROL CIRCUIT DIAGRAM CA18i ENGINE**

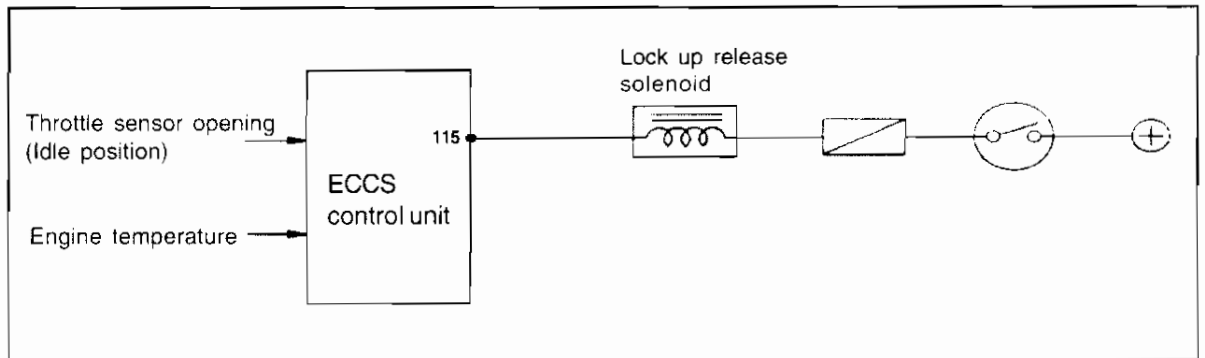

**(1) Lock up release solenoid control signal inspection**

- When ECCS control unit connectors are connected, measure the resistance between following terminals.

Condition		Between ECCS C/U terminal 115 and ground
<b>Ignition switch ON</b>	Engine temperature below 65°C or throttle sensor in idle position	Approx. 0V
	Other (apply load)	Power voltage

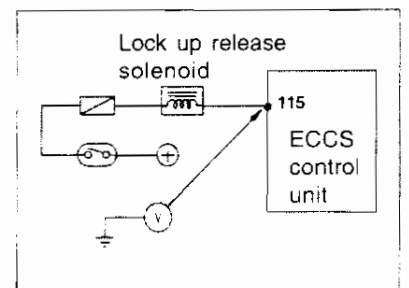

## 6. SENSOR SYSTEM INSPECTION

Use measurement tools such as circuit tester . CONSULT electrical system diagnosis tester and oscilloscope to test the sensor system. Refer to section EN 3, 1, 1 - 1, (6) in TROUBLE DIAGNOSIS section for an explanation of the measurement equipment operation procedures. Refer to section 5 for the preparation.

### 6-1 CRANK ANGLE SENSOR CONTROL CIRCUIT DIAGRAM RB26DETT ENGINE

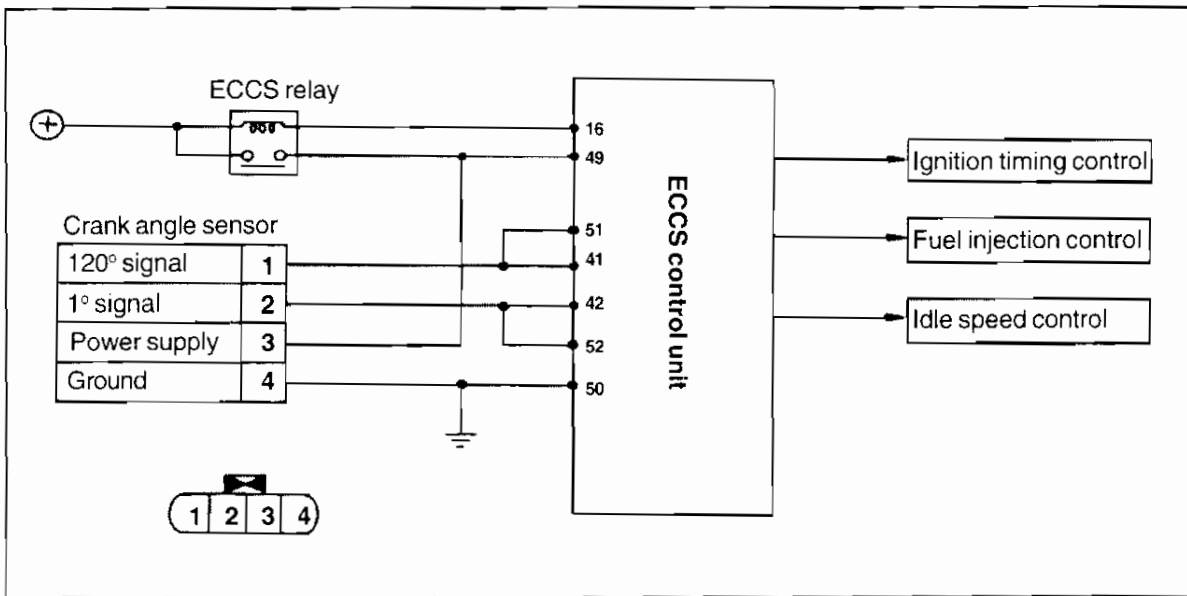

**Crank angle sensor system trouble diagnosis flowchart RB26DETT ENGINE**

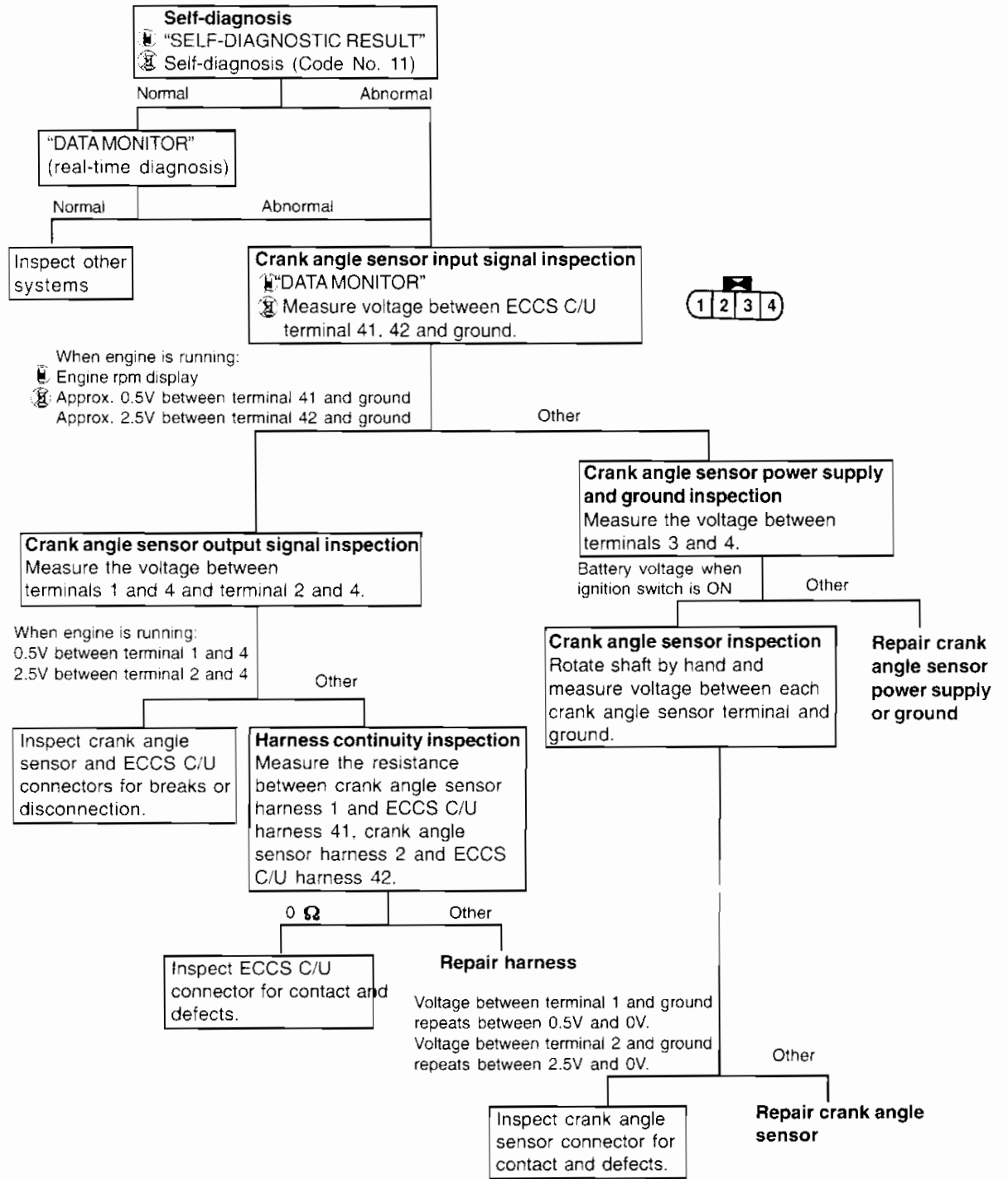

**Note:**

For crank angle sensor system inspection, use CONSULT and oscilloscope to check output waveform.

ECCS control unit terminal arrangement

10	12	102	14	125	106	107	1	2	3	4	5	6	7	8	9	10	21	22	23	24	25	26	27	28	29	30	41	42	43	44	45	46	47	48	49	50
108	119	111	112	114	115	16	11	12	13	14	15	16	17	18	19	20	31	32	33	34	35	36	37	38	39	40	51	52	53	54	55	56	57	58	59	60

**6-1 CRANK ANGLE SENSOR  
CONTROL CIRCUIT DIAGRAM RB20E / DE / DET ENGINE**

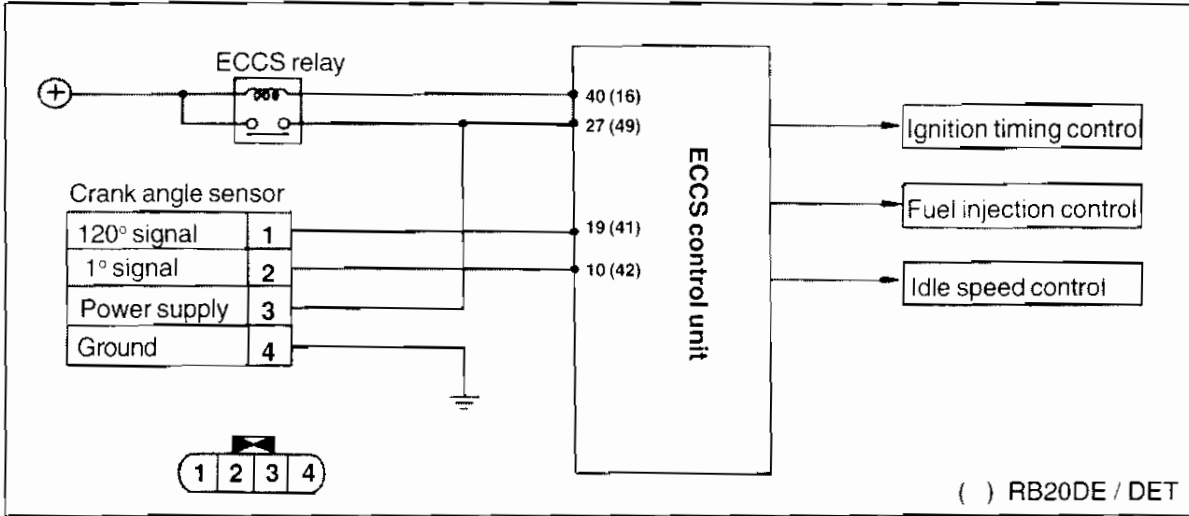

**Crank angle sensor system trouble diagnosis flowchart  
RB20E / DE / DET ENGINE**

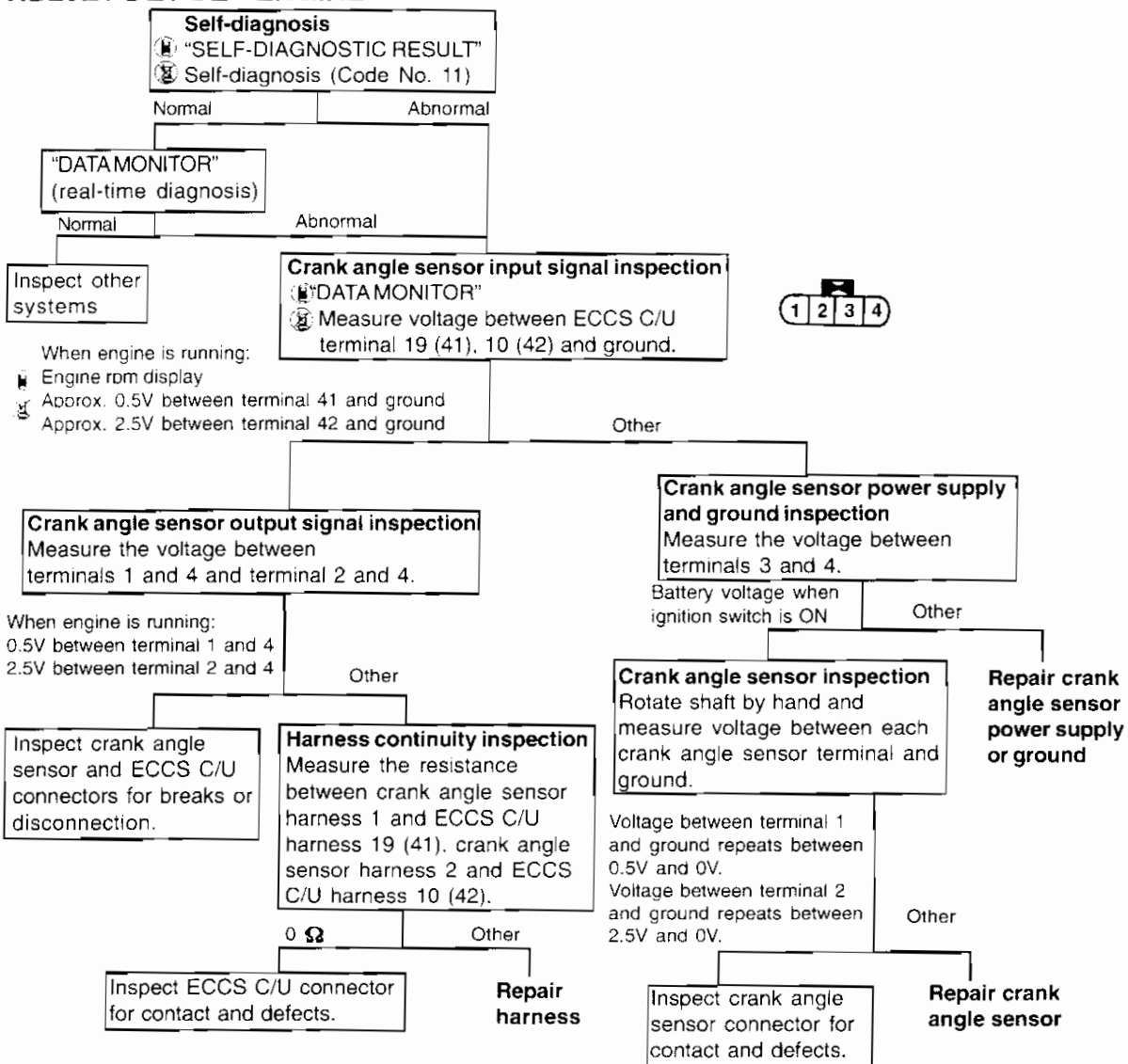

**6-1 CRANK ANGLE SENSOR CONTROL CIRCUIT DIAGRAM CA18i ENGINE**

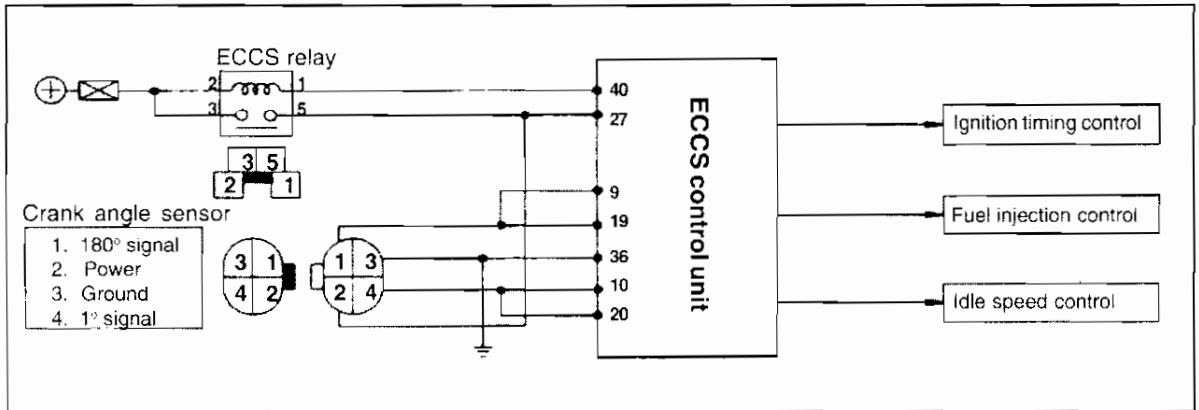

**Crank angle sensor system trouble diagnosis flowchart CA18i Engine**

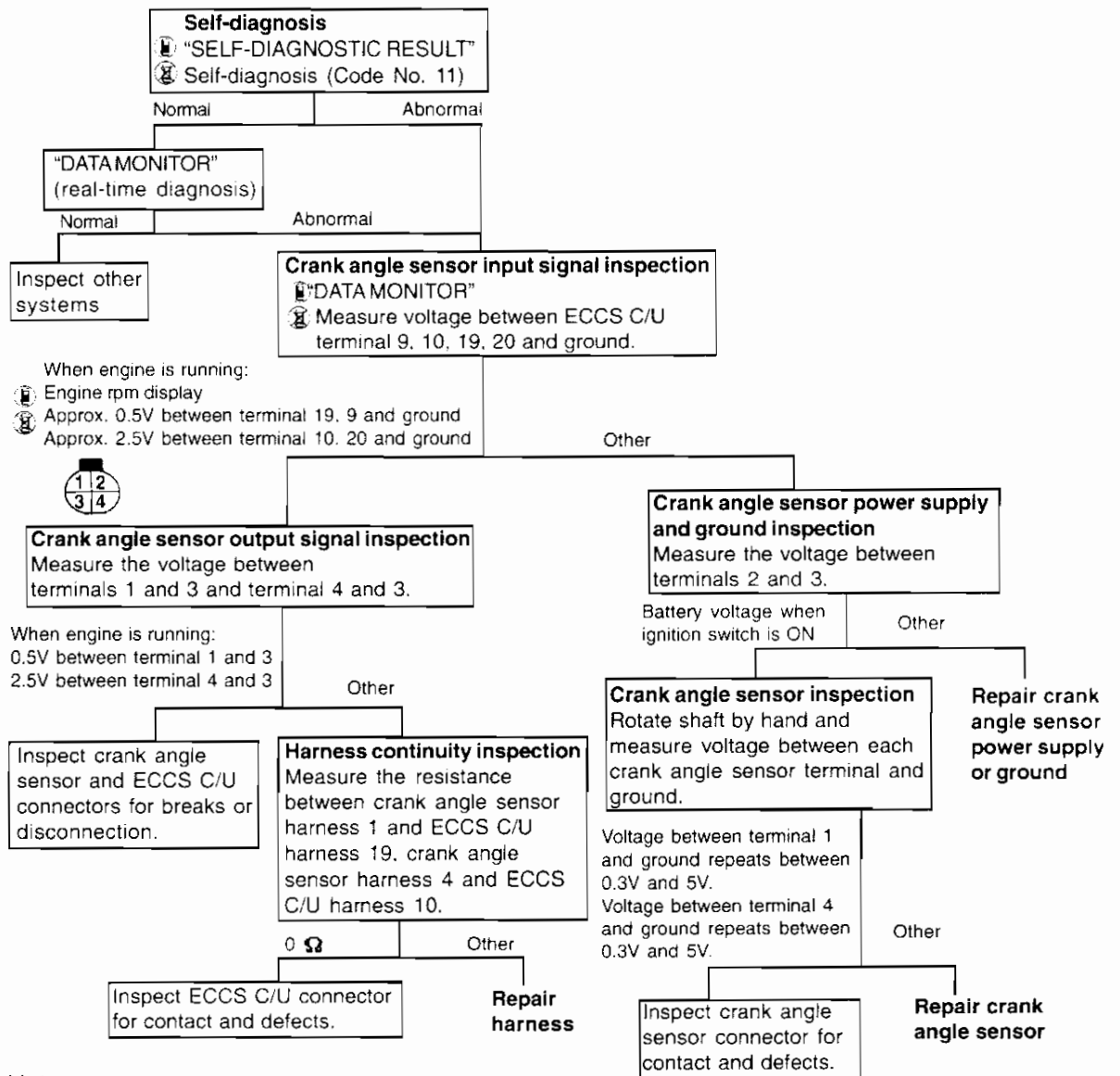

**Note:**

For crank angle sensor system inspection, use CONSULT and oscilloscope to check output waveform.

**(1) Self-diagnosis**

- If 1° or 180° (1° or 120° for RB20E / DE / DET) signal is not input within fixed period of time, "CODE No. 11" or "FAULTY SYSTEM NAME" will be displayed in normal self-diagnosis operation when using CONSULT. Examine the following items carefully when this occurs.



- When malfunction occurs again, use the real-time diagnosis (CONSULT "DATA MONITOR" mode) or oscilloscope to detect disconnection.

- When an abnormality is detected, consider these locations in the following sequence as there may be other malfunctions besides the crank angle sensor.

**ECCS harness (faulty contact) - Crank angle sensor - ECCS control unit**

**(2) Input signal inspection**

- Use "CAS.RPM (POS)" item in "DATA MONITOR" to determine engine speed.



★ MONITOR	★ NO FAIL	📄
CAS.RPM (POS)	975rpm	
AIR FLOW MTR	0.91V	
AIR FLOW MTR (R)	0.92V	
ENG TEMP SEN	78°C	
EXH GAS SEN	1.22V	
EXH GAS SEN (R)	0.02V	
M/R R/C MNT	RICH	
M/R F/C MNT-R	RICH	
CAR SPEED SEN	0km/h	
RECORD		

- Measure the voltage between following terminals with ECCS control unit harness connected.



**RB26DETT / RB20E / DE / DET**

Engine	RB26DETT / RB20E / DE / DET / RB20E	
<b>Measurement location</b>	ECCS C/U terminal 41(49) and ground (120° signal)	ECCS C/U terminal 42 (10) and ground (1° signal)
<b>Ignition switch in ON position</b>	0V or approx. 5V	0V or approx. 5V
<b>Cranking</b>	Approx. 0.5V	2 ~ 3V
<b>Idling</b>	0.3 ~ 0.7V	2 ~ 3V

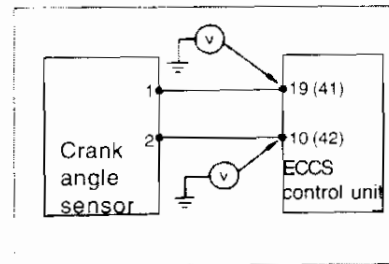

**CA18i**

Engine	CA18i	
<b>Measurement location</b>	ECCS C/U terminal 19 and ground (180° signal)	ECCS C/U terminal 10 and ground (1° signal)
<b>Ignition switch in ON position</b>	Approx. 0.3V or 5V	Approx. 0.3V or 5V
<b>Cranking</b>	-	-
<b>Idling</b>	Approx. 2 ~ 3V	Approx. 2 ~ 3V

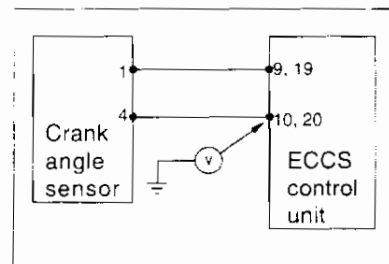

**Note:**

The voltage in above charts are average voltage values of the pulse waveform measured by a circuit tester and these are for reference only. The waveform must be checked by using an oscilloscope.

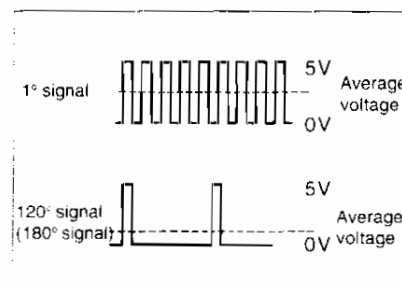



**(3) Sensor output signal inspection**

- Measure the voltage between following terminals with crank angle sensor connector connected.

Engine	RB26DETT / RB20E / DE / DET		
<b>Measurement location</b>	Crank angle sensor terminal 2 and ground (1° signal)	Crank angle sensor terminal 1 and ground (120° signal)	Crank angle sensor terminal 3 and ground (Power)
<b>Ignition switch in ON position</b>	0V or approx. 5V	0V or approx. 5V	Battery voltage
<b>Cranking</b>	2 ~ 3V	Approx. 0.5V	Battery voltage
<b>Idling</b>	2 ~ 3V	0.3 ~ 0.7V	Battery voltage
Engine	CA18i		
<b>Measurement location</b>	Crank angle sensor terminal 4 and ground (1° signal)	Crank angle sensor terminal 1 and ground (180° signal)	Crank angle sensor terminal 2 and ground (Power)
<b>Ignition switch in ON position</b>	Approx. 0.3V or 5V	Approx. 0.3V or 5V	Battery voltage
<b>Cranking</b>	-	-	-
<b>Idling</b>	Approx. 2 ~ 3V	Approx. 2 ~ 3V	Battery voltage

**RB26DETT / RB20DE / DET**

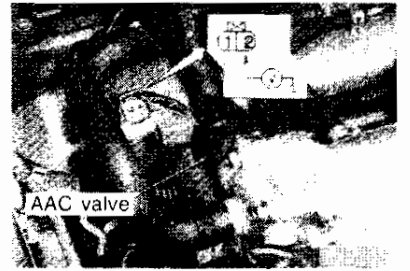

**RB20E**



**CA18i**

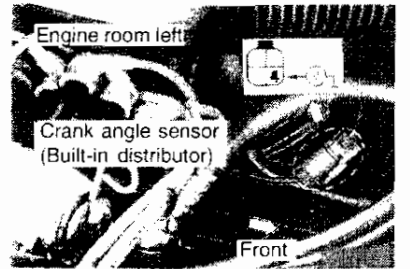

**RB26DETT / RB20DE / DET**



**RB20E**

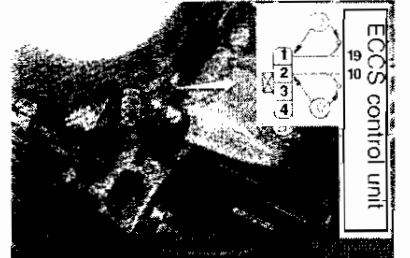

**CA18i**

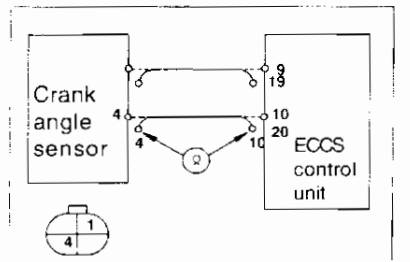

**(4) Harness continuity inspection**

- Disconnect ECCS control unit and crank angle sensor connector and measure the resistance between following terminals.

Engine	Between ECCS C/U Harness	Crank angle sensor	Ω
<b>RB26DETT / RB20DE / DET</b>	41	1	0
	42	2	
<b>RB20E</b>	19	1	
	10	2	
<b>CA18i</b>	9 (or 19)	1	
	10 (or 20)	4	

## SENSOR SYSTEM INSPECTION

RB26DETT / RB20E / DE / DET / CA18i ENGINE

### (5) Crank angle sensor inspection

- Disconnect crank angle sensor from engine, turn the shaft by hand and measure the voltage using connector.

RB26DETT / RB20E / DE / DET	
Crank angle sensor 2 and ground (1° signal)	0V or approx. 5V
Crank angle sensor 1 and ground (120° signal)	0V or approx. 5V
Crank angle sensor 3 and ground (Battery voltage)	Power voltage
Crank angle sensor 4 and ground (ground)	0V

CA18i	
Crank angle sensor 4 and ground (1° signal)	0.3V or approx. 5V
Crank angle sensor 1 and ground (180° signal)	0.3V or approx. 5V

#### Caution:

To prevent injector from operating, remove fuse or connector before inspection. When an apparent abnormality is detected by self-diagnosis according to shaft rotation, be careful as it may not be an actual abnormality in this case.

#### RB26DETT / RB20DE / DET

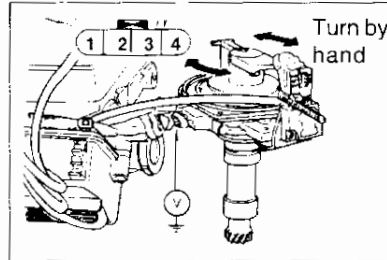

#### RB20E

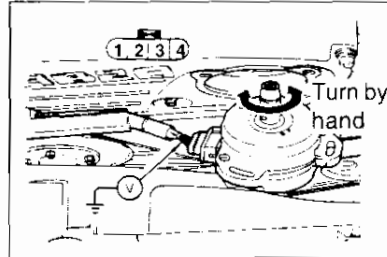

#### CA18i

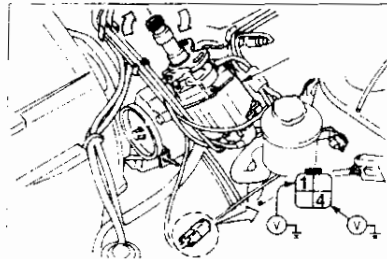

**6-2 AIR FLOW METER SENSOR SYSTEM INSPECTION  
CONTROL CIRCUIT DIAGRAM RB26DETT ENGINE**

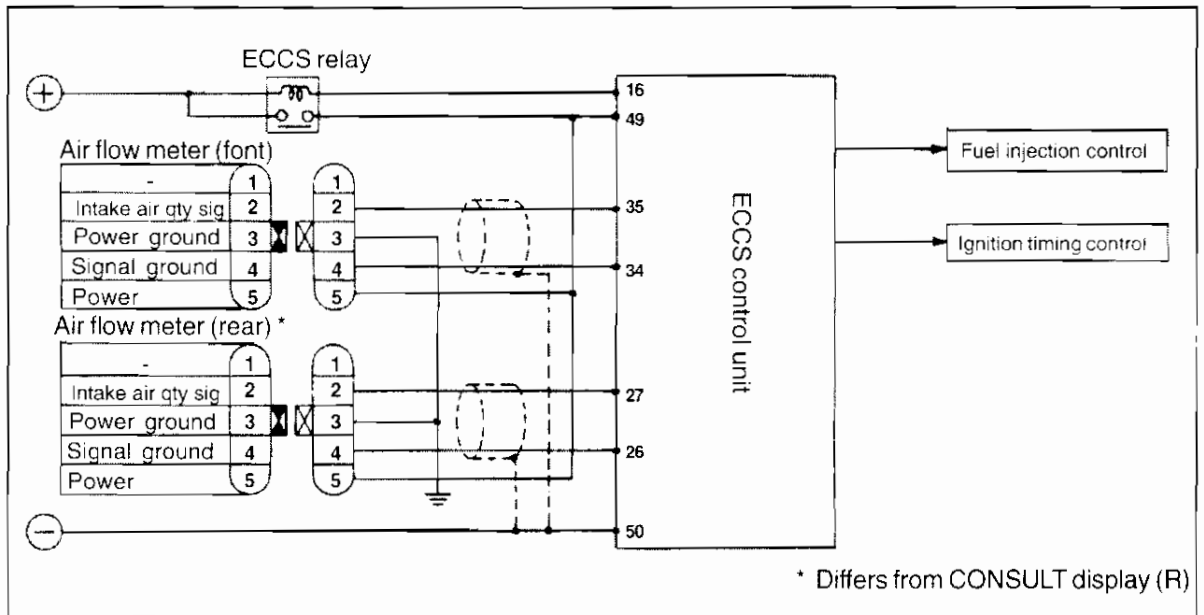

**Cylinder, air flow meter and CONSULT (data monitor) display items**

Cylinder No.	Air flow meter	ECCS C/U terminal No.	CONSULT (data monitor) display
No. 4, 5, 6 cyl	AFM (front)	ECCS C/U 35	Air flow meter (R)
No. 1, 2, 3 cyl	AFM (rear)	ECCS C/U 27	Air flow meter

**Air flow meter sensor system trouble diagnosis flowchart RB26DETT ENGINE**

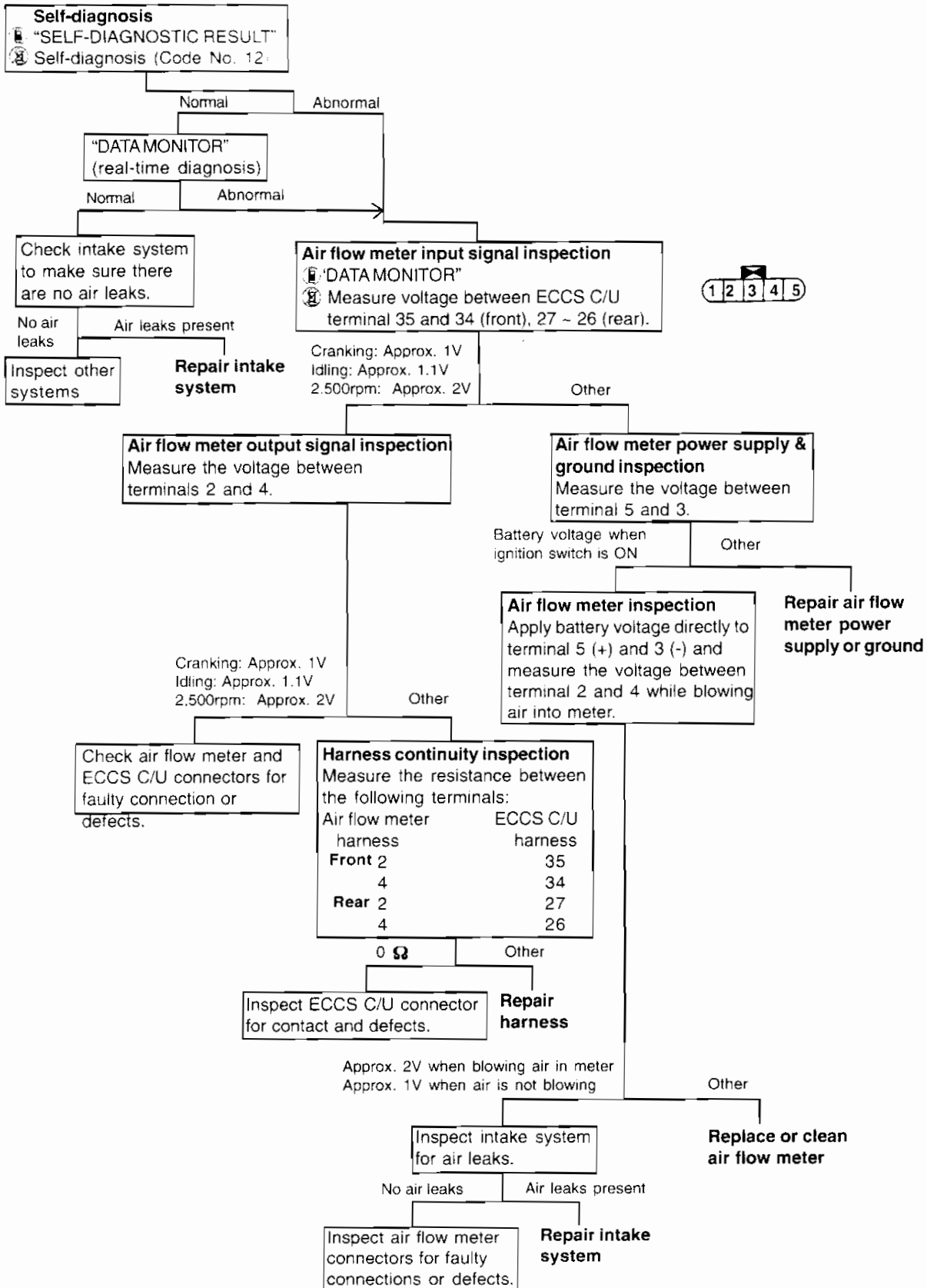

**6-2 AIR FLOW METER SENSOR SYSTEM INSPECTION  
CONTROL CIRCUIT DIAGRAM RB20E / DE / DET ENGINE**

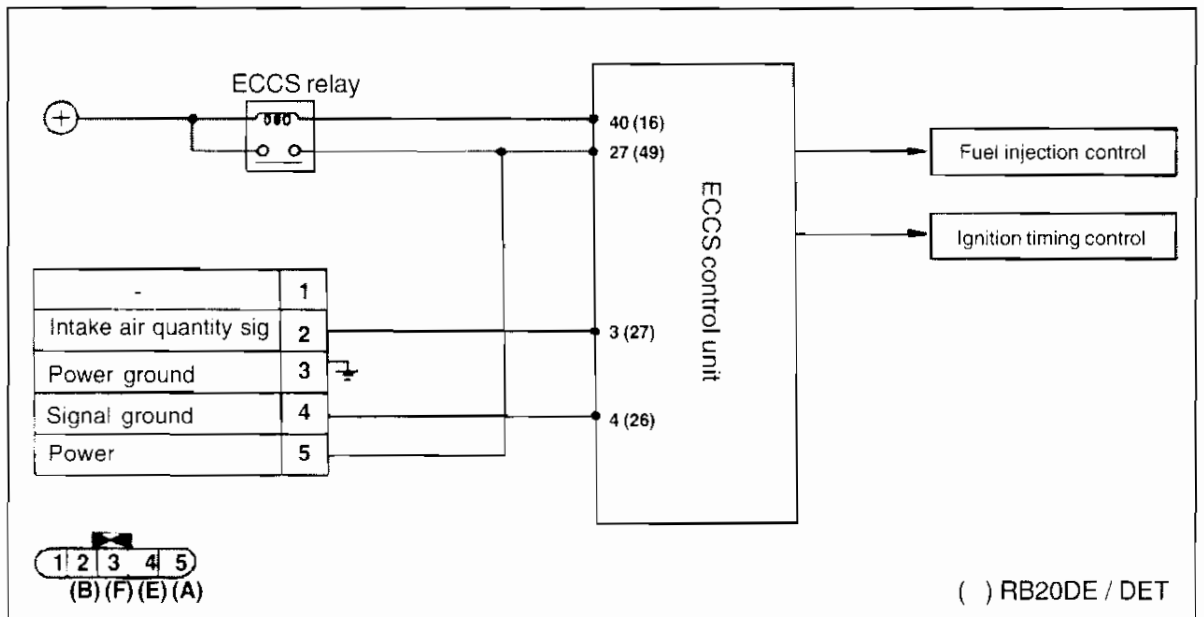

**Air flow meter sensor system trouble diagnosis flowchart  
RB20E / DE / DET ENGINE**

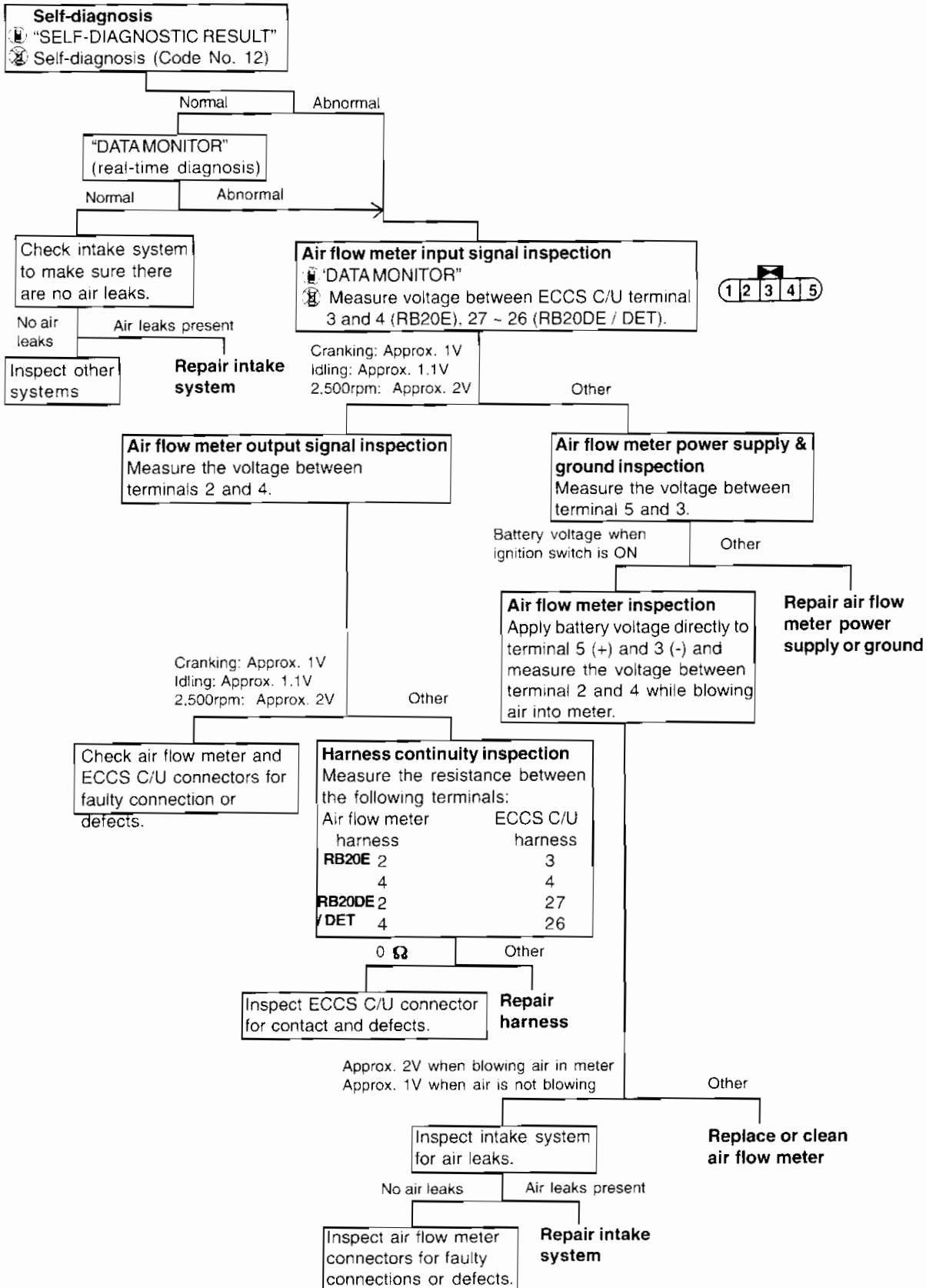

**(1) Self-diagnosis**

- Normally in a self-diagnosis operation, "CODE No.12" or "FAULTY SYSTEM - AIR FLOW METER" (when using CONSULT) is displayed if the intake air quantity signal voltage is abnormally high or low and disconnection or short-circuit in the signal system should be considered.



- When malfunction occurs again, use real-time diagnosis (CONSULT "DATA MONITOR" mode) or oscilloscope to detect instantaneous breaks.

- When abnormality is detected, consider these locations in the following sequence as there may be other malfunctions besides the air flow sensor.

**When intake air quantity is low:** ECCS harness (faulty contact) - air flow meter - ECCS control unit - intake system (not airtight)

**When intake air quantity is high:** ECCS harness (faulty contact) - intake system (not airtight), faulty wastegate valve control - air flow meter - ECCS control unit

**(2) Input signal inspection**

- Use "AIR FLOW METER" and "AIR FLOW METER (R)" in "DATA MONITOR" mode to check the following items.



Engine	RB26DETT	RB20E / DE / DET
<b>Ignition switch is ON</b>	Approx. 0.3V	Approx. 0.5V
<b>Idling</b>	Approx. 1.1V	Approx. 1.1V
<b>2500rpm</b>	Approx. 1.5 ~ 2.0V	Approx. 1.5 ~ 2V

☆ MONITOR ☆ NO FAIL

CAS.RPM (POS) 950rpm  
 AIR FLOW MTR 0.96V  
 AIR FLOW MTR (R) 0.87V

---

RECORD

- Measure the voltage between following terminals with ECCS control unit harness connected.



Engine	RB26DETT	
Item	Air flow meter F (R)	
<b>Measurement location</b>	ECCS C/U terminal 35 (27) and ground (intake air quantity signal)	ECCS C/U terminal 34 (26) and ground (ground signal)
<b>Ignition switch is ON</b>	Approx. 0.3V	0V
<b>Cranking</b>	Approx. 1V	0V
<b>Idling</b>	Approx. 1.1V	0V

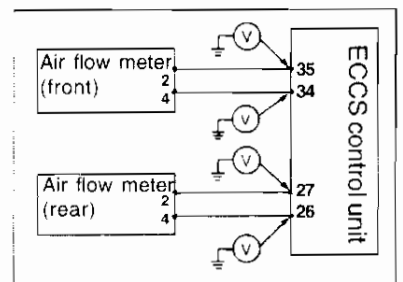

Engine	RB20E (DE, DET)	
<b>Measurement location</b>	ECCS C/U terminal 3 (27) and ground (intake air quantity signal)	ECCS C/U terminal 4 (26) and ground (ground signal)
<b>Ignition switch is ON</b>	Approx. 0.3V	0V
<b>Cranking</b>	Approx. 1V	0V
<b>Idling</b>	Approx. 1.1V	0V

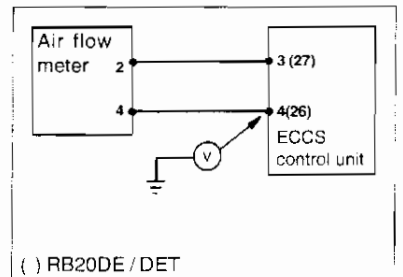

**(3) Air flow meter output signal inspection**

- Measure the voltage between following terminals when the air flow meter connectors connected.

Engine	RB26DETT	
<b>Measurement location</b>	Air flow meter terminal 2 and ground (intake air quantity signal)	Air flow meter terminal 4 and ground (ground signal)
<b>Ignition switch is ON</b>	Approx. 0.3V	0V
<b>Cranking</b>	Approx. 1V	0V
<b>Idling</b>	Approx. 1.1V	0V

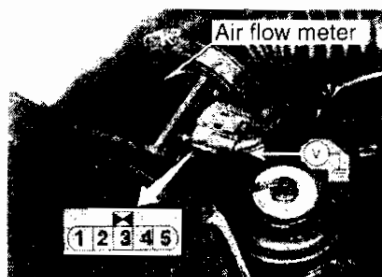

Engine	RB20E / DE / DET	
<b>Measurement location</b>	Air flow meter terminal B and ground (intake air quantity signal)	Air flow meter terminal E and ground (ground signal)
<b>Ignition switch is ON</b>	Approx. 0.8V	0V
<b>Cranking</b>	Approx. 1V	0V
<b>Idling</b>	Approx. 1.1V	0V

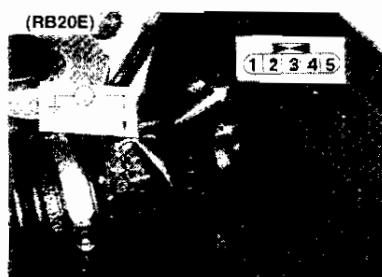

**(4) Air flow meter power supply inspection**

- Measure the battery voltage between following terminals with the air flow meter connector connected.

Ignition switch ON and engine running	Between air flow meter terminal 5 and ground	Battery voltage
---------------------------------------	--	-----------------

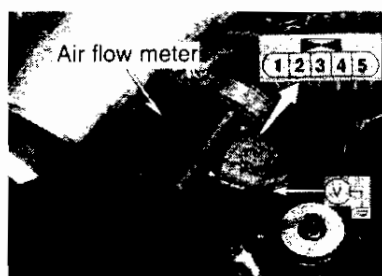

**(5) Harness continuity inspection**

- Disconnect ECCS control unit and air flow meter connector and measure the resistance between following terminals.

Engine	RB26DETT	RB20E (DE / DET)
	<b>Air flow meter front (rear)</b>	<b>Air flow meter harness</b>
<b>Measurement location</b>	Terminal 2 & terminal 35(27)	Terminal 2 & terminal 3 (27)
	Terminal 4 & terminal 34 (26)	Terminal 4 & terminal 4 (26)
	Terminal 3 & Body ground	Terminal 3 & Body ground
	Terminal 5 & ECCS reay harness terminal 3	Terminal 5 & ECCS reay harness terminal 3
<b>Ω</b>	0	0

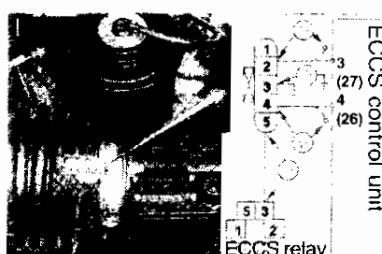
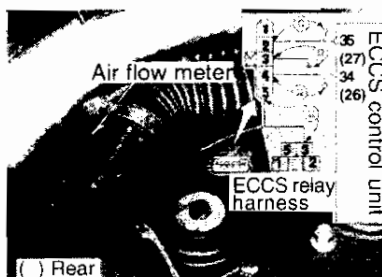

**(6) Air flow meter inspection**

- Apply the battery voltage directly to terminal 5 (+) and 3 (-) and measure the voltage change between terminals 2 (+) and 4 (-) while blowing air on hot wire.

No air blown	Approx. 0.8V
Air blown	Approx. 2V

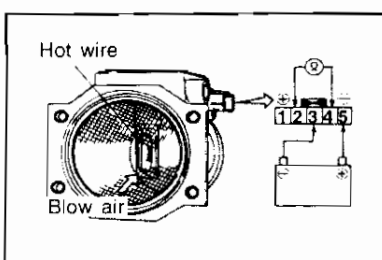



**6-3 THROTTLE VALVE SWITCH SYSTEM INSPECTION  
CONTROL CIRCUIT DIAGRAM RB26DETT ENGINE**

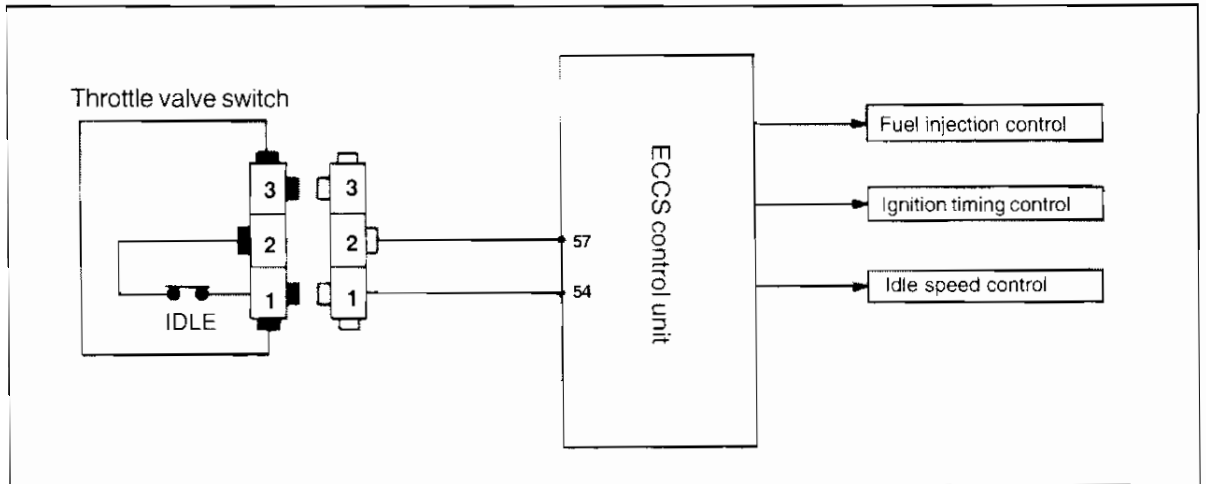

**Throttle valve switch system trouble diagnosis flowchart RB26DETT ENGINE**

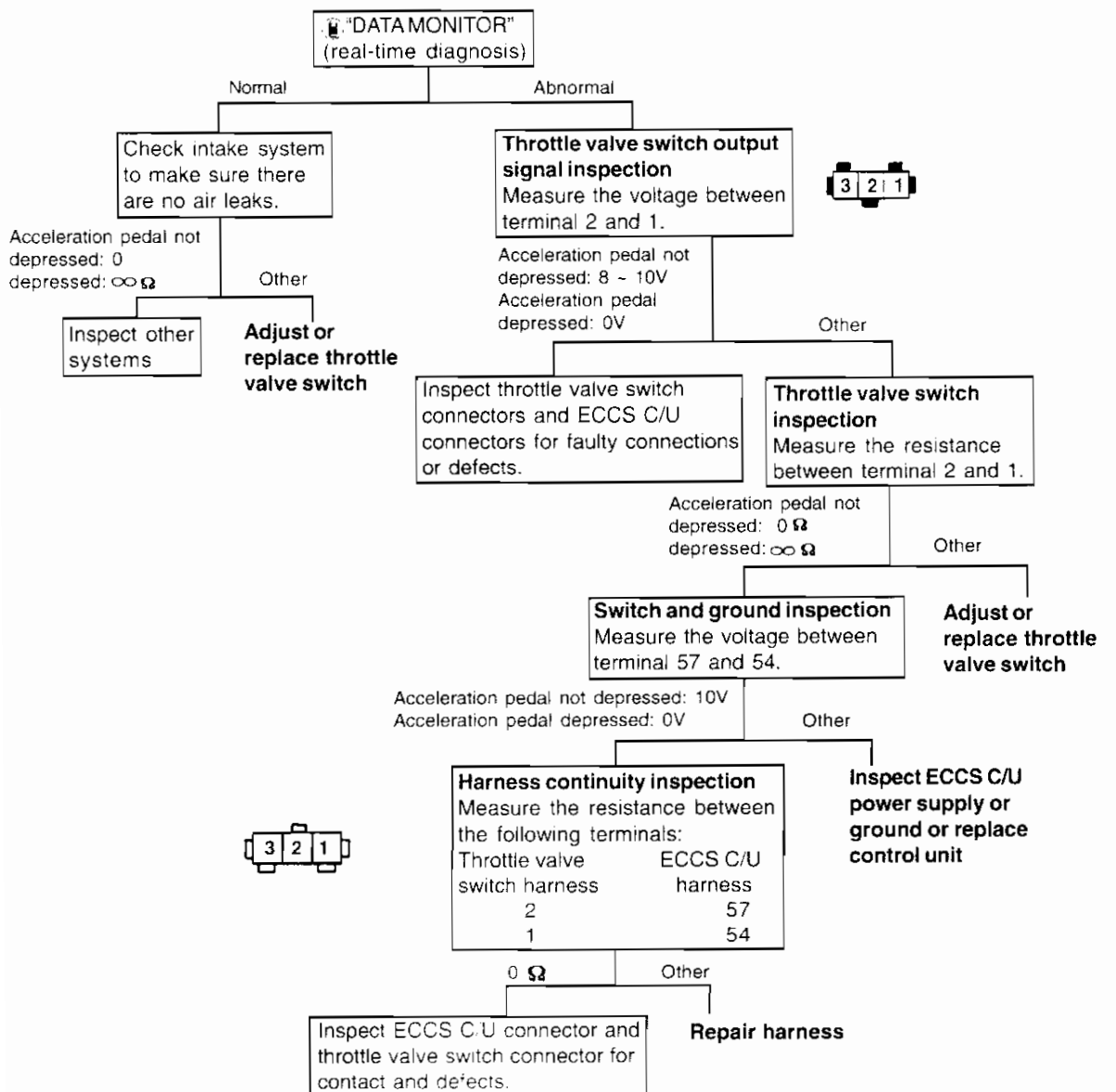

**6-3 THROTTLE VALVE SWITCH SYSTEM INSPECTION  
CONTROL CIRCUIT DIAGRAM RB20E / DE / DET ENGINE**

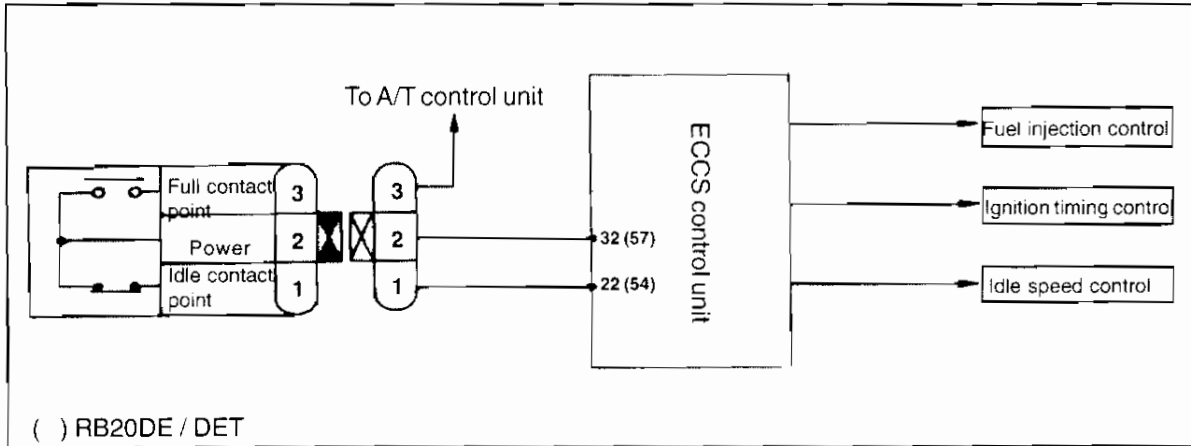

**Throttle valve switch system trouble diagnosis flowchart  
RB20E / DE / DET ENGINE**

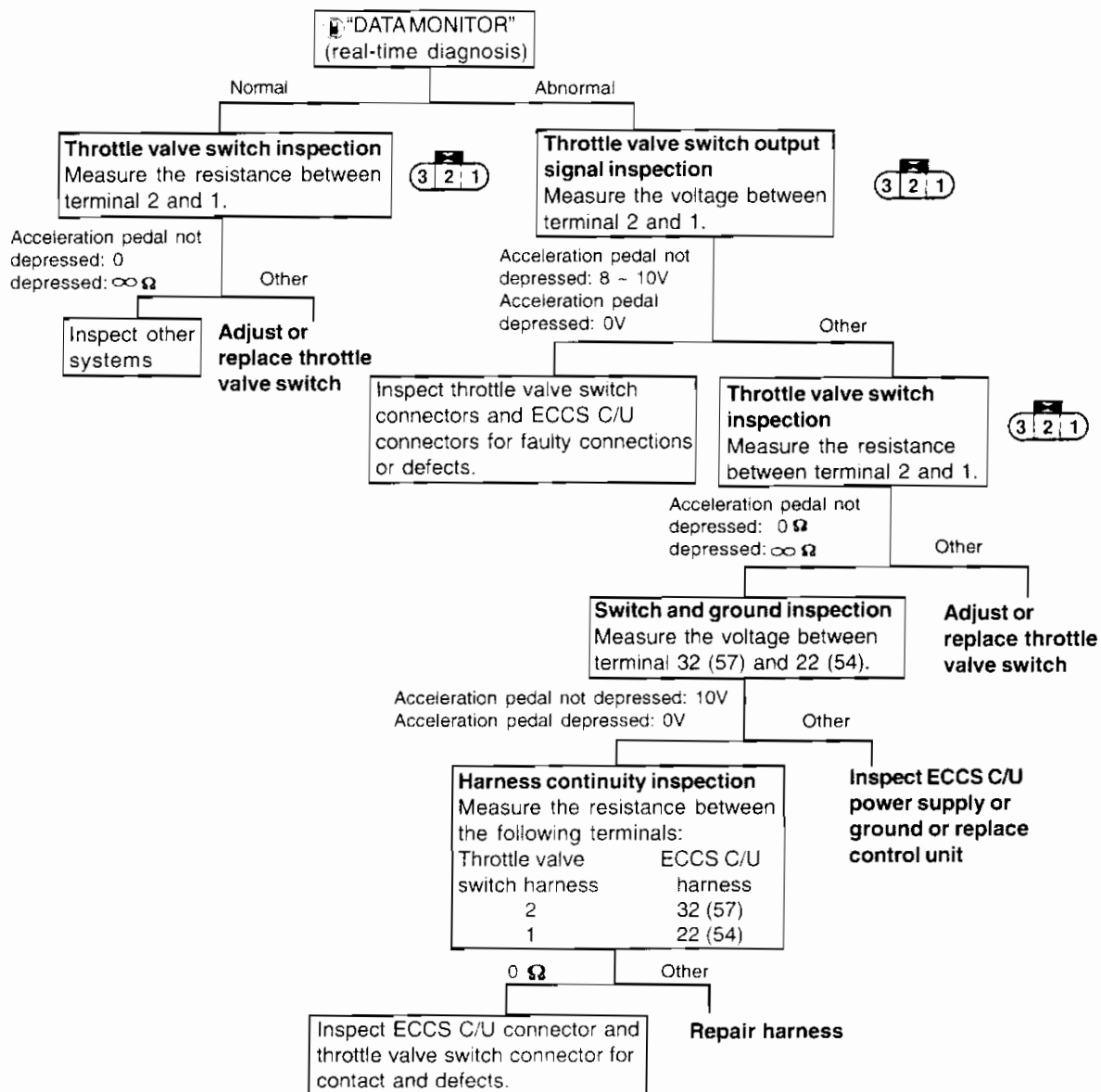

**(1) System inspection**

- Use "DATA MONITOR" to inspect idle contact point ON-OFF signal to make sure it is operating correctly.



**(2) Input signal inspection**

- Measure the voltage between the following terminals with ECCS control unit connector connected.

OR

- Measure the voltage between throttle valve switch connector terminal 2 and ground.

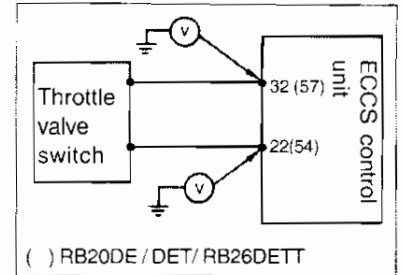

Engine		RB26DETT / RB20DE / DET	RB20E
<b>Measurement location</b>		Between ECCS C/U terminal 54 and ground (or between throttle valve switch terminal 1 and ground)	Between ECCS C/U terminal 22 and ground (or between throttle valve switch terminal 1 and ground)
<b>When ignition switch is ON or engine running</b>	When acceleration pedal not depressed (idle connection point ON)	8 ~ 10V	8 ~ 10V
	When acceleration pedal depressed (idle connection point OFF)	0V	0V
<b>Cranking</b>		Approx. 8V	Approx. 8V

- Measure the voltage between the following terminals with ECCS control unit connectors connected.



OR

- Measure the voltage between throttle valve switch connector terminal 2 and ground.

Engine	RB26DETT / RB20DE / DET	RB20E
<b>Measurement location</b>	Between ECCS C/U terminal 57 and ground (or between throttle valve switch terminal 2 and ground)	Between ECCS C/U terminal 32 and ground (or between throttle valve switch terminal 1 and ground)
<b>When ignition switch is ON</b>	8 ~ 10V	8 ~ 10V

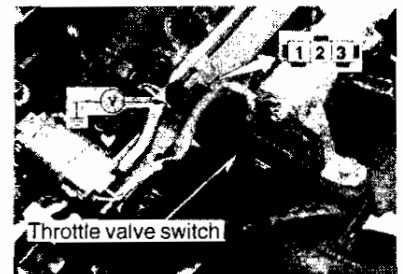

**(3) Throttle valve switch inspection (idle contact point)**

- Disconnect throttle valve switch connectors and measure the resistance between throttle valve switch terminals.

Engine	RB26DETT / RB20E / DE / DET
<b>Measurement location</b>	Between throttle valve switch terminals 2 and 1
<b>Acceleration pedal not depressed (idle connection point ON)</b>	0 Ω
<b>Acceleration pedal depressed (idle connection point OFF)</b>	∞ Ω

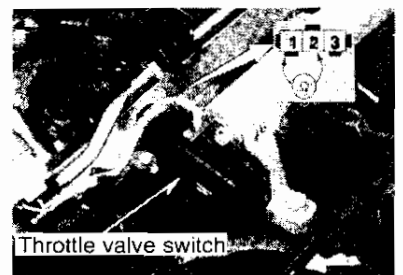

**(4) Harness continuity inspection**

- Disconnect throttle valve switch and ECCS control unit connectors and measure the resistance between the following terminals.

<b>RB26DETT / RB20DE / DET</b>	ECCS C/U	Throttle	0 Ω
	harness	valve switch	
	54	1	
	57	2	
<b>RB20E</b>	ECCS C/U	Throttle	0 Ω
	harness	valve switch	
	22	1	
	32	2	

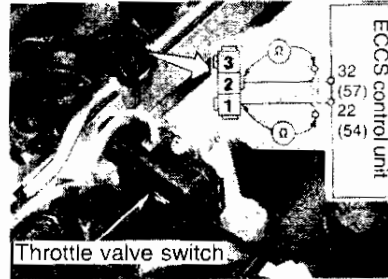

**(5) Idle contact point (touch speed) inspection and adjustment**

- Warm up the engine sufficiently and use "IDLE SW" in "OPERATION SUPPORT" mode to inspect idle contact point.



◆ Idle SW adj ◆

Lower CAS.RPM slowly from 2000rpm to idle and then check "touch RPM". Adjustment must be done after changing SW position.

START

- Disconnect AAC valve connector and inspect the unit when the AAC valve is fully open.



Engine	Idle contact point tachometer speed (rpm)
<b>RB26DETT</b>	1200 +/- 150
<b>RB20E</b>	850 +/- 150rpm
<b>RB20DE</b>	900 +/- 150
<b>RB20DET</b>	950 +/- 150

When the tachometer speed does not conform to the specified value, perform the adjustment as follows:

- Loosen throttle valve switch tightening bolts (2).
- Remove the throttle valve switch connectors, place a test probe between throttle valve switch terminals 1 and 2 and measure the resistance.
- Depress the accelerator pedal and gradually release the pedal to lower the engine speed. Rotate the throttle valve switch body and secure it in the position where the tachometer speed conforms to the specified value and the idle contact point is "ON" (the resistance between terminal 1 and 2 is 0 Ω).
- Tighten the throttle valve switch tightening bolts.
- Make sure the idle is ON observing by the tachometer speed as described above.
- Connect the throttle valve switch connectors.

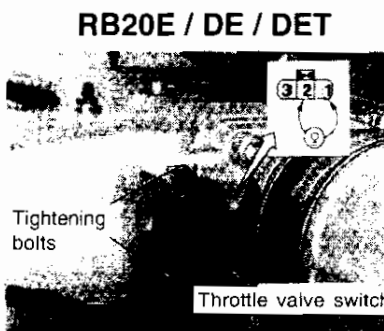
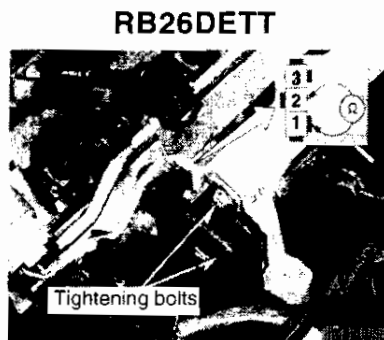

**6-4 THROTTLE SENSOR SYSTEM INSPECTION  
CONTROL CIRCUIT DIAGRAM RB26DETT ENGINE**

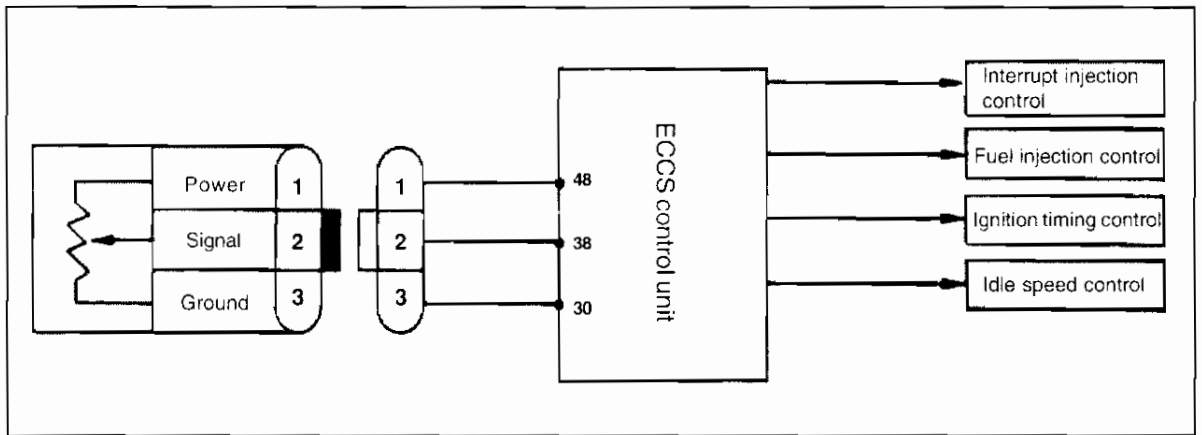

**Throttle sensor system trouble diagnosis flowchart RB26DETT ENGINE**

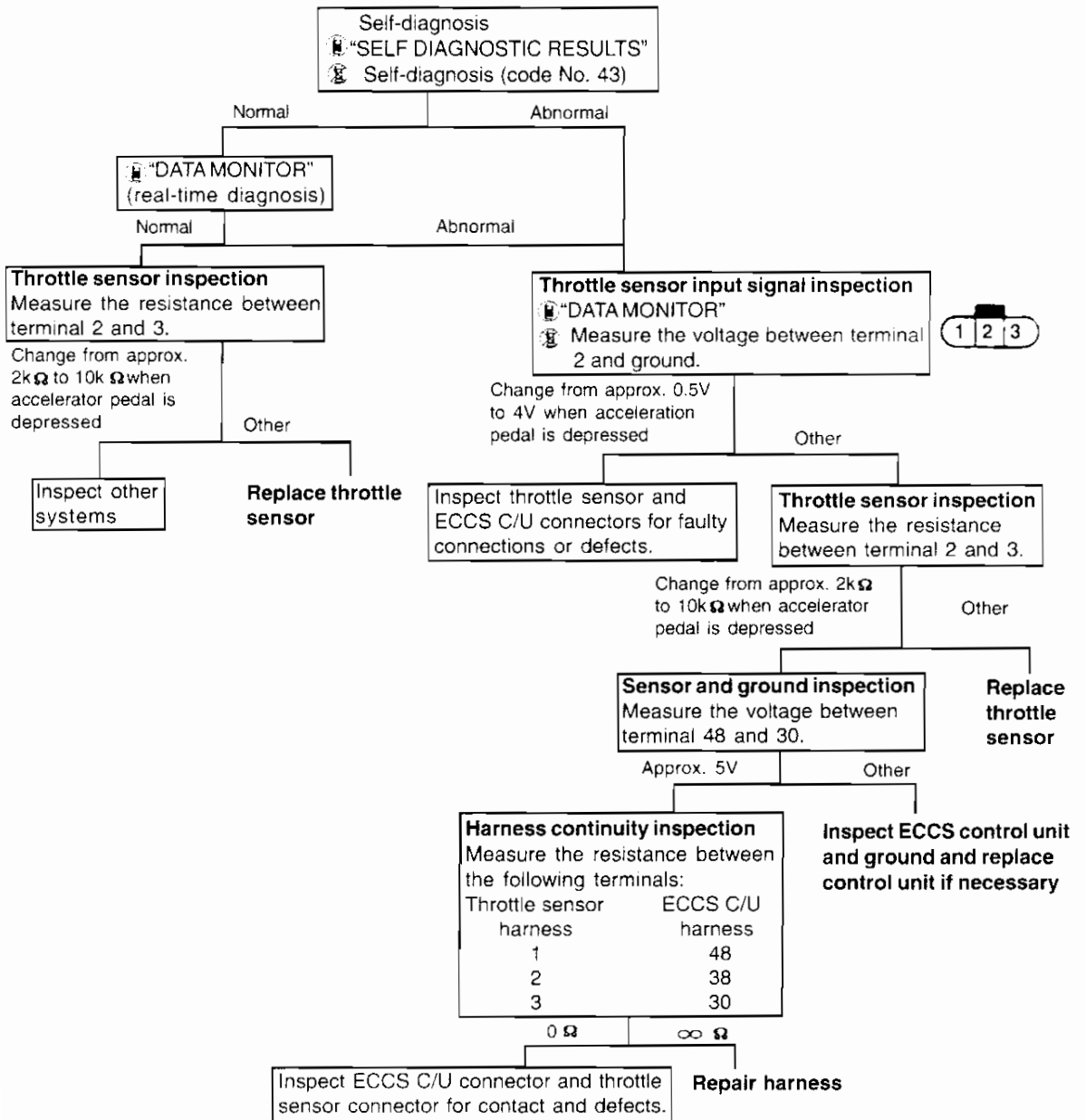

**6-4 THROTTLE SENSOR SYSTEM INSPECTION  
CONTROL CIRCUIT DIAGRAM RB20E / DE / DET ENGINE**

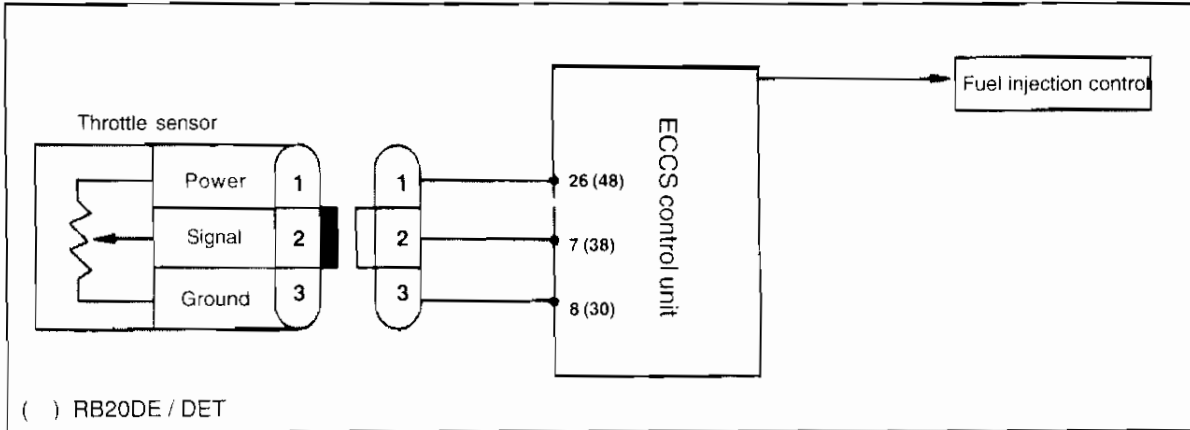

**Throttle sensor system trouble diagnosis flowchart RB20E / DE / DET ENGINE**

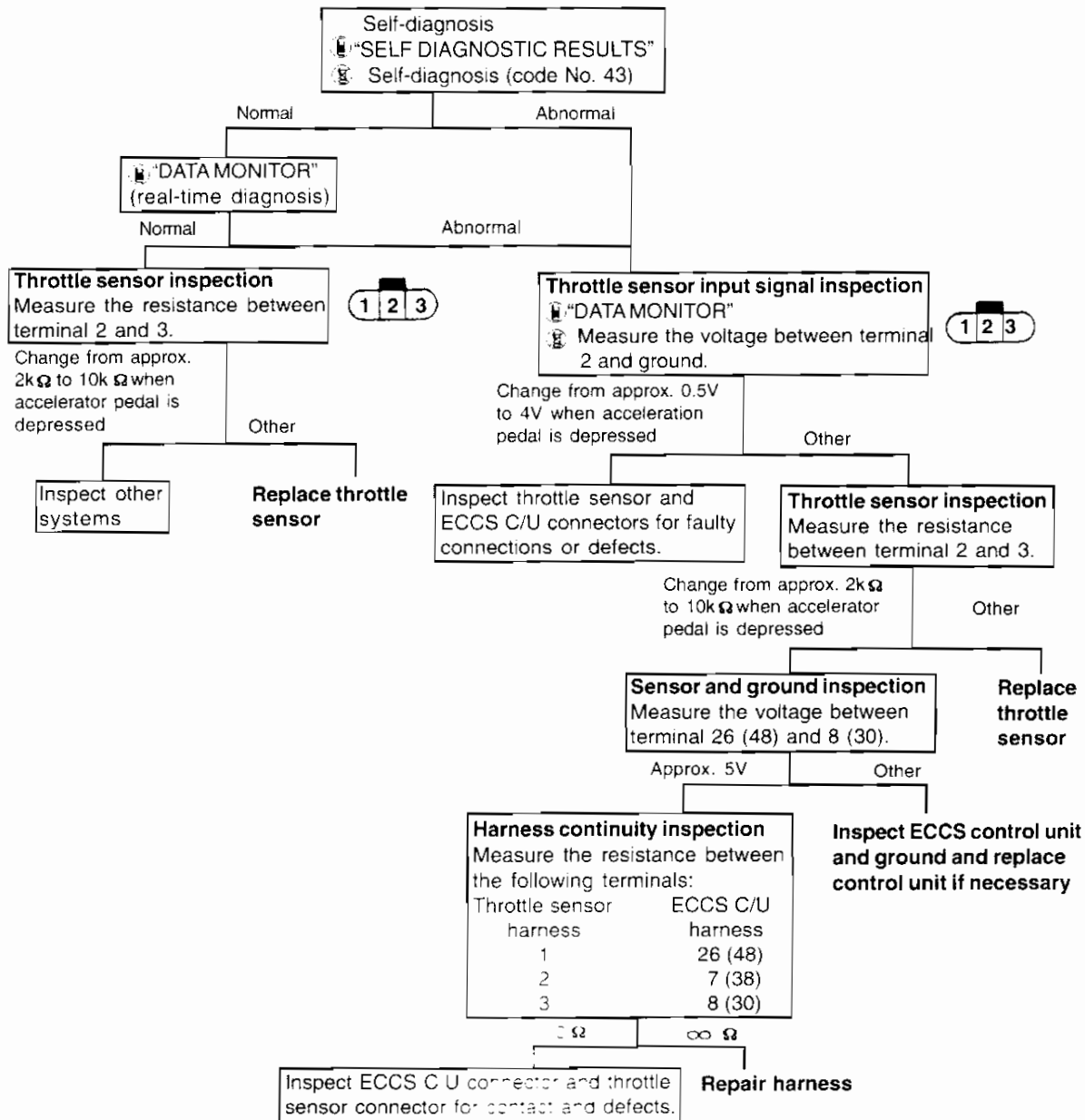

**(1) Self-diagnosis**

- There is a disconnection or short-circuit in the signal system when "CODE 43" is displayed in normal self-diagnosis (mode 2). When this is displayed, check the throttle sensor resistance or harness continuity, etc.

- If the problem occurs again, use real-time diagnosis mode or an oscilloscope to check for instantaneous break in the signal.



**(2) Input signal inspection**

- Use "THROTTLE SENSOR" setting in "DATA MONITOR" mode to check the following items:

Condition			RB26DETT / RB20E / DE / DET
Ignition switch ON	Accelerator pedal not depressed		Approx. 0.5V
	Accelerator pedal depressed	Half-way	0.5 ~ 4.0V
		Fully depressed	Approx. 4.0V

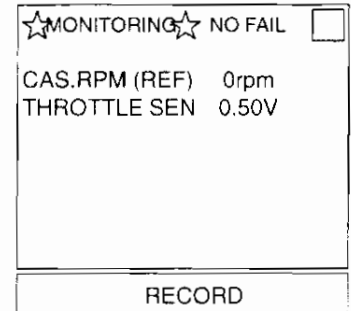

- Measure the voltage between the following terminals and ground with ECCS control unit connectors connected.

OR

- Measure the voltage between terminal 2 and ground with throttle sensor harness connected.

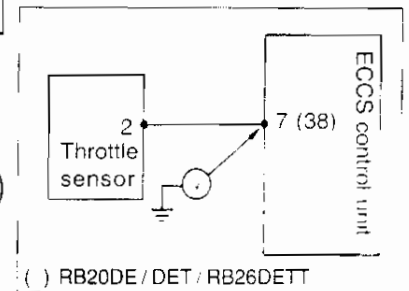

Engine	RB26DETT	RB20E	RB20DE / DET
<b>Measurement location</b>	ECCS C/U terminal 38 and ground (OR throttle sensor terminal 2 and ground)	ECCS C/U terminal 7 and ground (OR throttle sensor terminal 2 and ground)	ECCS C/U terminal 38 and ground (OR throttle sensor terminal 2 and ground)
<b>Ignition switch ON</b>	Approx. 0.5V	Approx. 0.2V	Approx. 0.2V
<b>Craning</b>	Approx. 0.5V	Approx. 0.2V	Approx. 0.2V
<b>Engine running</b>	<b>Acceleration pedal not depressed</b>	Approx. 0.5V	Approx. 0.5V
	<b>Acceleration pedal depressed</b>	0.5 ~ 4V	0.5 ~ 4V

**(3) Throttle sensor power supply inspection**

- Measure the voltage between the following terminals when throttle sensor connectors are connected.

Engine	RB26DETT / RB20E / DE / DET
<b>Measurement location</b>	Between throttle sensor terminal 1 and ground
<b>Ignition switch ON and engine running</b>	Approx. 5V

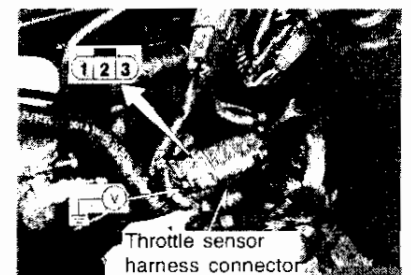

**(4) Throttle sensor unit inspection**

- Disconnect the throttle sensor connector and measure the resistance between the following terminals when the accelerator pedal is depressed and not depressed.

<b>Measurement location</b>	Between throttle sensor terminal 2 and 3
<b>Accelerator pedal not depressed</b>	Approx. 2K $\Omega$
<b>Accelerator pedal partially depressed</b>	Approx. 2K $\Omega$ ~ 10K $\Omega$ (Resistance will increase as pedal is pressed)
<b>Accelerator pedal fully depressed</b>	Approx. 10K $\Omega$



**(5) Harness continuity inspection**

- Disconnect ECCS control unit and throttle sensor connector and measure the resistance between the following terminals.

Measurement location	ECCS C/U harness	Throttle sensor harness	Resistance
	26 (48)	1	0 $\Omega$
	7 (38)	2	
	8 (30)	3	

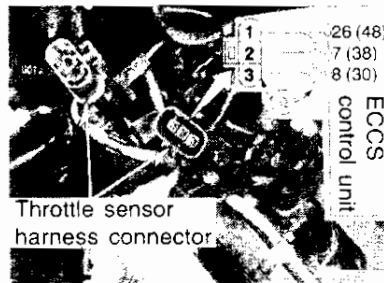

**(6) Throttle sensor inspection (RB26DETT)**

- Warm the engine adequately and check operation of the throttle sensor by using "THROTTLE SENSOR ADJUSTMENT" in "WORK SUPPORT" mode. (The throttle sensor can not be adjusted).

◆ THROTTLE SEN ADJ ◆

CHECK THE THROTTLE SENSOR SIGNAL AND ADJUST IT TO THE SPECIFIED VALUE BY ROTATING THE SENSOR BODY UNDER THE FOLLOWING CONDITION:

- IGN SW "ON"
- ENG NOT RUNNING
- ACC PEDAL KEPT OFF

**START**

◆ THROTTLE SEN ADJ ◆

ADJ MONITOR

THROTTLE SEN            0.50V

MONITOR

CAS.RPM (POS)            950rpm

IDLE POSITION              ON



**6-4 THROTTLE SENSOR SYSTEM INSPECTION  
CONTROL CIRCUIT DIAGRAM CA18i ENGINE**

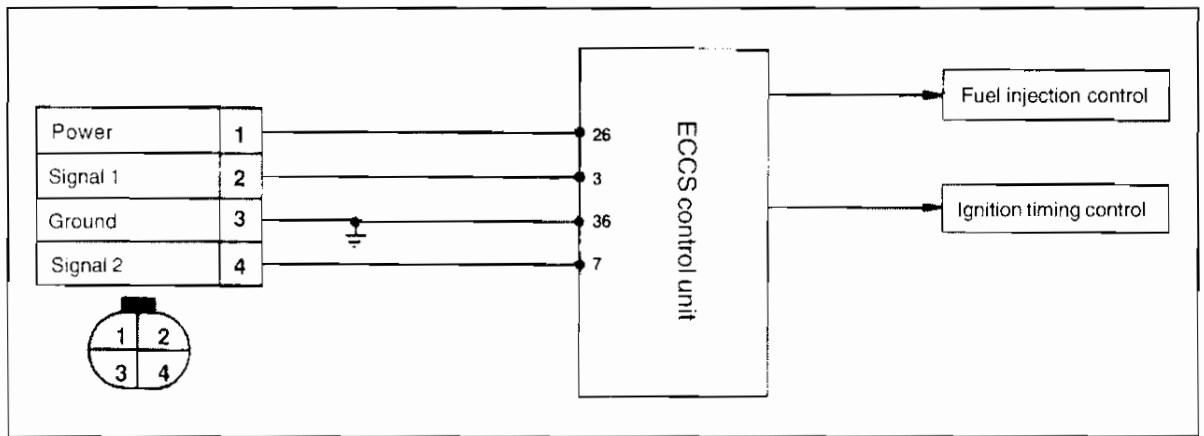

**Throttle sensor system trouble diagnosis flowchart CA18i ENGINE**

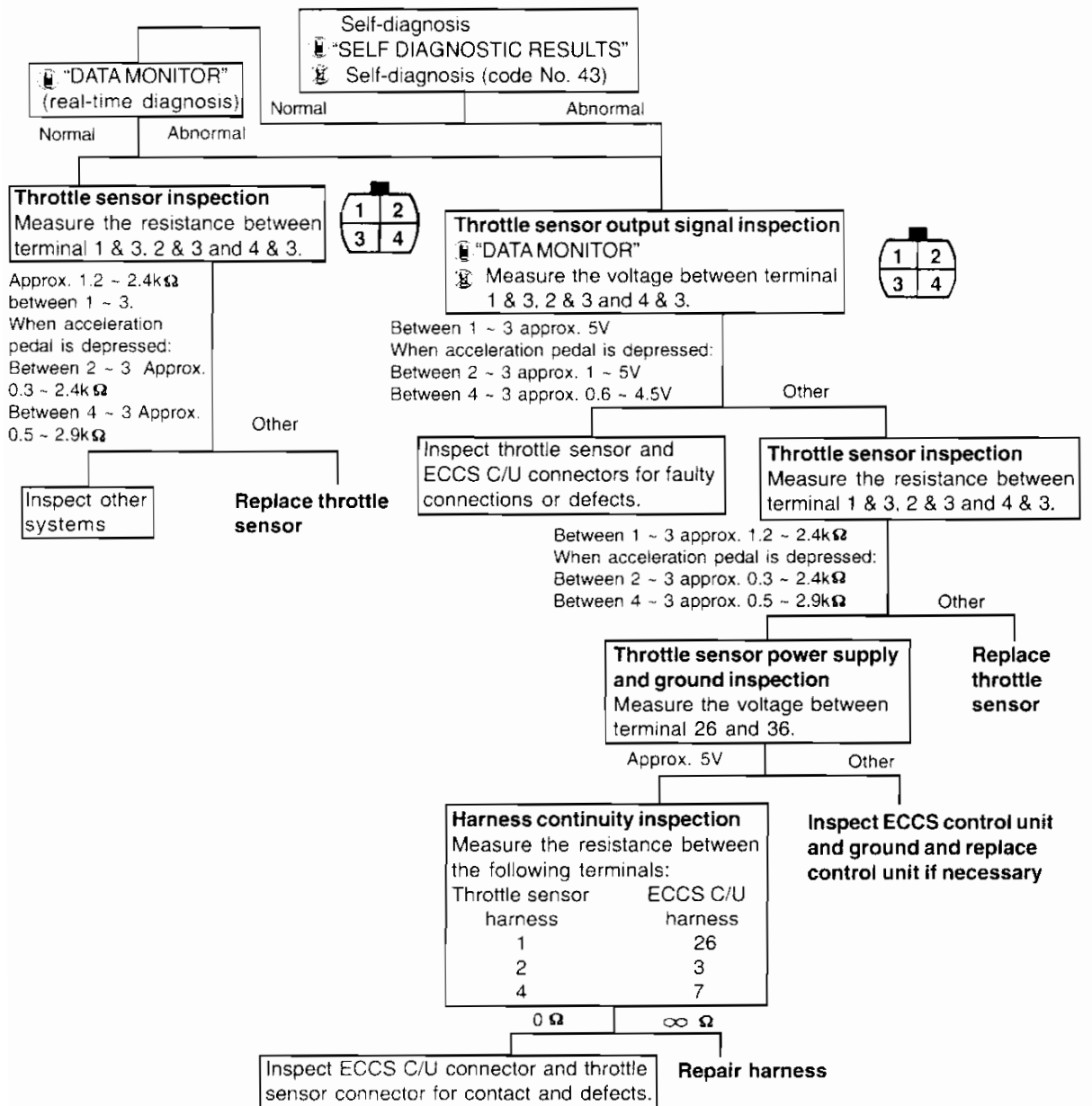

**(1) Self-diagnosis**

- There is a disconnection or short-circuit in the signal system when "CODE 43" is displayed in normal self-diagnosis (mode 2). When this is displayed, check the throttle sensor resistance or harness continuity, etc.
- If the problem occurs again, use real-time diagnosis mode or an oscilloscope to check for instantaneous break in the signal.



**(2) Input signal inspection**

- Use "THROTTLE SENSOR" and "THROTTLE SENSOR 2" setting in "DATA MONITOR" mode to check the following items:

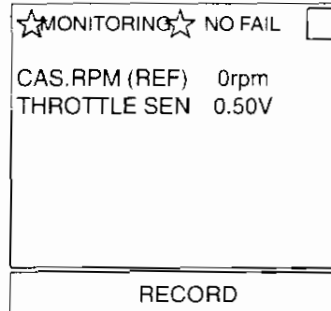

Condition		CA181		
		Throttle sensor	Throttle sensor 2	
Ignition switch ON	Accelerator pedal not depressed	1.0V	0.6V	
	Accelerator pedal depressed	Half-way	1.0 ~ 5.0V	0.6 ~ 4.5V
		Fully depressed	5.0V	4.5V

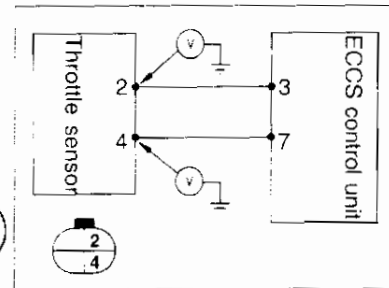

- Measure the voltage between the following terminals and ground with ECCS control unit connectors connected.



OR

- Measure the voltage between following terminals and ground with throttle sensor harness connected.

Engine		CA181	
Measurement location		ECCS C/U terminal 3 and ground (OR throttle sensor terminal 2 and ground)	ECCS C/U terminal 7 and ground (OR throttle sensor terminal 4 and ground)
Ignition switch ON	Acceleration pedal not depressed	Approx. 1V	Approx. 0.6V
	Acceleration pedal depressed	Approx. 1V ~ 5V	Approx. 0.6 ~ 4.5V

**(3) Throttle sensor power supply inspection**

- Measure the voltage between the following terminals when throttle sensor connectors are connected.

Engine	RB26DETT / RB20E / DE / DET
Measurement location	Between throttle sensor terminal 1 and ground
Ignition switch ON and engine running	Approx. 5V



**(4) Throttle sensor unit inspection (CA18i)**

- Disconnect the throttle sensor connector and measure the resistance between the following terminals.

Between throttle sensor terminal 1 and 3	Approx. 1.2 ~ 2.4 $\Omega$ *1
Between throttle sensor terminal 2 and 3	Changes between approx. 0.3 ~ 2.4K $\Omega$ when acceleration pedal is depressed *2
Between throttle sensor terminal 3 and 4	Changes between approx. 0.5 ~ 2.9K $\Omega$ when acceleration pedal is depressed *3

\*1 Normal if the value is within 0.3 ~ 2.4K. The value will not change even when the accelerator pedal is depressed.

\*2, 3 The value is not  $\infty \Omega$  and normal if the value changes when the accelerator pedal is depressed.

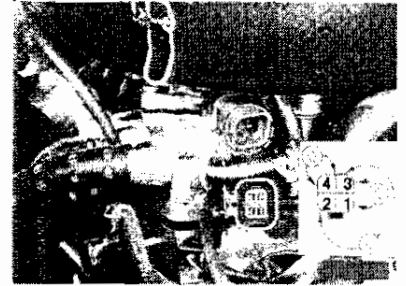

**(5) Harness continuity inspection (CA18i)**

- Disconnect ECCS control unit and throttle sensor connector and measure the resistance between the following terminals.

ECCS C/U harness	Throttle sensor harness	
3	2	0 $\Omega$
7	4	
26	1	

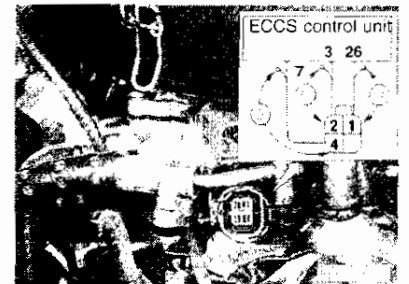

**6-5 INTAKE AIR TEMPERATURE SENSOR SYSTEM INSPECTION  
CONTROL CIRCUIT DIAGRAM RB26DETT ENGINE**

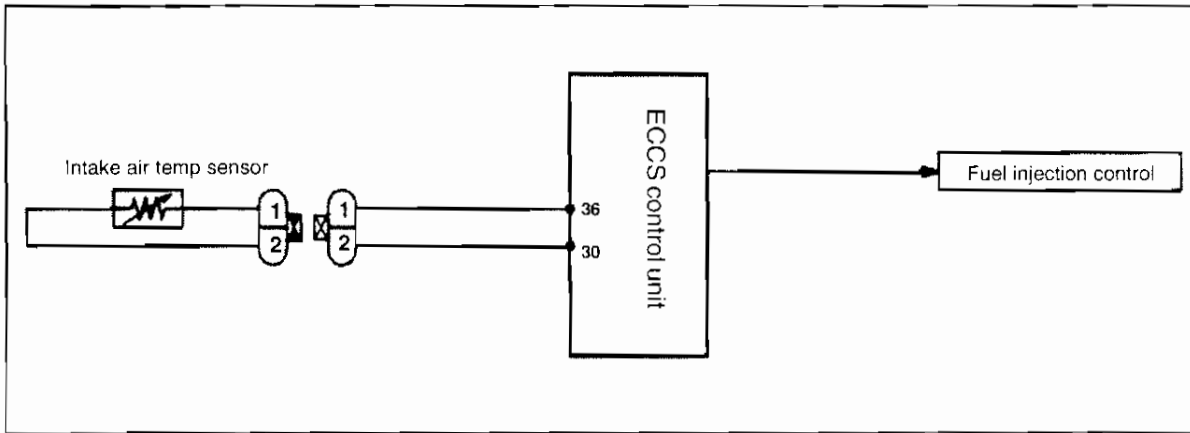

**Intake air temperature sensor system trouble diagnosis flowchart  
RB26DETT ENGINE**

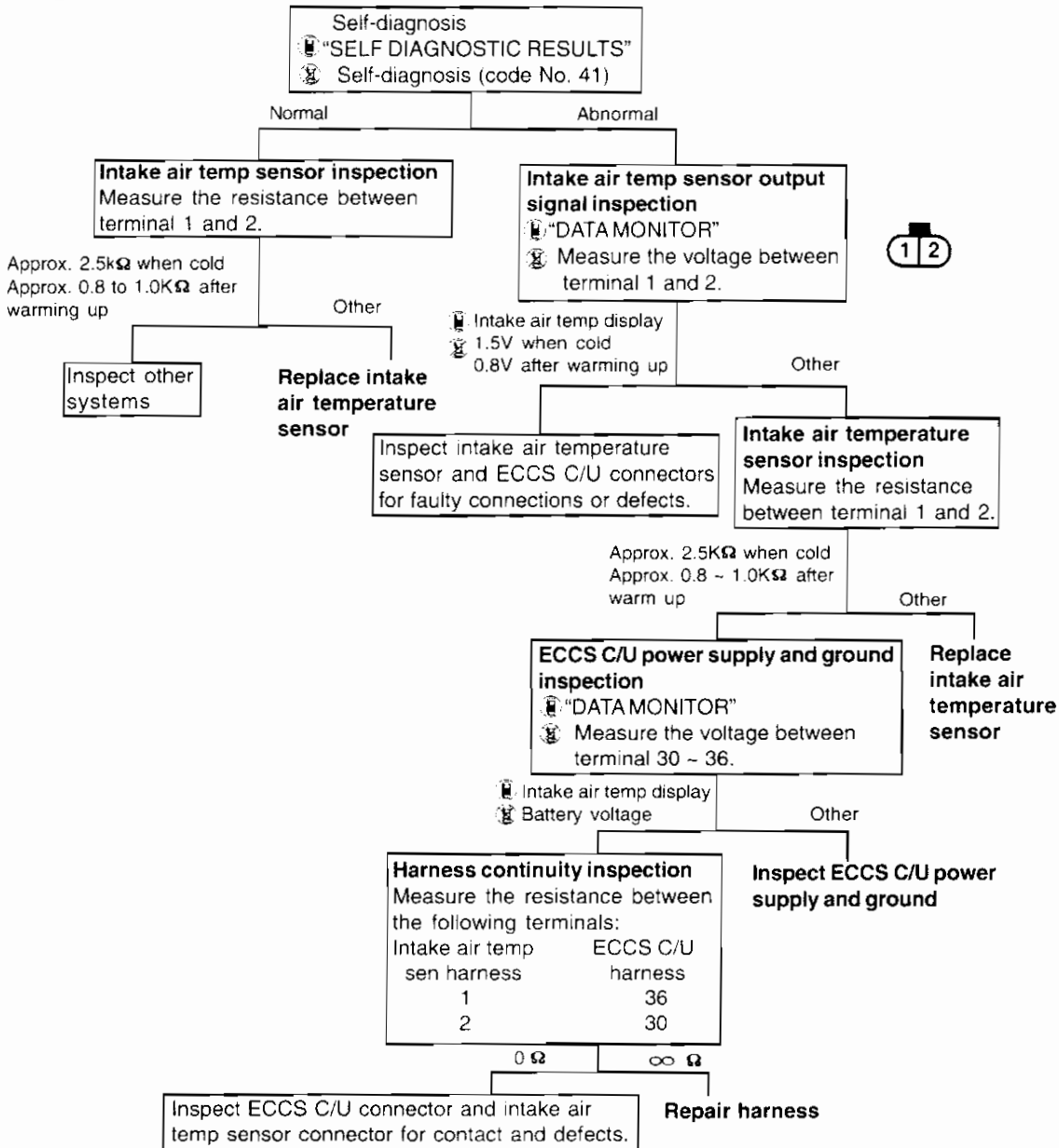

**6-5 INTAKE AIR TEMPERATURE SENSOR SYSTEM INSPECTION  
CONTROL CIRCUIT DIAGRAM CA18i ENGINE**

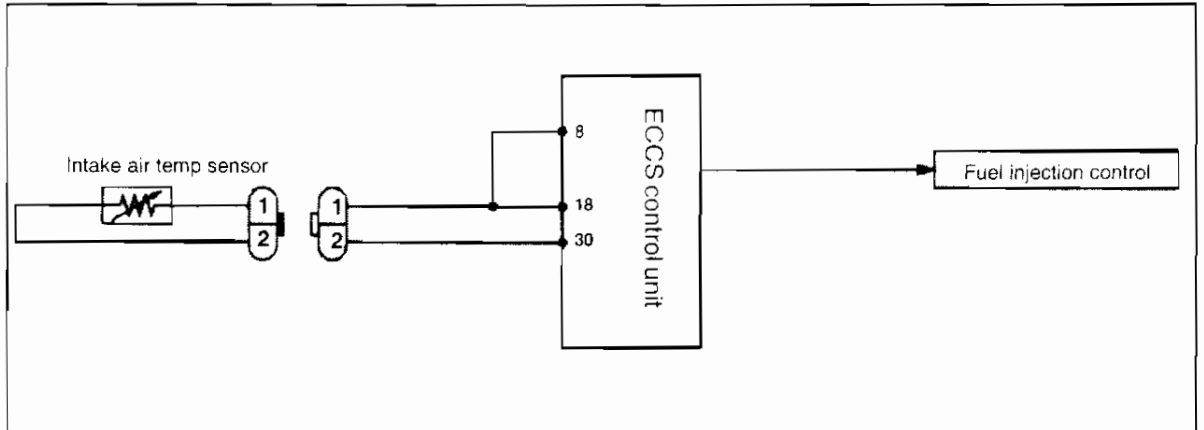

**Intake air temperature sensor system trouble diagnosis flowchart CA18i ENGINE**

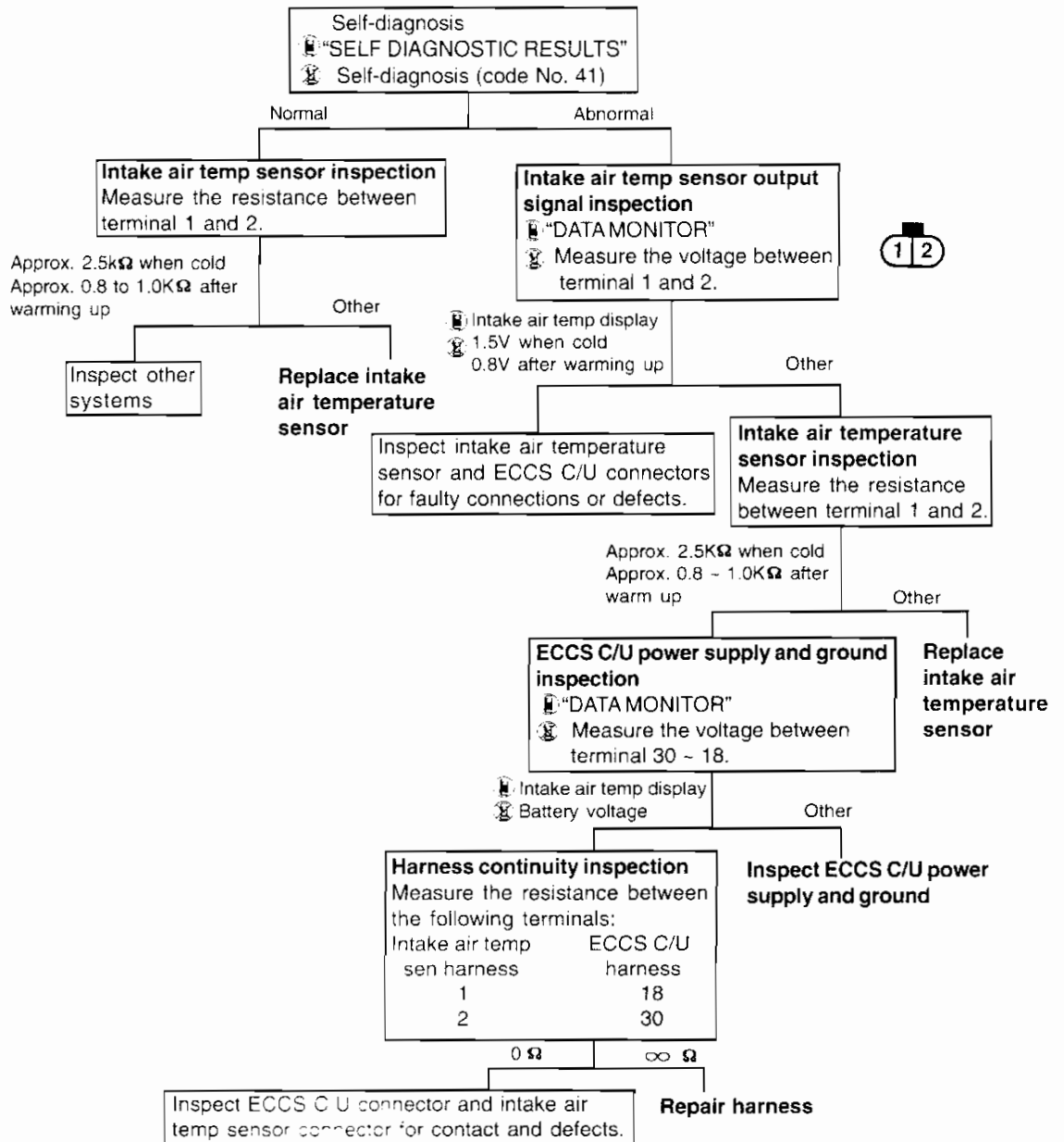

**(1) Self-diagnosis**

- There is a disconnection or short-circuit in the signal system when “CODE 41” is displayed in normal self-diagnosis or “FAILURE DETECTED IN T/A TEMP SEN” (when CONSULT is used) is displayed.
- If the problem occurs again, use real-time diagnosis mode or an oscilloscope to check for instantaneous break in the signal.

**(2) Input signal inspection**

- Use “INT/A TEMP SEN” in “DATA MONITOR” mode to check the following items:



Condition	Intake air temp sen
Ignition switch in ON	Temperature display corresponds to intake air temperature.
Idling	

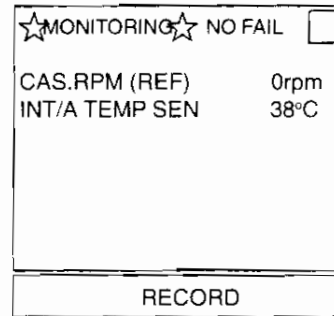

- Measure the voltage between the following terminals and ground with ECCS control unit connectors connected.



Condition	Measurement location	Between ECCS CU terminal 36 (30) and ground
Ignition switch OFF		0V
Ignition switch in ON	Approx 20°C	1.5V
	Approx 45°C	0.8V
Idling	Approx 20°C	1.5V
	Approx 45°C	0.8V

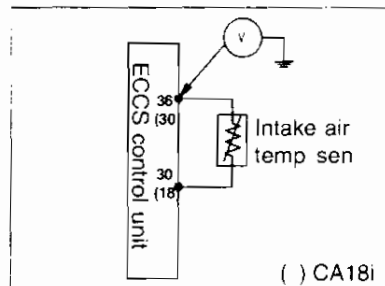

**(3) Harness continuity inspection**

- Disconnect ECCS control unit and intake air temperature sensor connector and measure the resistance between the following terminals. ( ) CA18i

ECCS C/U harness terminal 36 (30) and intake air temperature sensor 1	0 Ω
---	-----

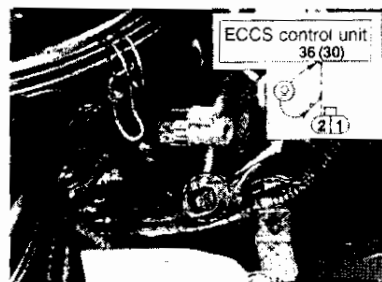

**(4) Intake air temperature sensor inspection**

- Disconnect intake air temperature sensor connector, heat or cool it with a hair dryer or industrial dryer and measure the resistance between the following terminals.

Condition	Between intake air temperature sensor terminal 1 and 2
Approx. 20°C	Approx. 2.5K Ω
Approx. 50°C	Approx. 0.8 ~ 1.0K Ω

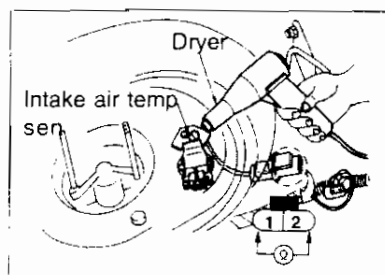

**6-6 ENGINE TEMPERATURE SENSOR SYSTEM INSPECTION  
CONTROL CIRCUIT DIAGRAM RB26DETT ENGINE**

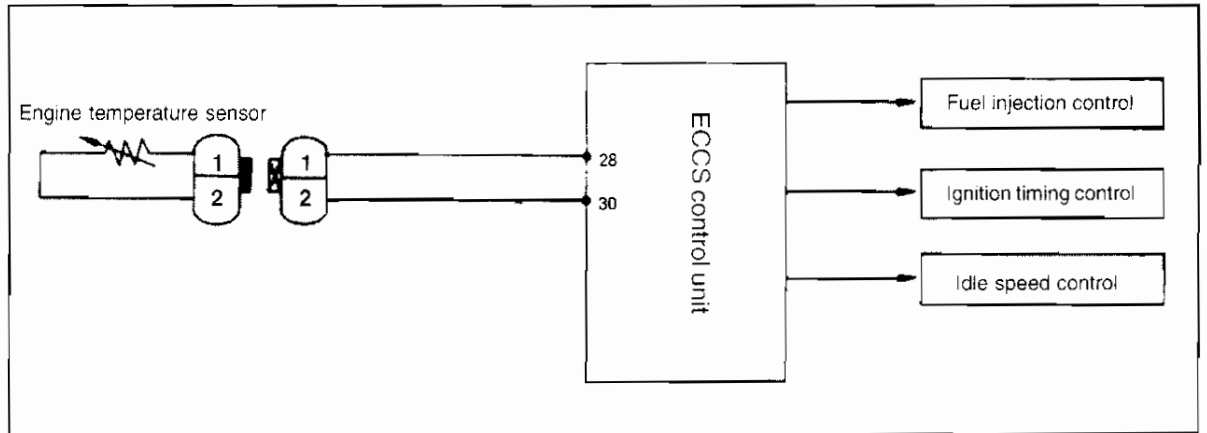

**Engine temperature sensor system trouble diagnosis flowchart  
RB26DETT ENGINE**

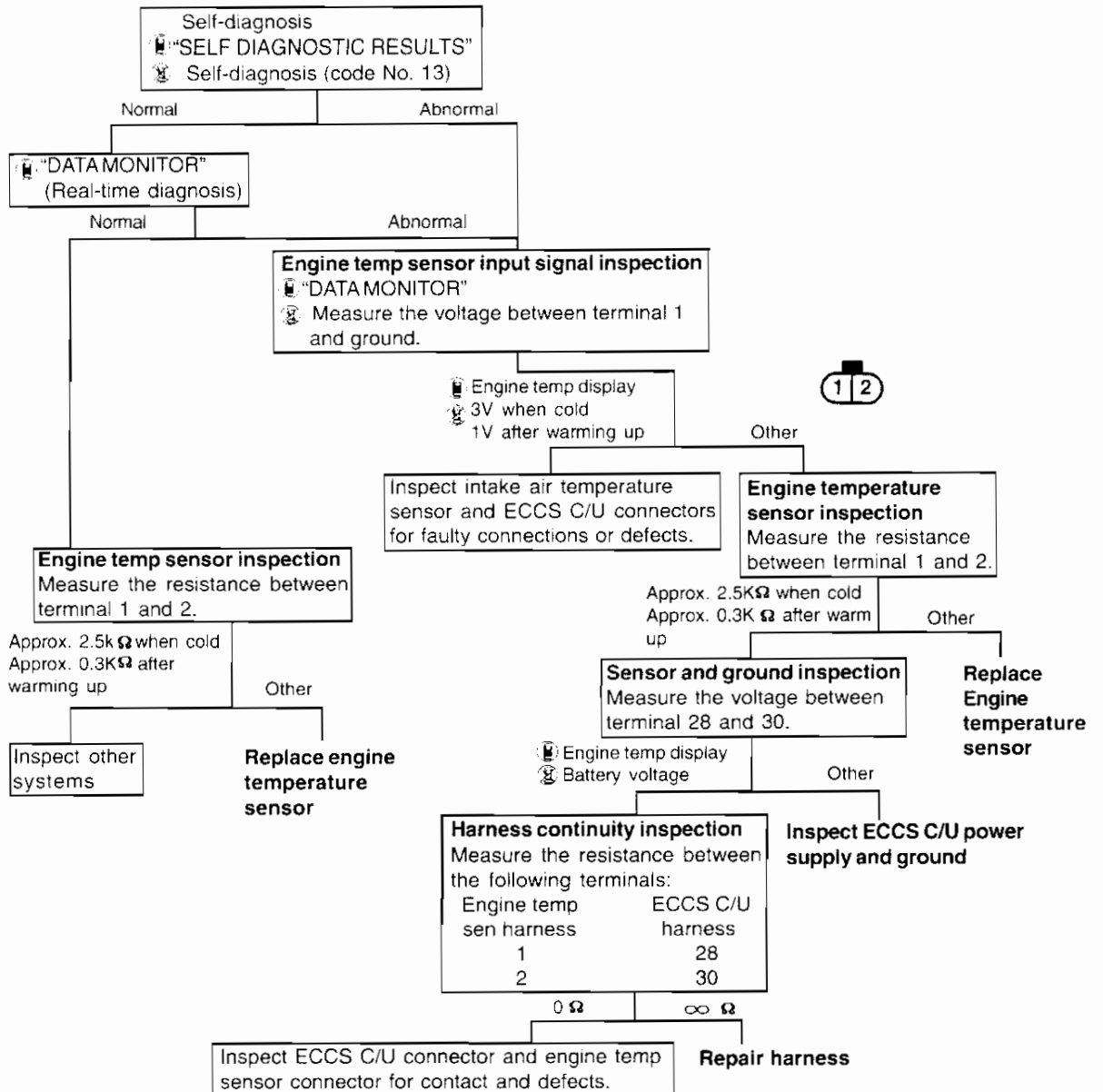

**6-6 ENGINE TEMPERATURE SENSOR SYSTEM INSPECTION  
CONTROL CIRCUIT DIAGRAM RB20E / DE / DET ENGINE**

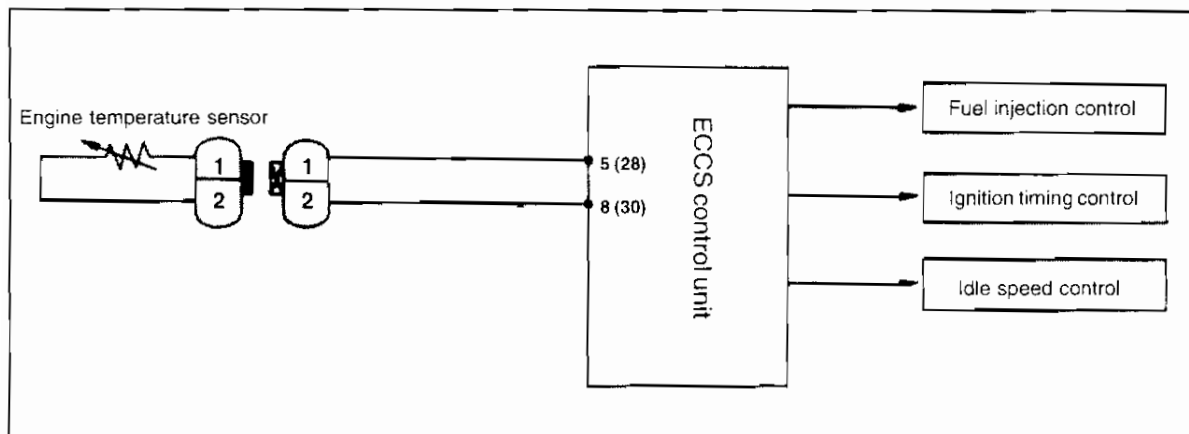

**Engine temperature sensor system trouble diagnosis flowchart  
RB20E / DE / DET ENGINE**

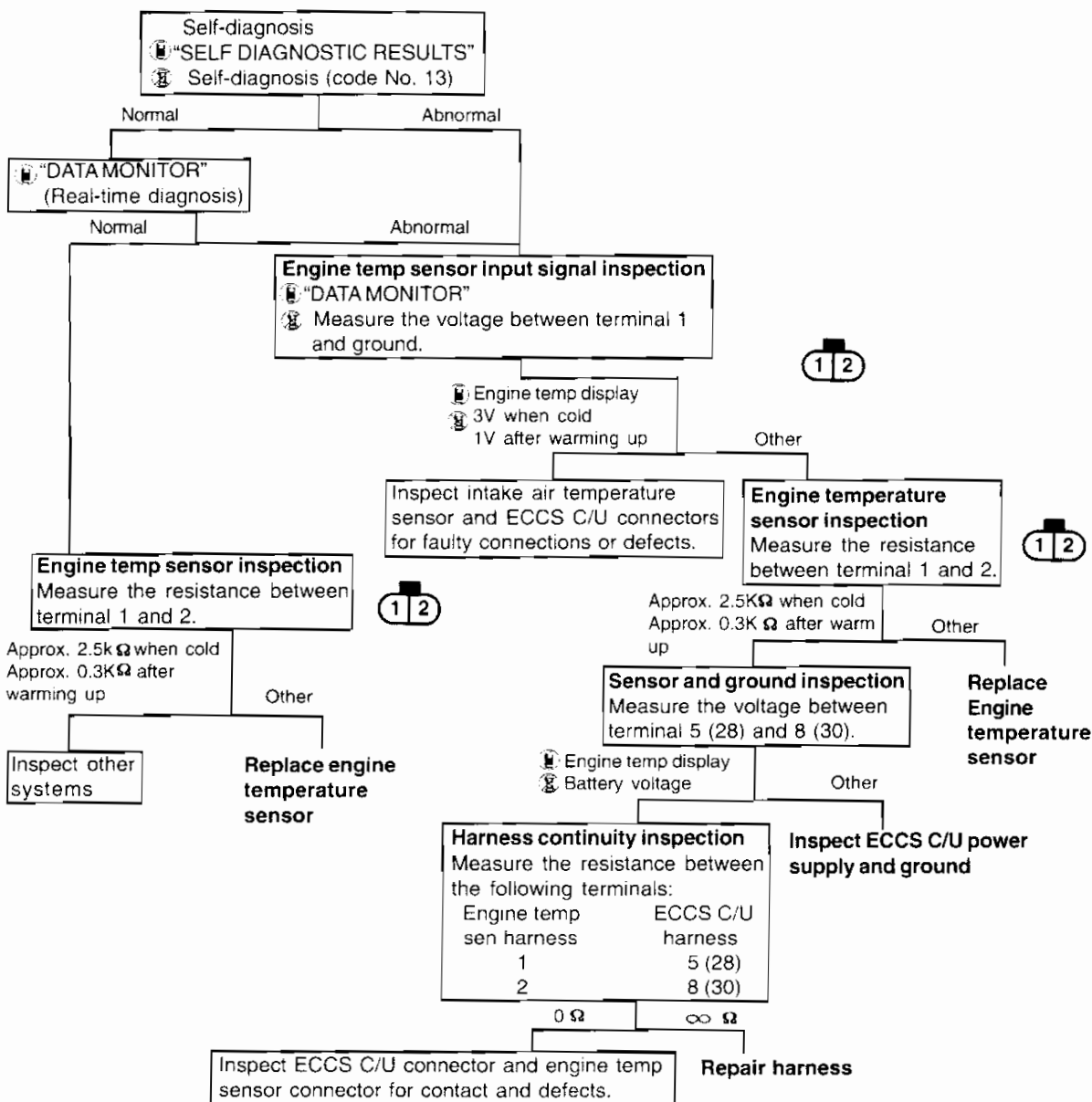





**(1) Self-diagnosis**

- There is a disconnection or short-circuit in the signal system when "CODE 13" is displayed in normal self-diagnosis or "FAILURE DETECTED ENG TEMP SEN" (when CONSULT is used) is displayed.
- If the problem reoccurs, use real-time diagnosis mode or an oscilloscope to check for instantaneous break in the signal.

**(2) Input signal inspection**

- Use "ENG TEMP SEN" in "DATA MONITOR" mode to check the following items:



Condition	Engine temperature sensor
Ignition switch ON	Engine temperature is displayed

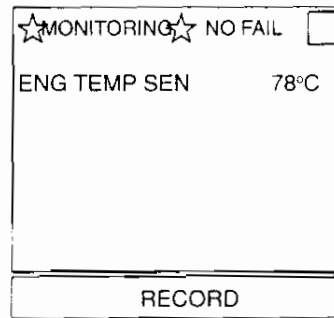

- Measure the voltage between the following terminals and ground with ECCS control unit connectors connected.



Engine			RB26DETT / RB20DE / DET	RB20E / CA18i
Measurement location			Between ECCS C/U terminal 28 and ground	Between ECCS C/U terminal 5 and ground
Ignition switch ON	Engine temp	Approx. 20°C	Approx. 3V	Approx. 3V
		Approx. 80°C	Approx. 1V	Approx. 1V

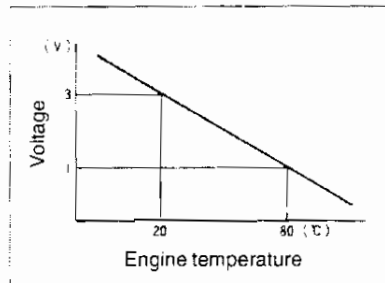
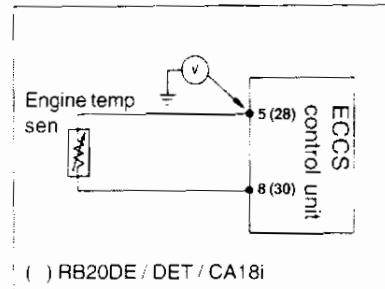

**(3) Engine temperature sensor resistance value inspection**

- Disconnect engine temperature sensor connector and measure the resistance between the following terminals.

Measurement location		Between engine temperature sensor connector 1 and 2
Engine temperature	Approx. 20°C	Approx. 2.5K
	Approx. 80°C	Approx. 0.3K

**RB20DE / DET**

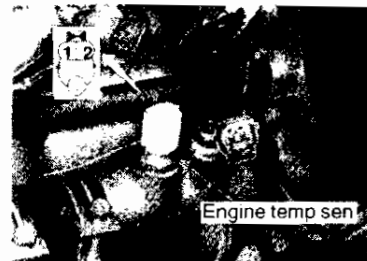

**CA18i**

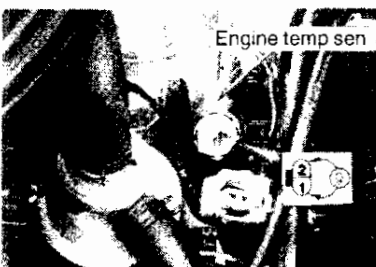

**RB20E**

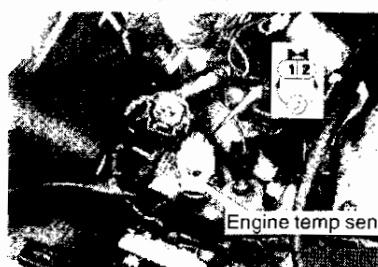

**RB26DETT**

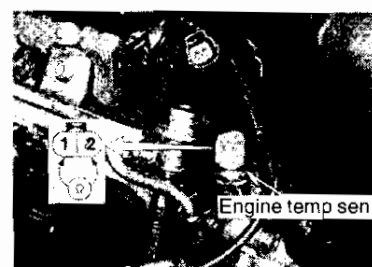

**(4) Harness continuity inspection**

- Disconnect ECCS control unit and engine temperature sensor harness connector and measure the resistance between the following terminals.

ECCS C/U harness	Engine temp sen harness	
5 (28)	1	0 Ω
8 (30)	2	

**RB20E / RB26DETT**

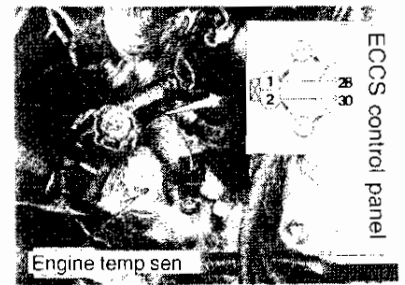

**CA18i / RB20DE / DET**

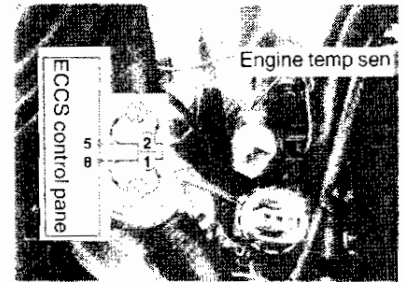

**6-7 EXHAUST GAS SENSOR SYSTEM INSPECTION  
CONTROL CIRCUIT DIAGRAM RB26DETT ENGINE**

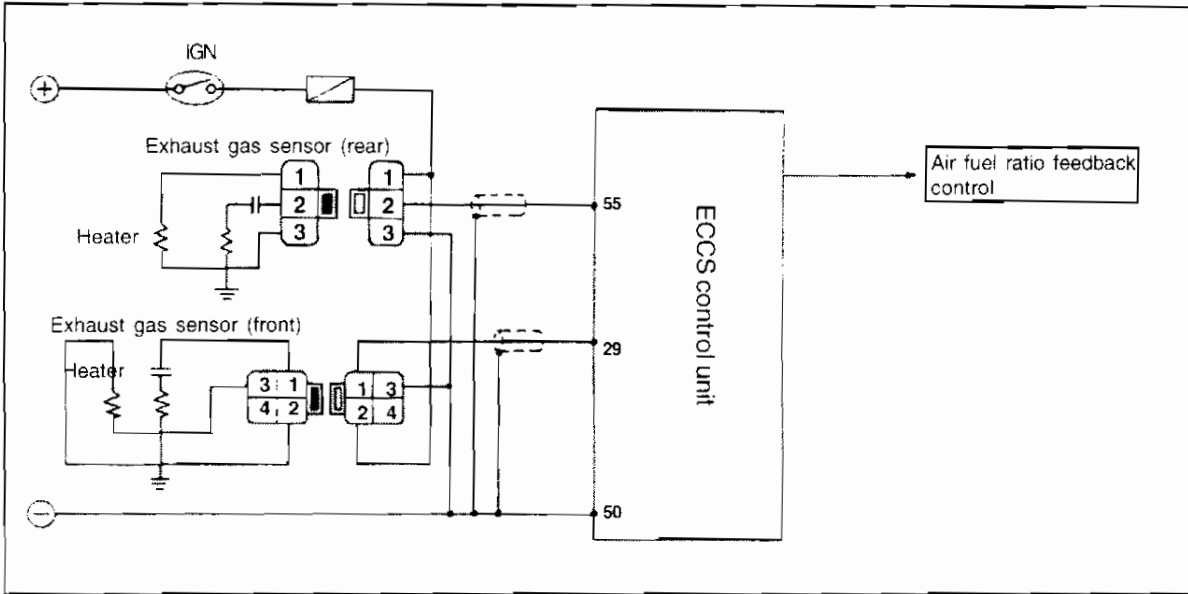

**Cylinder, exhaust gas sensor, CONSULT (data monitor) display**

Cylinder No.	O <sub>2</sub> sensor	ECCS C/U terminal No.	CONSULT (data monitor) display
No. 1, 2, 3 cyl	O <sub>2</sub> sensor (front)	ECCS C/U terminal 29	O <sub>2</sub> sensor (R)
No. 4, 5, 6 cyl	O <sub>2</sub> sensor (rear)	ECCS C/U terminal 55	O <sub>2</sub> sensor

**Exhaust gas sensor system trouble diagnosis flowchart RB26DETT engine**

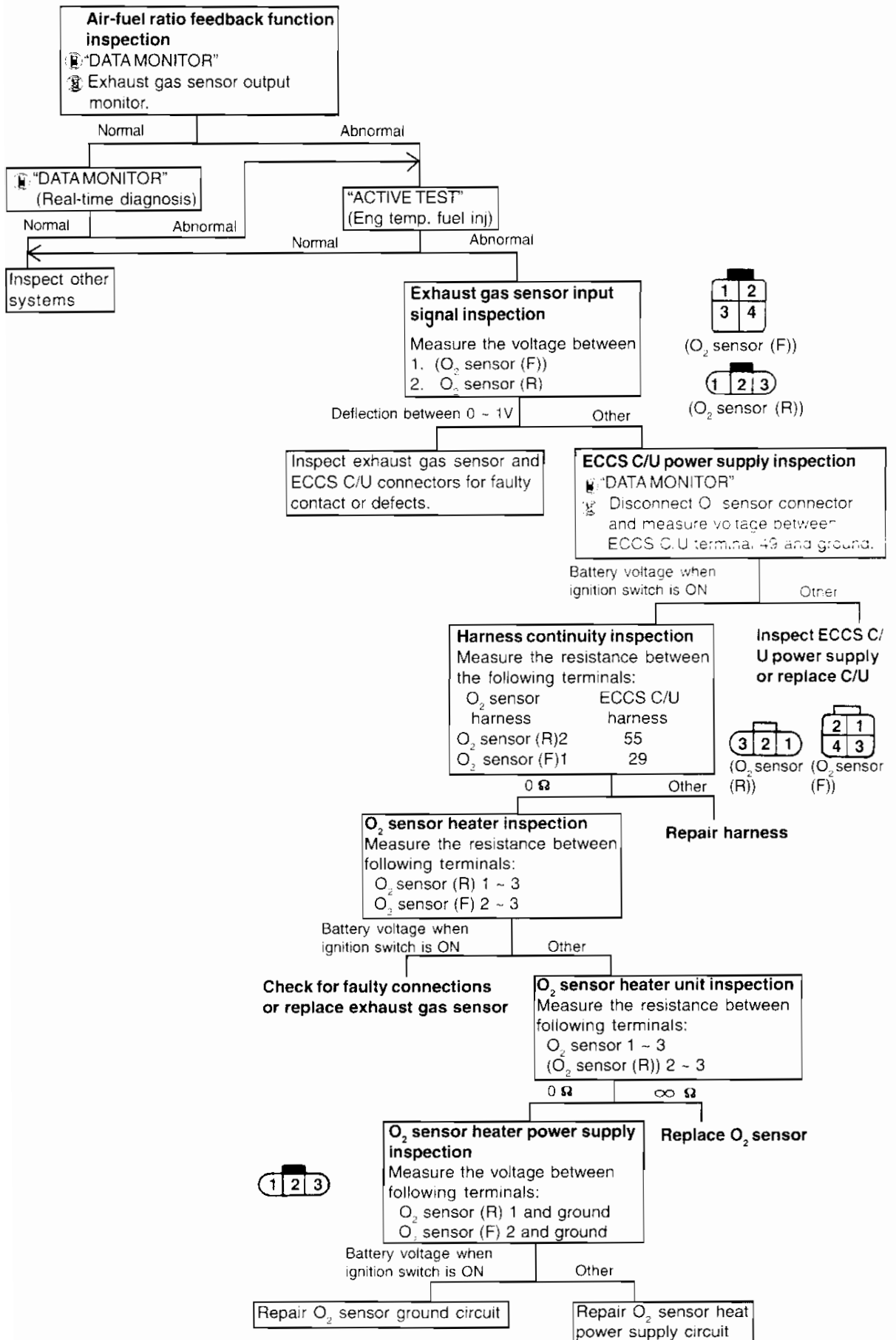

**(1) Fuel-air ratio feedback function inspection**

- Warm up the engine and check the following items with "EXH GAS SEN", "EXH GAS SEN-R" (output voltage), "M/R F/C MNT" and "M/R F/C MNT-R" (lean / rich) displayed in "DATA MONITOR" mode.



Item	O <sub>2</sub> sensor, O <sub>2</sub> sensor (R)	O <sub>2</sub> sensor monitor, O <sub>2</sub> sensor monitor (R)
Condition	(Output voltage display)	RICH, LEAN display
Engine speed at approx. 2,000 rpm	Approx. 0 ~ 1V is displayed. The display cycle is 5 times or more in 10 sec interval.	RICH, LEAN display must be synchronized with output voltage display.

★ MONITORING ★ NO FAIL <input type="checkbox"/>	
CAS.RPM (POS)	1975rpm
EXH GAS SEN	1.14V
EXH GAS SEN-R	1.03V
M/R F/C MNT	RICH
M/R F/C MNT	LEAN
RECORD	

- Provide setting value in "ACTIVE TEST" (fuel injection quantity correction) and check exhaust gas sensor function.

◆ ACTIVE TEST ◆ <input type="checkbox"/>			
FUEL INJECTION MONITOR 0%			
CAS.RPM (REF)	937rpm		
ENG TEMP SEN	59°C		
EXH GAS SEN	1.33V		
EXH GAS SEN-R	1.35V		
INJ PULSE	1.8msec		
AAC VALVE	17%		
Qu	UP	DWN	Qd

- Using diagnosis connector on the vehicle side (near fuse block), set CONSULT to "EXHAUST GAS SENSOR MONITOR" and check the fuel injection condition by flashing of exhaust gas temperature warning lamp on instrument panel.



**Exhaust gas sensor function**

Exhaust gas temperature warning lamp must flash 5 times or more in 10 seconds interval when engine is running at approx. 2,000 rpm.

**Feedback function**

Exhaust gas temperature warning lamp must flash periodically when engine speed is running at approx. 2,000 rpm.

**(2) Input signal inspection**

- Measure the voltage between the following terminals with ECCS control unit harness connected.

	Exhaust gas sen (front)	Exhaust gas sen (rear)
Measurement location	Between ECCS C/U terminal 29 and ground	Between ECCS C/U terminal 55 and ground
Racing at approx. 2,000rpm	Deflection between approx. 0 and 1V	Deflection between approx. 0 and 1V

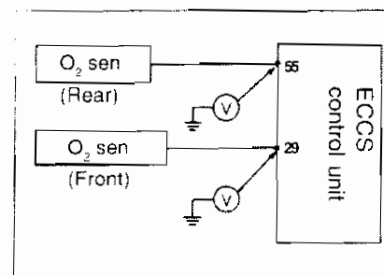

**(3) Harness continuity inspection**

- Disconnect ECCS control unit and exhaust gas sensor connectors and measure the resistance between the following terminals.

<b>O<sub>2</sub> sensor (Front)</b>	ECCS C/U harness terminal 29 and O <sub>2</sub> sensor harness terminal 1	0 Ω
<b>O<sub>2</sub> sensor (Rear)</b>	ECCS C/U harness terminal 55 and O <sub>2</sub> sensor harness terminal 2	0 Ω

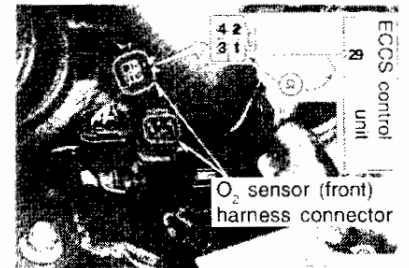
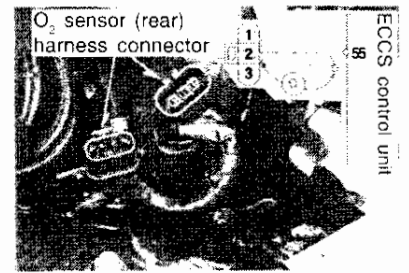

**6-7 EXHAUST GAS SENSOR SYSTEM INSPECTION  
CONTROL CIRCUIT DIAGRAM RB20E / DE / DET ENGINE**

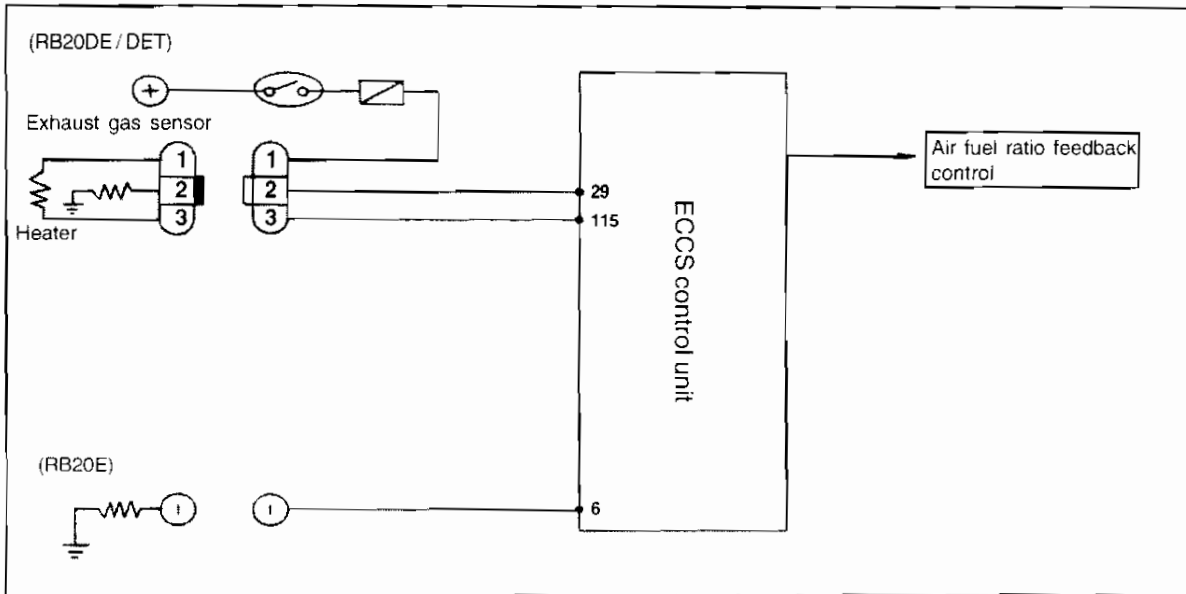



**Exhaust gas sensor system trouble diagnosis flowchart  
RB20E / DE / DET engine**

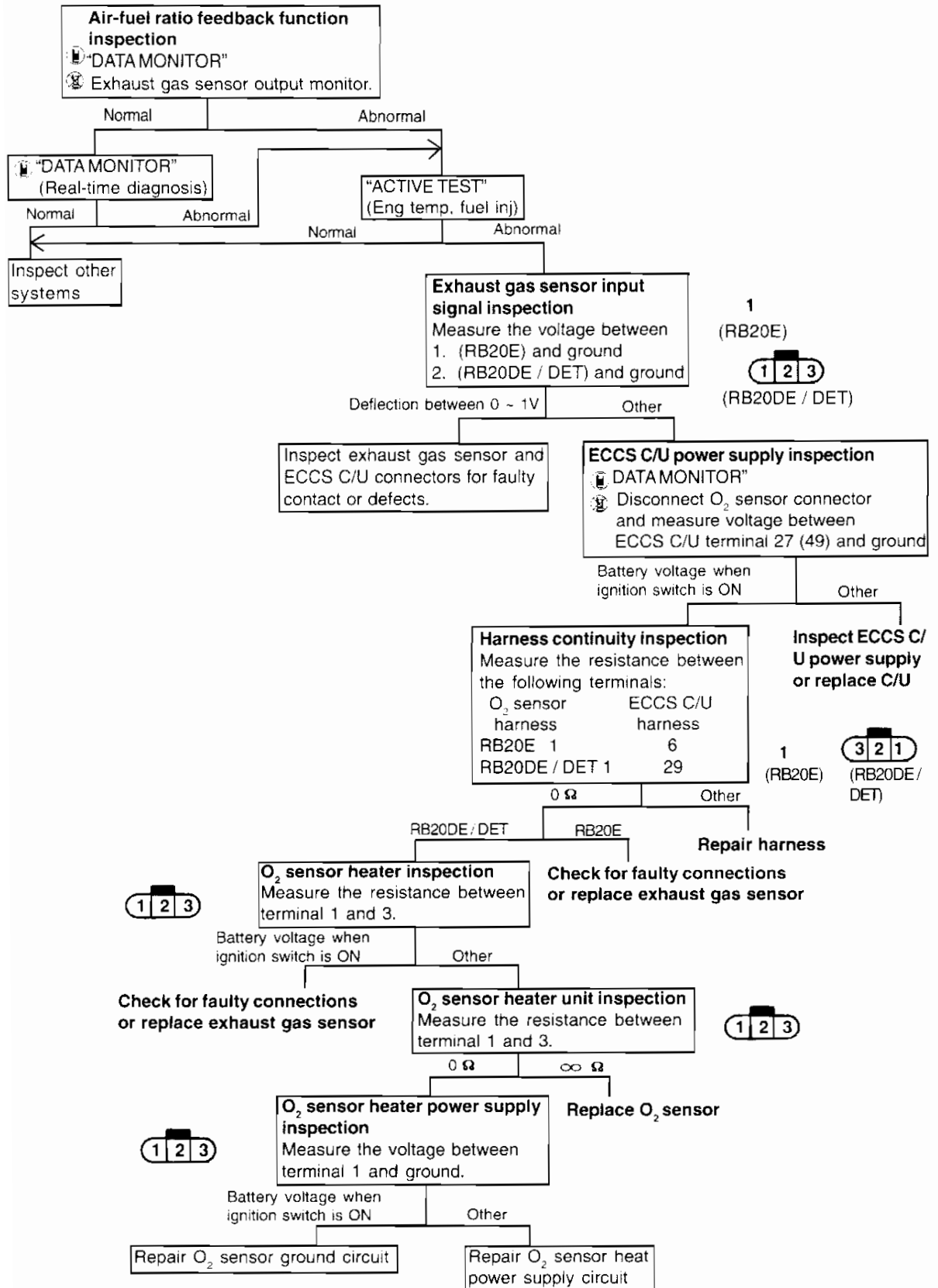

**6-7 EXHAUST GAS SENSOR SYSTEM INSPECTION  
CONTROL CIRCUIT DIAGRAM CA18i ENGINE**

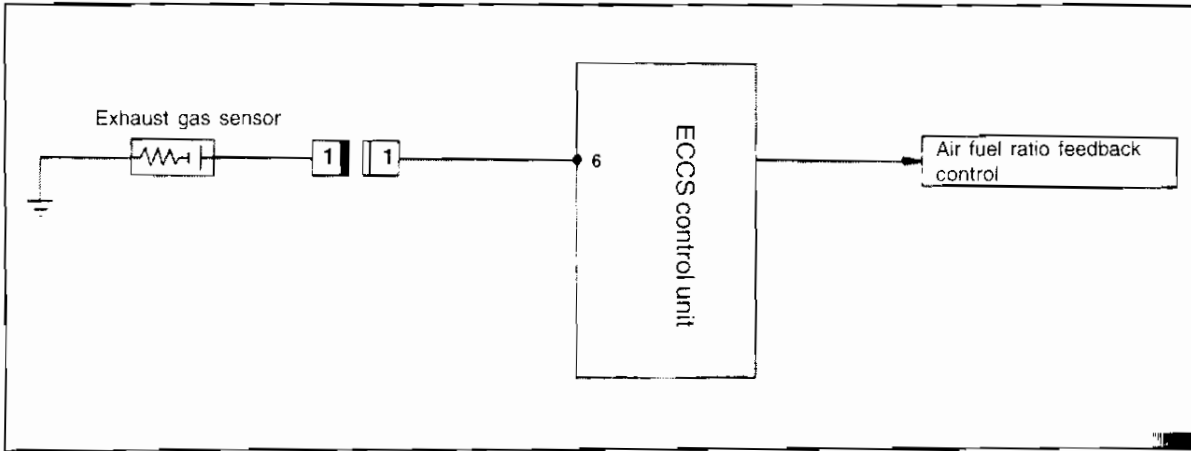

**Exhaust gas sensor system trouble diagnosis flowchart CA18i Engine**

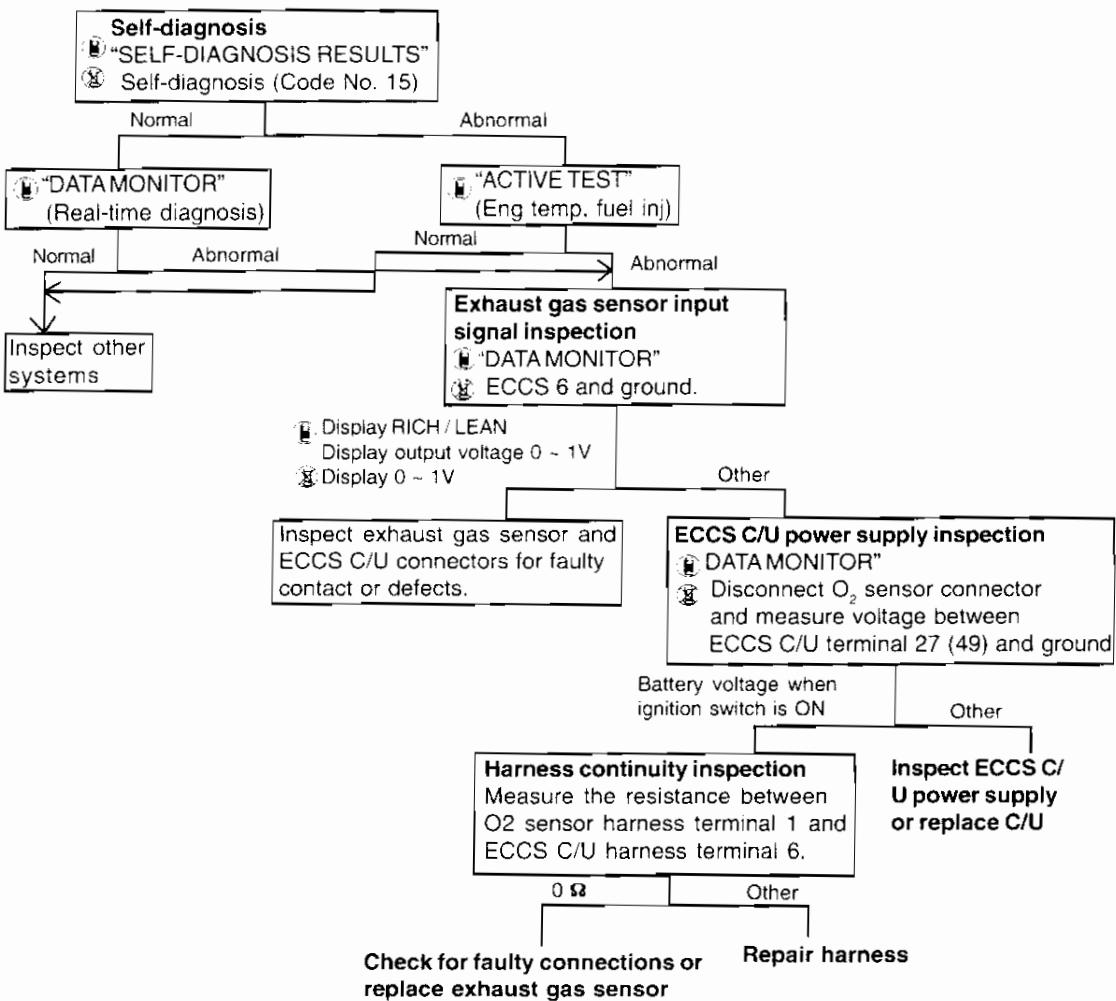

**(1) Fuel-air ratio feedback function inspection**

- Warm up the engine and check the following items with "EXH GAS SEN" and "M/R F/C MNT" (lean / rich) displayed in "DATA MONITOR" mode.



Item	Exhaust gas sen	Exhaust gas sen monitor
Condition	(Output voltage display)	RICH / LEAN display
Engine speed at approx. 2,000rpm	Approx. 0 ~ 1V is displayed. The display cycle is 5 times or more in 10 seconds interval.	RICH / LEAN display must be synchronized with output voltage display.

☆MONITORING☆	NO FAIL	<input type="checkbox"/>
CAS.RPM (POS)	2012rpm	
AIR FLOW MTR	1.54V	
ENG TEMP	80°C	
EXH GAS SEN	0.72V	
M/R F/C MNT	RICH	
RECORD		

- Provide setting value in "ACTIVE TEST" (fuel injection quantity correction) and check exhaust gas sensor function.

Note:

"INJ PULSE" display for RB20E is 1/16.

◆	ACTIVE TEST	◆	<input type="checkbox"/>
FUEL INJECTION		+11%	
MONITOR			
CAS.RPM (REF)	1037rpm		
ENG TEMP SEN	36°C		
EXH GAS SEN	0.87V		
INJ PULSE	4.0msec		
AAC VALVE	36%		
Qu	UP	DWN	Qd

- Using diagnosis connector on the vehicle side (near fuse block), set CONSULT to "EXHAUST GAS SENSOR MONITOR" and check the fuel injection condition by flashing of exhaust gas temperature warning lamp on instrument panel.



**Exhaust gas sensor function**

Exhaust gas temperature warning lamp must flash 5 times or more in 10 seconds interval when engine is running at approx. 2,000 rpm.

**Feedback function**

Exhaust gas temperature warning lamp must flash periodically when engine speed is running at approx. 2,000 rpm.

**(2) Input signal inspection**

- Measure the voltage between the following terminals with ECCS control unit harness connected.

Engine	RB20E / CA18i	RB20DE / DET
Measurement location	Between ECCS C/U terminal 1 and ground	Between ECCS C/U terminal 29 and ground
Racing at 2,000 rpm	Deflection between approx. 0 ~ 1	Deflection between approx. 0 ~ 1

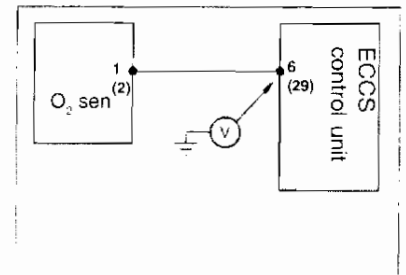

**(3) Harness continuity inspection**

- Disconnect ECCS control unit and exhaust gas connectors and measure the resistance between the following terminals.

Engine	Measurement location	
RB20E / CA18i	ECCS C/U harness terminal 6 and O <sub>2</sub> sensor harness terminal 1	0
RB20DE / DET	ECCS C/U harness terminal 29 and O <sub>2</sub> harness terminal 2	

**RB20E**

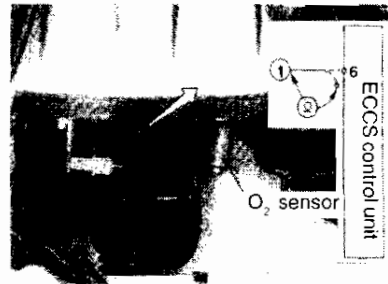

**RB20DE / DET**

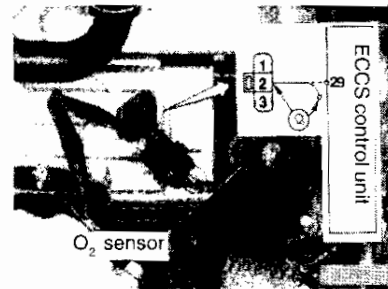

**RB20DE / DET**

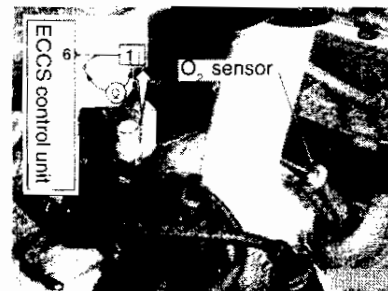

**6-8 DETONATION SENSOR SYSTEM INSPECTION  
CONTROL CIRCUIT DIAGRAM RB26DETT ENGINE**

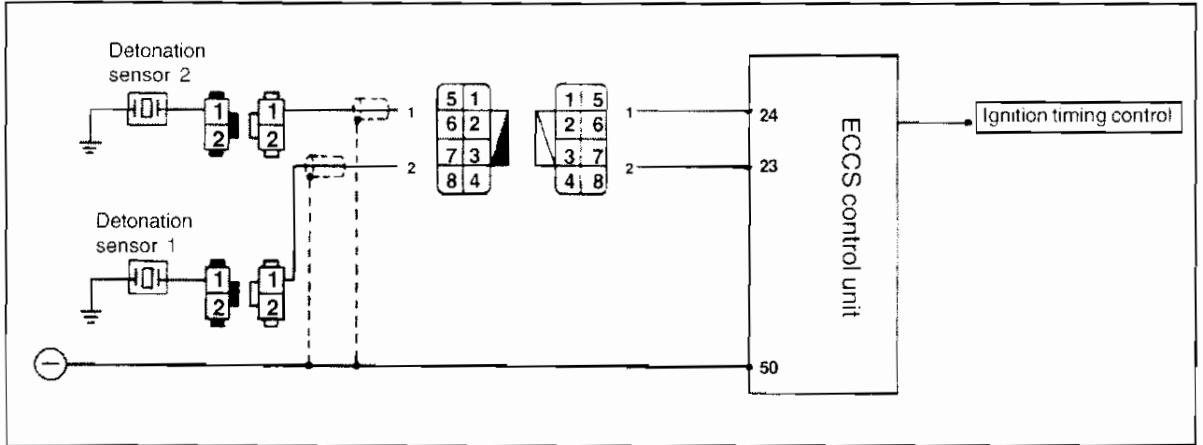

**(1) Self-diagnosis**

- There is a disconnection or short-circuit in the signal system when "CODE 34" in normal self-diagnosis or "FAILURE DETECTED DETONATION SENSOR" (when CONSULT is used) is displayed. If the problem occurs again, use real-time diagnosis mode (CONSULT DATA MONITOR mode) or an oscilloscope to check for instantaneous break in the signal.

**(2) Input signal inspection**

- Measure the voltage between the following terminals with ECCS control unit harness connected.

Engine	RB26DETT	
	Between ECCS C/U terminal 23 and ground	Between ECCS C/U terminal 24 and ground
Ignition switch is ON	Approx. 0.3V	Approx. 0.3V
Cranking	Approx. 0.3V	Approx. 0.3V
Idling	Approx. 0.3V	Approx. 0.3V

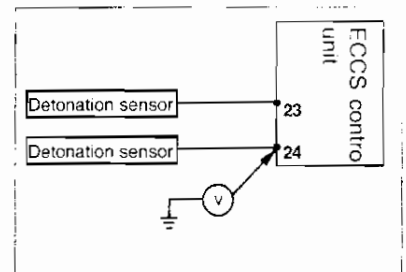

**Caution:**

The detonation sensor input signal must be measured by using oscilloscope as its resistance is greater than the circuit tester resistance. The signal should also be checked with self-diagnosis and harness continuity inspection.

**(3) Harness continuity inspection**

- Disconnect ECCS control unit and detonation sensor middle connector and measure the resistance between the following terminals.

Between ECCS C/U terminal 23 and detonation sensor middle harness terminal 2	0 Ω
Between ECCS C/U terminal 24 and detonation sensor middle harness terminal 1	

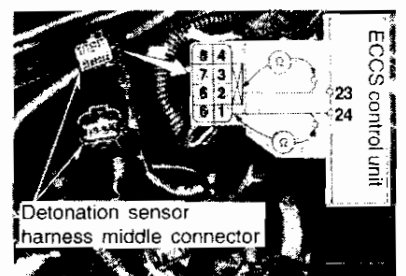

**6-8 DETONATION SENSOR SYSTEM INSPECTION  
CONTROL CIRCUIT DIAGRAM RB20E / DE / DET ENGINE**

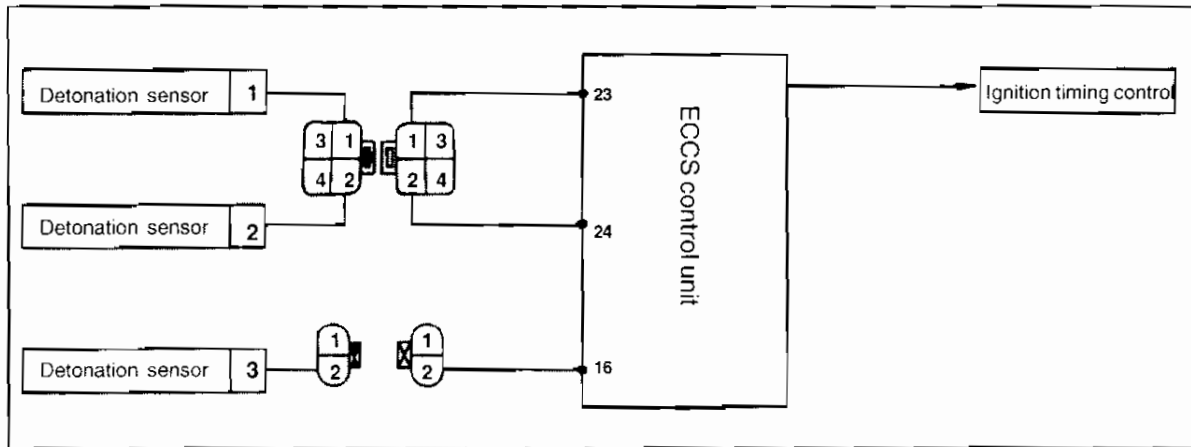

**(1) Self-diagnosis**

- There is a disconnection or short-circuit in the signal system when “CODE 34” in normal self-diagnosis or “FAILURE DETECTED DETONATION SENSOR” (when CONSULT is used) is displayed. If the problem reoccurs, use real-time diagnosis mode (CONSULT DATA MONITOR mode) or an oscilloscope to check for instantaneous break in the signal.

**(2) Input signal inspection**

- Measure the voltage between the following terminals with ECCS control unit harness connected.

Engine Condition	RB20E, DET		
	Between ECCS C/U terminal 4 and ground	Between ECCS C/U terminal 23 and ground	Between ECCS C/U terminal 24 and ground
Ignition switch is ON	Approx. 4V	Approx. 4V	Approx. 4V
Cranking	Approx. 4V	Approx. 4V	Approx. 4V
Idling	Approx. 4V	Approx. 4V	Approx. 4V

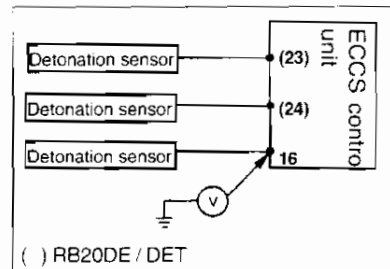

**Caution:**

The detonation sensor input signal must be measured by using oscilloscope as its resistance is greater than the circuit tester resistance. The signal should also be checked with self-diagnosis and harness continuity inspection.

**(3) Harness continuity inspection**

- Disconnect ECCS control unit and detonation sensor middle connector and measure the resistance between the following terminals.

RB20E	Between ECCS C/U terminal 16 and detonation sensor middle harness terminal 2	0 Ω
RB20DE / DET	Between ECCS C/U terminal 23, 24 and detonation sensor middle harness terminal 1, 2	

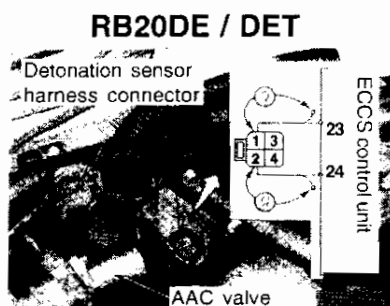
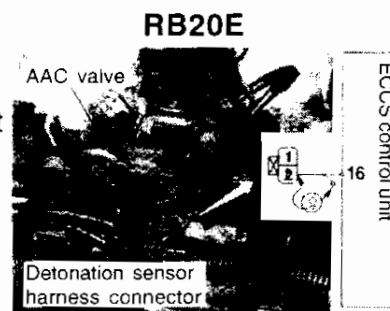

**6-9 VEHICLE SPEED SENSOR SYSTEM INSPECTION  
CONTROL CIRCUIT DIAGRAM**

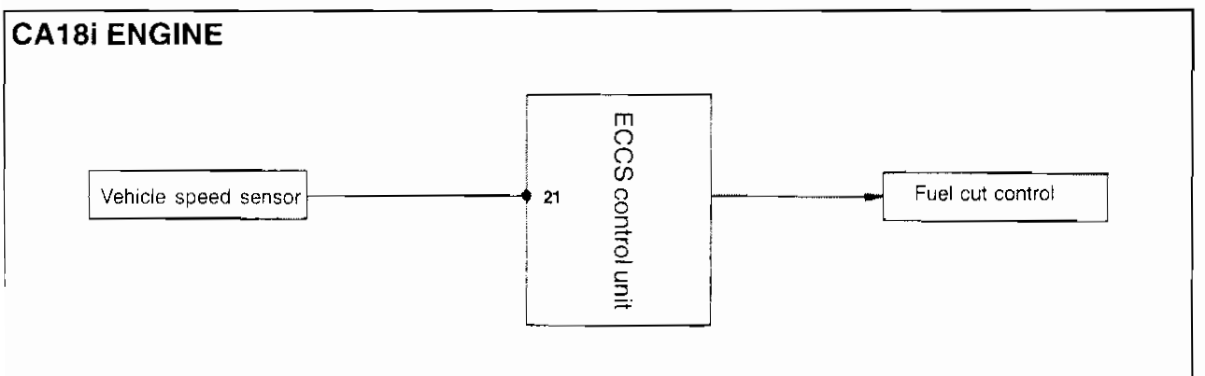
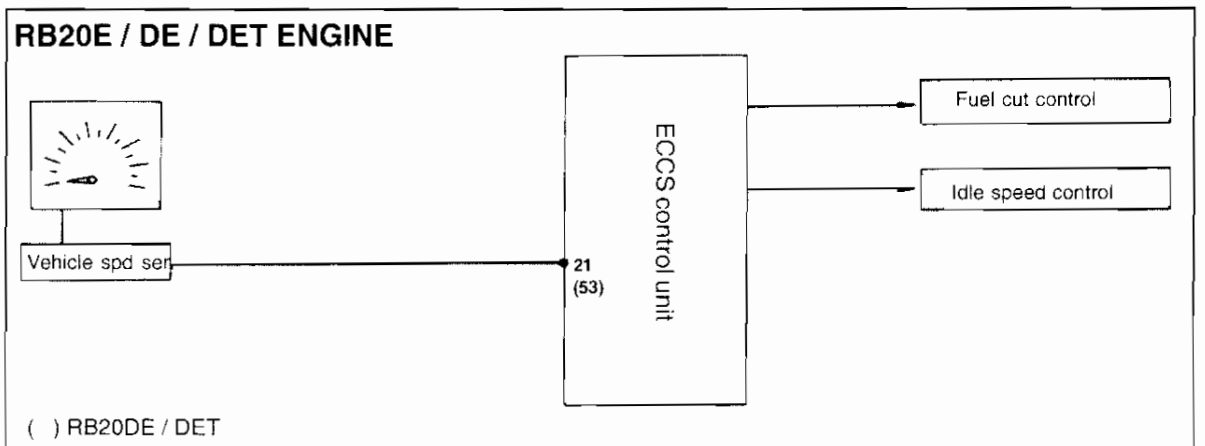
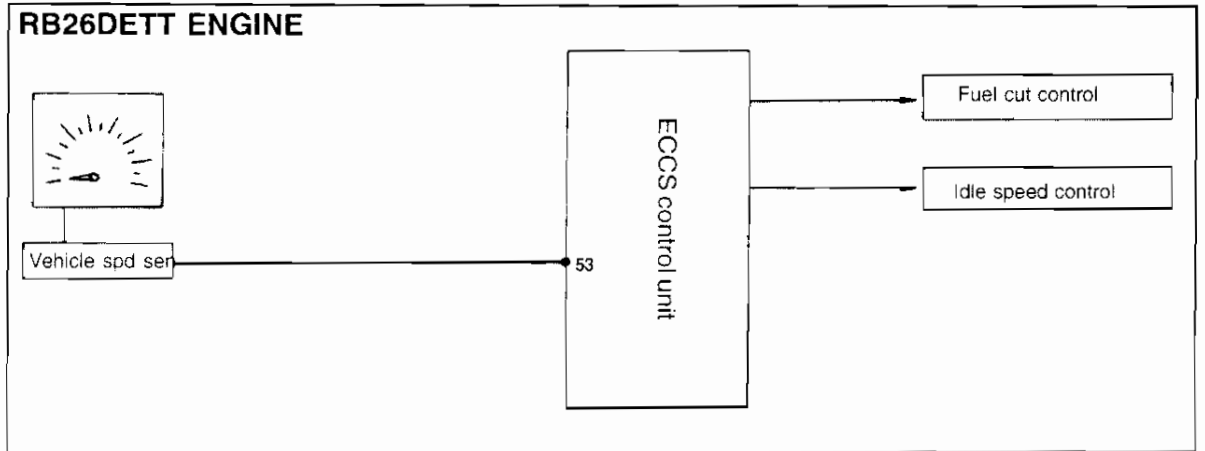

## SENSOR SYSTEM INSPECTION

RB26DETT / RB20E / DE / DET / CA18i ENGINE

### (1) Input signal inspection

- Select "VEHICLE SPEED SENSOR" in "DATA MONITOR" mode and check the following items. 

Condition	Vehicle speed sensor
When drive wheels are rotating	Vehicle speed is displayed

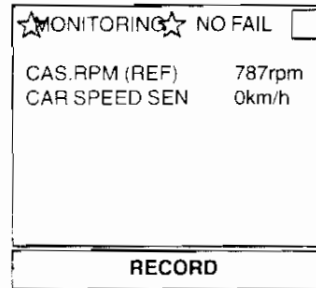

- Measure the voltage between the following terminals with ECCS control unit connectors connected. 

Engine	RB26DETT / RB20DE / DET	RB20E / CA18i
Measurement location	Between ECCS C/U terminal 45 and ground	Between ECCS C/U terminal 21 and ground
When drive wheels are rotating slowly	Deflection between 0V and 5V (also appears as deflection around 1V)	

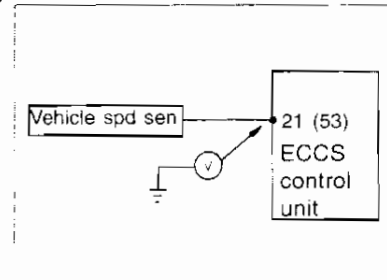

## 6-10 IGNITION SWITCH (START SWITCH) SIGNAL INSPECTION

### (1) Input signal inspection

- In "DATA MONITOR" mode, perform the key operation to check if the ignition switch "START" signal is input correctly. 

- Measure the voltage between the following terminals with ECCS control unit harness connected. 

Engine	RB26DETT / RB20DE / DET	RB20E	CA18i
Measurement location	ECCS C/U terminal 45 and ground	ECCS C/U terminal 25 and ground	ECCS C/U terminal 23 and ground
Other than ignition switch at "START"	0V		
Ignition switch at "START"	Battery voltage		

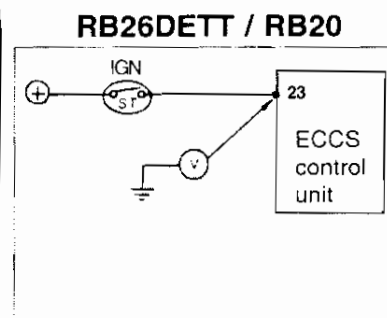
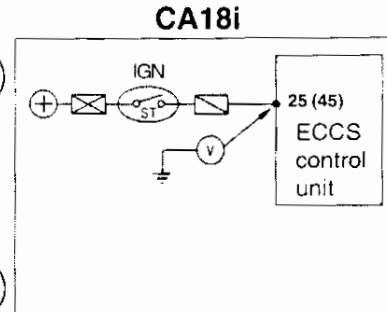



6-11 AIR CONDITIONER SIGNAL INSPECTION

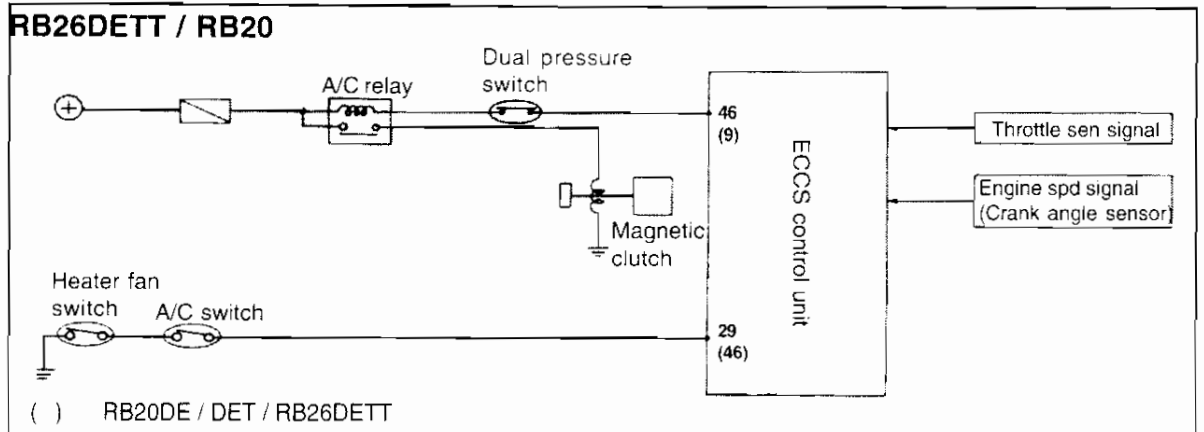

(1) Input signal inspection

- In "DATA MONITOR" mode, perform the air conditioner switch operation to check if the air conditioner switch signal is input correctly.
- Measure the voltage between the following terminals with ECCS control unit harness connected.



CA18i

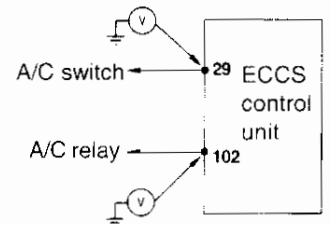

Engine	RB20E / DE / DET	RB26DETT		CA18i
Measurement location	ECCS C/U terminal 46 (9) and ground	ECCS C/U terminal 9 and ground	ECCS C/U terminal 46 and ground	ECCS C/U terminal 102, 29 and ground
A/C ON	0V	Battery voltage	8 ~ 9 V	Battery voltage
A/C OFF	Battery voltage	0 ~ 1V	Battery voltage	0V

6 - 12 NEUTRAL SWITCH SIGNAL INSPECTION

(1) Input signal inspection

- In "DATA MONITOR" mode, perform shift lever operation to check if neutral switch signal is input correctly.
- Measure the voltage between the following terminals and ground with ECCS control unit harness connected.



Engine		RB20E	RB26DETT / RB20DE / DET	CA18i
Measurement location		ECCS C/U terminal 24 and ground	ECCS C/U terminal 44 and ground	ECCS C/U terminal 24 and ground
Ignition switch ON	Not NP position	4 ~ 5V	4 ~ 5V	6 ~ 7V
	NP position	Approx. 0V	Approx. 0V	Approx. 0V

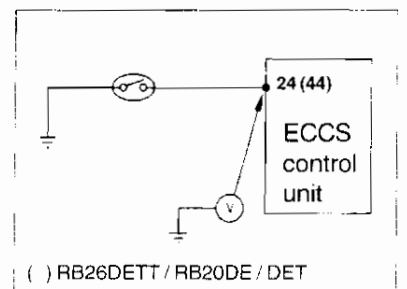

**6-13 POWER STEERING SWITCH SIGNAL INSPECTION**

**(1) Input signal inspection**

- In "DATA MONITOR" mode, perform power steering operation to check if power steering oil pressure switch signal is input correctly.
- Measure the voltage between the following terminals with ECCS control unit harness connected.

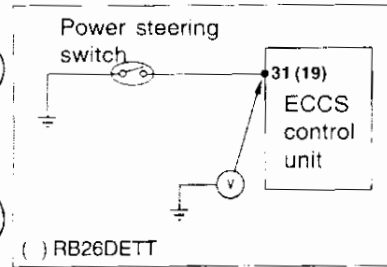

Engine		CA18i	RB26DETT
<b>Measurement location</b>		ECCS C/U terminal 31 and ground	ECCS C/U terminal 19 and ground
<b>Idling</b>	<b>Power steering OFF</b>	Approx. 8V	Approx. 5V
	<b>Power steering ON</b>	Approx. 0V	Approx. 0V

**CA18i**

**6-14 LIGHT SWITCH SIGNAL INSPECTION**

**(1) input signal inspection**

- In "DATA MONITOR" mode, perform light switch operation to check if light switch signal is input correctly.
- Measure the voltage between the following terminals with ECCS control unit harness connected.

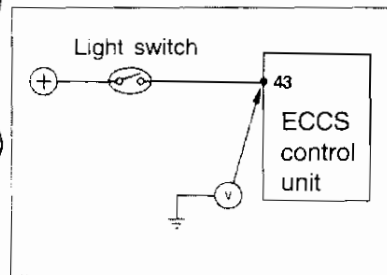

Engine		CA18i
<b>Ignition switch ON</b>	Head lamp OFF	Approx. 0V
	Head lamp ON	Power voltage

**6-15 HEATER FAN SIGNAL INSPECTION**

**(1) Input signal inspection**

- In "DATA MONITOR" mode, perform heater fan operation to check if heater fan switch signal is input correctly.
- Measure the voltage between the following terminals with ECCS control unit harness connected.

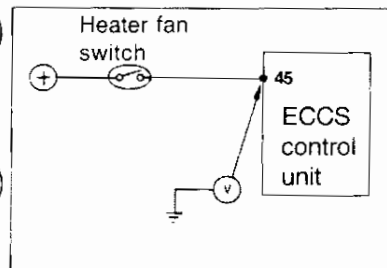

Engine		CA18i
<b>Ignition switch ON</b>	Heater fan OFF	Approx. 0V
	Heater fan ON	Power voltage

DIAGNOSIS 1 - POWER SUPPLY & GROUND CIRCUIT

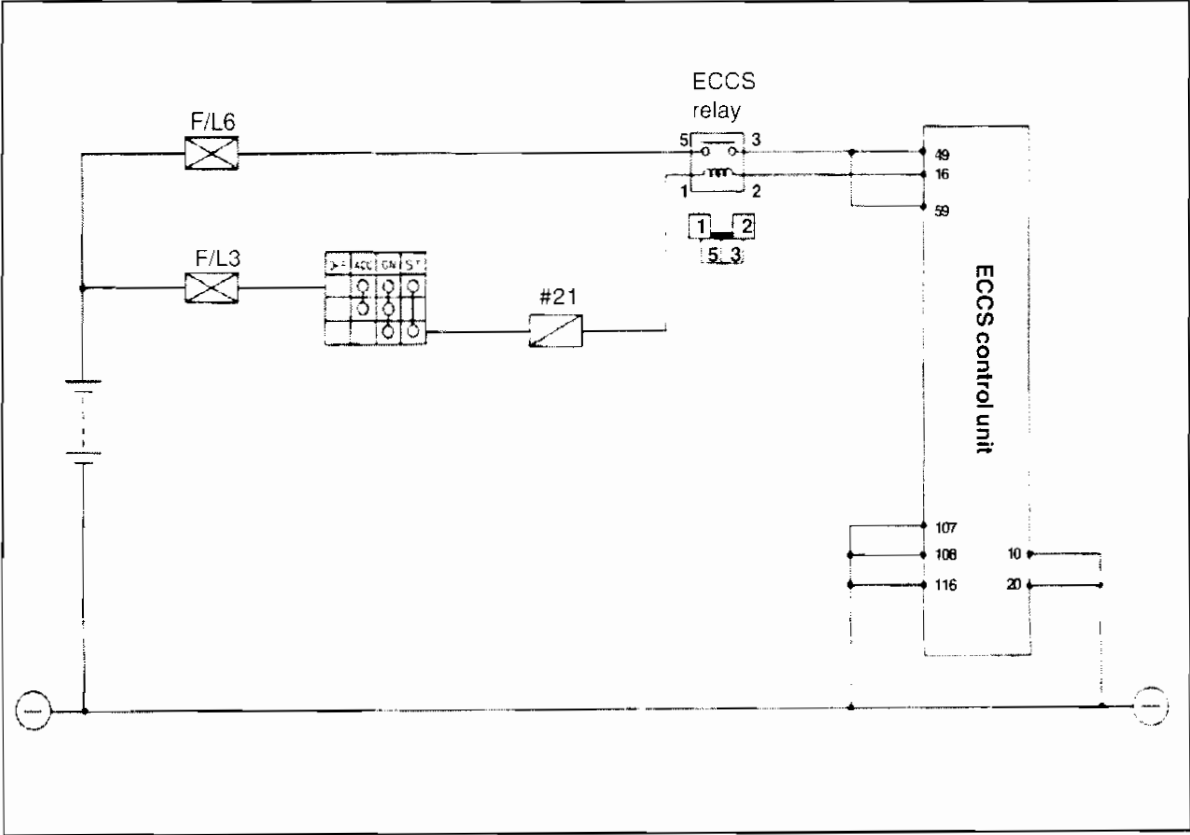

Components location

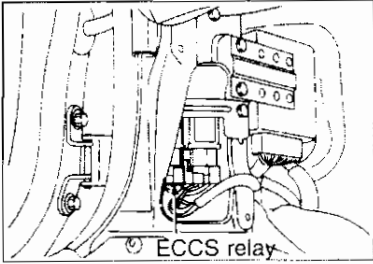
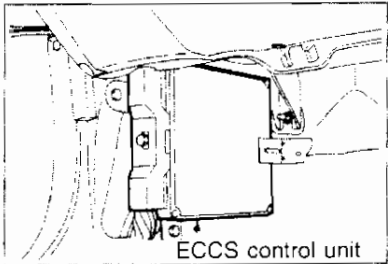

RB25DE ENGINE

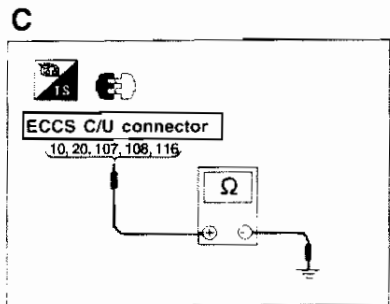
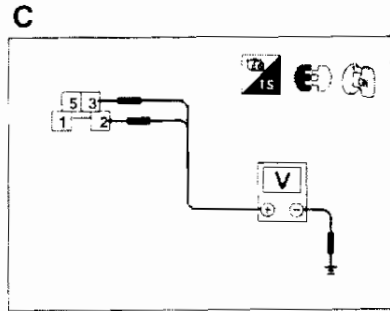
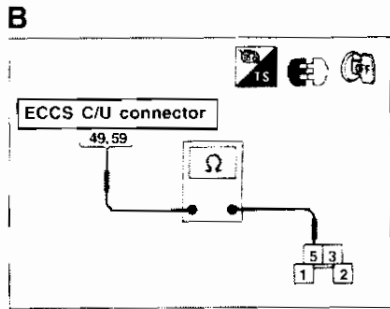
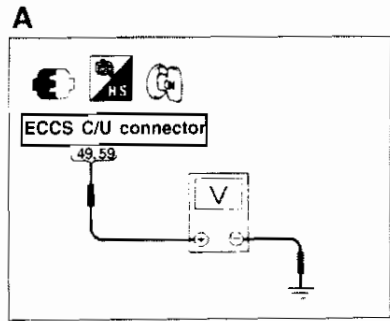
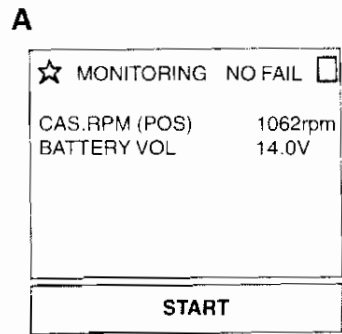
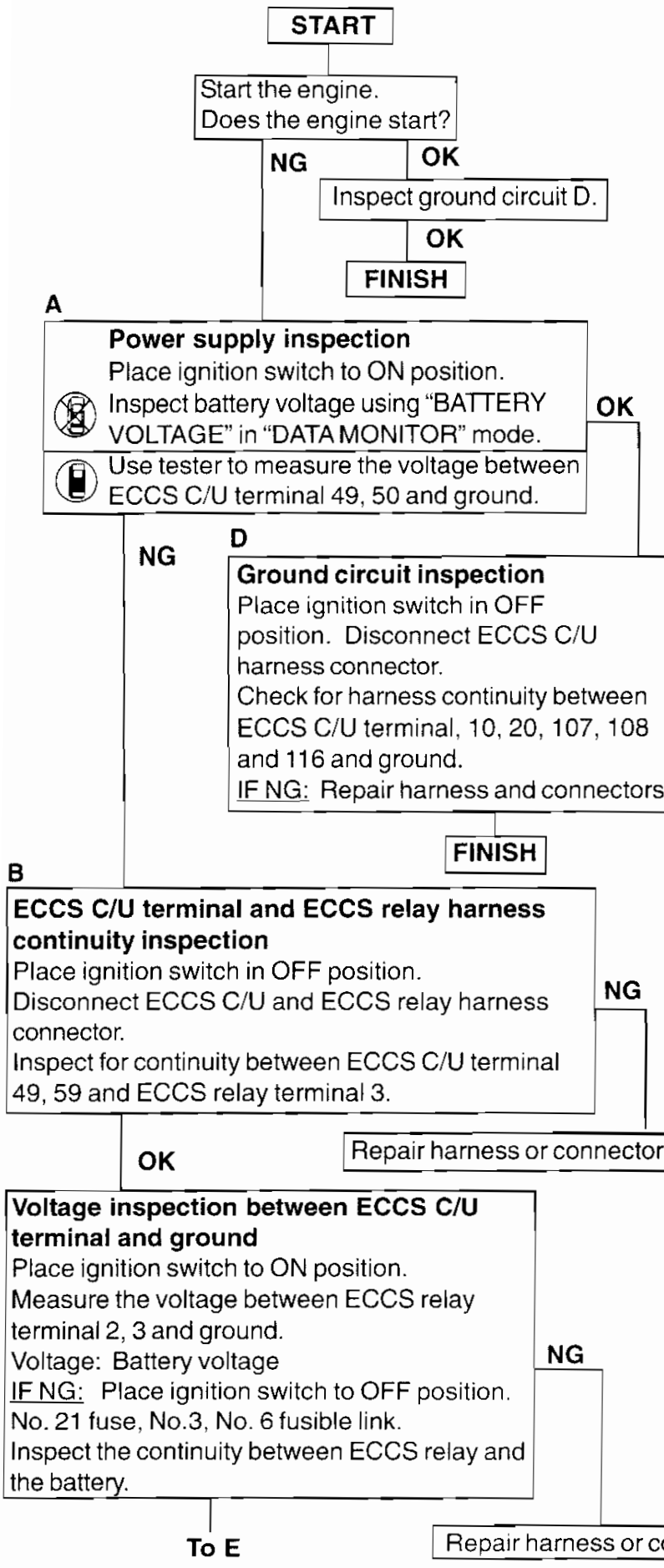

RB25DE ENGINE

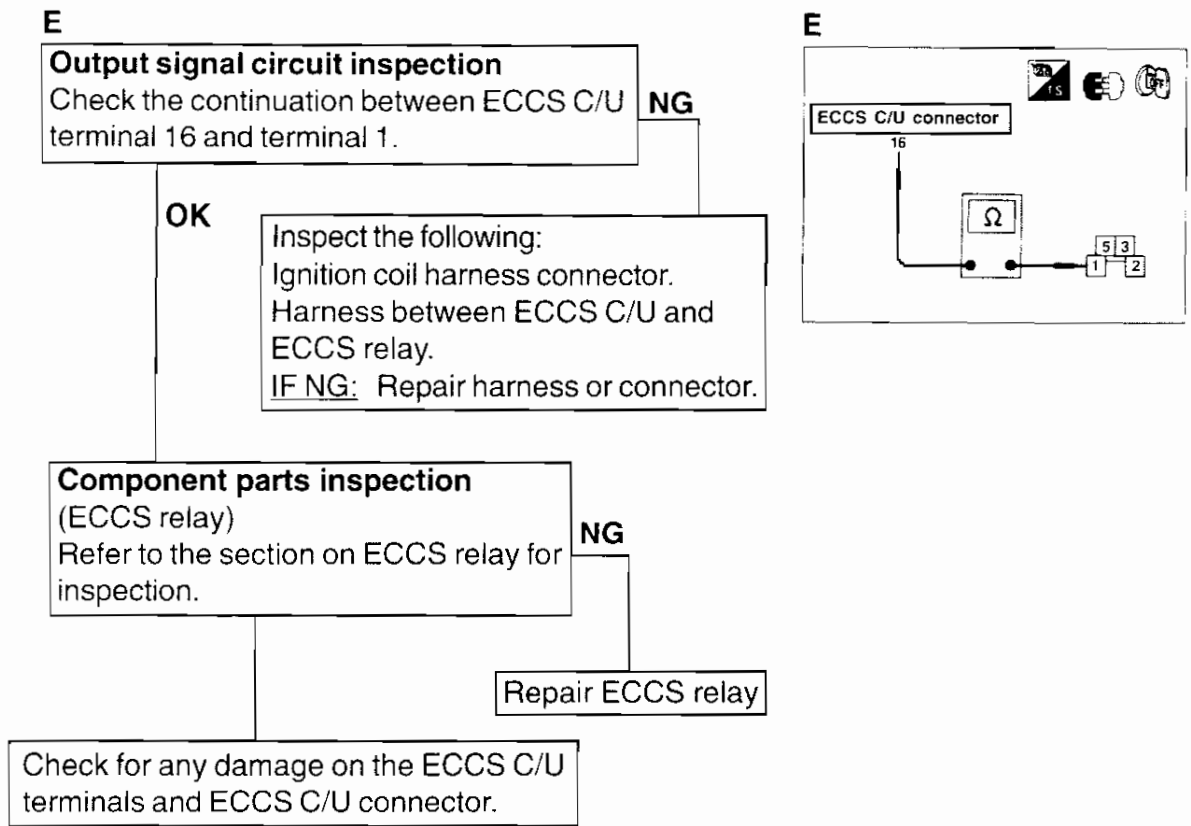

Carry out the inspection in the following order after repairs.

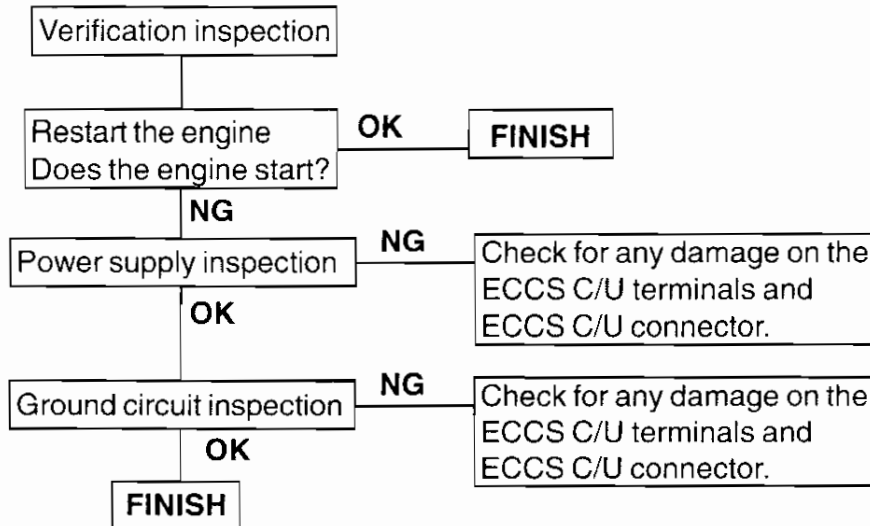

**DIAGNOSIS 2 - CRANK ANGLE SENSOR (CODE NO. 11 IN SELF-DIAGNOSIS)**

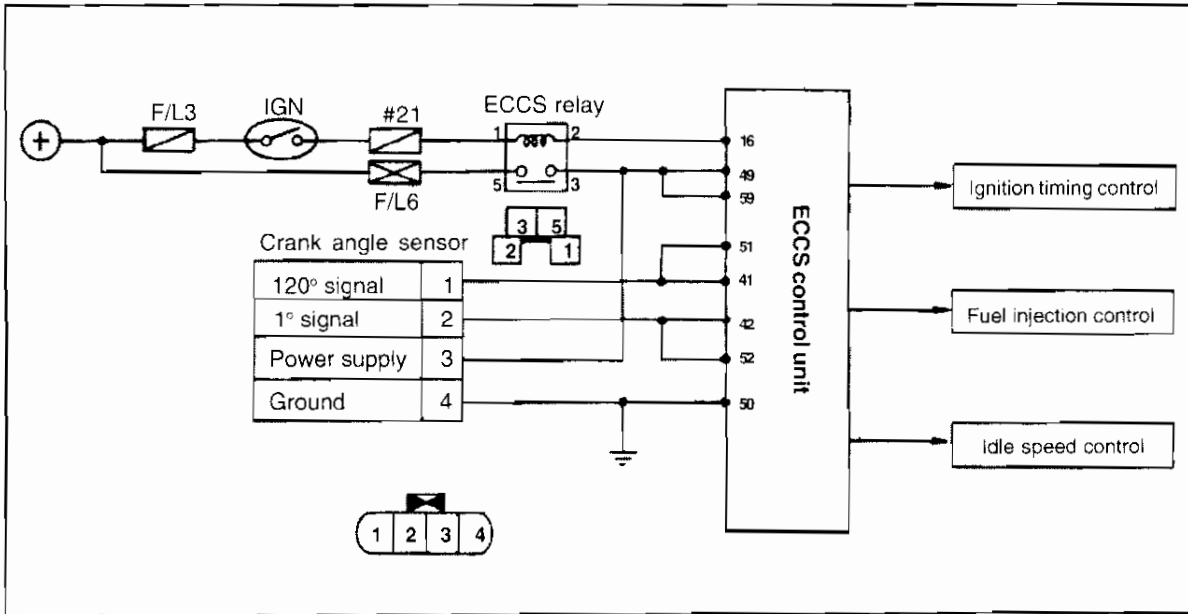

**Components location**

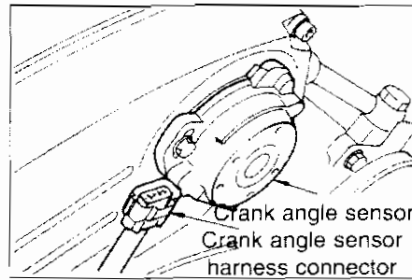
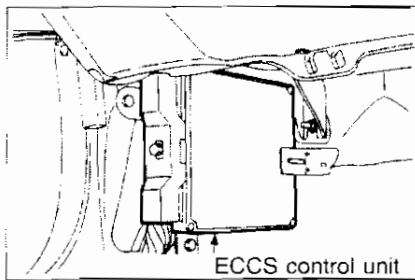

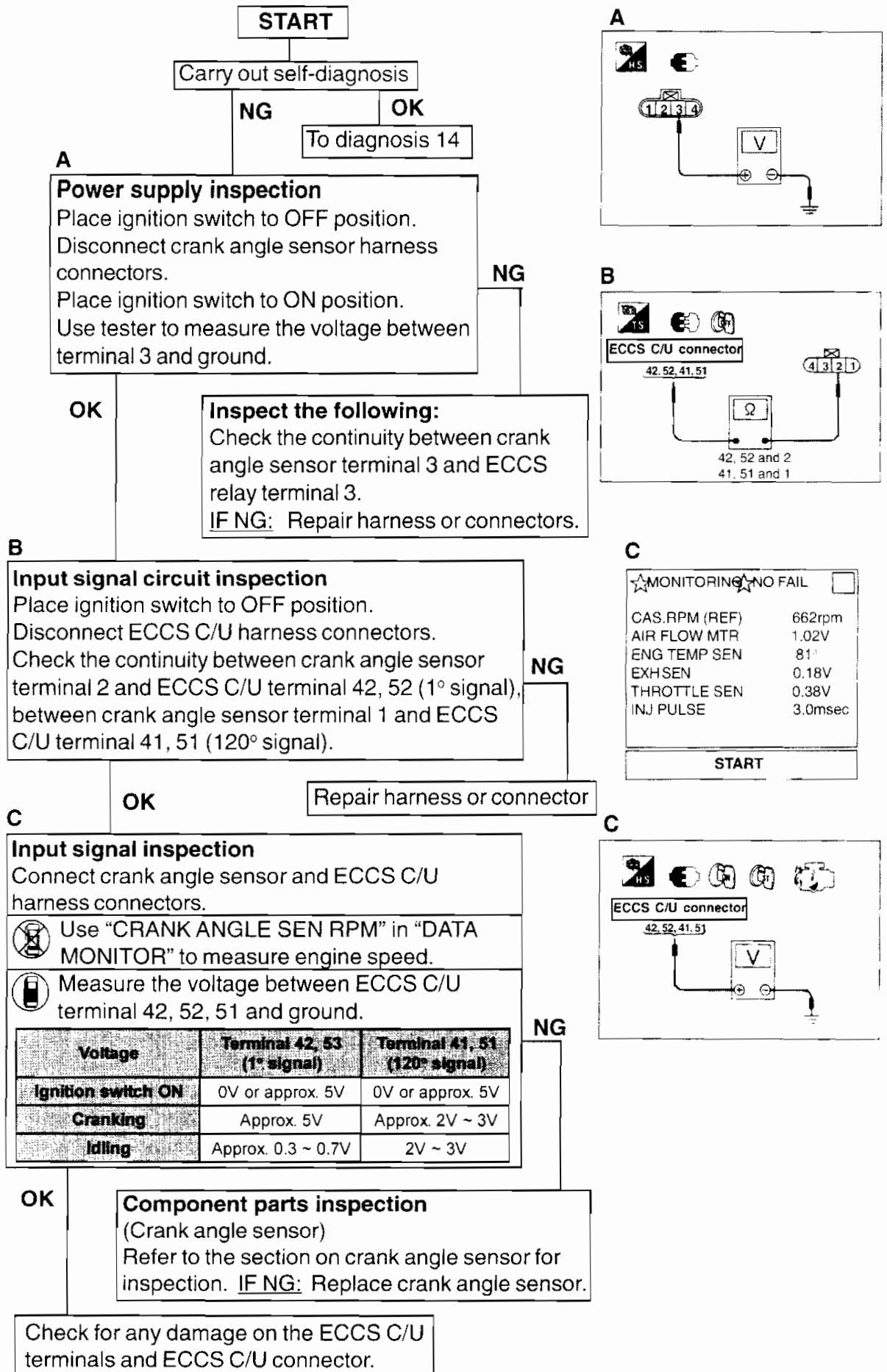

Carry out the inspection in the following order after repairs.

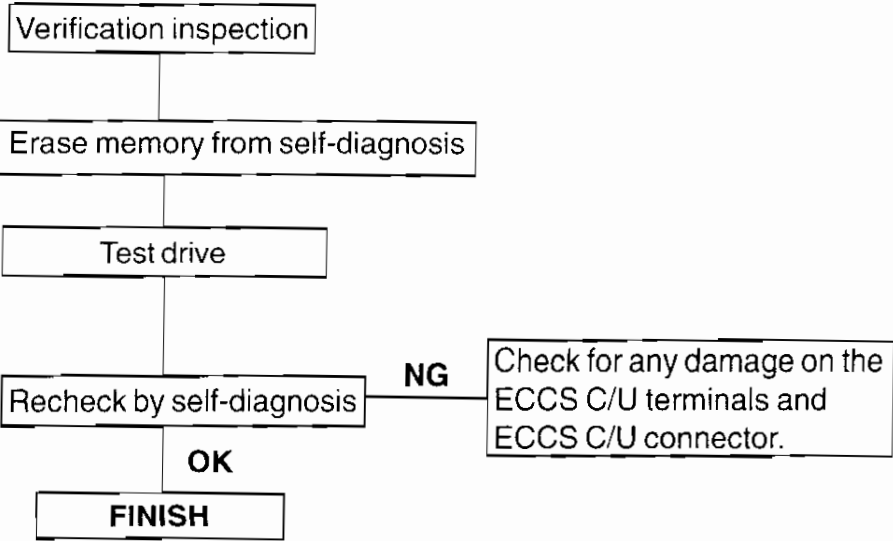



**DIAGNOSIS 3 - AIR FLOW METER (CODE NO. 12 IN SELF-DIAGNOSIS)**

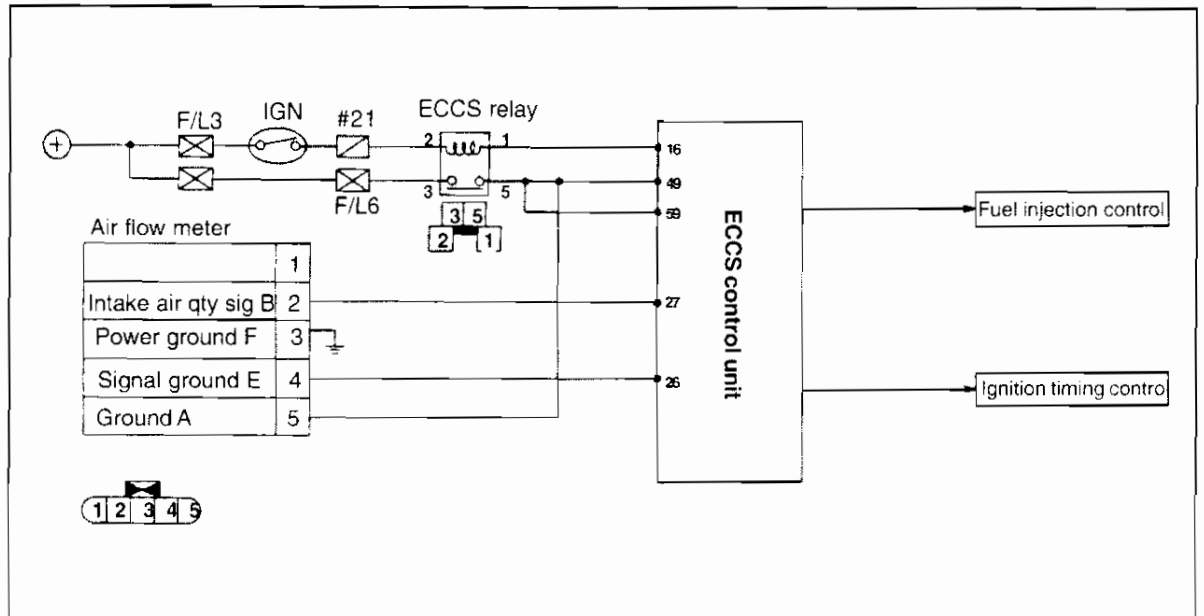

**Components location**

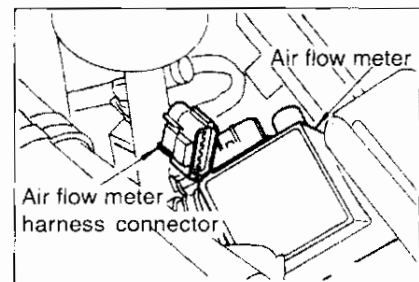
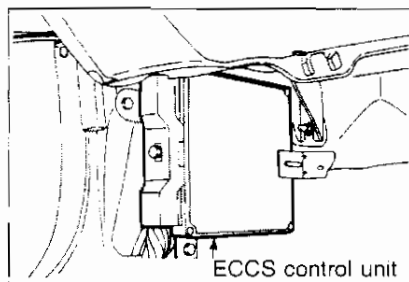

RB25DE ENGINE

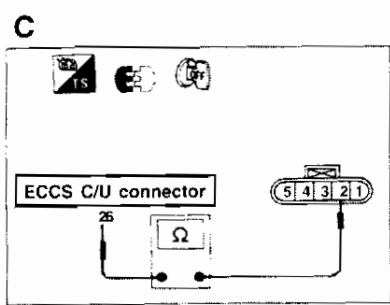
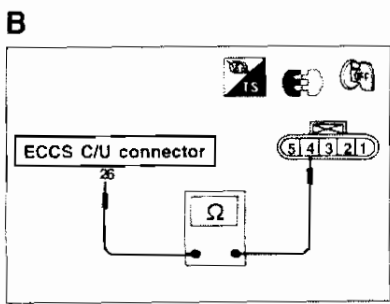
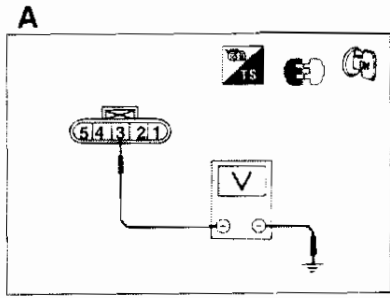
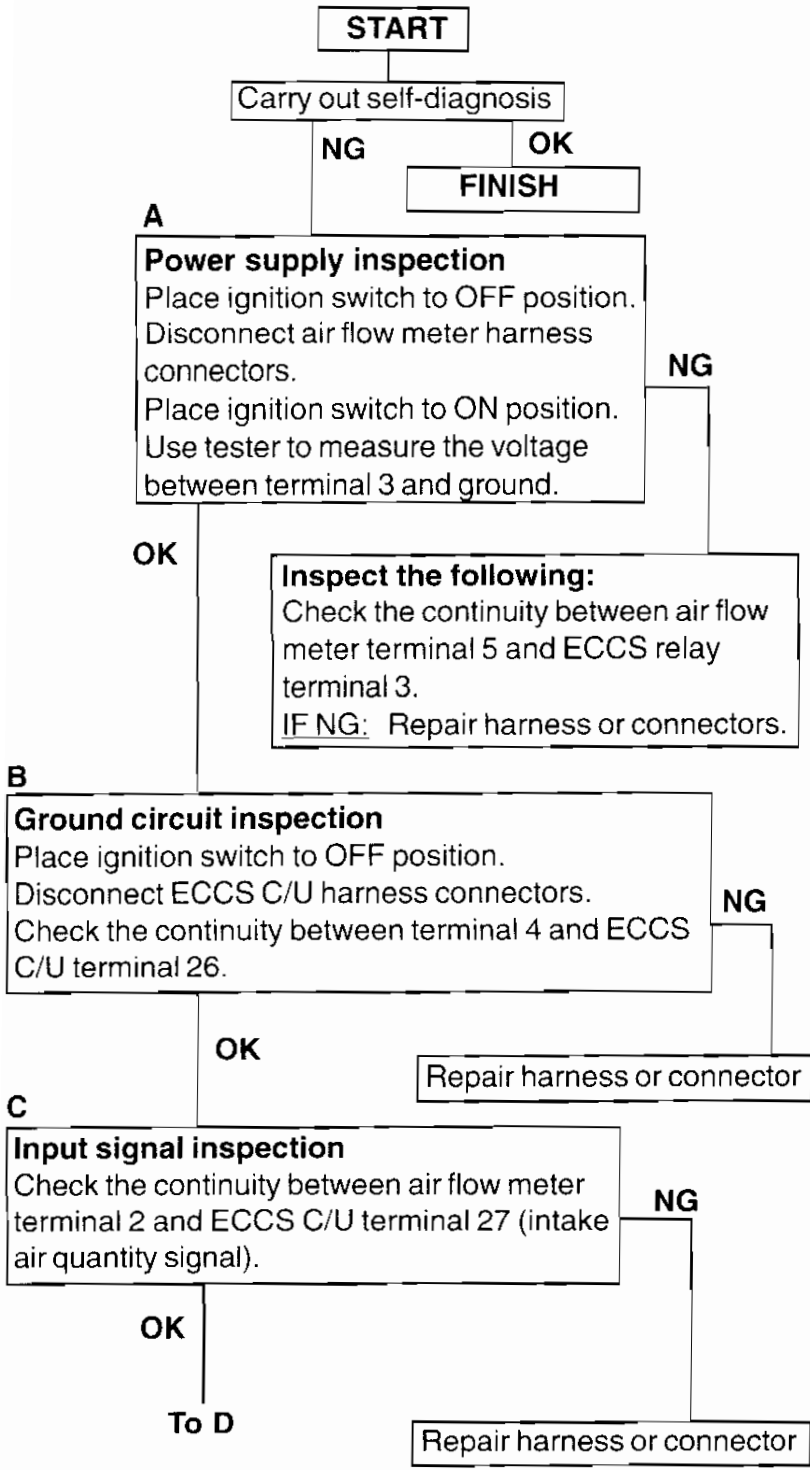

D

**Input signal inspection**  
Connect crank air flow meter and ECCS C/U harness connectors.

Use "AIR FLOW METER" in "DATA MONITOR" to measure input signal.

Measure the voltage between ECCS C/U terminal 27 and ground.

Voltage	Terminal 27 (Intake air quantity signal)
Ignition switch ON	Approx. 0.3V
Cranking	Approx. 1V
Idling	Approx. 1.1V

NG

OK

**Component parts inspection**  
(Crank angle sensor)  
Refer to the section on crank angle sensor for inspection. IF NG: Replace crank angle sensor.

Check for any damage on the ECCS C/U terminals and ECCS C/U connector.

D

☆ MONITORING ☆ NO FAIL

CAS.RPM (REF)	662rpm
AIR FLOW MTR	1.02V
ENG TEMP SEN	81°
EXH SEN	0.18V
THROTTLE SEN	0.40V
INJ PULSE	3.0msec

START

D

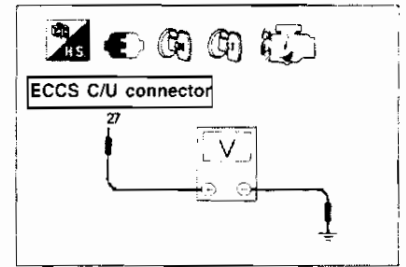

Carry out the inspection in the following order after repairs.

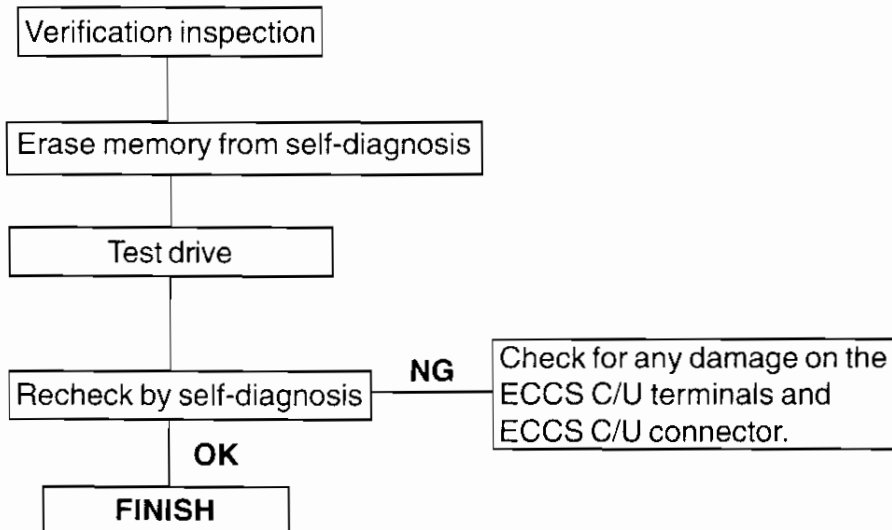

**DIAGNOSIS 4 - ENGINE TEMPERATURE SENSOR  
(CODE NO. 13 IN SELF-DIAGNOSIS)**

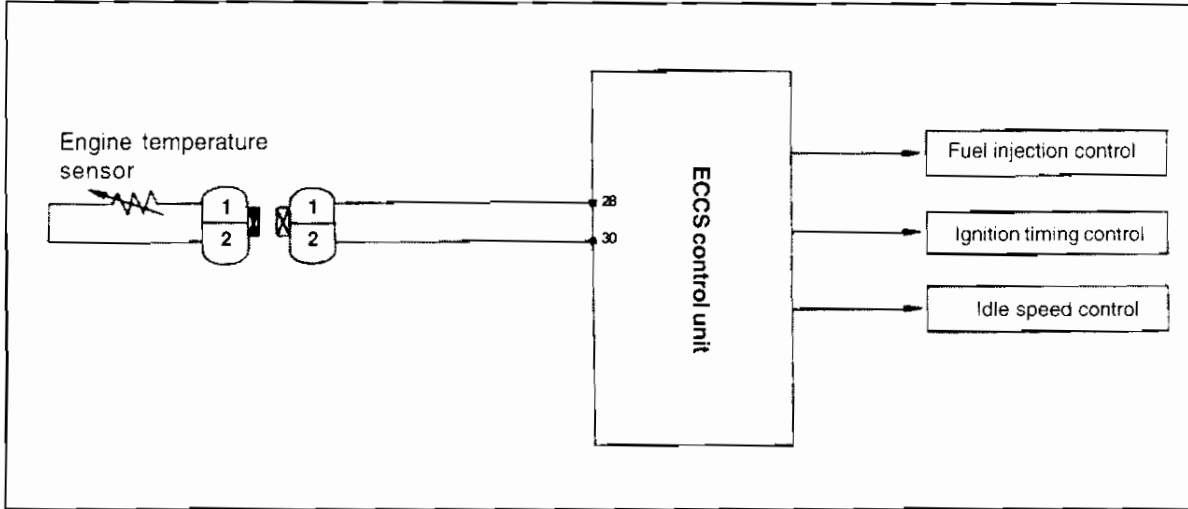

**Components location**

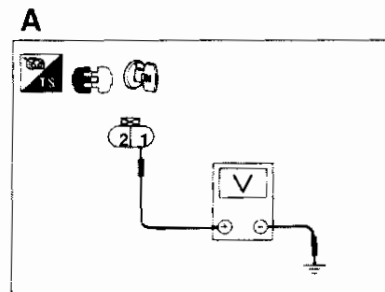
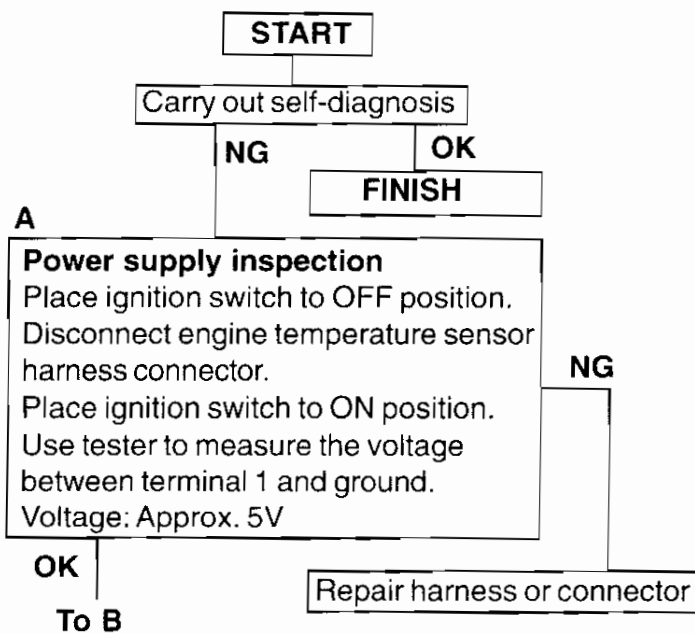
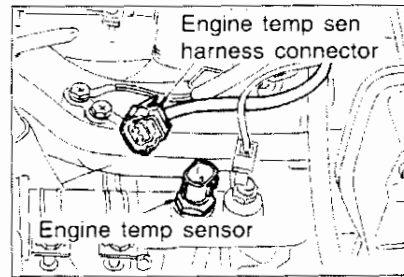
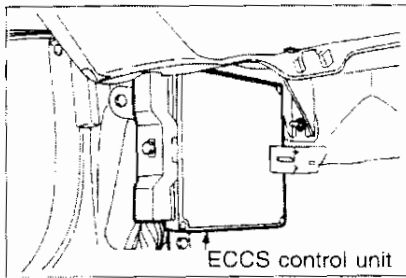

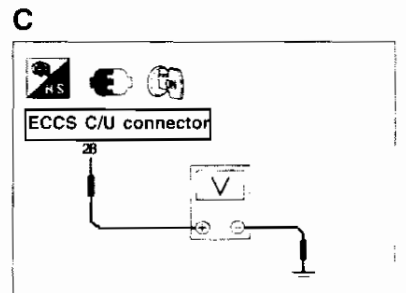
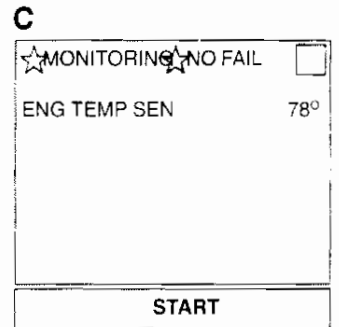
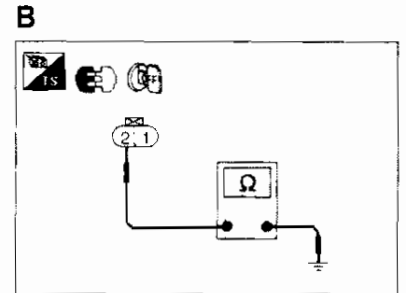
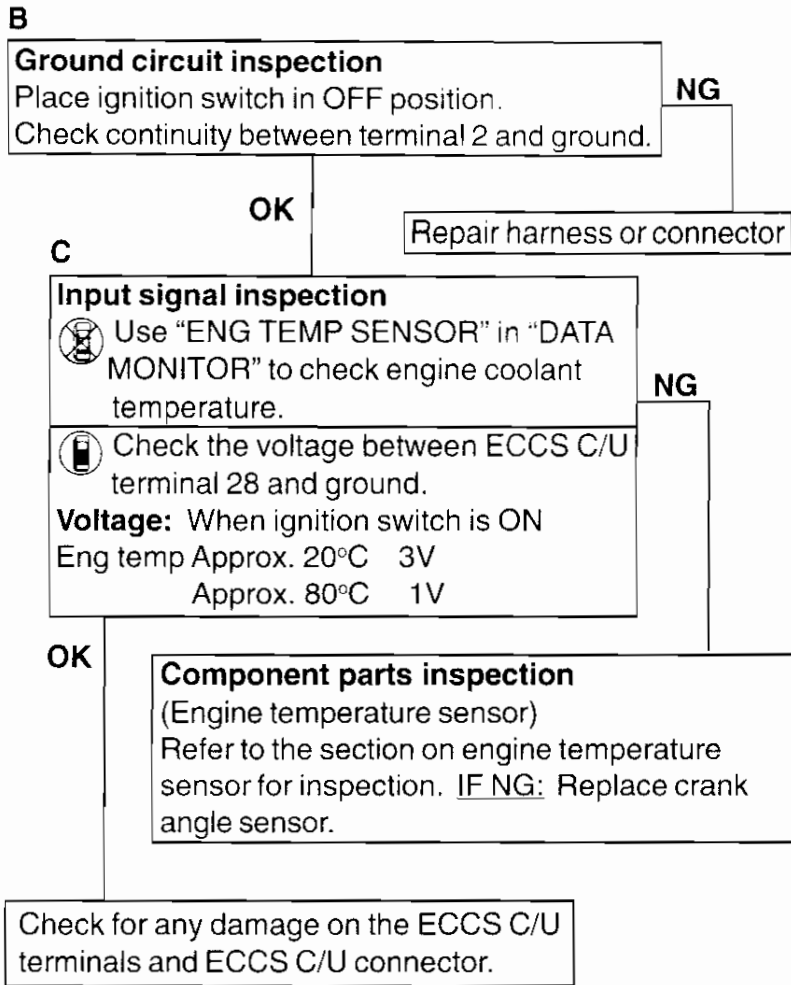

Carry out the inspection in the following order after repairs.

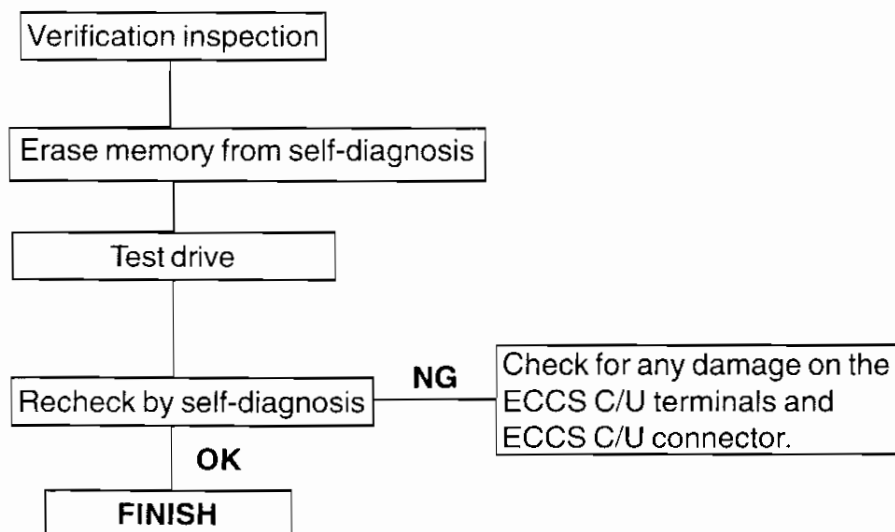

**DIAGNOSIS 5 - IGNITION SYSTEM INSPECTION  
(CODE NO. 21 IN SELF-DIAGNOSIS)**

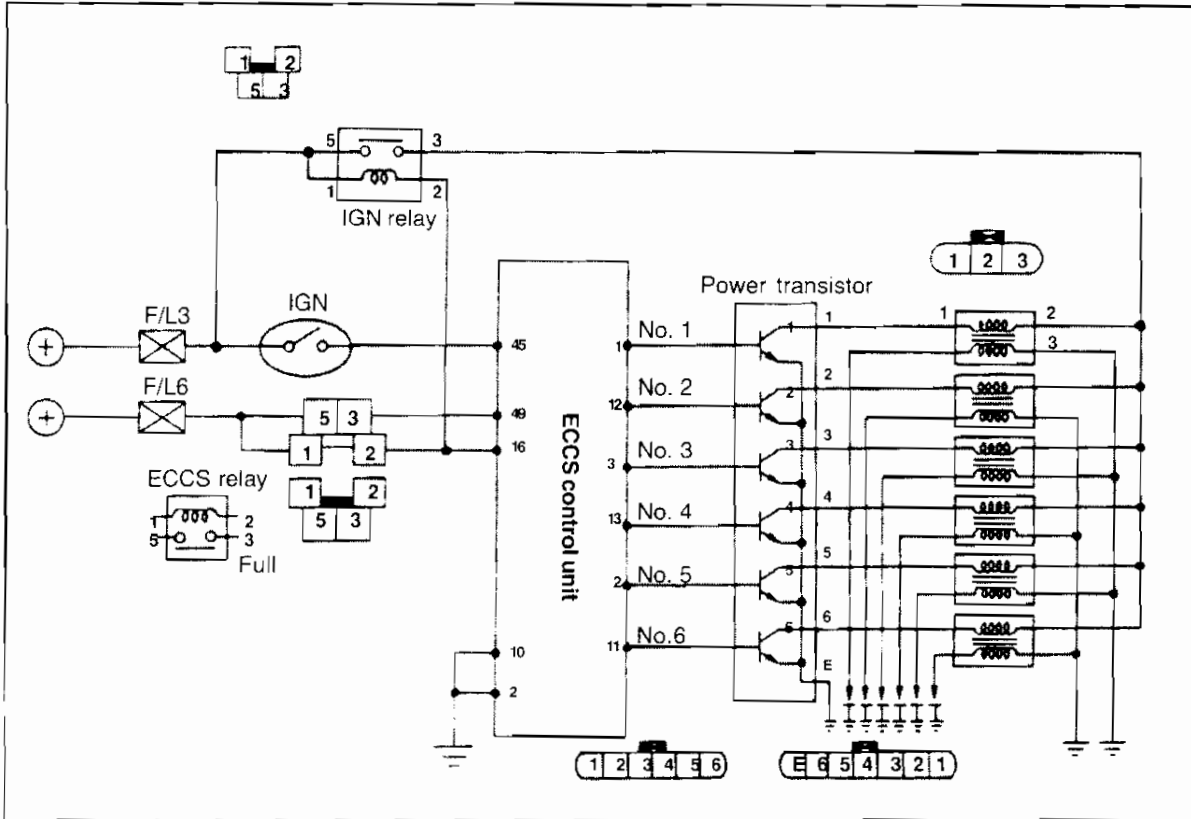

**Components location**

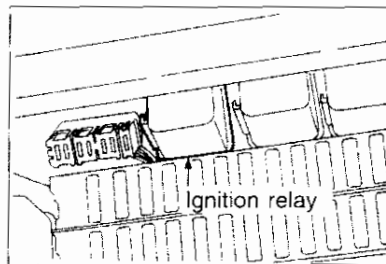
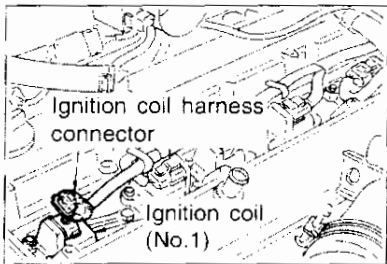
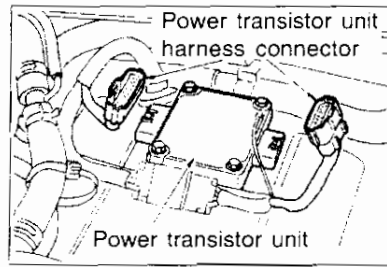
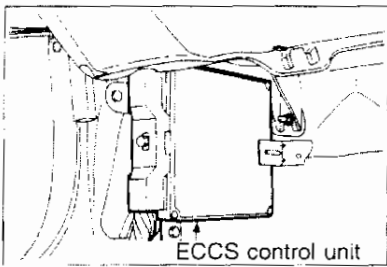

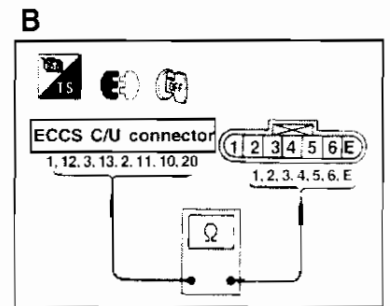
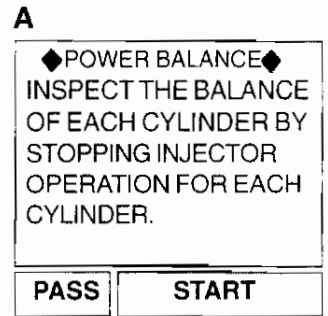
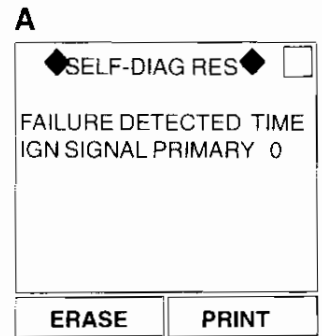
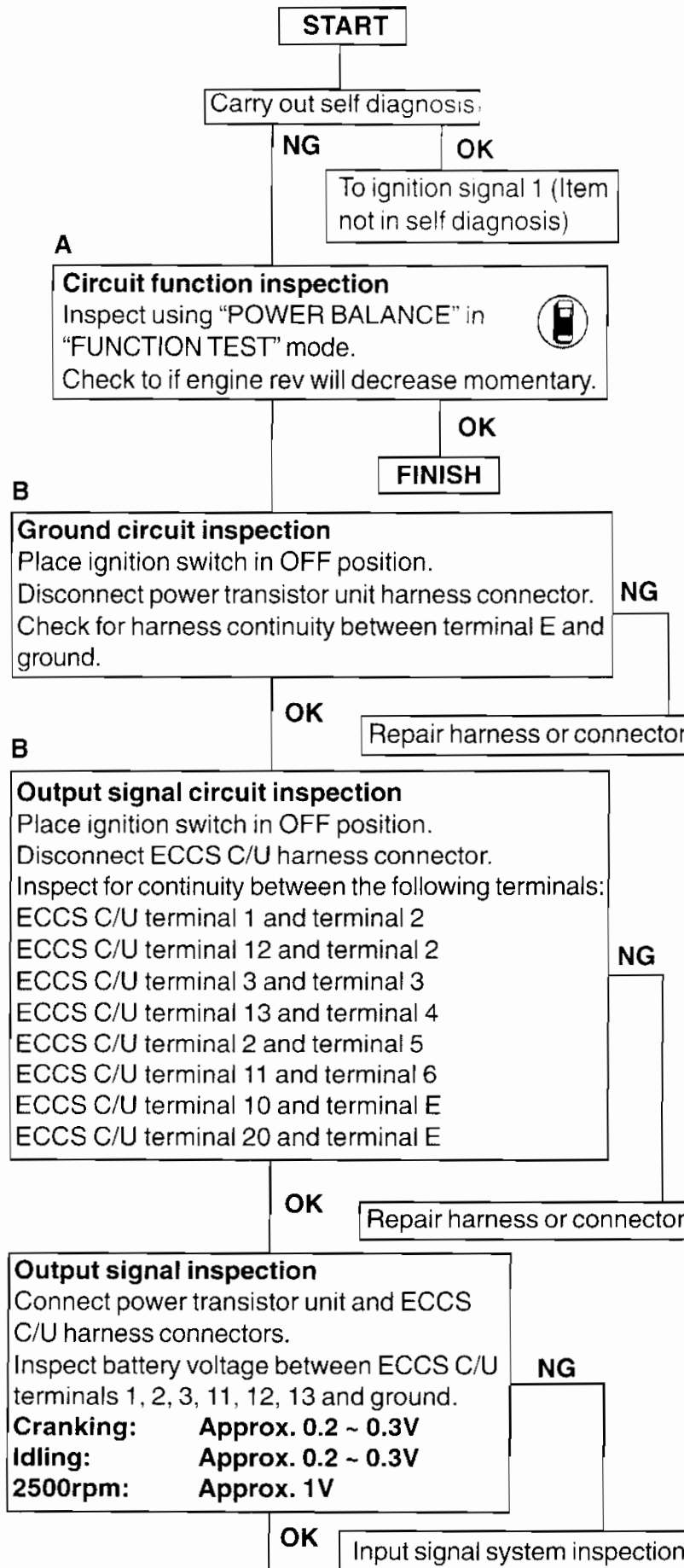

RB25DE ENGINE

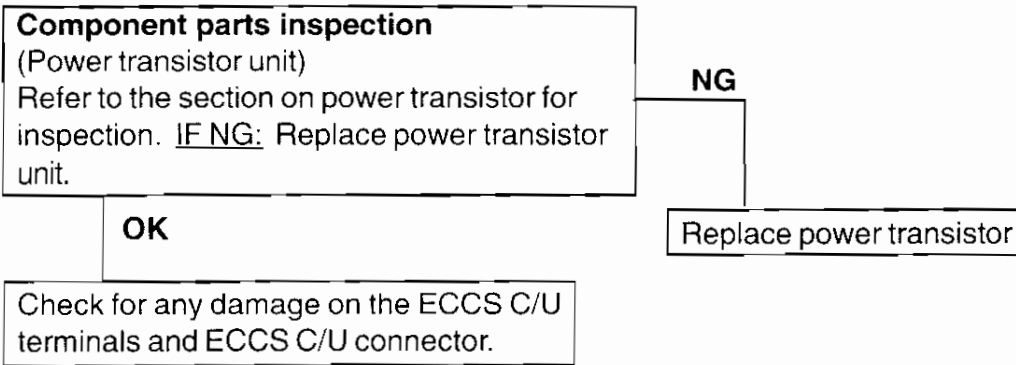

Carry out the inspection in the following order after repairs.

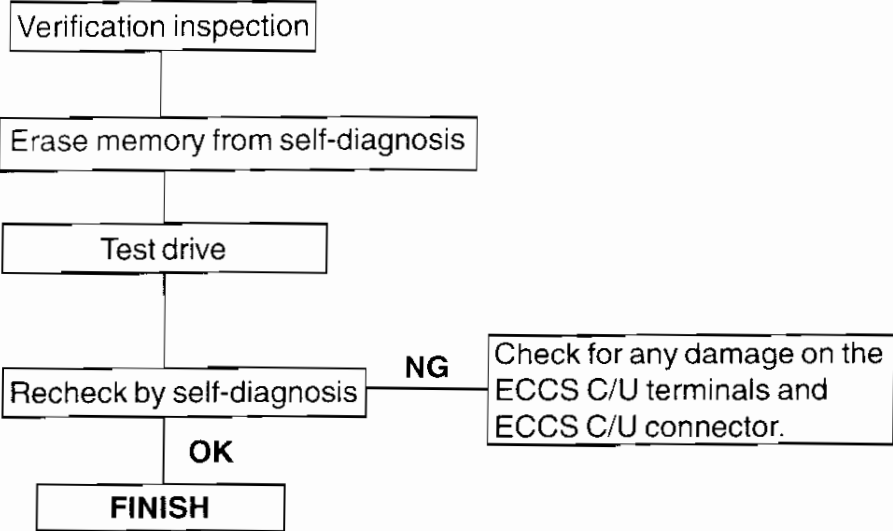



**DIAGNOSIS 6 - EXHAUST GAS SENSOR  
(CODE NO. 15 IN SELF-DIAGNOSIS)**

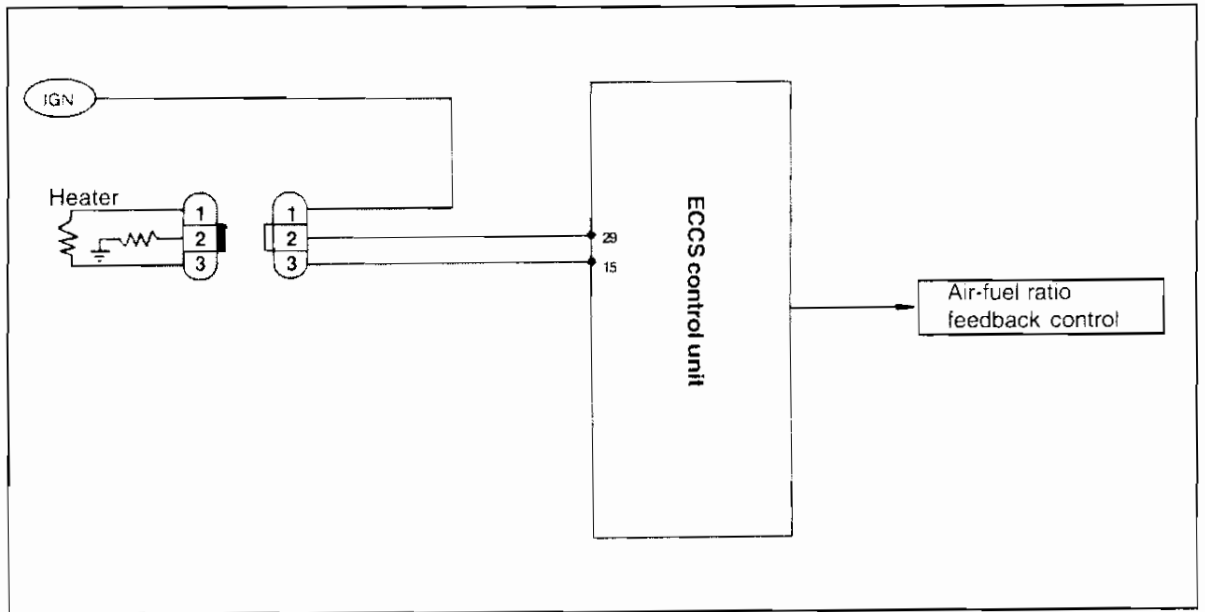

**Components location**

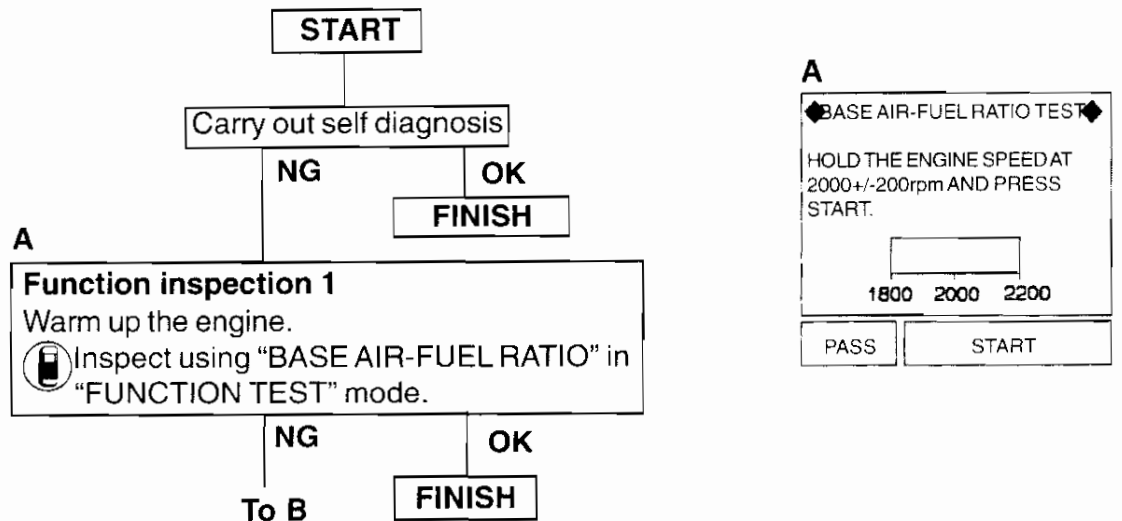
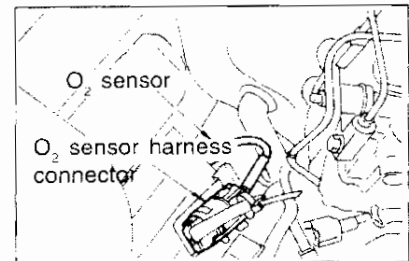
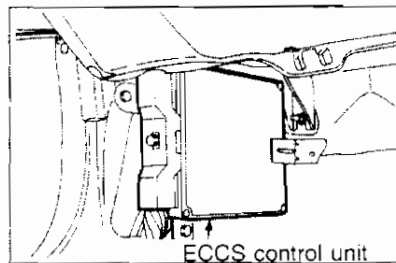

B

**Function inspection 2**  
 Start the engine.

- Hold the engine at 2000 rpm and inspect using "O<sub>2</sub> SENSOR" (output voltage and "O<sub>2</sub> SENSOR MONITOR" (lean, rich) in "DATA MONITOR" mode.
- Measure the voltage between ECCS C/U terminal 29 and ground.  
 Approx. 0.3V (constant voltage) NG  
 Approx. over 0.6 ~ 1V (variant voltage) OK

OK

FINISH

NG

B

★MONITORING★ NO FAIL

CAS.RPM (REF)	650rpm
O2 SENSOR	0.02V
O2 SENSOR MTR	RICH

START

C

**Input signal circuit inspection**  
 Place ignition switch to OFF position.  
 Disconnect O<sub>2</sub> sensor harness connector and ECCS C/U harness connector.  
 Check continuity between ECCS C/U terminal 29 and O<sub>2</sub> sensor harness connector terminal 2.

NG

Repair harness or connector

OK

Replace O<sub>2</sub> sensor

Check for any damage on the ECCS C/U terminals and ECCS C/U connector.

B

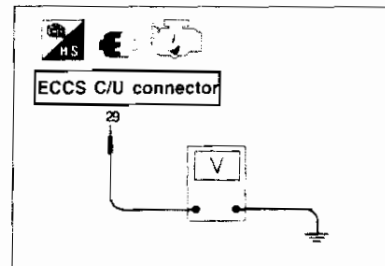

C

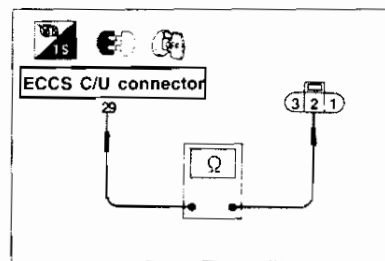

Carry out the inspection in the following order after repairs.

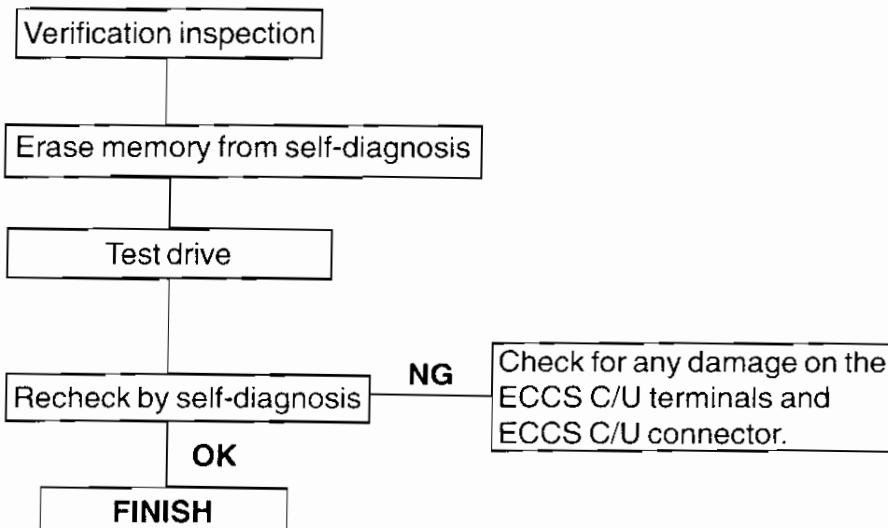

**DIAGNOSIS 7 - DETONATION SENSOR  
(CODE NO. 15 IN SELF-DIAGNOSIS)**

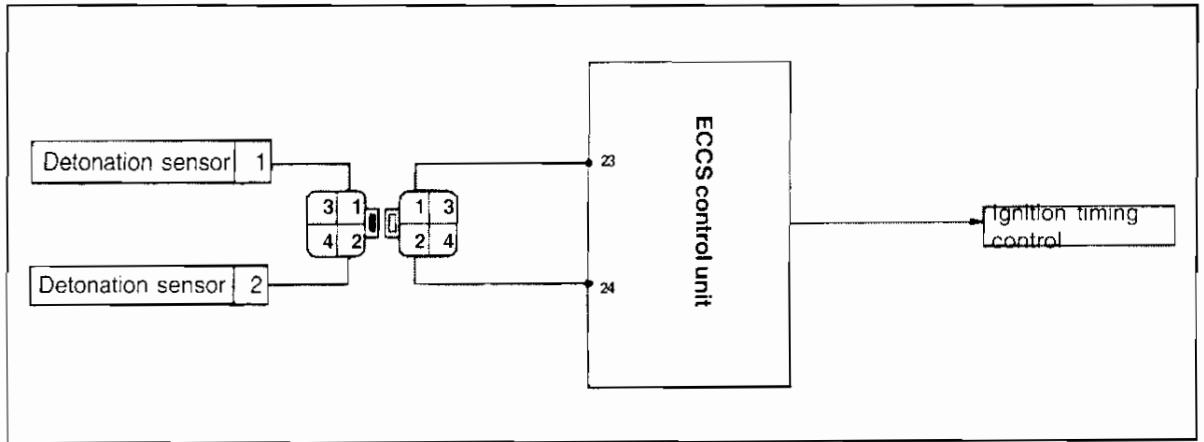

**Components location**

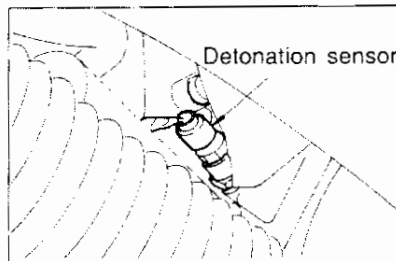
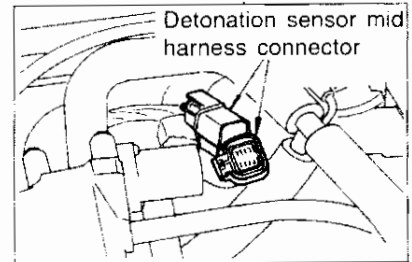
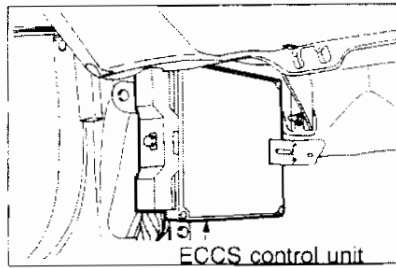

RB25DE ENGINE

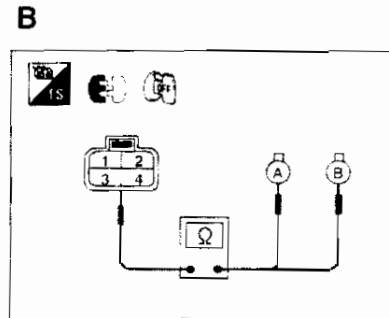
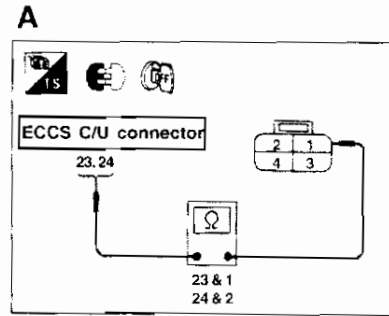
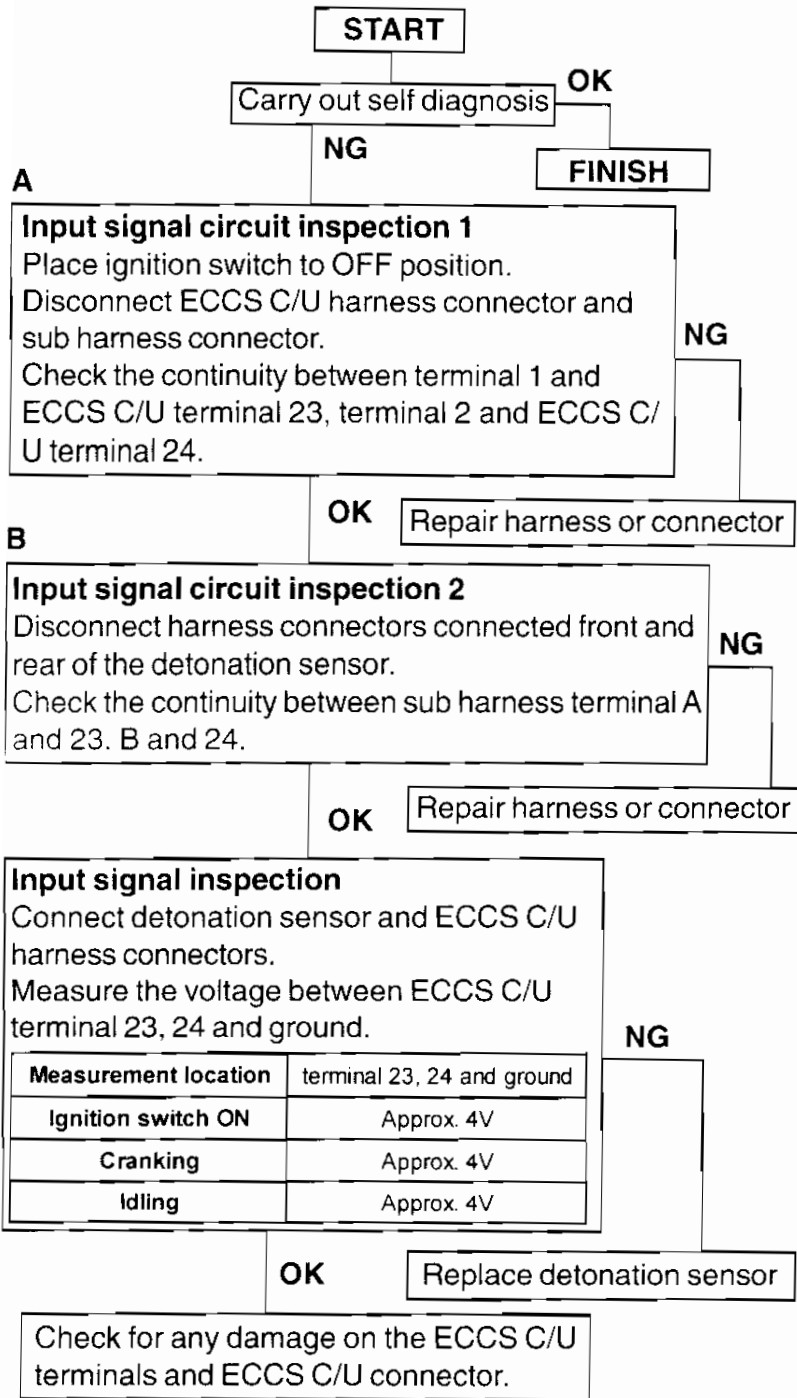

Carry out the inspection in the following order after repairs.

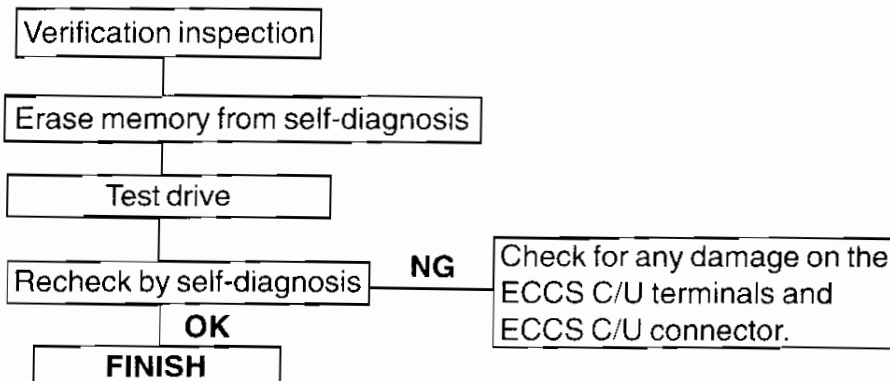

**DIAGNOSIS 8 - THROTTLE SENSOR (CODE NO. 43 IN SELF-DIAGNOSIS)**

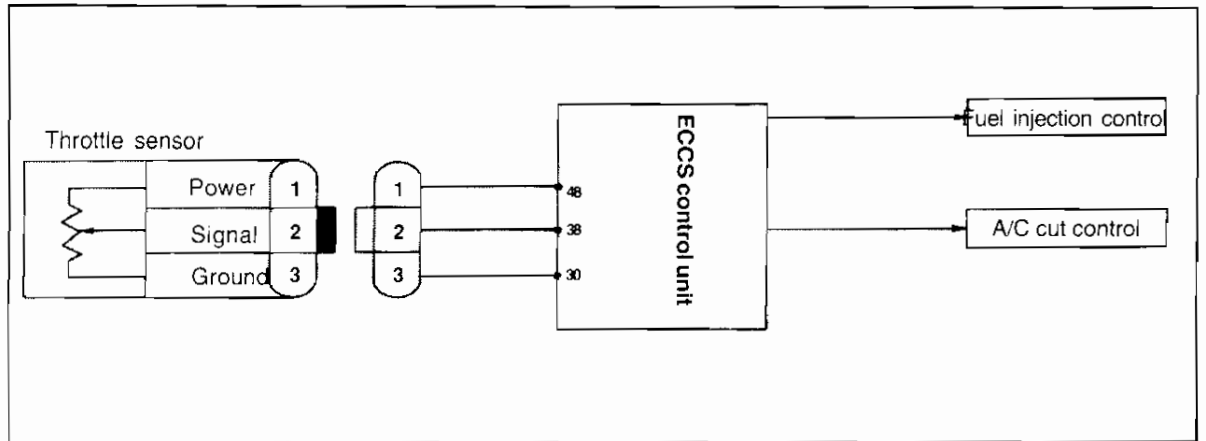

**Components location**

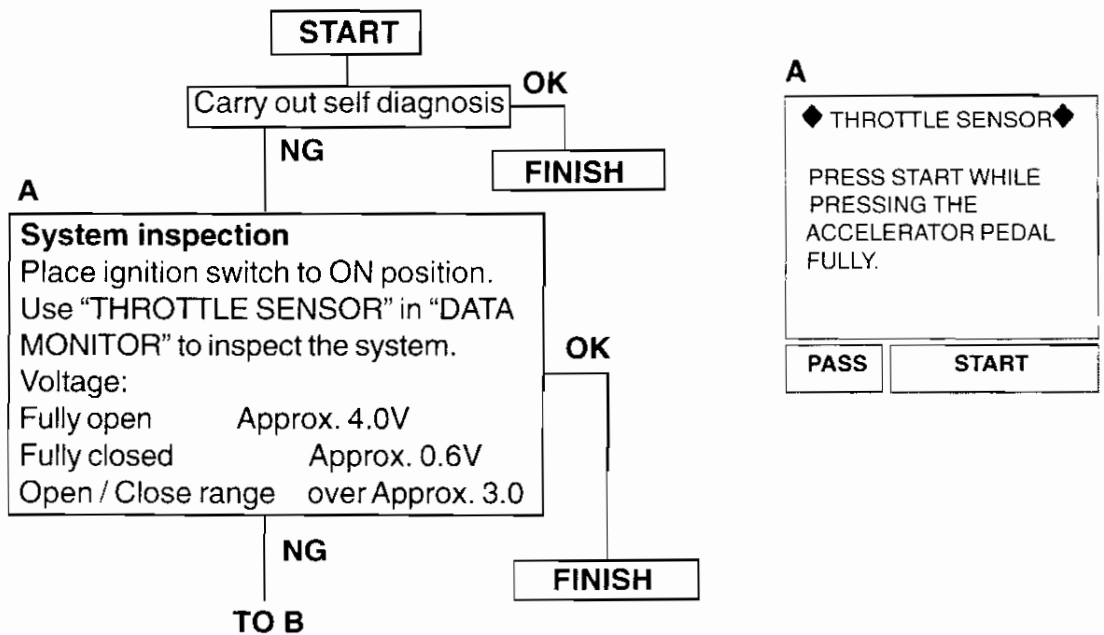
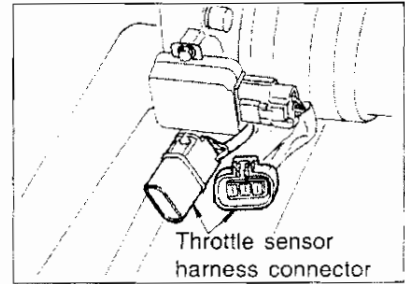
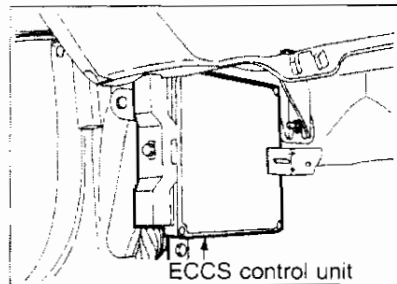

**B**

**Power supply inspection**

⊗ Place ignition switch to ON position. Use "THROTTLE SENSOR" in "DATA MONITOR" to inspect.

⊗ Place ignition switch to OFF position. Disconnect throttle sensor harness connector. Measure the voltage between terminal 1 and ground. Battery voltage : Approx. 5V

NG

OK

Repair harness or connector

**B**

☆ MONITORING ☆ NO FAIL

CAS.RPM (REF) 0rpm  
THROTTLE SEN 3.94V

START

**C**

**Input signal circuit inspection**

Disconnect ECCS C/U harness connector. Check the continuity between ECCS C/U terminal 38 and terminal 2.

NG

Repair harness or connector

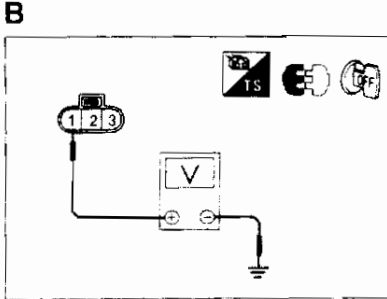

**Component parts inspection (Throttle sensor)**

Refer to the section on throttle sensor for inspection. IF NG: Replace throttle sensor unit.

OK

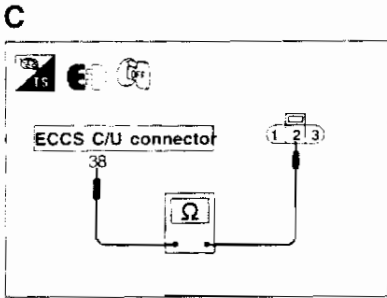

Check for any damage on the ECCS C/U terminals and ECCS C/U connector.

Carry out the inspection in the following order after repairs.

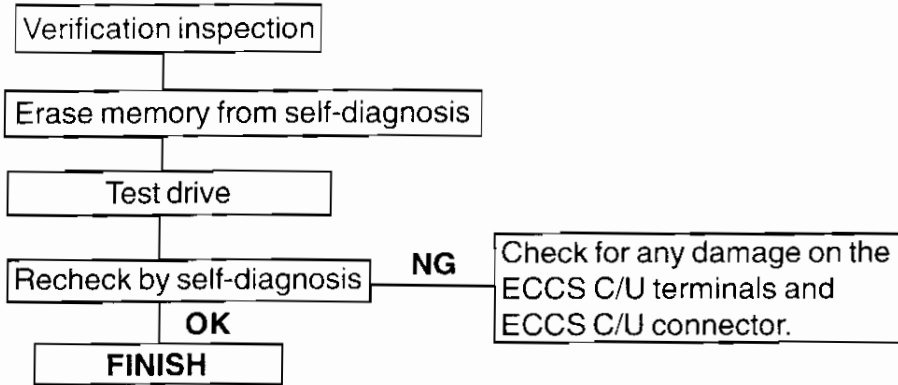

DIAGNOSIS 9 - A / T CONTROL (CODE NO. 54 IN SELF-DIAGNOSIS)

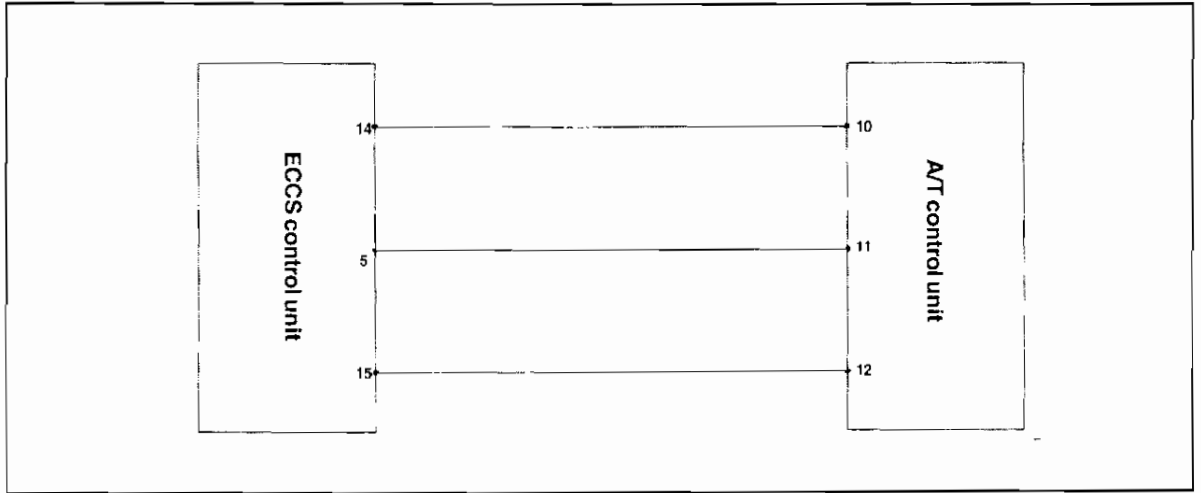

Components location

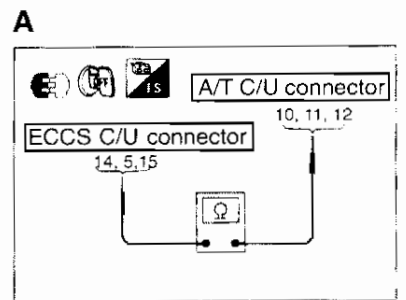
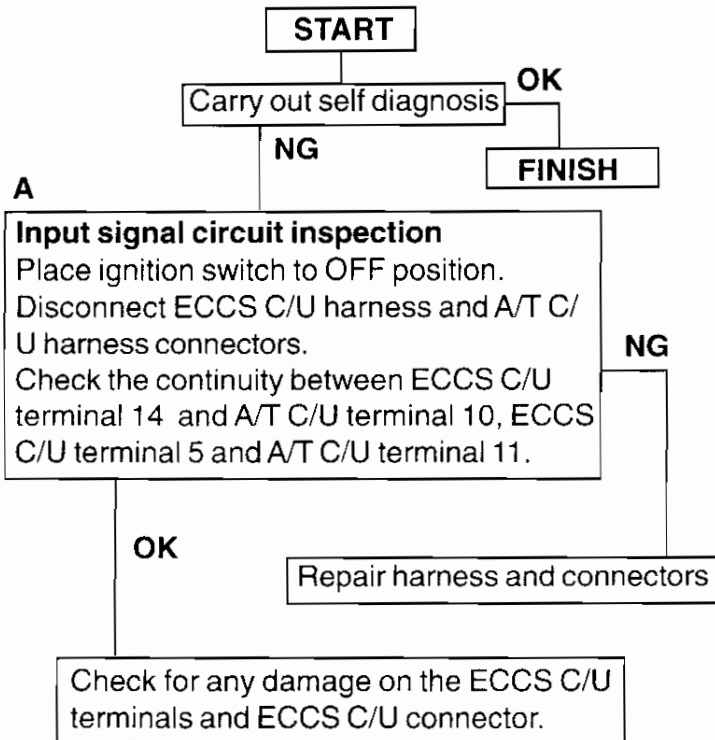
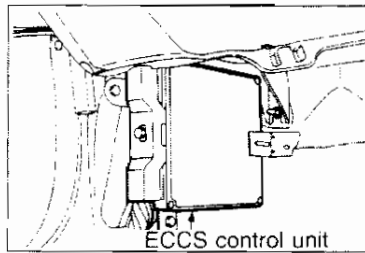

**DIAGNOSIS 10 - CRANK ANGLE SENSOR (NOT IN SELF-DIAGNOSIS)**

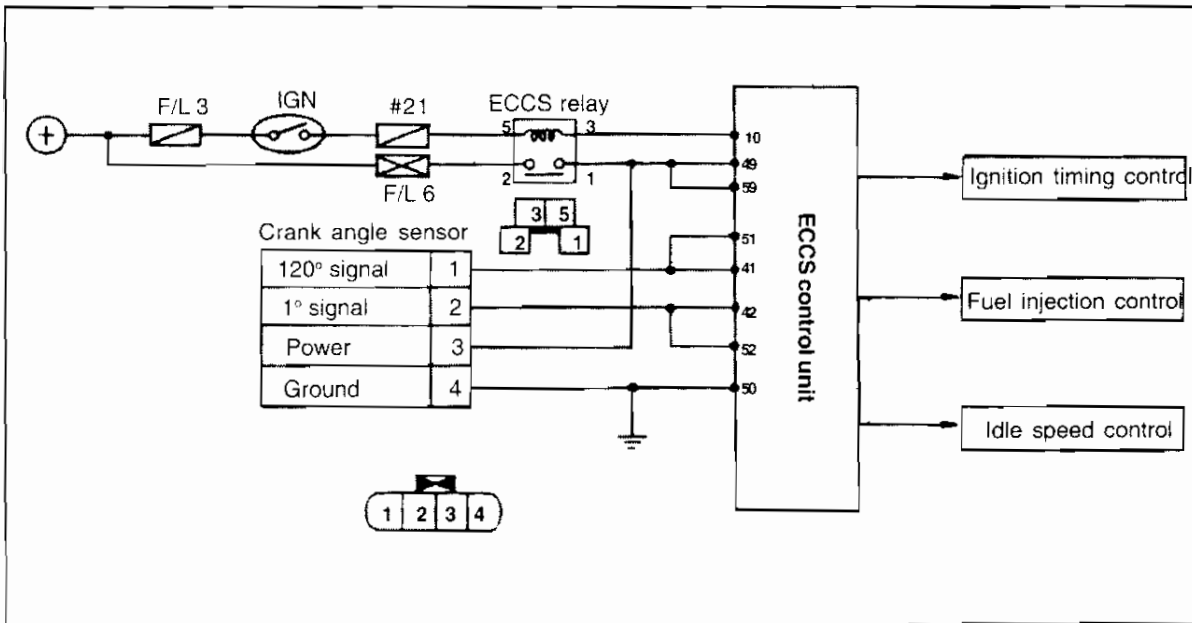

**Components location**

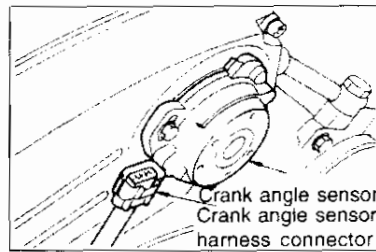
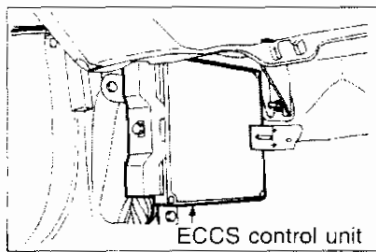



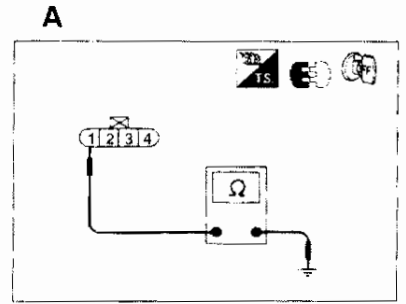
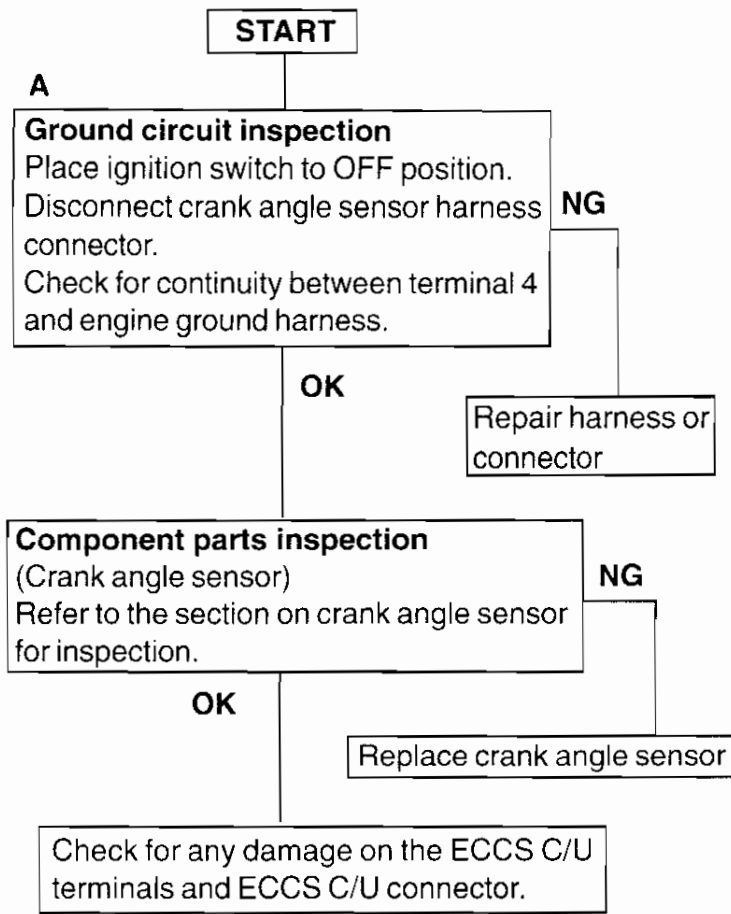

Carry out the inspection in the following order after repairs.

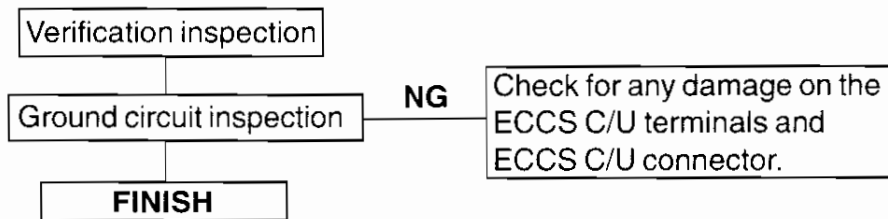

**DIAGNOSIS 11 - IGNITION SIGNAL 1 (CODE NOT IN SELF-DIAGNOSIS)**

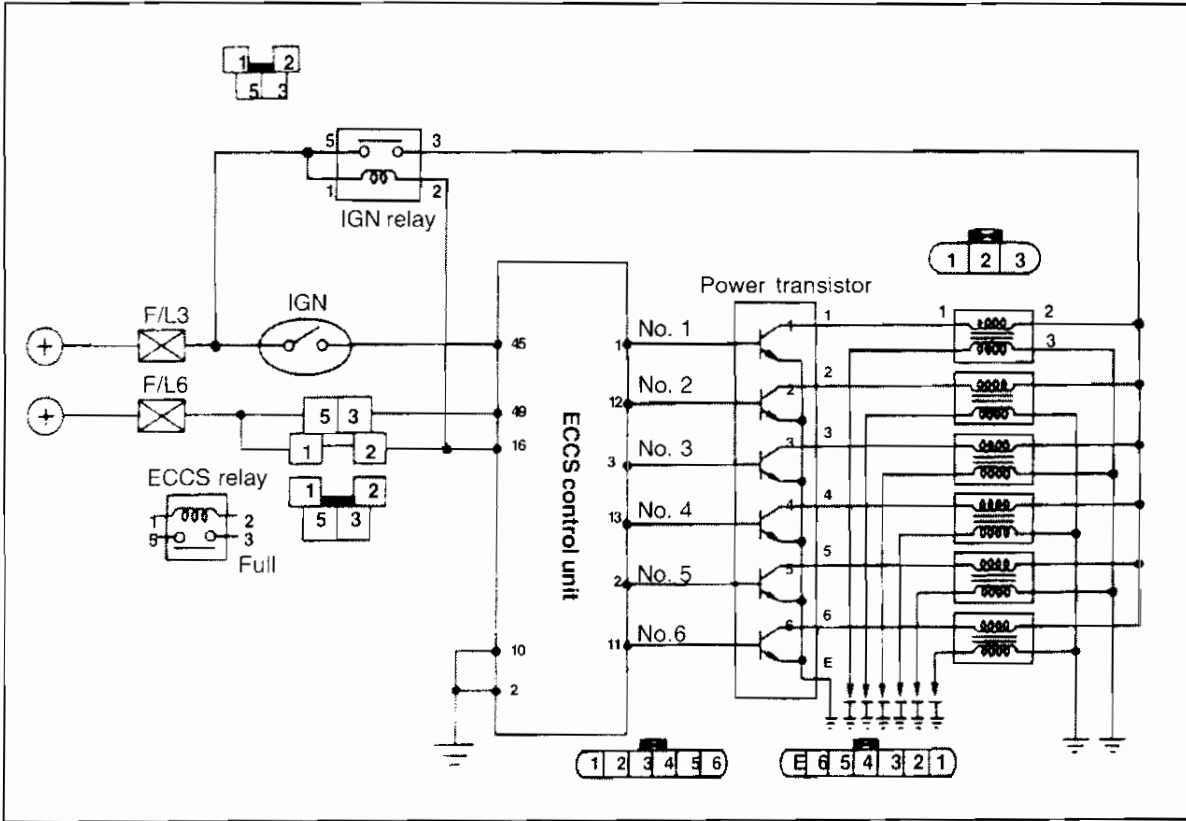

**Components location**

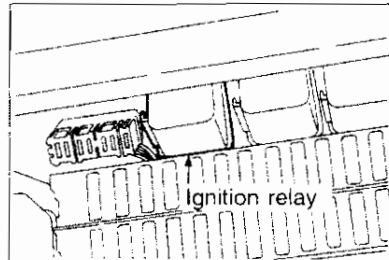
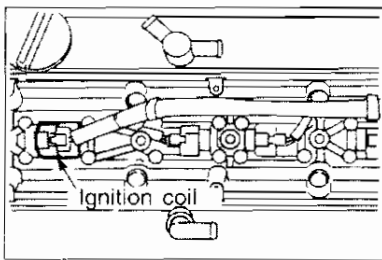
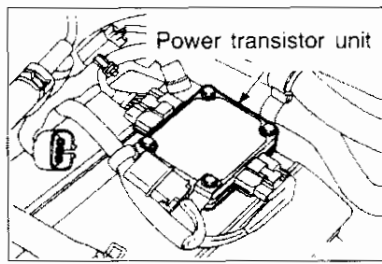
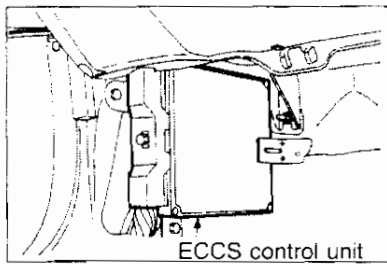

RB25DE ENGINE

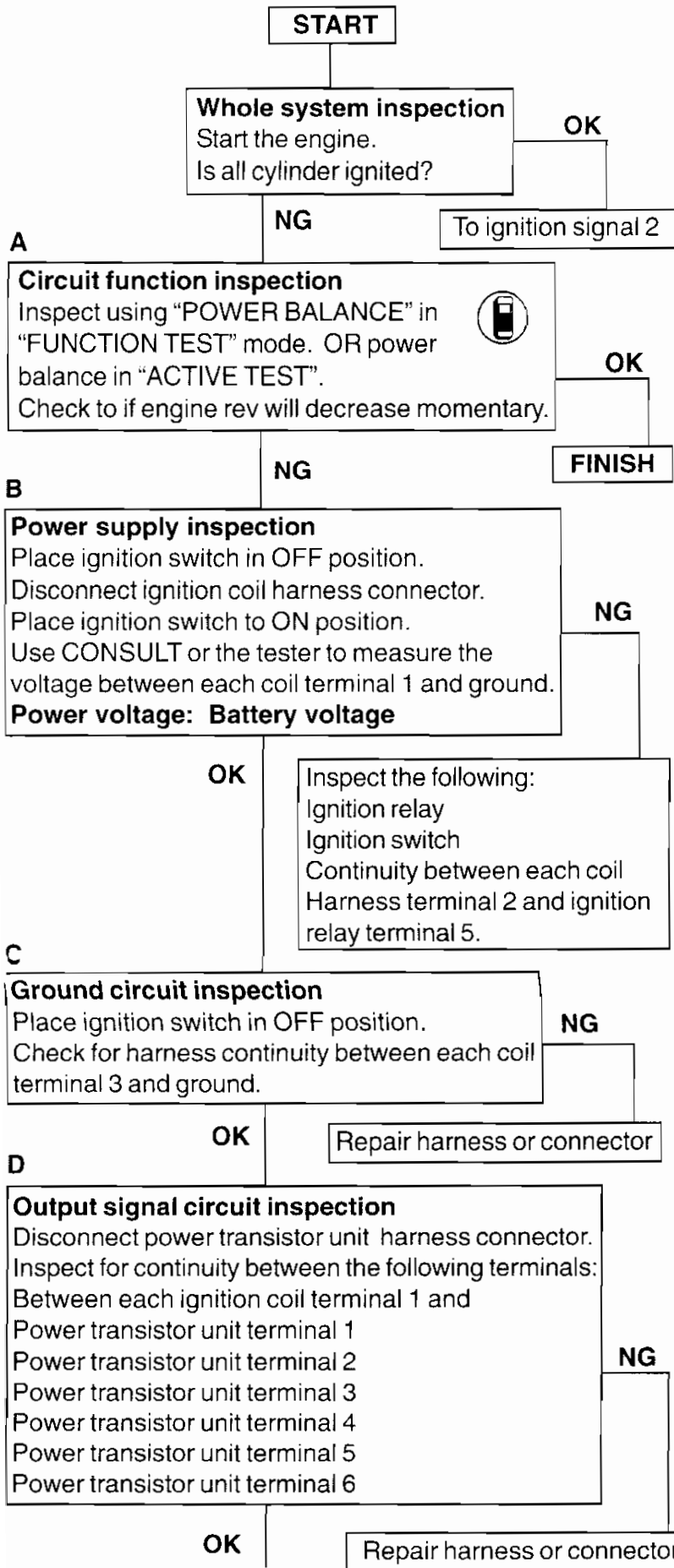

**A**

◆ POWER BALANCE ◆

INSPECT THE BALANCE OF EACH CYLINDER BY STOPPING INJECTOR OPERATION FOR EACH CYLINDER. TURN OFF A/C & LIGHTS

PASS	START
------	-------

**A**

◆ ACTIVE TEST ◆

POWER BALANCE MONITOR

CAS.RPM(POS)	rpm
AIR FLOW METER	V
AAC VALVE	%

1	2	3	4	MONITOR
5	6			START

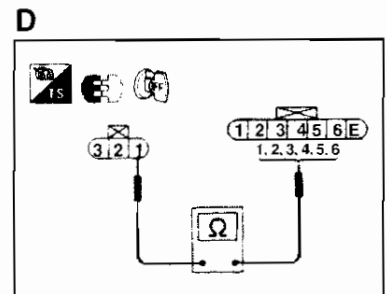
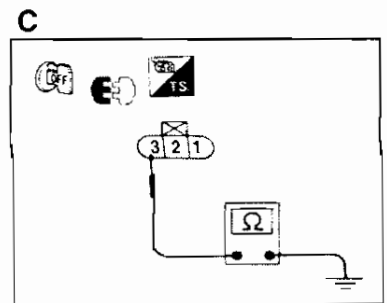
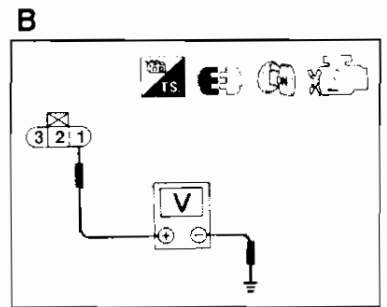

RB25DE ENGINE

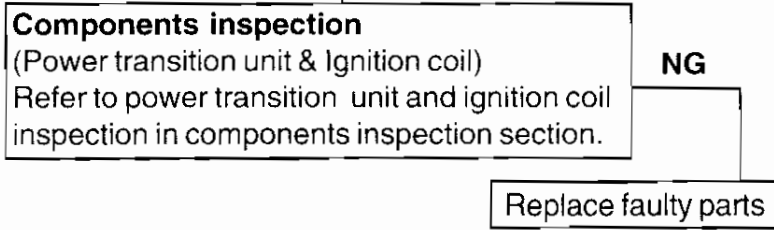

Carry out the inspection in the following order after repairs:

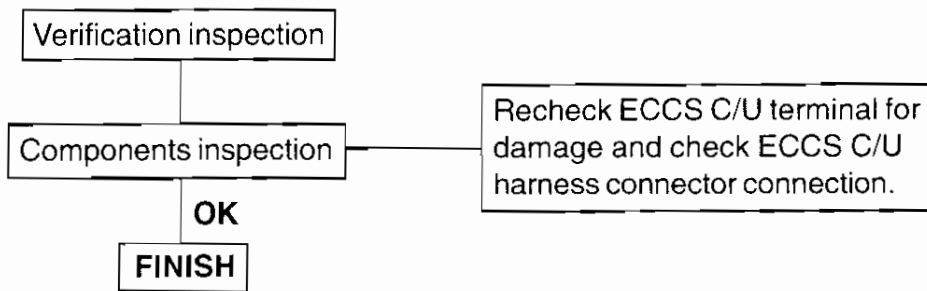

**DIAGNOSIS 11 - IGNITION SIGNAL 2**

Continue from ignition signal 1

**E**

**Power supply inspection**  
 Place ignition switch in OFF position.  
 Disconnect ignition coil relay connector.  
 Place ignition switch to ON position.  
 Use CONSULT or tester to measure the voltage between coil terminal 2, 3 and ground.  
**Power voltage: Battery voltage**

**E**

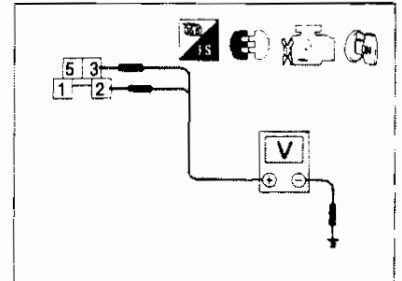

**OK**

Inspect the following:  
 Continuation between fusible link, ignition coil relay and ignition switch.  
 Continuation between ignition coil relay and the battery.

**F**

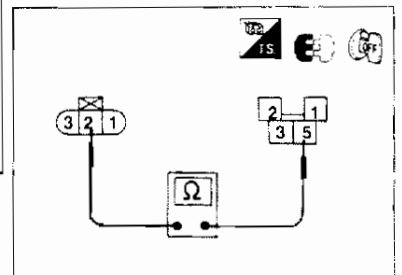

**F**

**Ground circuit inspection**  
 Place ignition switch to OFF position.  
 Inspect harness continuation between each coil terminal 2 and 5.

**NG**

**OK**

Repair harness and / or connector

**G**

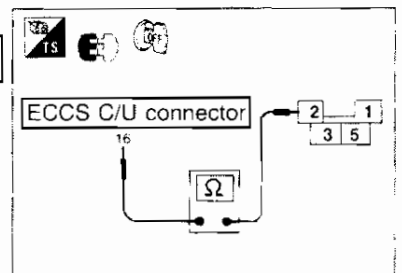

**G**

**Output signal circuit inspection**  
 Disconnect ECCS relay.  
 Inspect the continuation between ECCS C/U terminal 16 and ECCS relay terminal 2.

**NG**

**OK**

Inspect the following:  
 Fusible link.  
 Continuation between ECCS C/U and ECCS relay harness.  
 Continuation between ECCS C/U and ignition coil relay harness.  
 IF NG: Repair harness and connector.

**Components inspection**  
 (Ignition coil & ECCS relay)  
 Refer to ignition coil and ECCS relay inspection in components inspection section.

**NG**

**OK**

Replace faulty components

Inspect ECCS C/U terminal for any damage and ECCS C/U connector for connection.

DIAGNOSIS 12 - INJECTOR SYSTEM INSPECTION

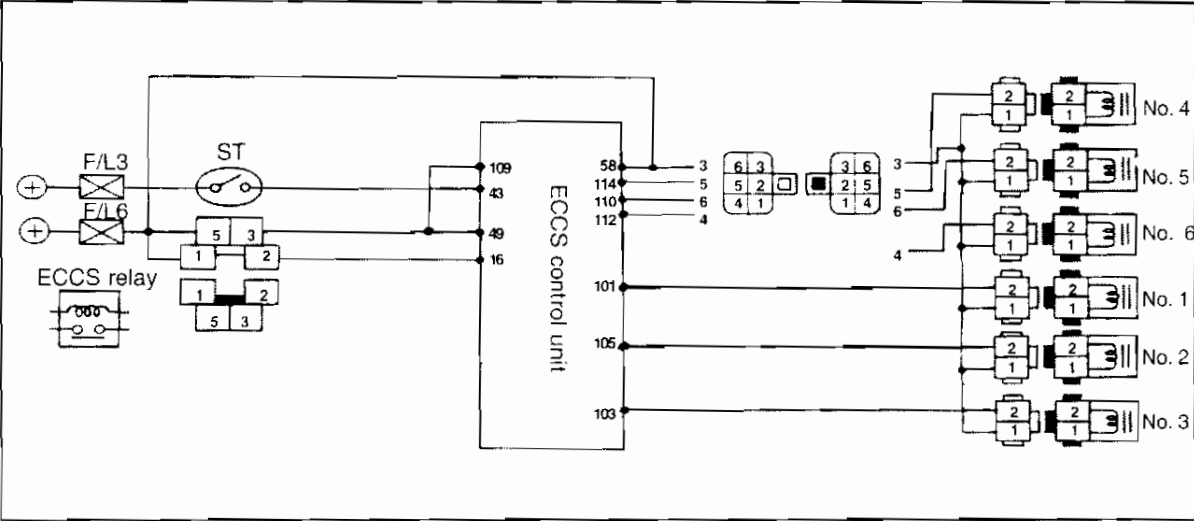

Components location

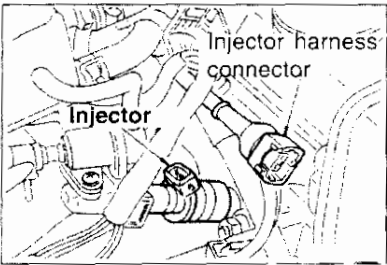
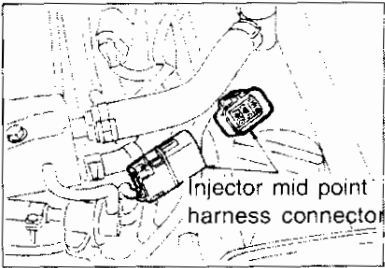
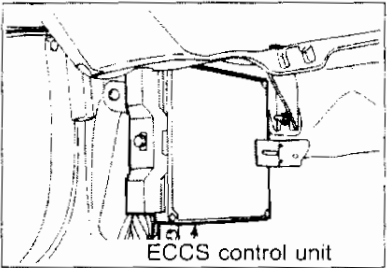

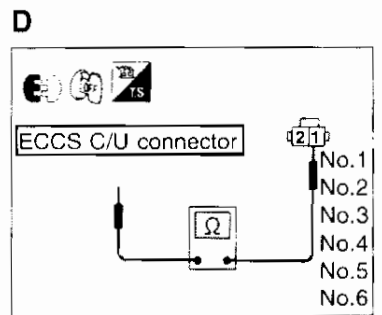
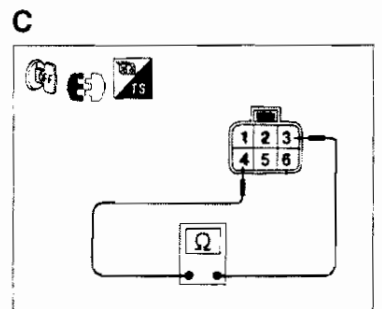
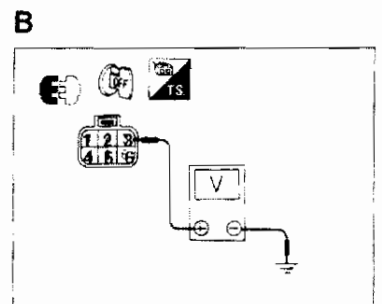
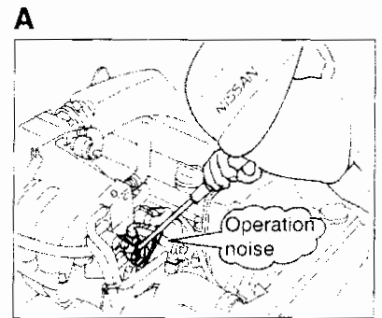
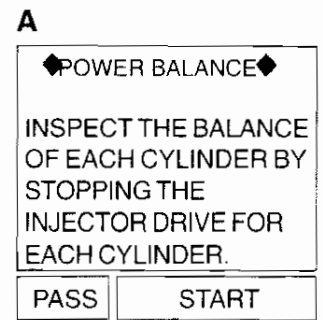
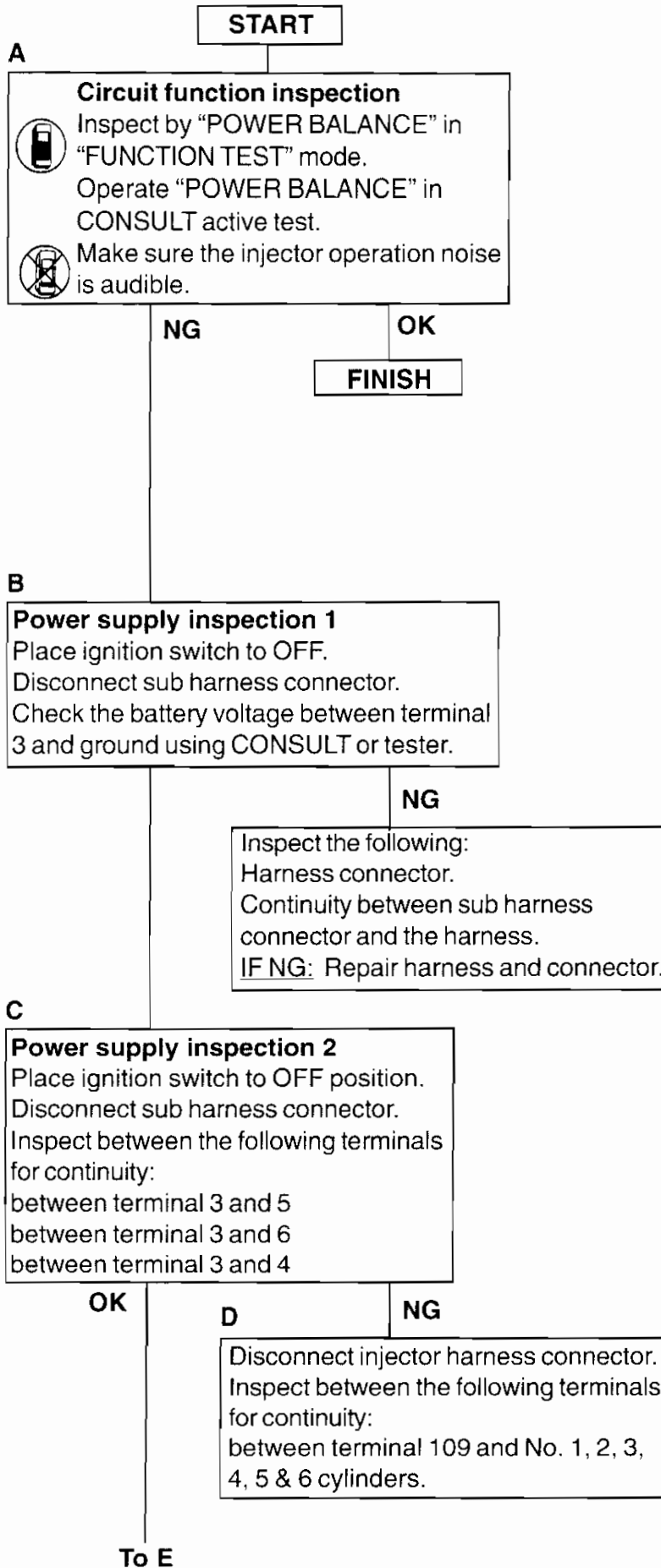

**E**

**Out put circuit inspection**

Disconnect ECCS C/U harness connector. Inspect between the following terminals for continuity:

- between terminal 101 and No. 1 cylinder
- between terminal 105 and No. 2 cylinder
- between terminal 103 and No. 3 cylinder
- between terminal 112 and No. 4 cylinder
- between terminal 110 and No. 5 cylinder
- between terminal 114 and No. 6 cylinder

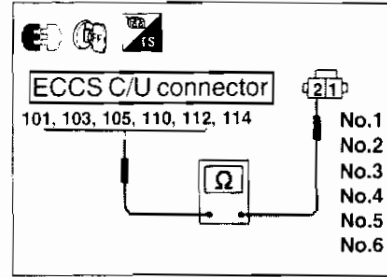

OK

NG

Repair harness or connector.

**Component parts inspection**

(Injector)  
Refer to the section on injector for inspection.

NG

Replace injector.

Inspect ECCS C/U terminals for any damage and make sure the connectors are connected correctly.

**Carry out the inspection in the following order after repairs:**

Verification inspection

Functional check.

OK

Recheck for any damage on the ECCS C/U terminals and ECCS C/U connector.

NG

**FINISH**



**DIAGNOSIS 13 - VEHICLE SPEED SENSOR**

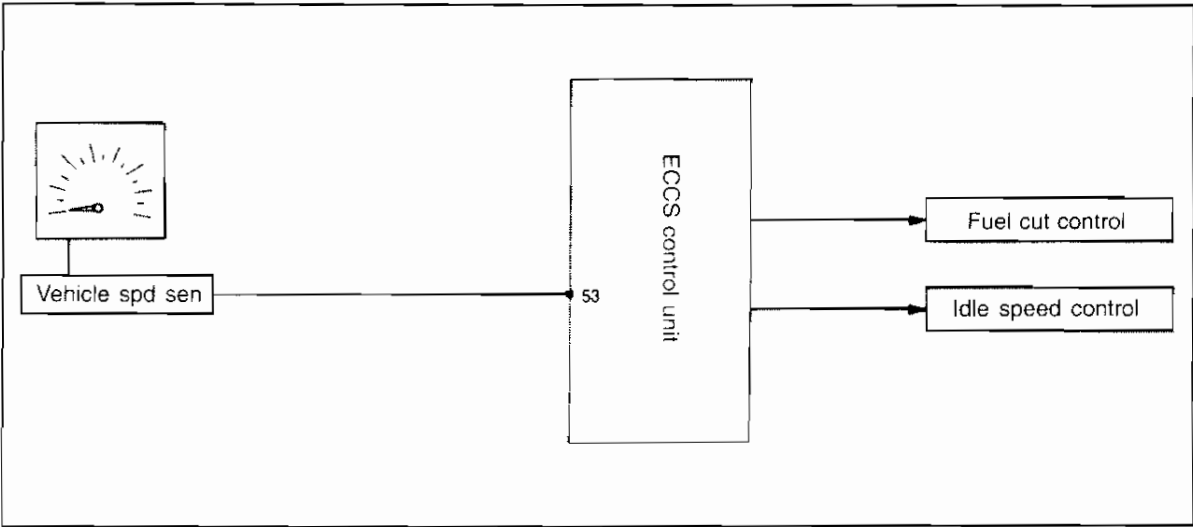

**Components location**

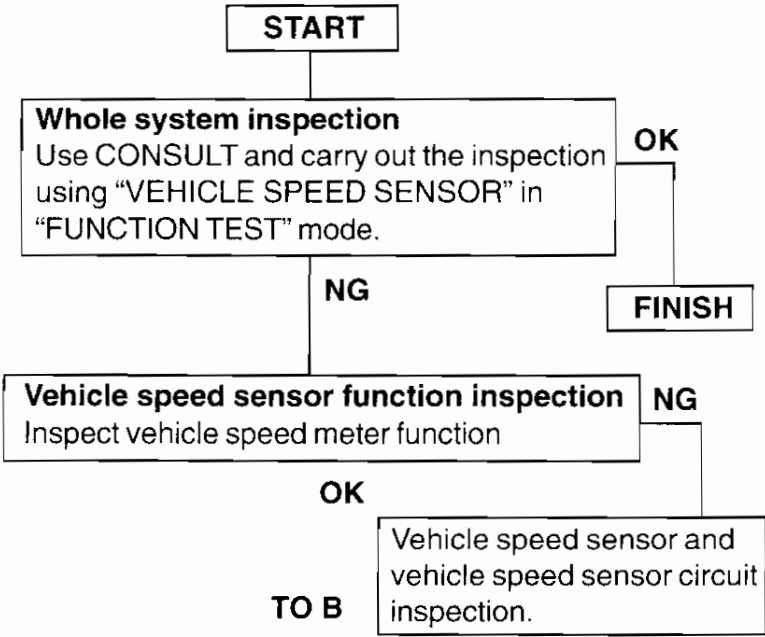
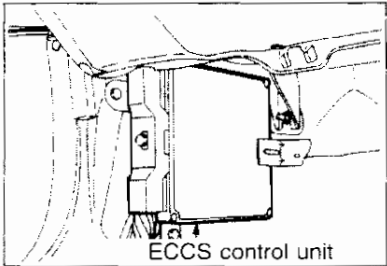

RB25DE ENGINE

**B**

**Input signal inspection**  
 Start the engine.  
 Rotate drive axle slowly.

 Detect vehicle speed using "VEHICLE SPEED SENSOR" in "DATA MONITOR".

 Use tester to measure the voltage between ECCS C/U terminal 53 and ground.  
 Voltage: approx. 0 ~ 5V

**NG**

**B**

☆ MONITORING ☆ NO FAIL

CAS.RPM (POS) 787rpm  
 VEH SPD SEN 0 km/h

**START**

**OK**

**Inspect the following:**  
 Check the continuity between ECCS C/U and combination meter harness.  
 IF NG: Repair or replace harness.

**B**

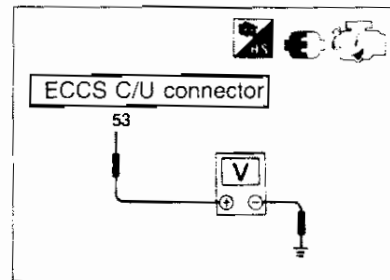

Inspect ECCS C/U terminals for any damage and make sure the connectors are connected correctly.

Carry out the inspection in the following order after repairs.

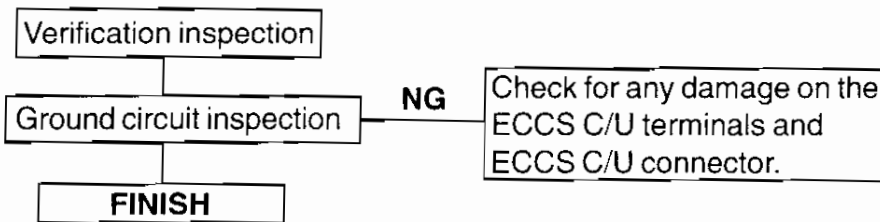

**DIAGNOSIS 14 - AIR CONDITIONER RELAY SIGNAL**

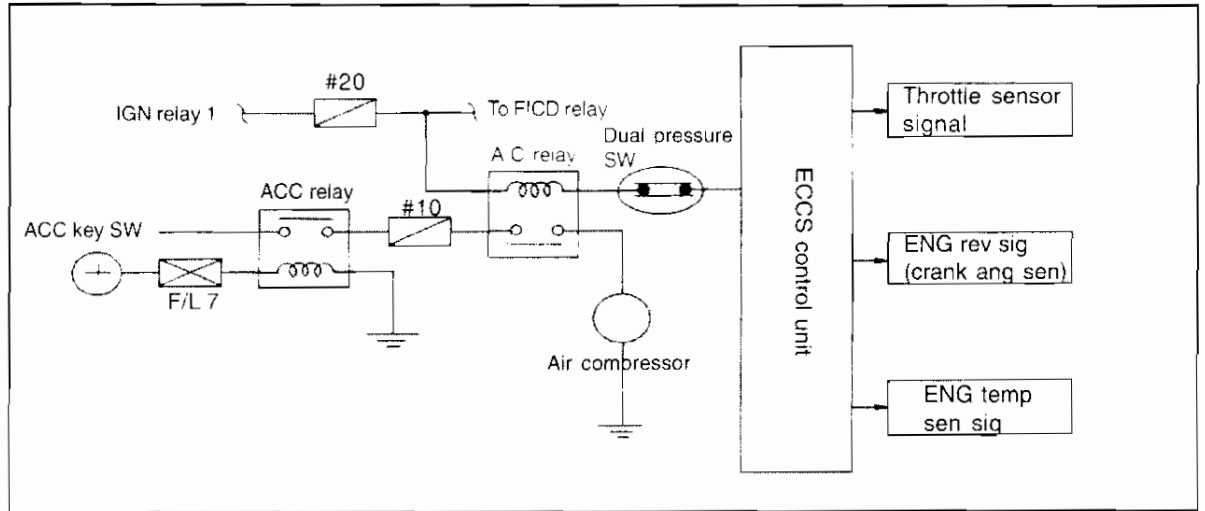

**Components location**

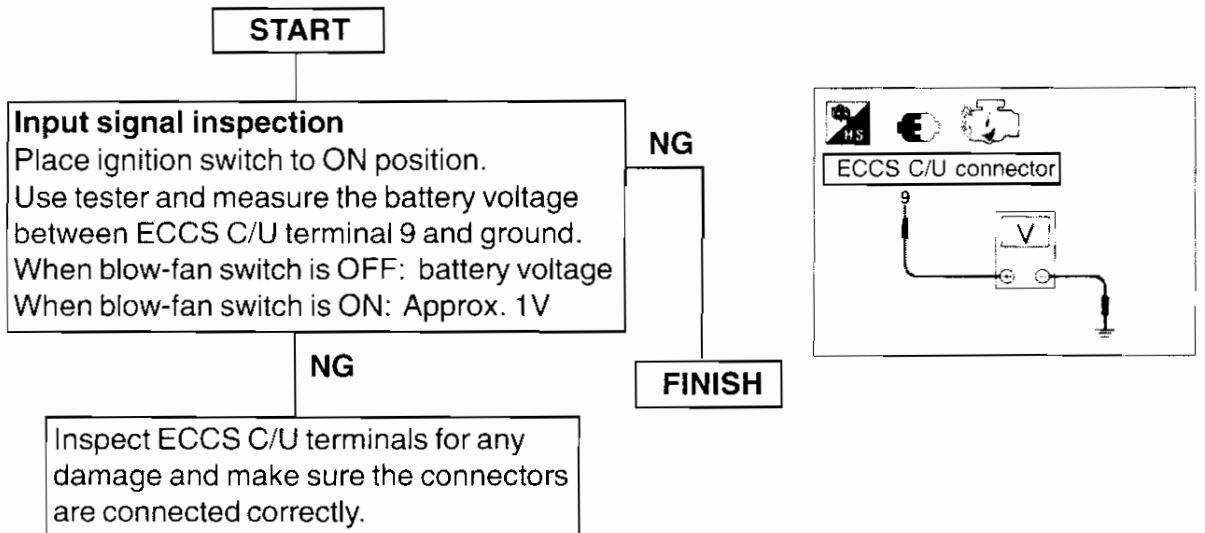
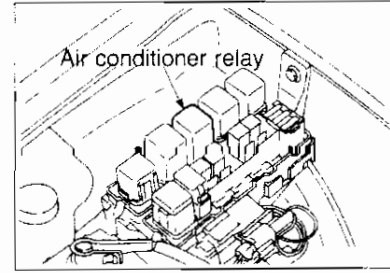
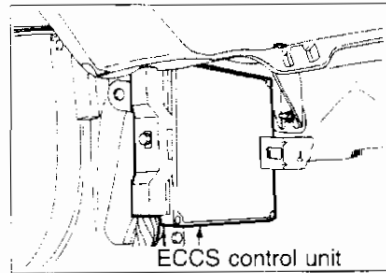

Carry out the inspection in the following order after repairs.

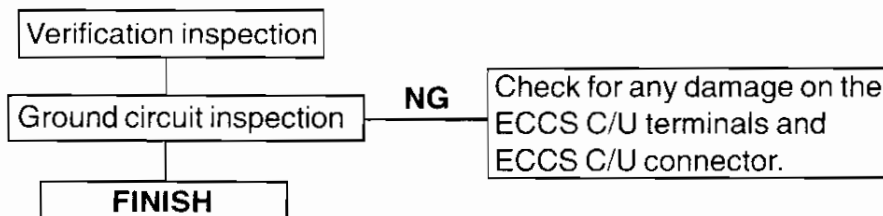

DIAGNOSIS 15 - EXHAUST GAS SENSOR HEATER

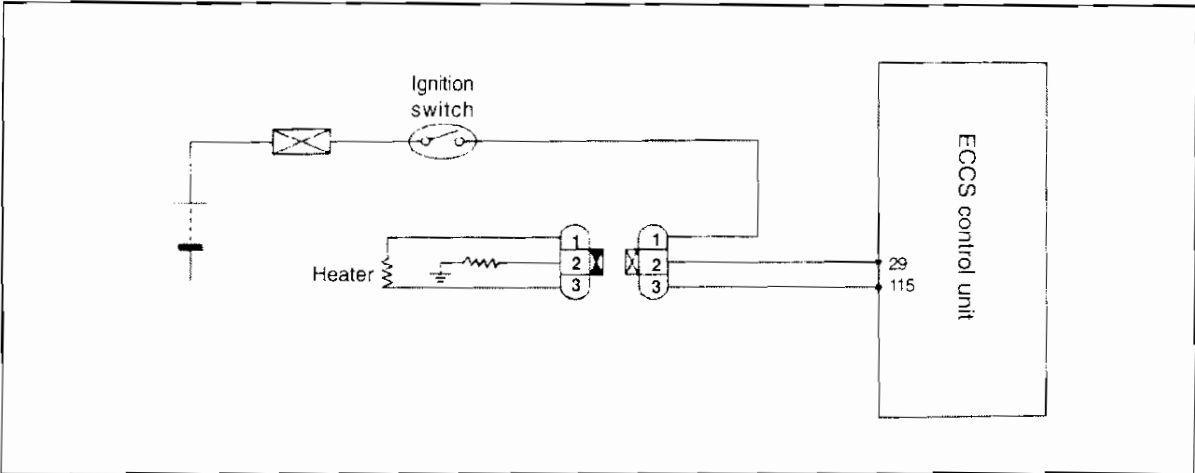

Components location

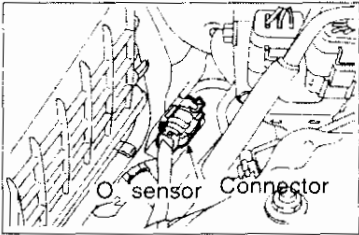
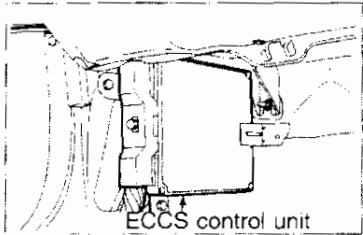

RB25DE ENGINE

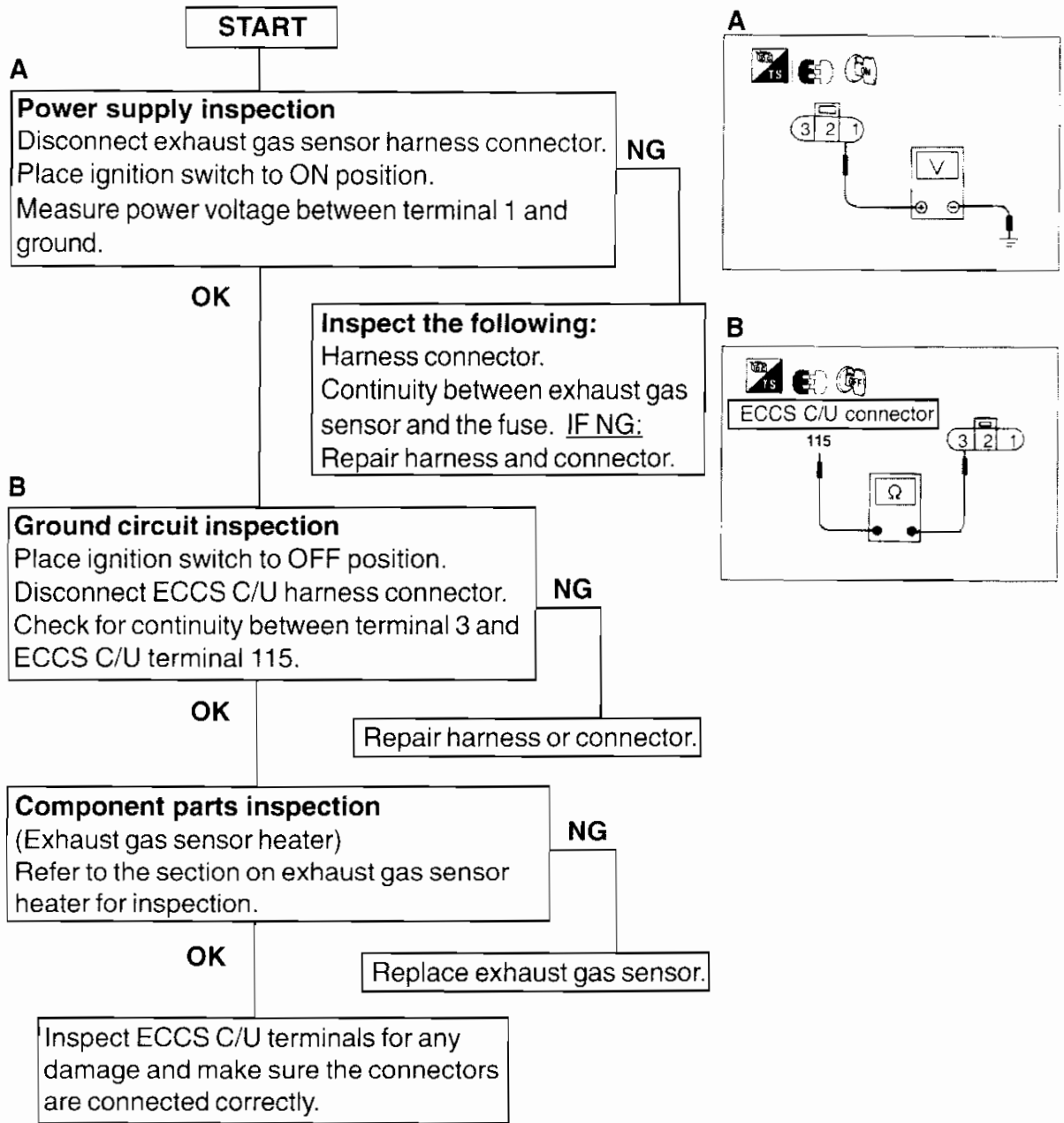

Carry out the inspection in the following order after repairs.

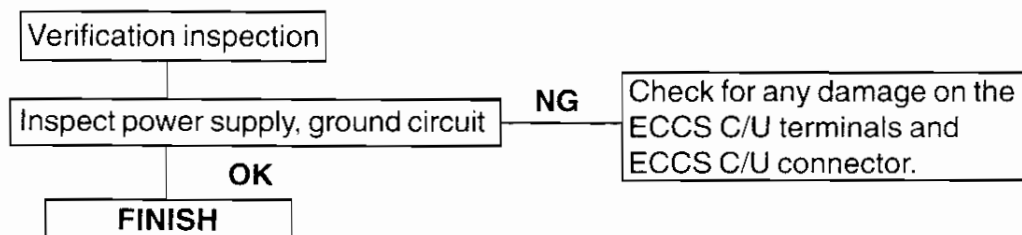

DIAGNOSIS 16 - THROTTLE VALVE SWITCH

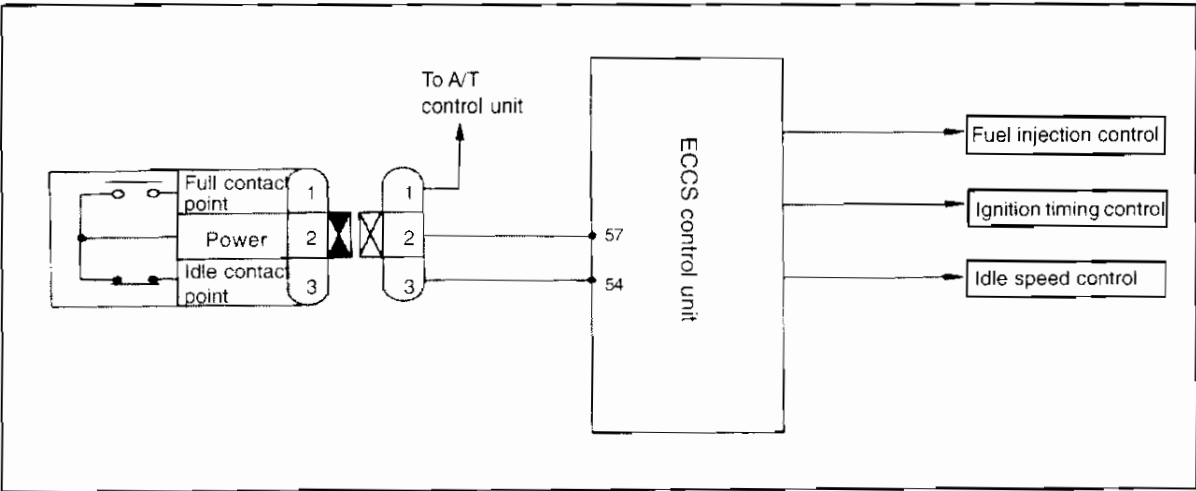

Components location

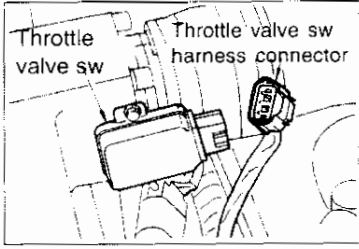
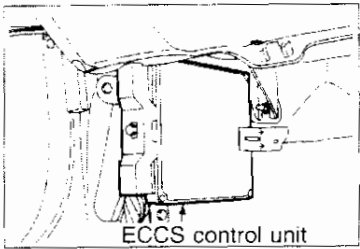

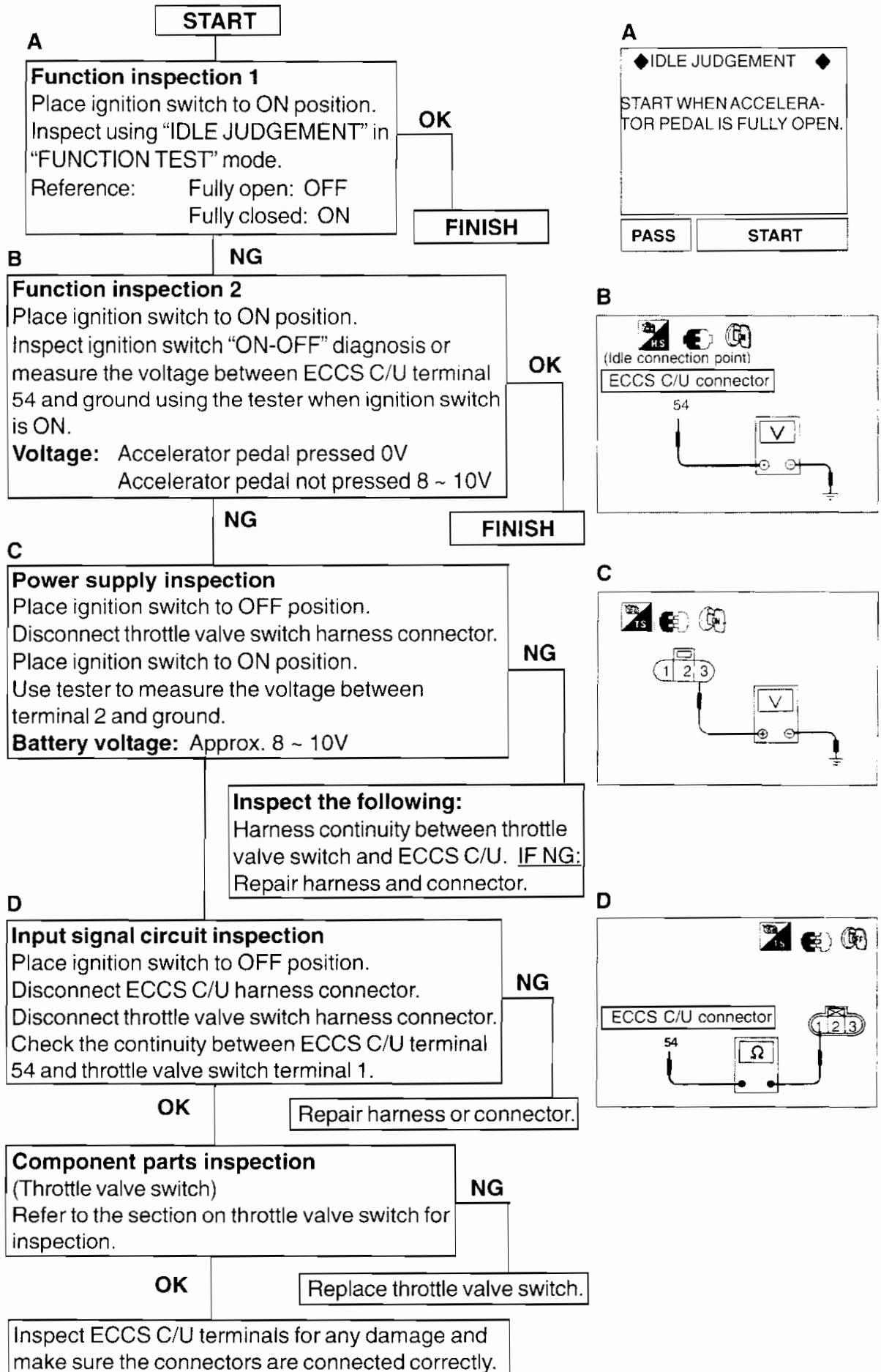

## RB25DE ENGINE

Carry out the inspection in the following order after repairs.

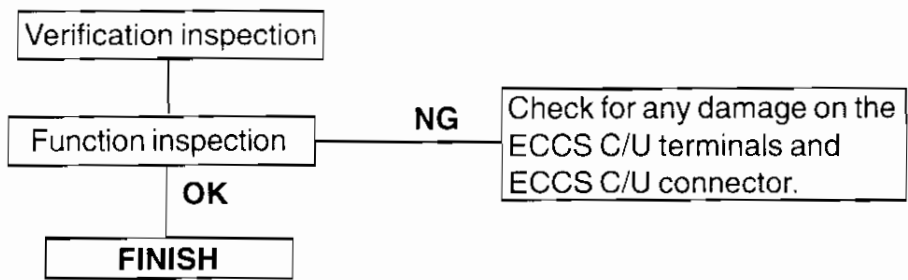



**DIAGNOSIS 17 - START SIGNAL**

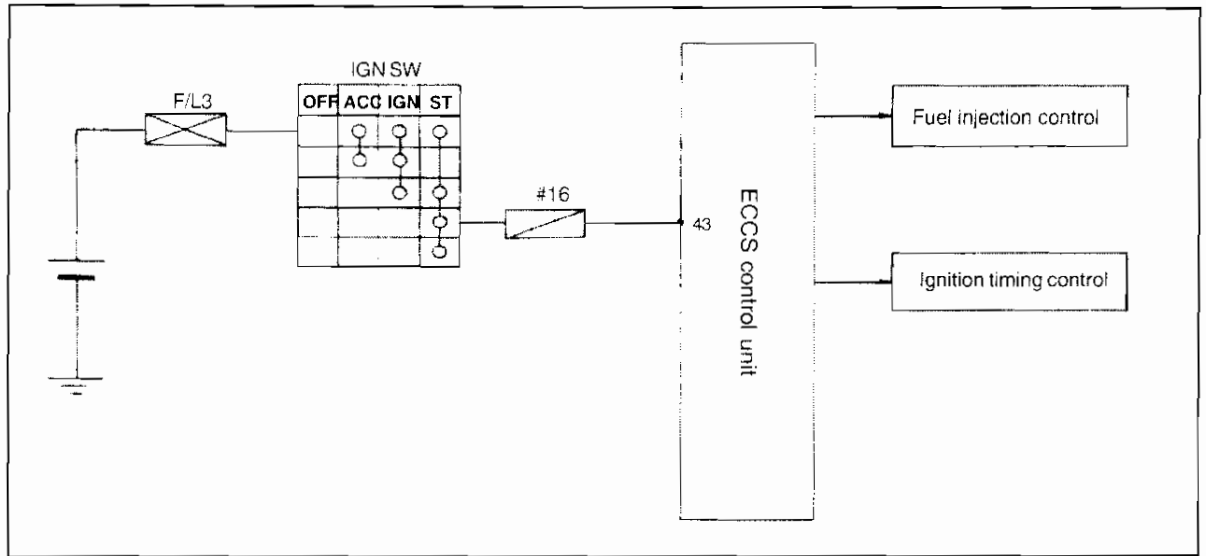

**START**

**A**

**Function inspection**

Place ignition switch to ON position.  
Use CONSULT and inspect "START SIGNAL" in "FUNCTION TEST" mode.

OR

Place ignition switch to ON position.  
Inspect start signal using "DATA MONITOR" mode.  
When ignition switch is ON position: OFF  
When ignition switch is START position: ON

**OK**

**A**

◆ STARTER SIGNAL ◆

PLACE SHIFT LEVER TO "P" OR "N" WITH ACCELERATOR PEDAL FULLY CLOSED.  
START THE ENGINE STRAIGHT AFTER SELECTING START.

PASS
START

**B**

**Power supply inspection**

Place ignition switch to OFF position.  
Disconnect throttle valve switch harness connector.  
Place ignition switch to ON position.  
Use tester to measure the voltage between terminal 2 and ground.  
**Battery voltage:** Approx. 8 ~ 10V

**NG**

**FINISH**

**B**

**Inspect the following:**

Fuse  
Continuity between ignition switch and ECCS C/U harness. **IF NG:**  
Repair harness and connector.

**OK**

**B**

ECCS C/U connector

43

Inspect ECCS C/U terminals for any damage and make sure the connectors are connected correctly.

DIAGNOSIS 18 - FUEL PUMP CONTROL

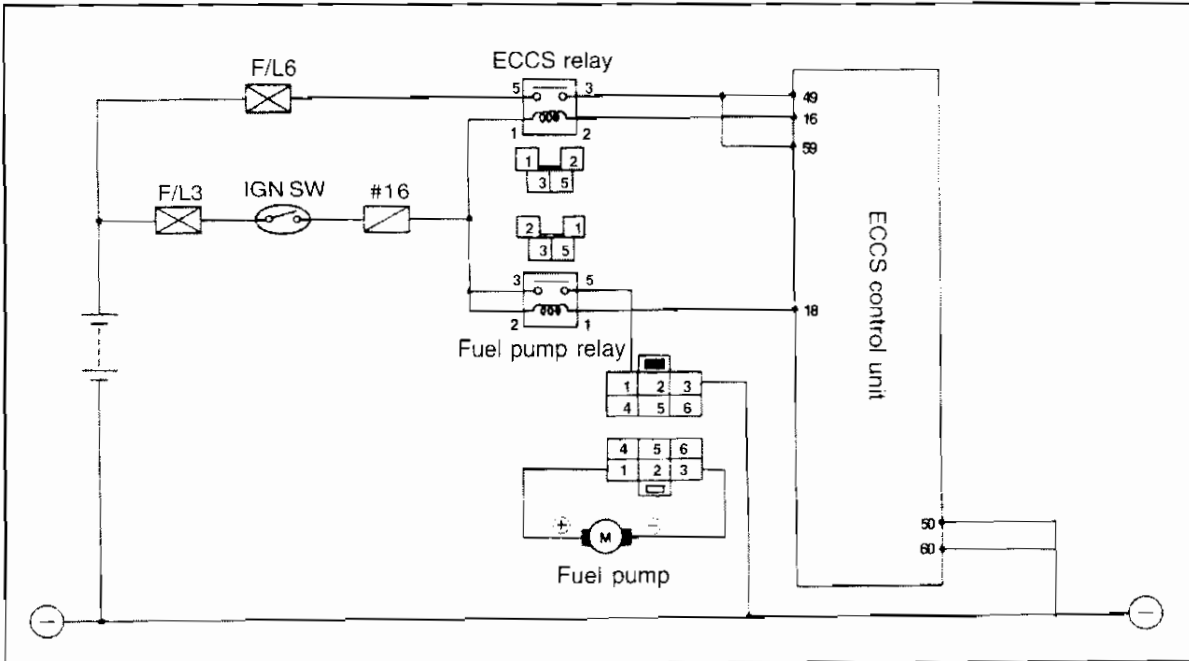

Components location

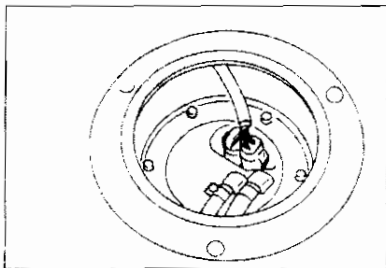
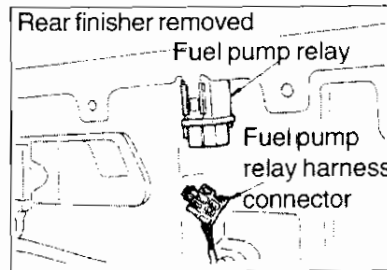
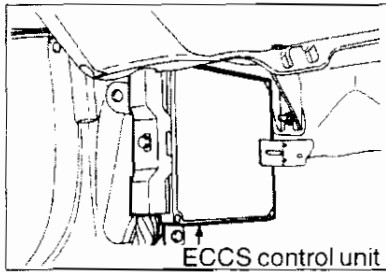

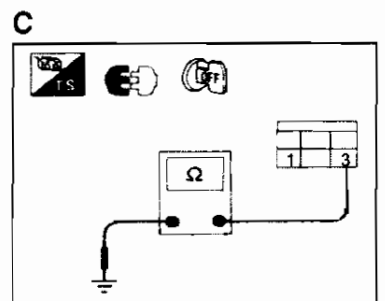
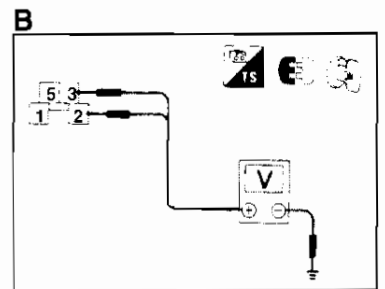
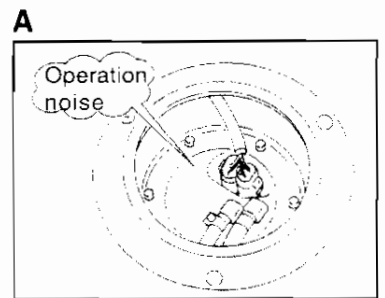
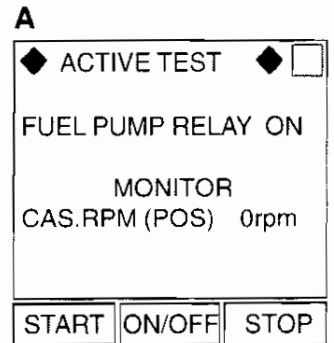
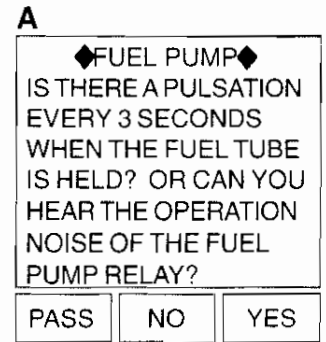
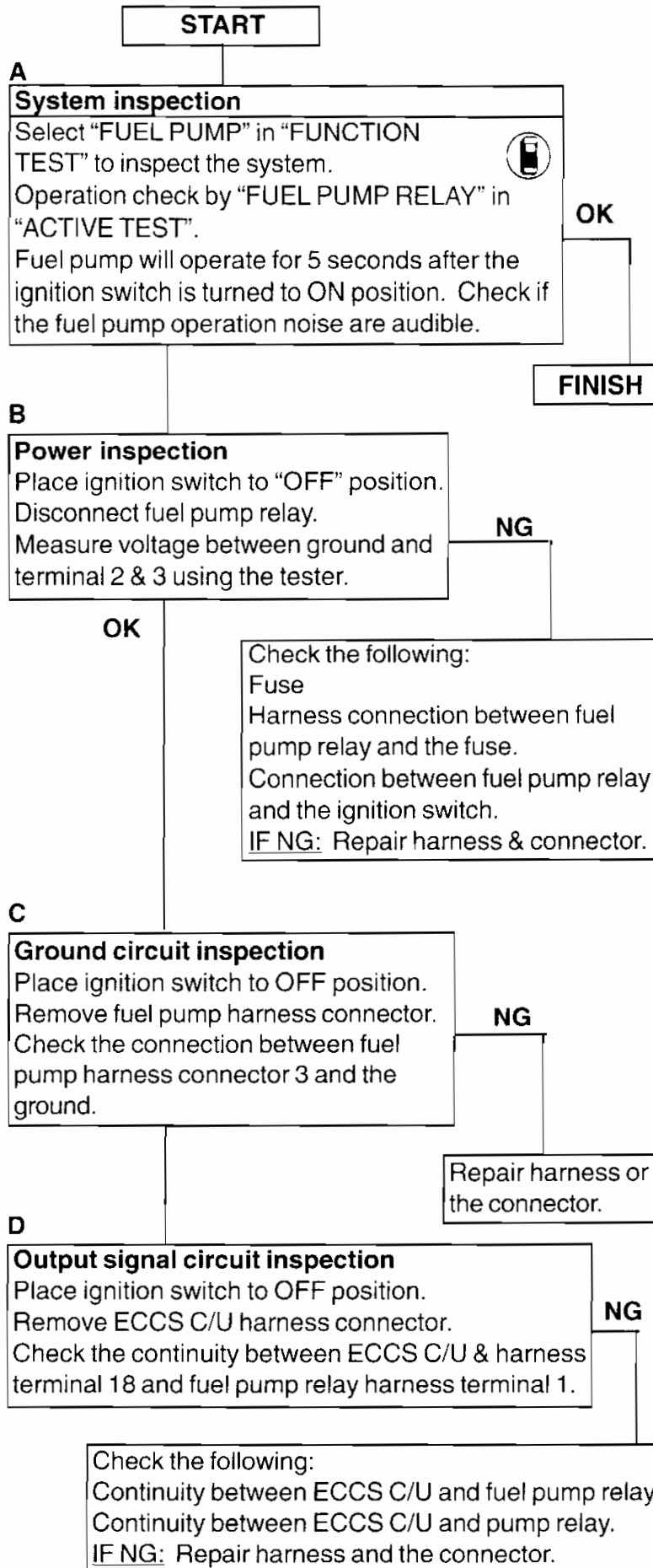

**E**  
**Control signal inspection**  
 Measure the voltage between ground and ECCS C/U terminal 18.  
**5 seconds after ignition switch is turned ON: 1V**  
**After 5 seconds after ignition switch is turned ON: Battery voltage**

OK

**Component parts inspection**  
 (Fuel pump relay)  
 Refer to the section on fuel pump relay for inspection.

NG

Replace fuel pump relay.

**Component parts inspection**  
 (Fuel pump)  
 Refer to the section on fuel pump for inspection.

NG

Replace fuel pump.

OK

Check for any damage on the ECCS C/U terminals and ECCS C/U connector.

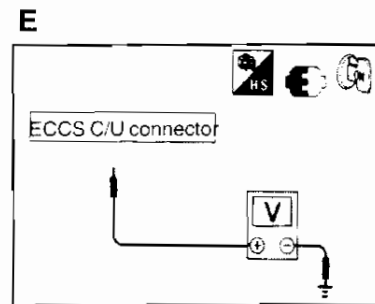
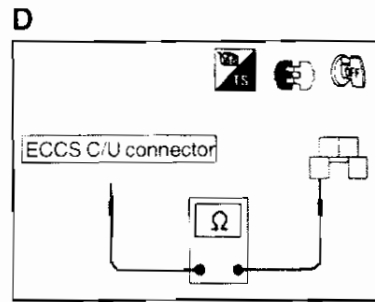

Carry out the inspection in the following order after repairs.

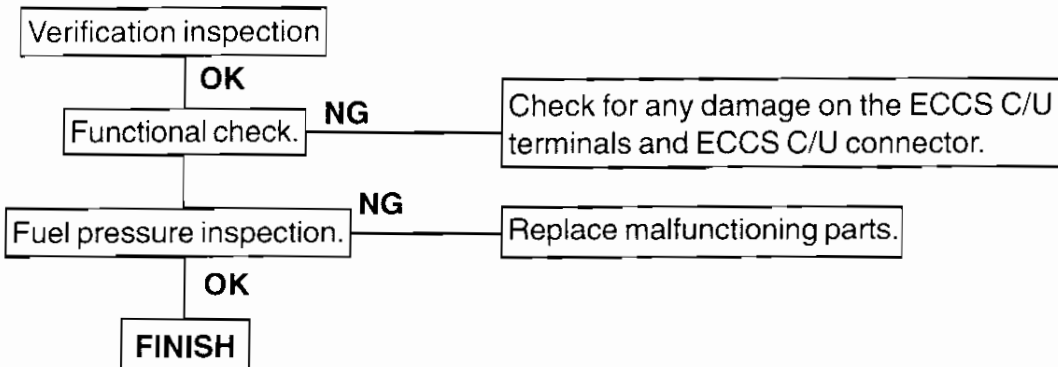

**DIAGNOSIS 19 - AAC VALVE**

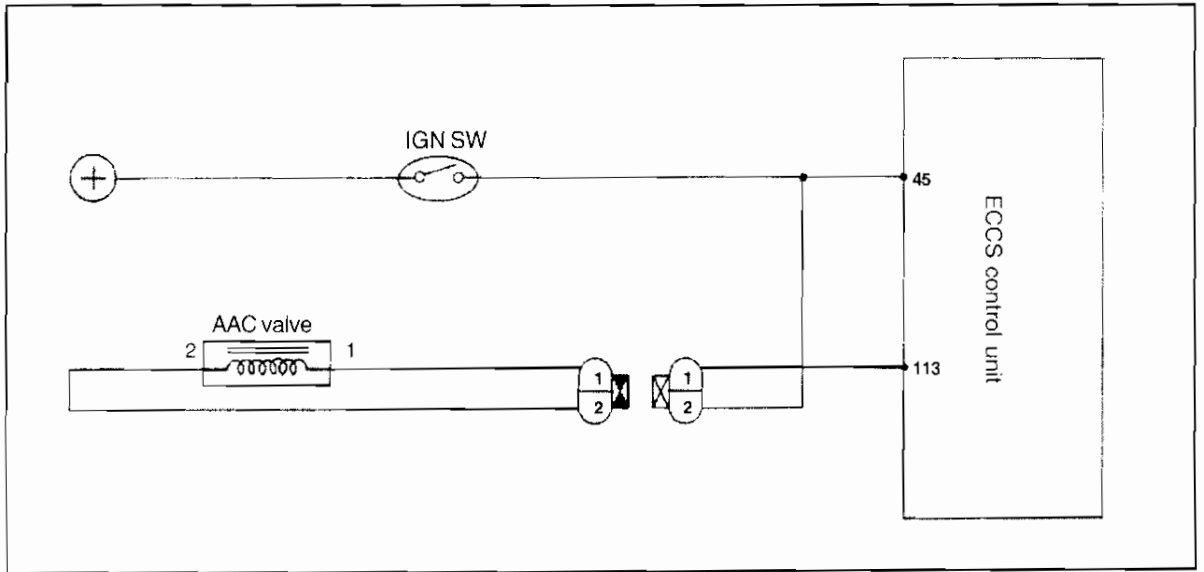

**Components location**

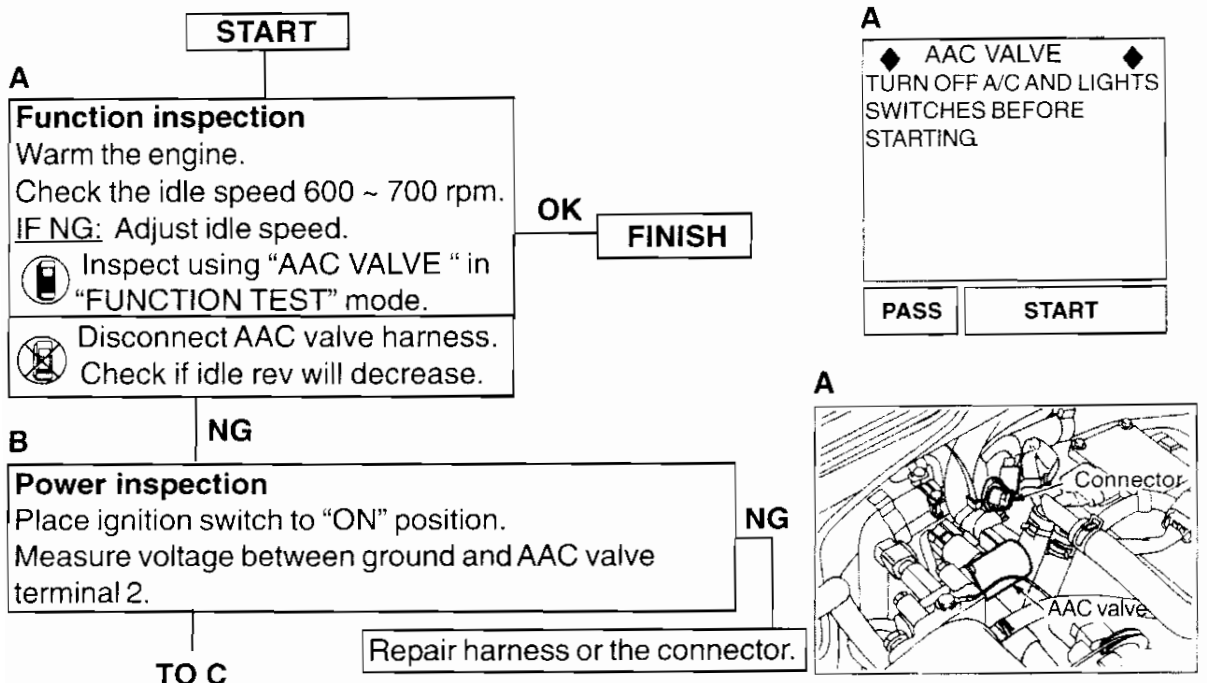
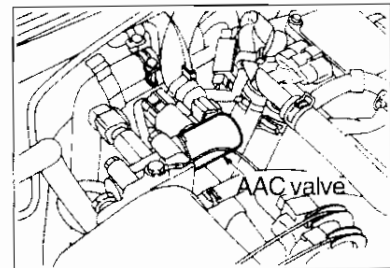
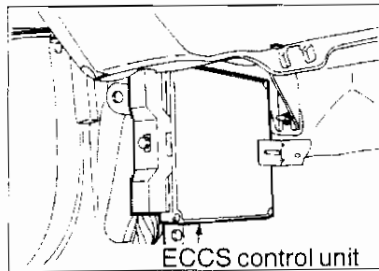

C

**Output signal circuit inspection**

- Check if the engine rev will change when the "UP" or "DOWN" is pressed in "AAC VALVE" in "ACTIVE TEST" mode.
- Disconnect ECCS C/U harness.
- Check for continuity between ECCS C/U harness terminal 4 and AAC valve connector terminal 1.

NG

OK

Repair harness or connector.

B

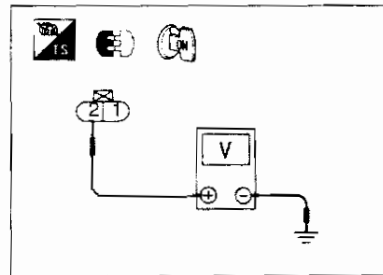

C

◆ ACTIVE TEST ◆

AAC/V OPENING DEG 10%  
 MONITOR  
 CAS.RPM (POS) 900rpm  
 AIR FLOW MTR 1.16V  
 ENGINE TEMP SEN 80°C

Qu UP DWN Qd

**Component parts inspection (AAC valve)**  
 Refer to the section on AAC valve for inspection.

NG

OK

Replace AAC valve.

Check for any damage on the ECCS C/U terminals and ECCS C/U connector.

C

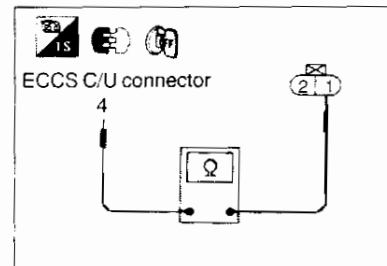

Carry out the inspection in the following order after repairs.

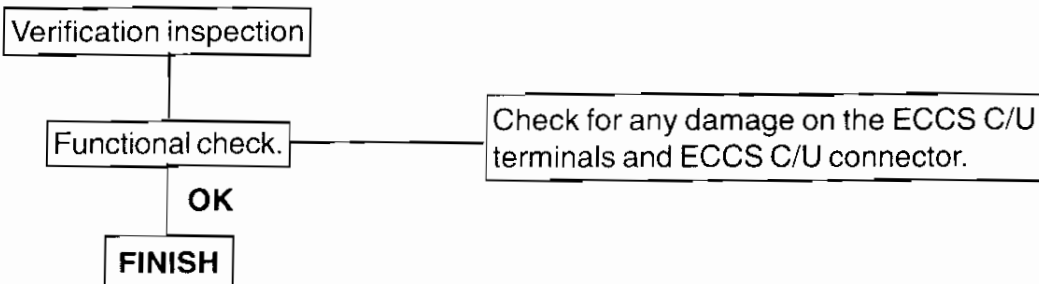

**DIAGNOSIS 20 - AIR REGULATOR**

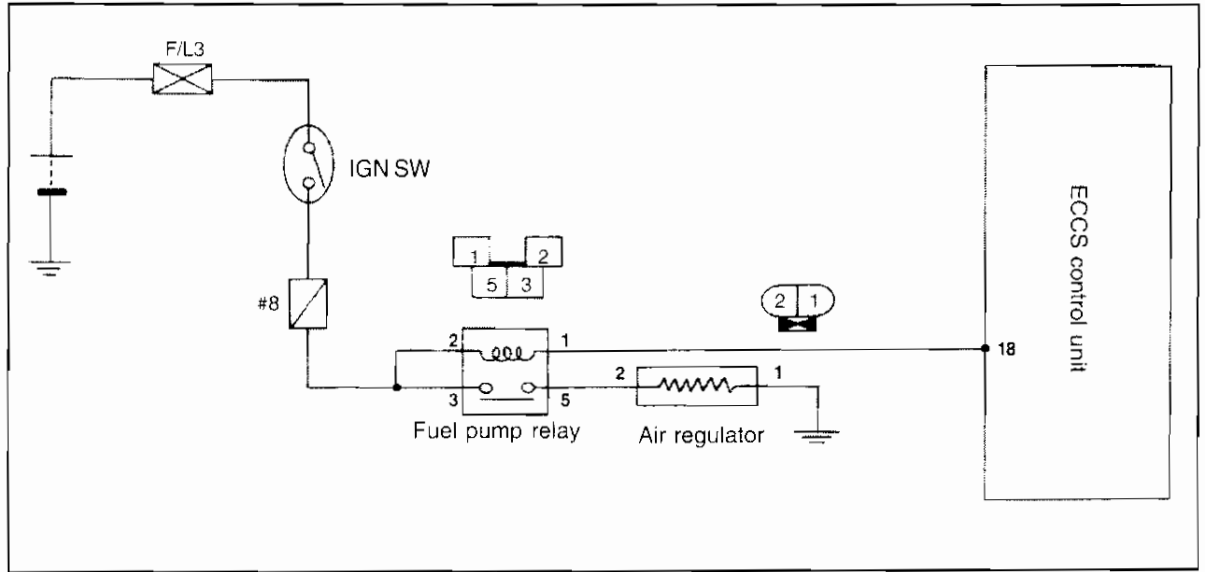

**Components location**

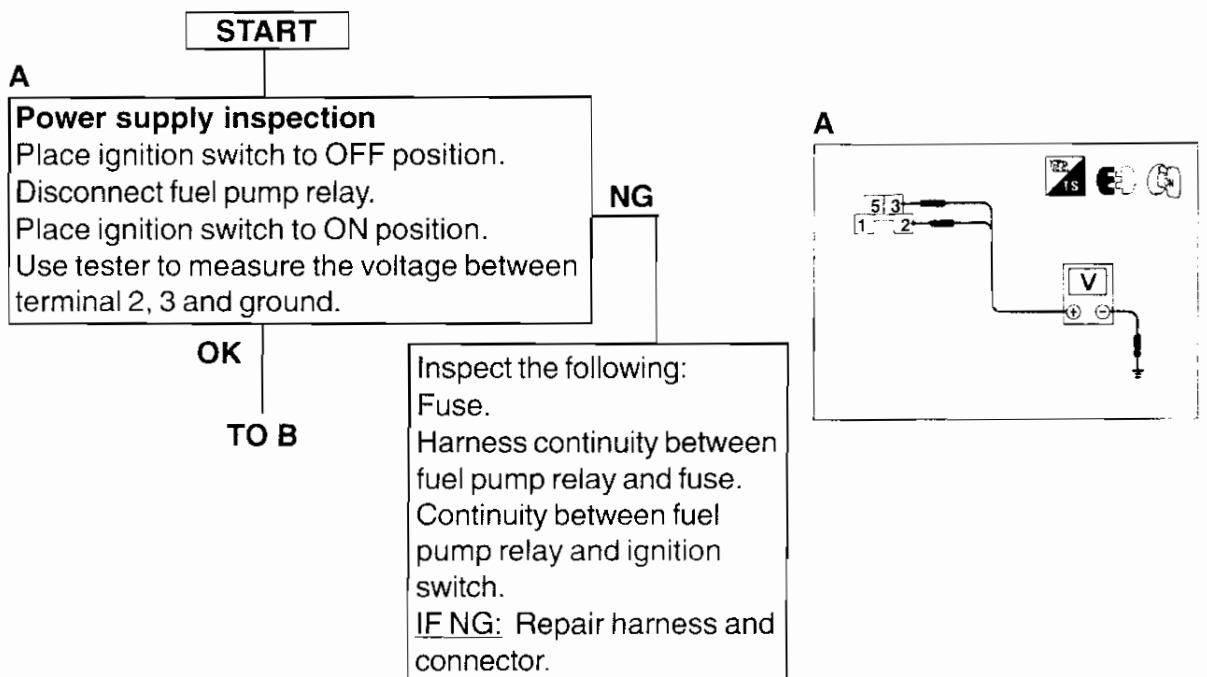
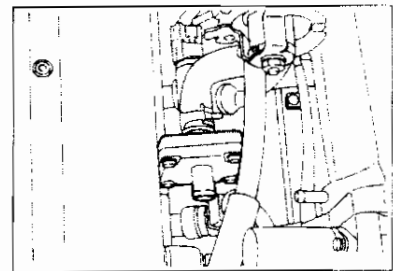
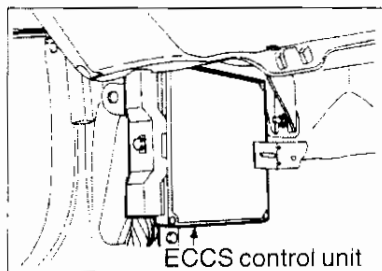

RB25DE ENGINE

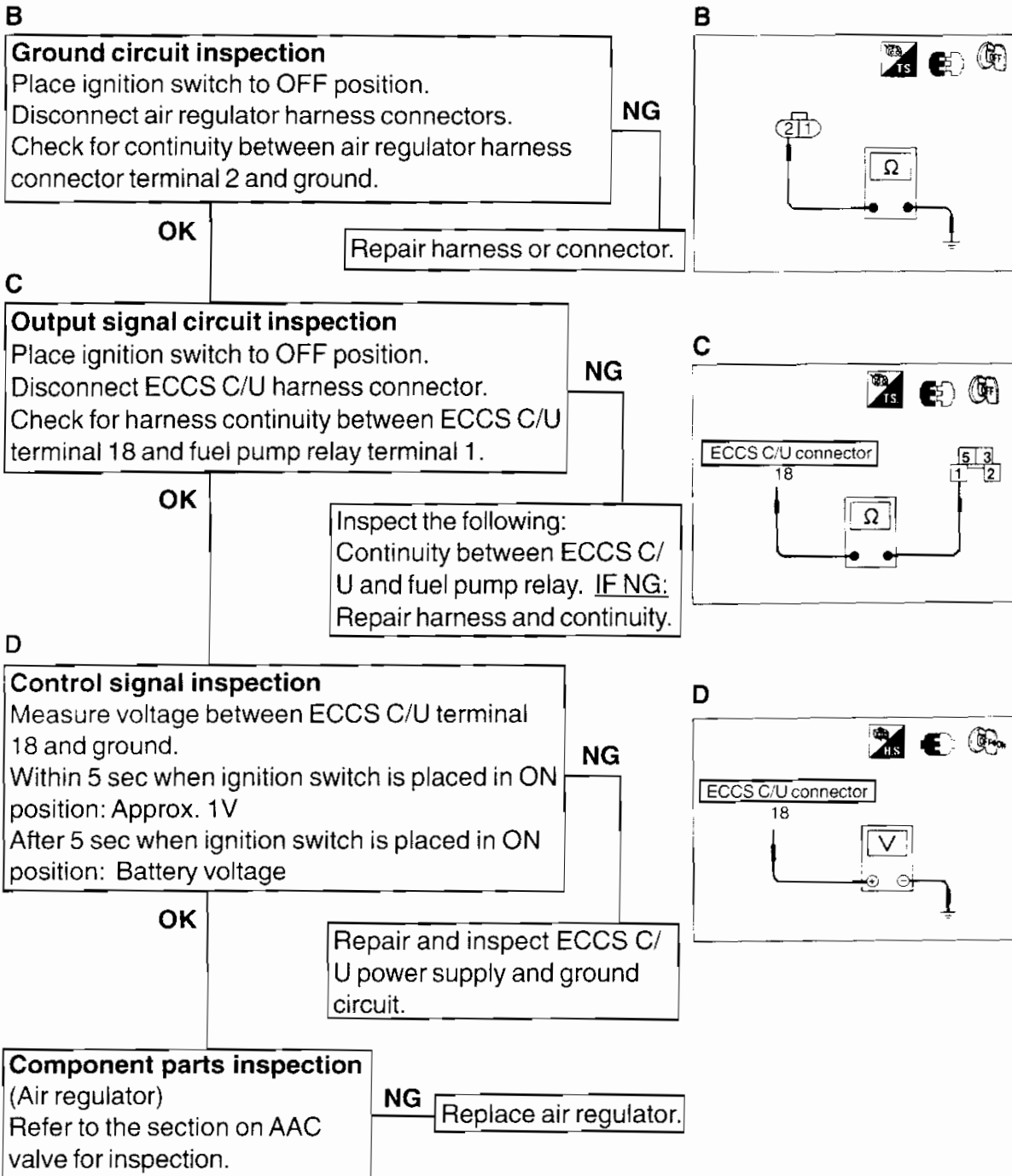

Carry out the inspection in the following order after repairs.

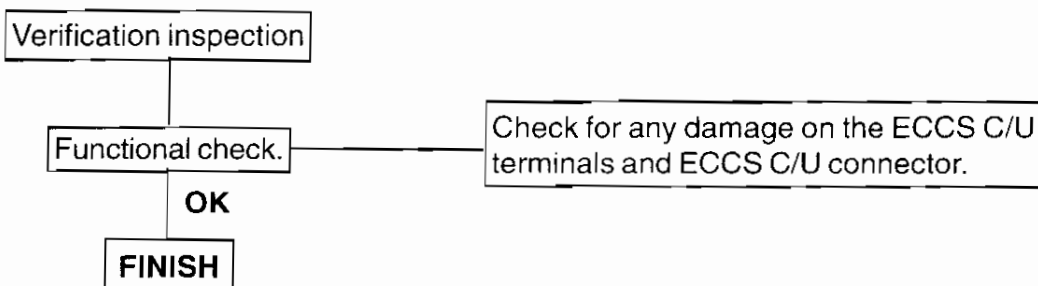



**DIAGNOSIS 21 - POWER STEERING HYDRAULIC PRESSURE SWITCH**

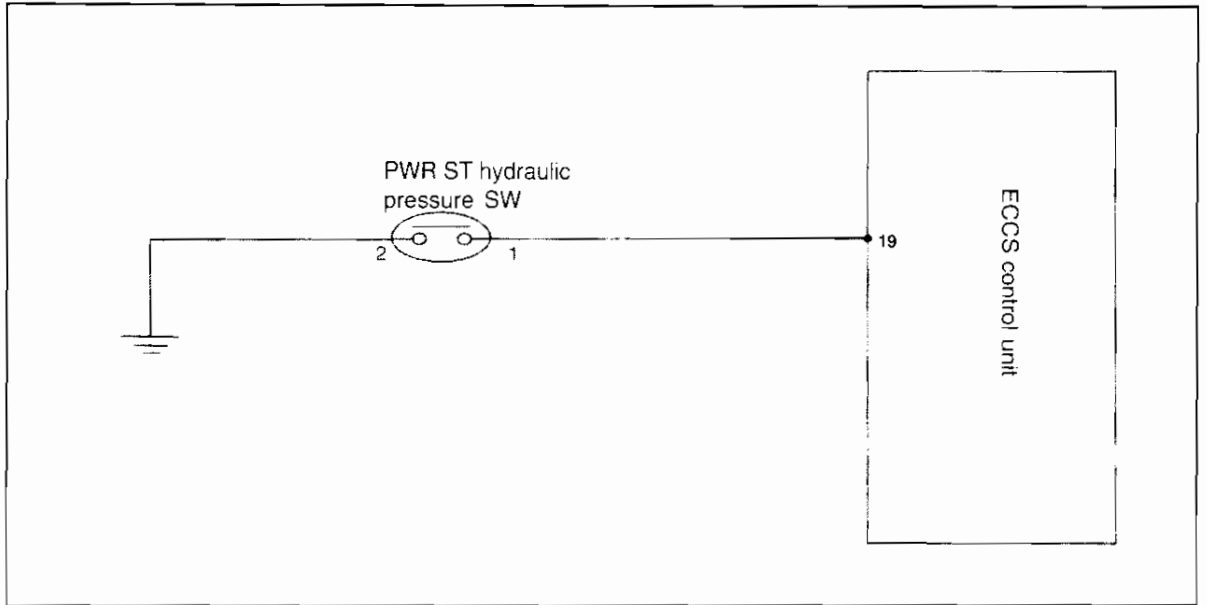

**Components location**

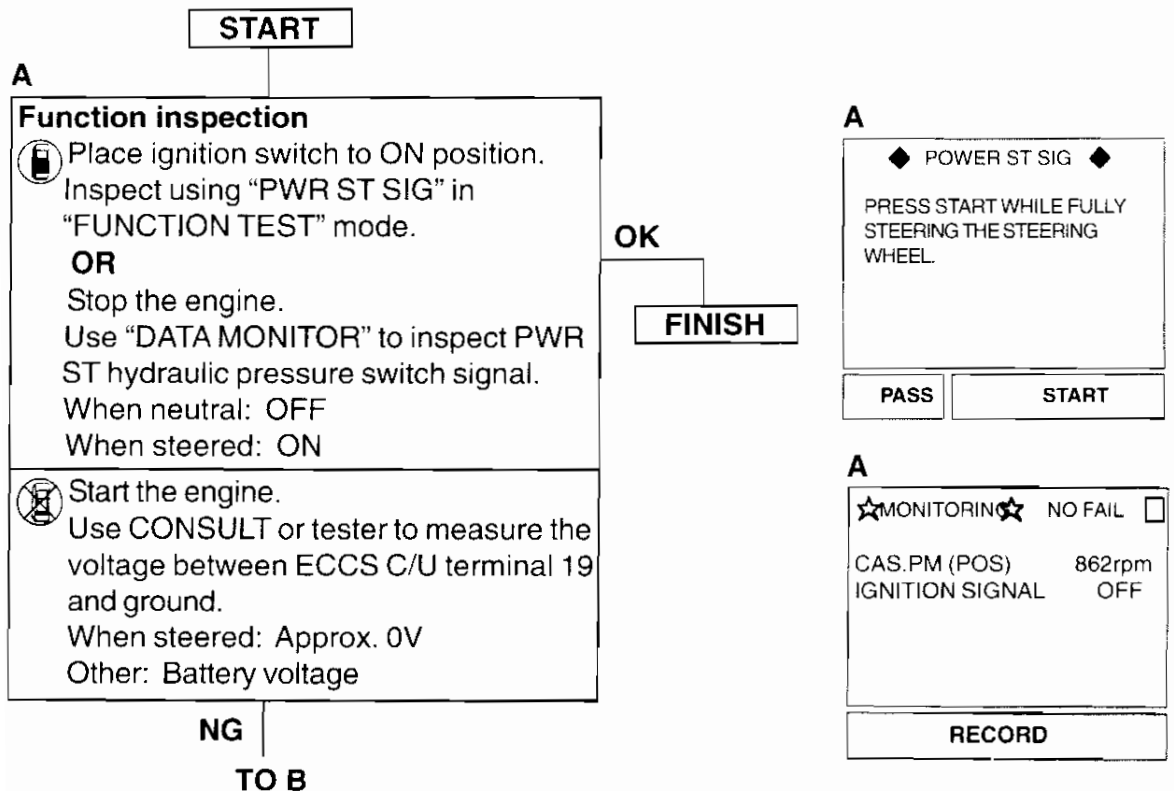
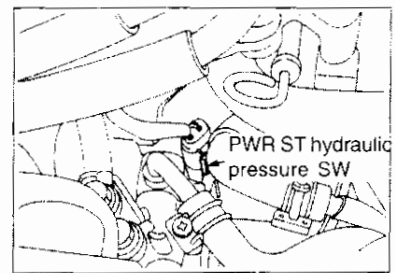
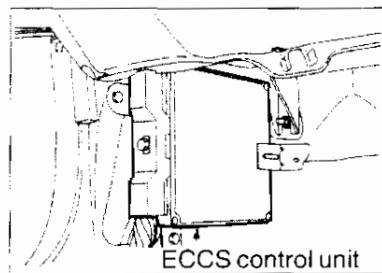

**B**

**Input signal circuit inspection**  
 Place ignition switch to OFF position.  
 Disconnect ECCS C/U harness connector.  
 Disconnect power steering hydraulic pressure switch harness connector.  
 Check for harness continuity between ECCS C/U terminal 19 and power steering hydraulic pressure switch terminal 1.

NG

OK

Repair harness or connector.

**C**

**Ground circuit inspection**  
 Check for continuity between power steering hydraulic pressure switch terminal 2 and engine ground.

NG

OK

Repair harness or connector.

**Component parts inspection**  
 (Power steering hydraulic pressure switch)  
 Refer to the section on power steering hydraulic pressure switch for inspection.

NG

Replace power steering hydraulic pressure switch.

Check for any damage on the ECCS C/U terminals and ECCS C/U connector.

**A**

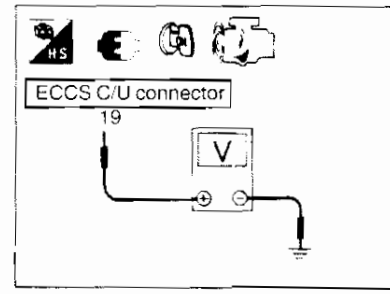

**B**

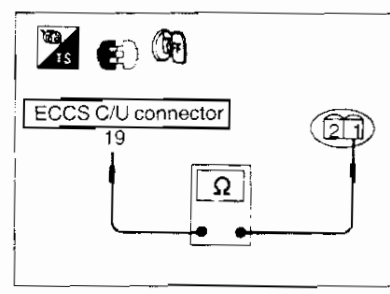

**C**

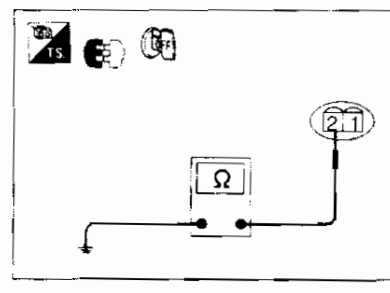

Carry out the inspection in the following order after repairs.

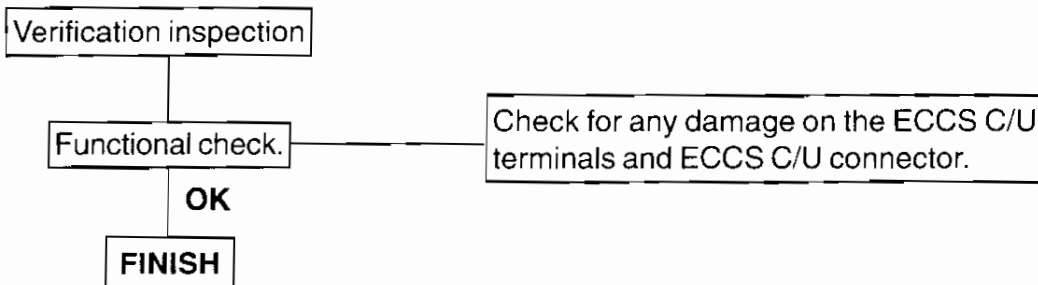

**DIAGNOSIS 22 (Phenomenon) - IDLE REV IS TOO HIGH (AFTER WARM UP)**

1

**Throttle sensor & air regulator inspection**

- Inspect in function test mode.
- Check if the throttle sensor (idle judgement) is not turned OFF.
- Make sure the air regulator unit is not locked or electricity is conducted to air regulator.

NG

OK

Circuit and throttle sensor inspection.  
Air regulator and circuit inspection.

2

**Intake air leak inspection**

- Warm up the engine.
- Change off set value by selecting "DWN" in "FUEL INJECTION RATIO OFF SET VALUE" in active test mode.
- Caution: Carry out the test in minimum time required. Do not operate during drive. Warm up the engine.
- Separate air flow meter harness connector.
- Check if the idle rev will decrease after racing the engine at approx. below 2000rpm for 30 seconds.

YES

NO

Repair where air is leaking.

3

**Throttle linkage inspection**

- Stop the engine.
- Check if the throttle linkage will move smoothly.
- Check if the throttle valve will close / open fully.

NG

OK

Repair throttle linkage or inspect throttle valve.

**FINISH**

1

◆ THROTTLE SENSOR ◆

PRESS START WHILE FULLY OPENING THE ACCELERATOR PEDAL.

PASS START

1

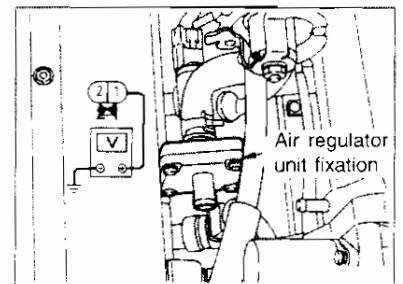

2

◆ ACTIVE TEST ◆

FUEL INJECTION OFF SET 0% MONITOR

CAS.RPM(POS)	937rpm
ENG TEMP SEN	59°C
O <sub>2</sub> SENSOR	1.33V
O <sub>2</sub> SENSOR (R)	1.35V
INJ PULSE	1.8msec
AAC VALVE	17°

Qu UP DWN Qd

2

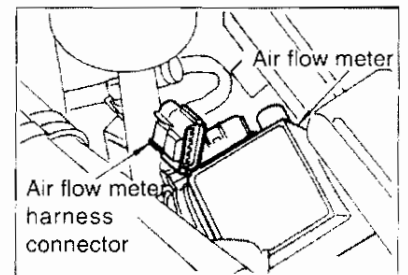

3

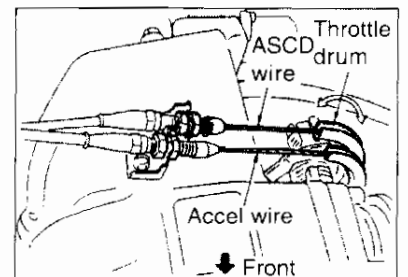

**DIAGNOSIS 23 (Phenomenon) - HUNTING**

**1**  
**Throttle sensor inspection**  
 Warm up the engine.  
 Check for any change with hunting when O<sub>2</sub> sensor connector is separated.

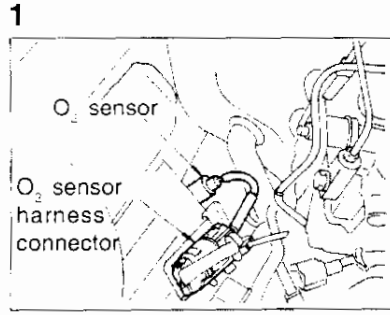

**YES**  
 O<sub>2</sub> sensor inspection

**2**  
**Power balance test**  
 Start the engine.  
 Use "POWER BALANCE" in function test.  
**Caution:** Carry out the test in minimum time required. Do not operate during drive.  
 Idle rev will decrease for a moment for each cylinder.  
 Idle rev will decrease for a moment when each cylinder injector connector is separated.

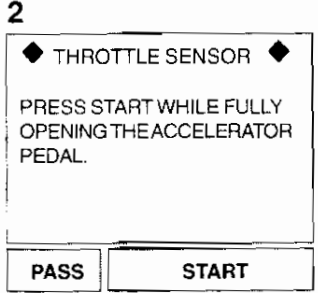

**NO**  
 To No.4

**3**  
**Spark plug inspection**  
 Stop the engine.  
 Disconnect spark plug and check for dirt, damage, gap etc.

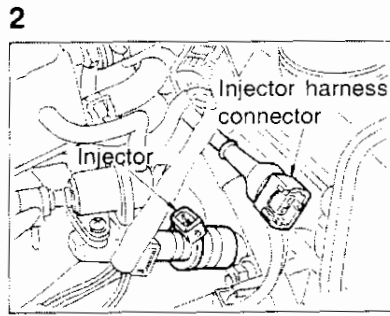

**OK**  
 Repair or replace.

**4**  
**Intake air leak inspection**  
 Start the engine.  
 Check if engine rev will increase when blow-by hose is pinched.

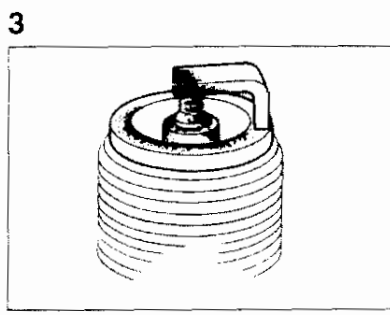

**NG**  
 Repair the leak

**NO**  
**FINISH**

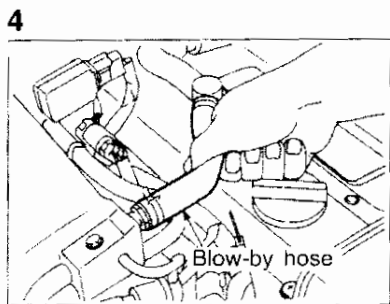

**DIAGNOSIS 24 (Phenomenon) - IDLE INSTABILITY**

1

**Operate power balance test**  
 Start the engine.  
 Operate "POWER BALANCE TEST" in function test. Caution: Operate the test in minimum time required. Do not operate during drive.  
 Idle rev will decrease for a moment when operating each pipes.

NO

YES

To No. 6

1

◆ POWER BALANCE ◆  
 INSPECT BALANCE OF EACH PIPES BY STOPPING INJECTOR OPERATION AT EACH PIPES.  
 TURN OFF ALL A/C AND LIGHTS

PASS      START

2

**Injector inspection**  
 Stop the engine.  
 Remove crank angle sensor.  
 (leave harness connector as it is).  
 Disconnect power transistor connector.  
 Place ignition switch from OFF to ON position.  
 Can you hear operation noise from each injector when the crank angle sensor shaft is rotated by hand.  
Warning: Depending on how the shaft is rotated, self-diagnosis will display abnormal, disregard this display.

NO

YES

Inspect injector and circuit

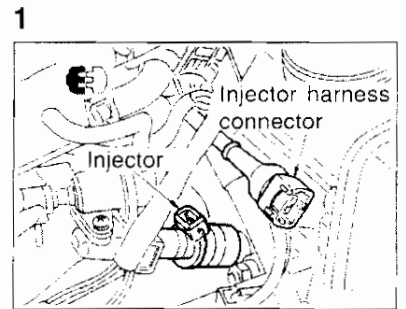

2

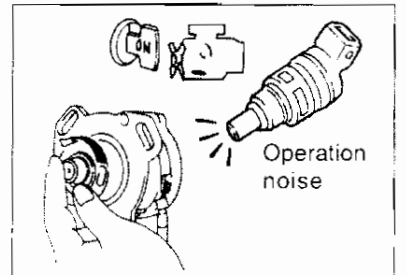

3

**Ignition inspection**  
 Place ignition switch to OFF position.  
 Remove ignition coil ASSY.  
 Install normal spark plug.  
 Face the spark plug rear end towards adequate ground such as collector and crank the engine.  
 Check the spark.

NG

OK

Inspect ignition coil, power transistor and circuits.

3

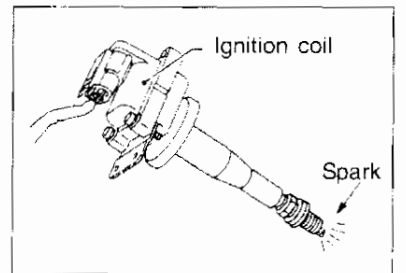

4

**Spark plug inspection**  
 Check for dirt, damage, gap etc. on the spark plug removed from the engine.

TO 5

4

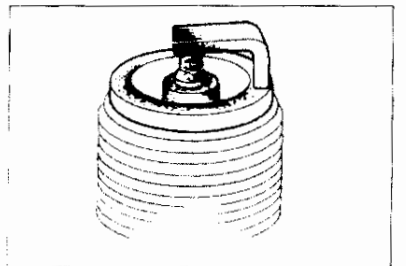

5

**Fuel pressure inspection**

 Start the engine.  
 Select "STOP" in "ACTIVE TEST" and bring fuel pressure to zero.  
 After engine stop, crank 2 ~ 3 times.  
 Inspect fuel pressure using fuel pressure gauge.  
 When idling: Approx. 2.5kg / cm<sup>2</sup>

 Start the engine.  
 Remove fuel pump fuse and bring fuel pressure to zero.  
 Attach fuel pressure gauge and inspect the pressure.

NG

OK

Inspect fuel pump and circuits.

5

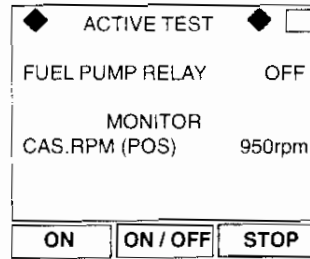

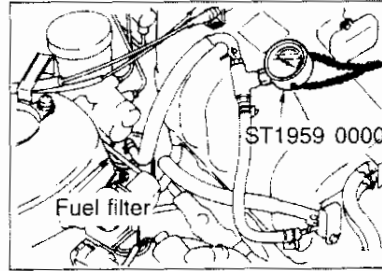

5



6

**Exhaust gas sensor inspection**

 Inspect using "BASE AIR-FUEL RATIO" in "FUNCTION TEST" mode.  
 Select "O<sub>2</sub> SENSOR MONITOR" in data monitor.  
 Set at 2000rpm with no load after warm up.  
 Check if the display "LEAN, RICH" will repeat for more than 5 times within 10 seconds.

 Operate vehicle side (within fuse box) diagnosis connector and change to "O<sub>2</sub> sensor monitor".  
 Set at 2000rpm with no load after warm up.  
 Check if the exhaust temperature warning lamp will flash for more than 5 times within 10 seconds.

NG

TO 7

Replace O<sub>2</sub> sensor

6

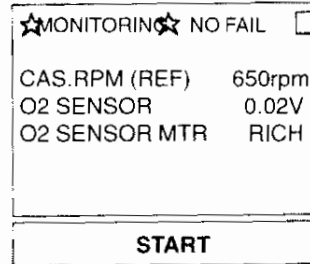

6

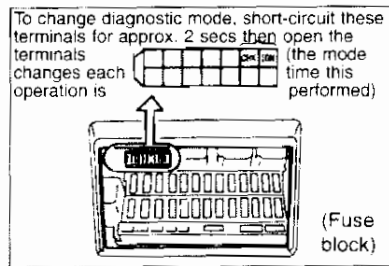

6

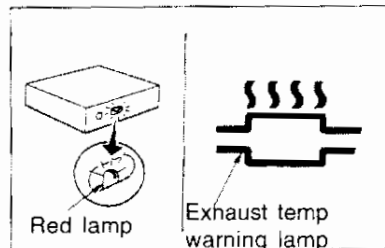

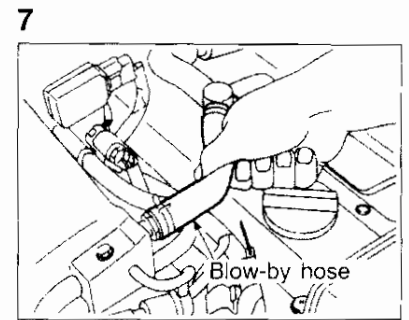
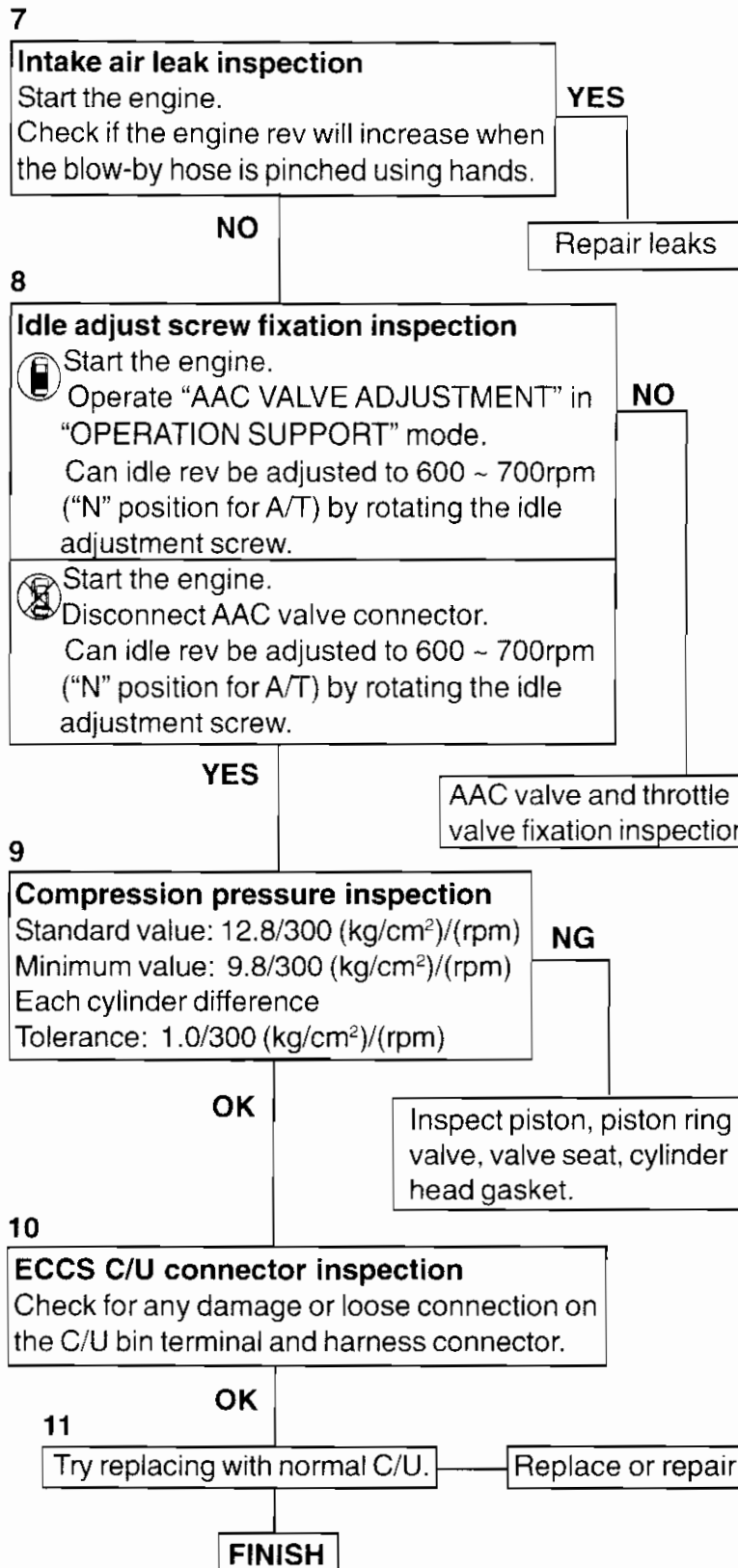

**8**

◆ AAC VALVE ADJ ◆  
 SET THE CAS.PRM TO STANDARD VALUE UNDER THE FOLLOWING CONDITION:  
 AFTER WARM UP.  
 TURN OFF ALL LIGHTS AND AIR CONDITIONER.

**START**

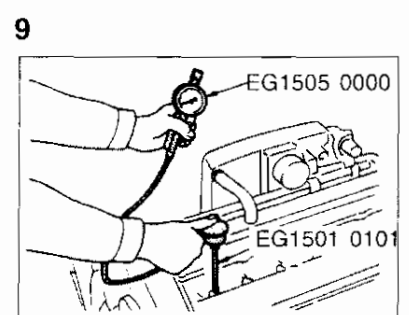
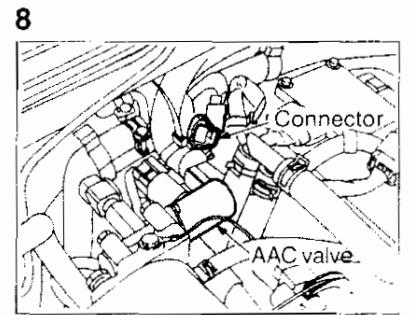

**DIAGNOSIS 25 (Phenomenon) - WHEN COLD, DIFFICULT TO START OR CAN NOT START THE ENGINE**

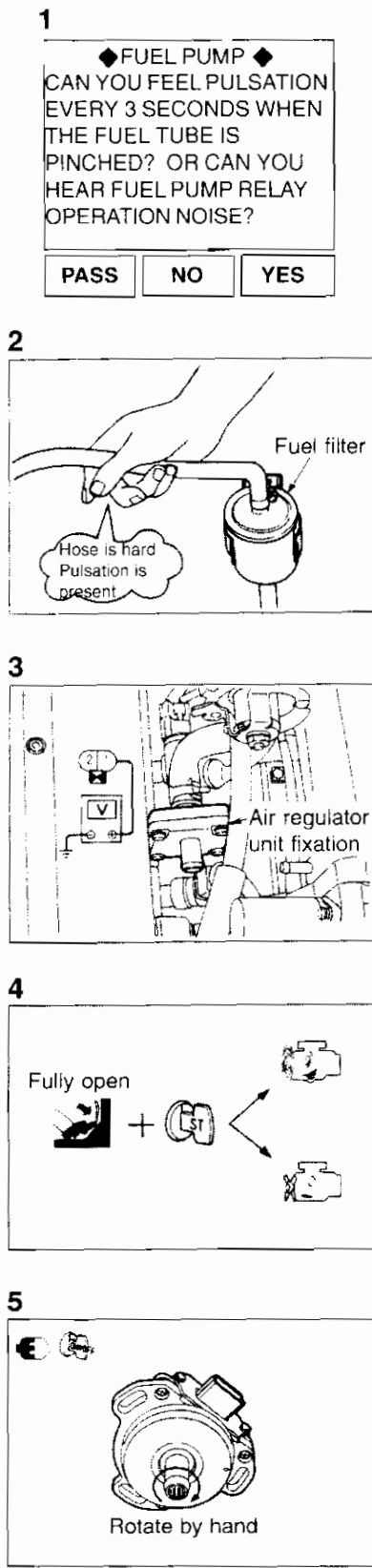
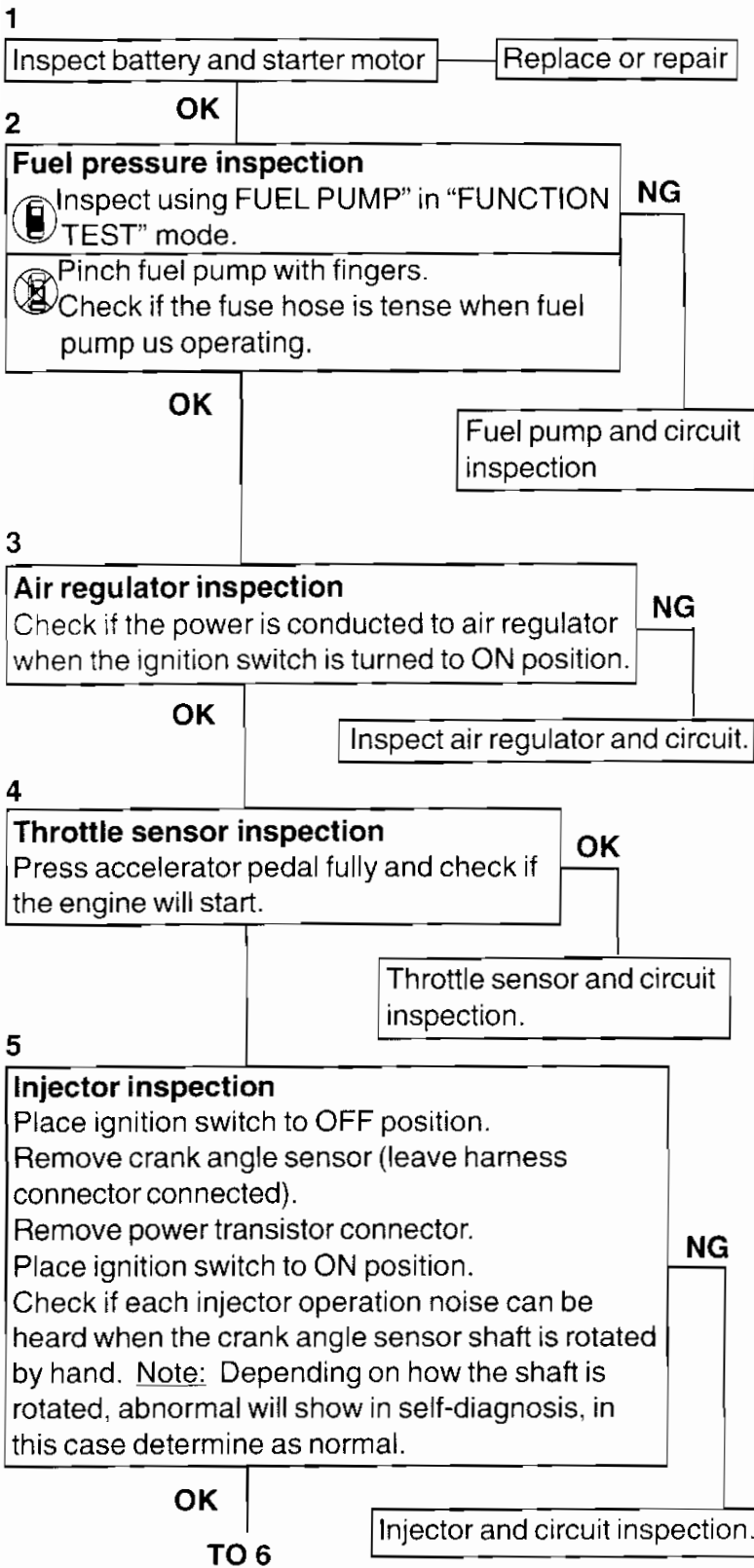



RB25DE ENGINE

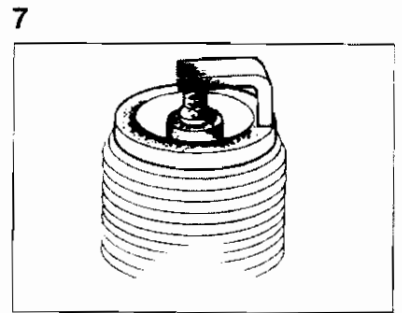
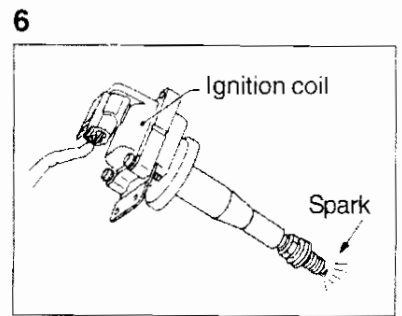
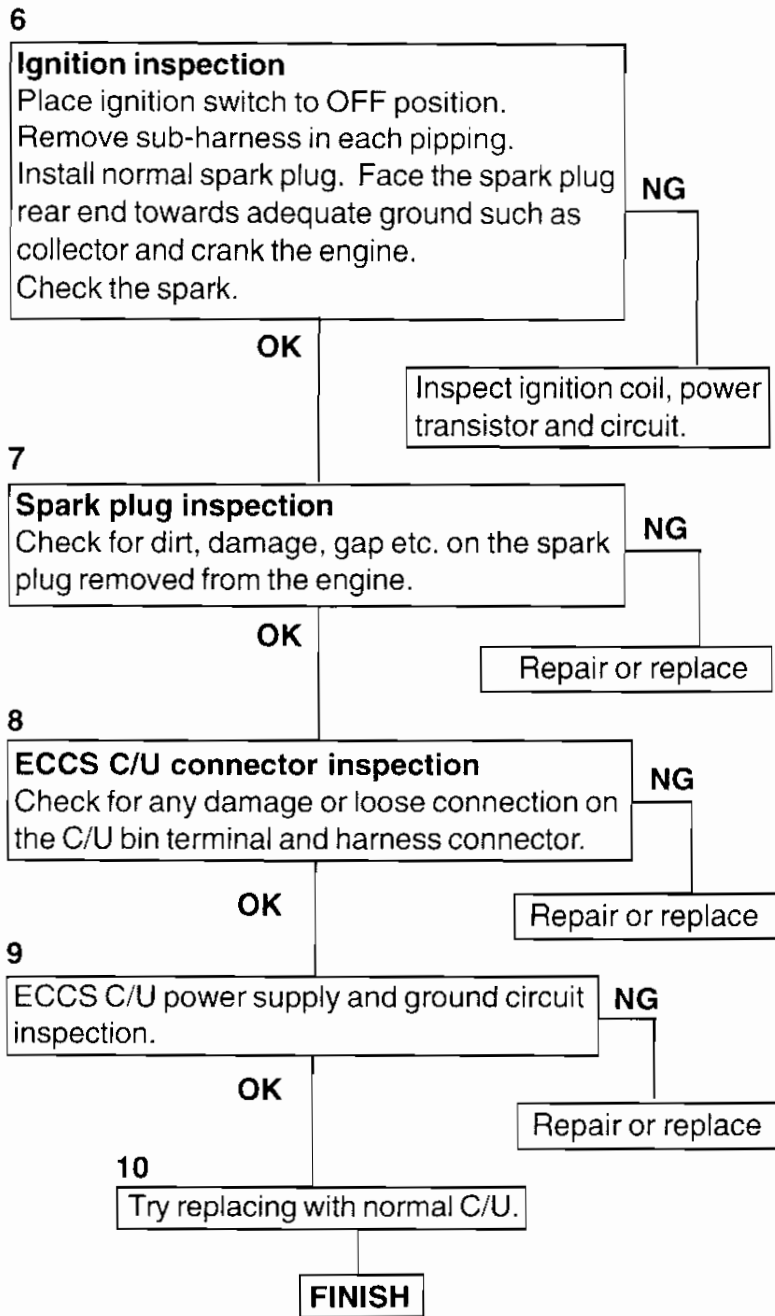

**DIAGNOSIS 26 (Phenomenon) - WHEN WARM, DIFFICULT TO START OR CAN NOT START THE ENGINE**

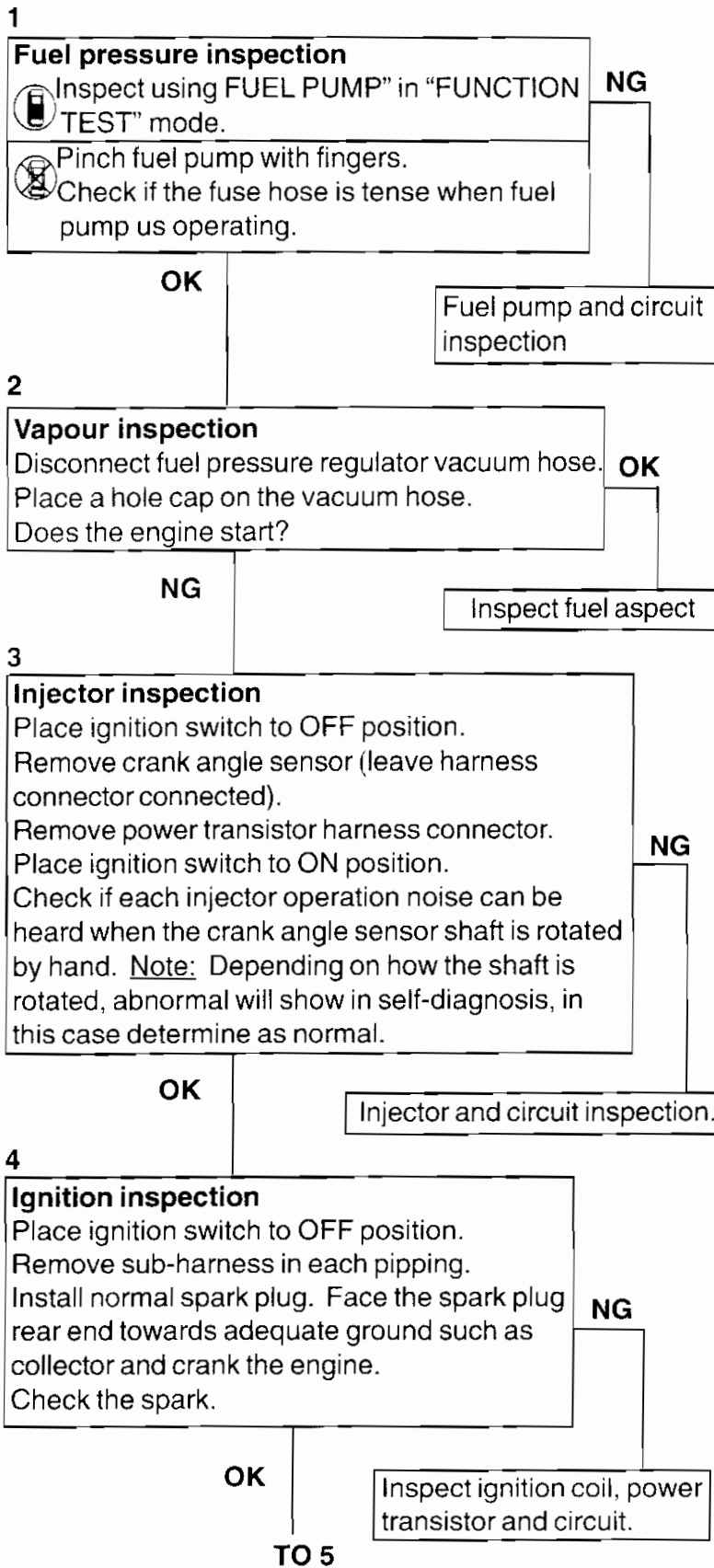

**1**

◆ FUEL PUMP ◆  
 CAN YOU FEEL PULSATION EVERY 3 SECONDS WHEN THE FUEL TUBE IS PINCHED? OR CAN YOU HEAR FUEL PUMP RELAY OPERATION NOISE?

PASS NO YES

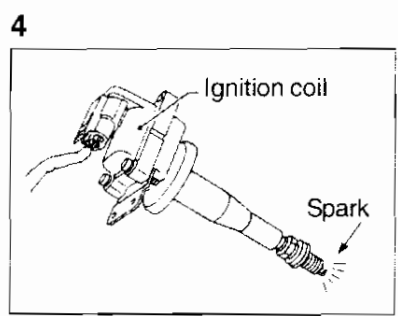
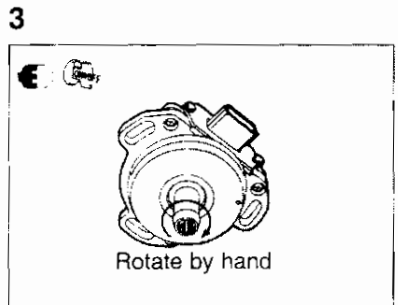
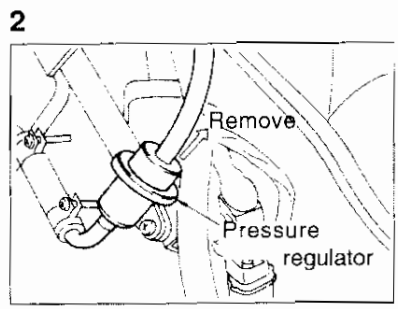
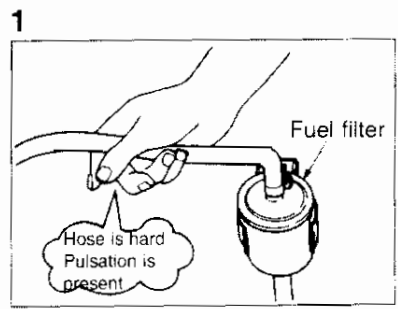

RB25DE ENGINE

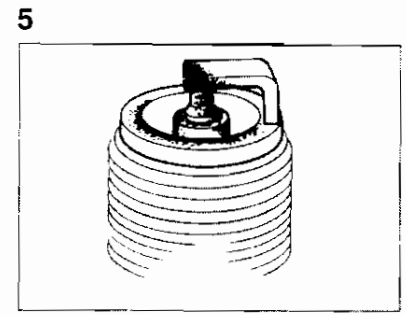
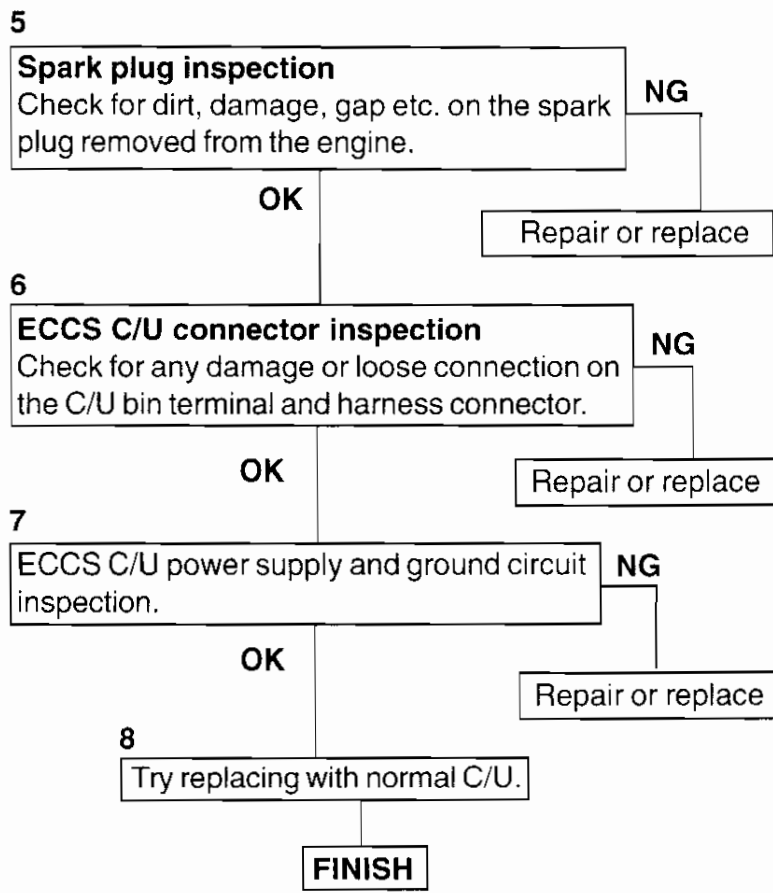

**DIAGNOSIS 27 (Phenomenon) - IN NORMAL CONDITION, DIFFICULT TO START OR CAN NOT START THE ENGINE**

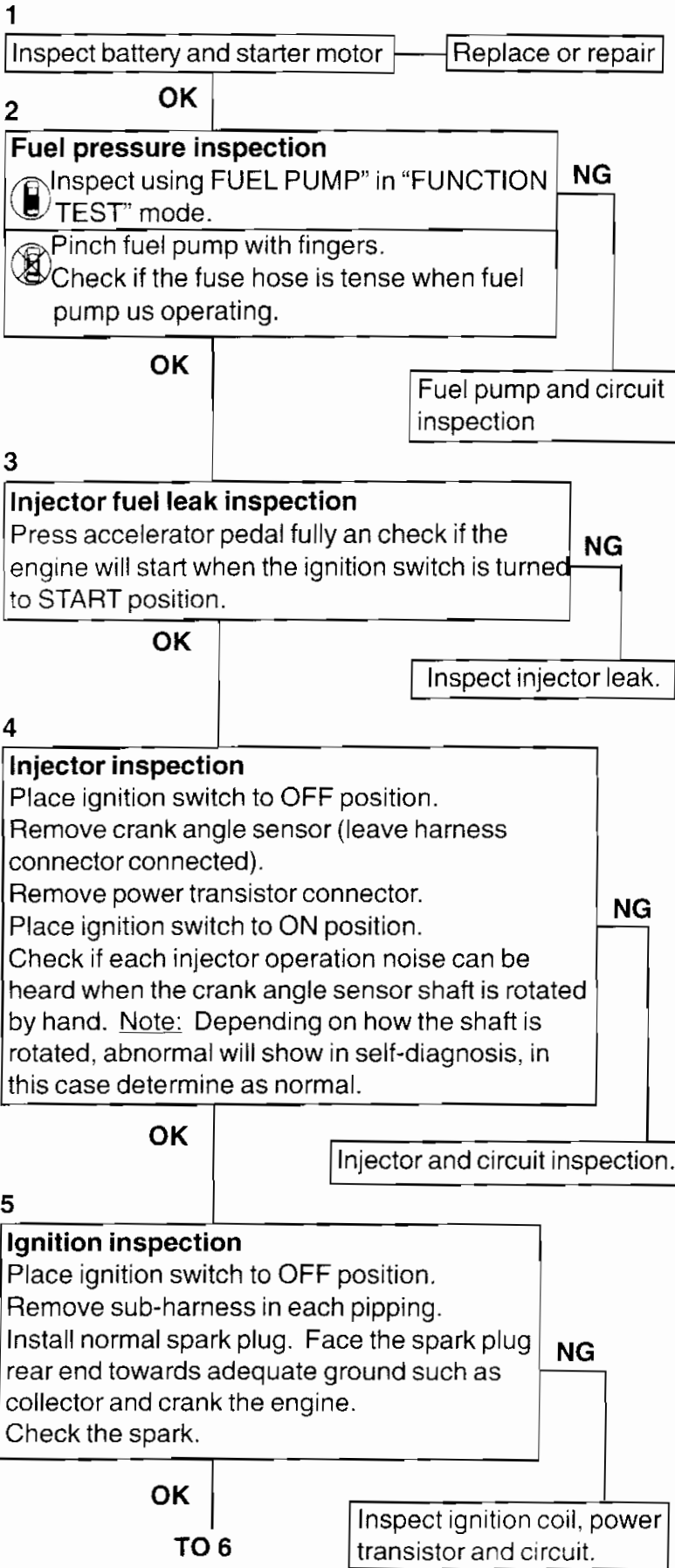

**1**

◆ FUEL PUMP ◆  
 CAN YOU FEEL PULSATION EVERY 3 SECONDS WHEN THE FUEL TUBE IS PINCHED? OR CAN YOU HEAR FUEL PUMP RELAY OPERATION NOISE?

PASS NO YES

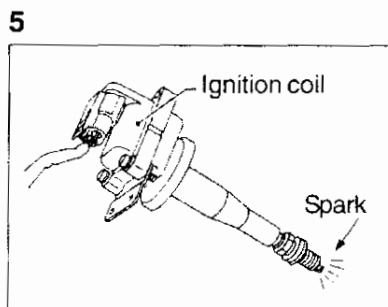
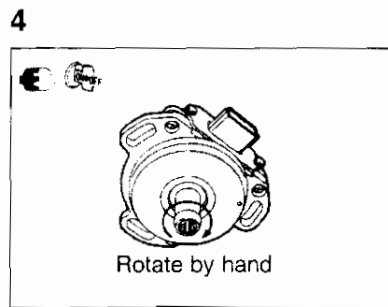
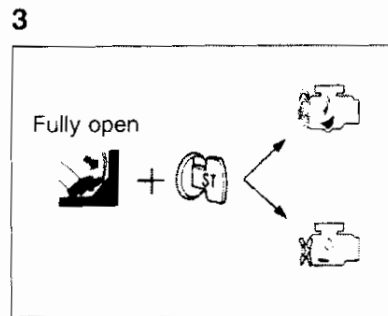
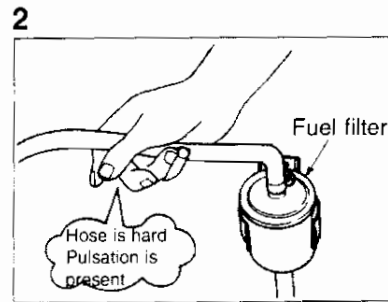

RB25DE ENGINE

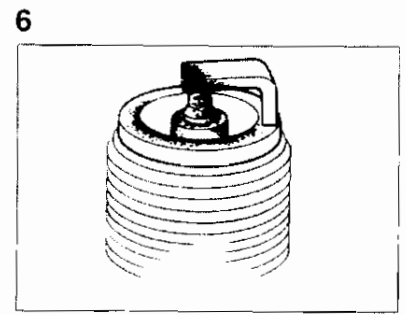
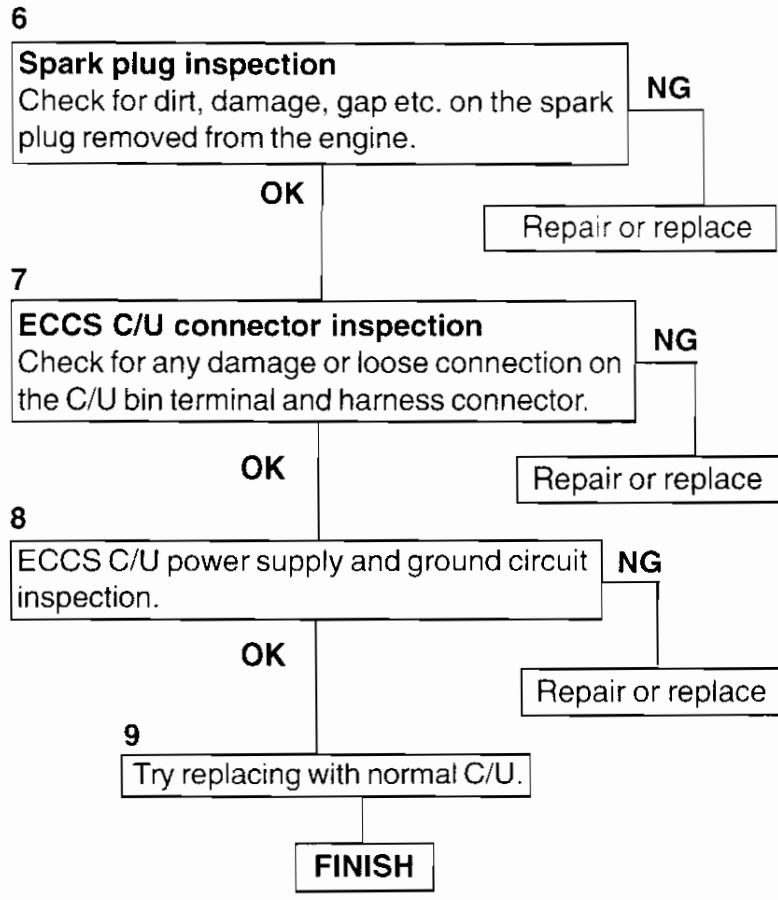

**DIAGNOSIS 28 (Phenomenon) - HESITATION AFTER WARM UP**  
(hesitation as throttle valve starts to open)

**1**

**Fuel pressure inspection**

Select "UP" or "DWN" in "FUEL INJECTION QUANTITY CORRECTION" in "ACTIVE TEST" mode to change correction value.  
Caution: Carry out the test in minimum time required. Do not operate during drive.

Disconnect fuel pressure regulator vacuum hose.  
Place hole cap on vacuum hose.  
Operate cruise test.  
Is there still hesitation?

**OK**

**NG**

**1**

◆ ACTIVE TEST ◆	◆	□
FUEL INJECTION OFF SET	0%	
MONITOR		
CAS.RPM(POS)	937rpm	
ENG TEMP SEN	59°C	
O <sub>2</sub> SENSOR	1.33V	
O <sub>2</sub> SENSOR (R)	1.35V	
INJ PULSE	1.8msec	
AAC VALVE	17%	
Qu	UP	DWN
		Qd

If lean hesitation inspect pressure regulator and fuel pump.

Fuel aspect inspection

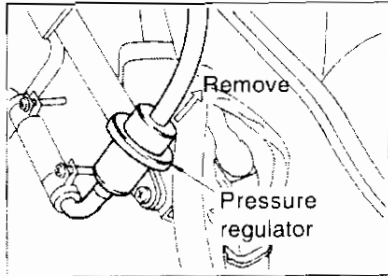

**2**

**Canister purge inspection**

Disconnect canister purge hose.  
Place hole cap on the purge hose.  
Conduct cruise test.  
Is there still hesitation?

**NG**

Inspect purge and vacuum system.

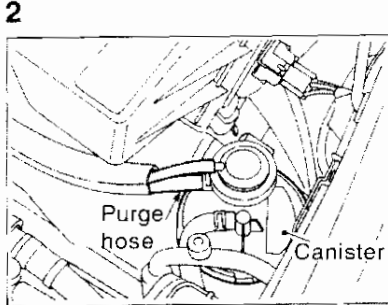

**FINISH**

**DIAGNOSIS 29 (Phenomenon) - HESITATION WHEN COLD**  
**(hesitation as throttle valve starts to open)**

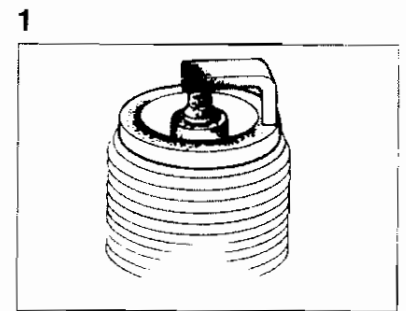
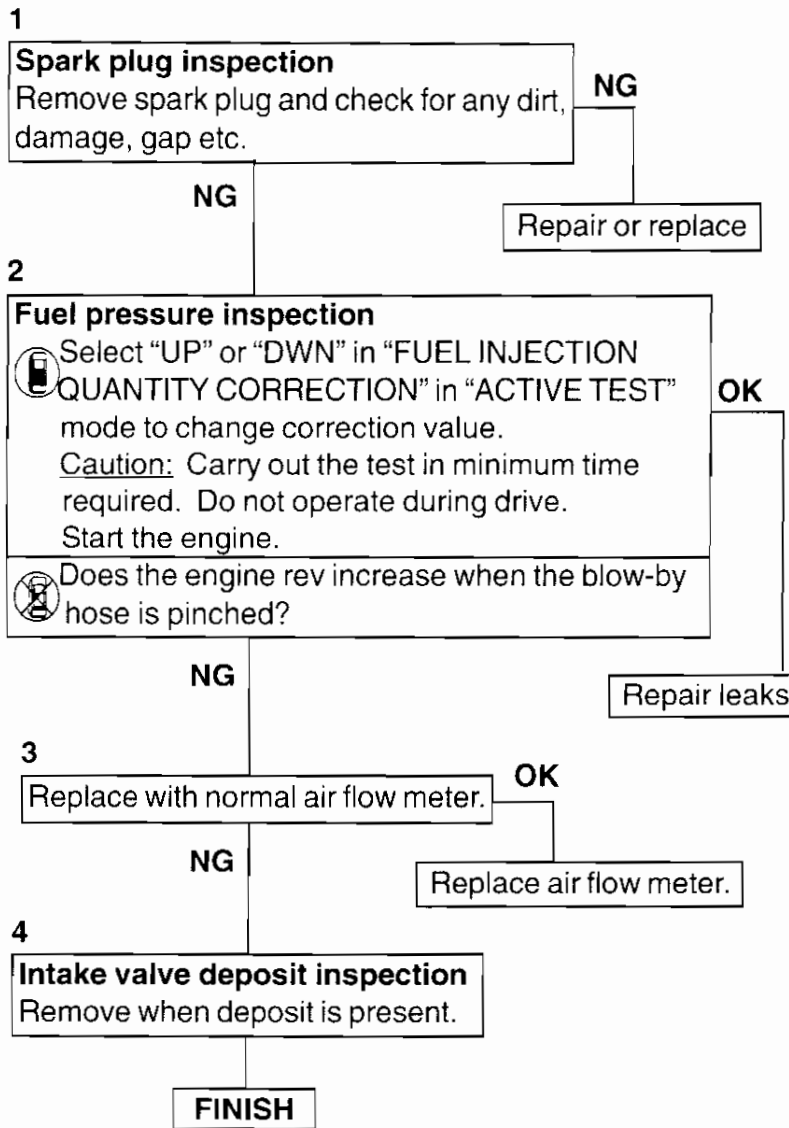

**2**

◆	ACTIVE TEST	◆	<input type="checkbox"/>
FUEL INJECTION OFF SET 0%			
MONITOR			
CAS.RPM(POS)	937rpm		
ENG TEMP SEN	59°C		
O <sub>2</sub> SENSOR	1.33V		
O <sub>2</sub> SENSOR (R)	1.35V		
INJ PULSE	1.8msec		
AAC VALVE	17%		
Qu	UP	DWN	Qd

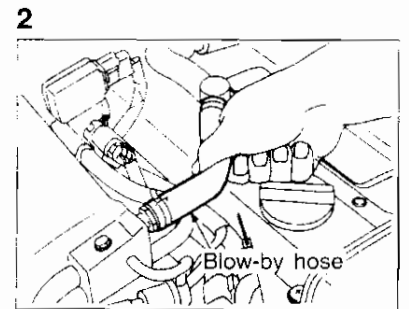

**DIAGNOSIS 30 (Phenomenon) - HESITATION IN NORMAL CONDITION**  
**(hesitation as throttle valve starts to open)**

**1**

**Spark plug inspection**  
 Remove spark plug and check for any dirt, damage, gap etc.

NG

NG

Repair or replace

**2**

**Exhaust gas sensor inspection**

Inspect using "BASE AIR-FUEL RATIO" in "FUNCTION TEST" mode.  
 Select "O<sub>2</sub> SENSOR MONITOR" in data monitor.  
 Set at 2000rpm with no load after warm up.  
 Check if the display "LEAN, RICH" will repeat for more than 5 times within 10 seconds.

Operate vehicle side (within fuse box) diagnosis connector and change to "O<sub>2</sub> sensor monitor".  
 Set at 2000rpm with no load after warm up.  
 Check if the exhaust temperature warning lamp will flash for more than 5 times within 10 seconds.

NG

Replace O<sub>2</sub> sensor

**3**

**Canister purge inspection**  
 Disconnect canister purge hose. Place hole cap on purge hose. Conduct cruise test. Is there still hesitation?

OK

Inspect purge and vacuum system

**4**

**Intake air leak inspection**

Warm up the engine.  
 Change off set value by selecting "DWN" in "FUEL INJECTION RATIO OFF SET VALUE" in active test mode.  
 Caution: Carry out the test in minimum time required. Do not operate during drive. Warm up the engine.

Separate air flow meter harness connector.  
 Check if the idle rev will decrease after racing the engine at approx. below 2000rpm for 30 seconds.

NG

Repair any leaks

**FINISH**

**2**

◆ BASE AIR FUEL RATIO TEST ◆

HOLD ENGINE REV 2000+/- 200rpm AND PRESS START.

1800 2000 2200

PASS START

**2**

To change diagnostic mode, short-circuit these terminals for approx. 2 secs then open the terminals changes each operation is (the mode time this performed)

(Fuse block)

**2**

Red lamp

Exhaust temp warning lamp

**3**

Purge hose

Canister

**4**

◆ ACTIVE TEST ◆

FUEL INJECTION OFF SET 0% MONITOR

CAS.RPM(POS)	937rpm
ENG TEMP SEN	59°C
O <sub>2</sub> SENSOR	1.33V
O <sub>2</sub> SENSOR (R)	1.35V
INJ PULSE	1.8msec
AAC VALVE	17%

Qu UP DWN Qd

**4**

Blow-by hose



**DIAGNOSIS 31 (Phenomenon) - ENGINE STALL WHILE REVVING**

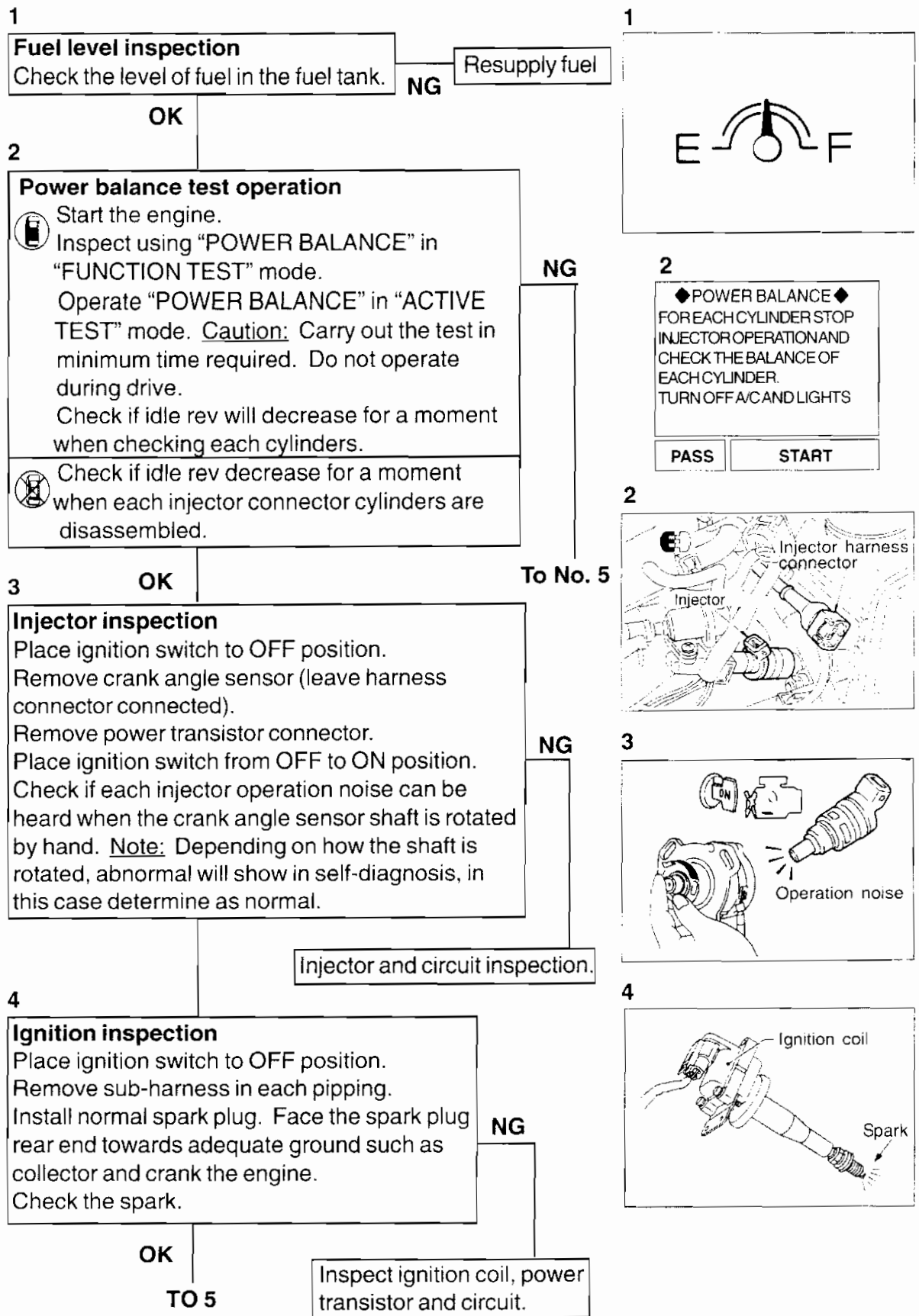

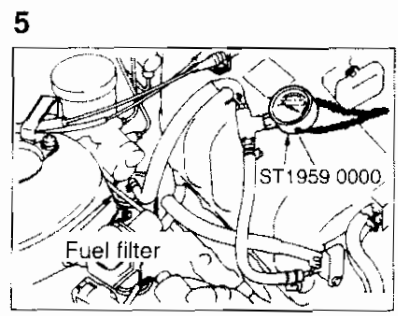
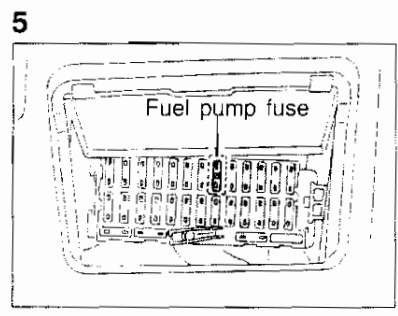
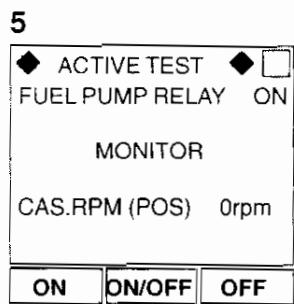
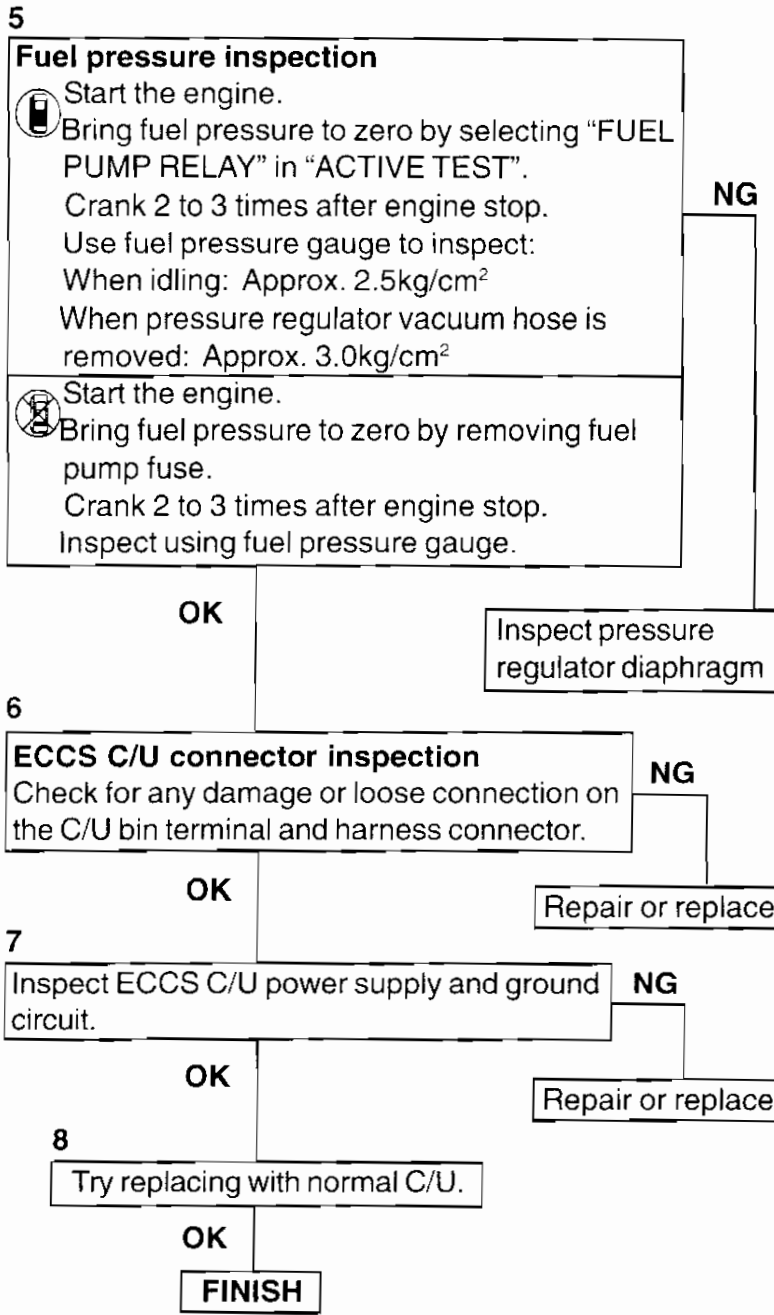

**DIAGNOSIS 32 (Phenomenon) - ENGINE STALL AFTER WARM UP**

**1**

**Vapour inspection**

Change correction value by selecting "DWN" in "FUEL INJECTION CORRECTION" in "ACTIVE TEST" mode.

**Caution:** Carry out the test in minimum time required. Do not operate during drive.

Disconnect pressure regulator vacuum.  
Place hole cap on vacuum hose.  
Operate cruise test.  
Does the engine still stall?

**1**

◆ ACTIVE TEST ◆	<input type="checkbox"/>
FUEL INJECTION OFF SET	0%
MONITOR	
CAS.RPM(POS)	937rpm
ENG TEMP SEN	59°C
O <sub>2</sub> SENSOR	1.33V
O <sub>2</sub> SENSOR (R)	1.35V
INJ PULSE	1.8msec
AAC VALVE	17%

Qu UP DWN Qd

**2 NG**

**Power balance test operation**

Start the engine.  
Inspect using "POWER BALANCE" in "FUNCTION TEST" mode.  
Operate "POWER BALANCE" in "ACTIVE TEST" mode. **Caution:** Carry out the test in minimum time required. Do not operate during drive.  
Check if idle rev will decrease for a moment when checking each pipping.

Check if idle rev decrease for a moment when each injector connector pipping are disassembled.

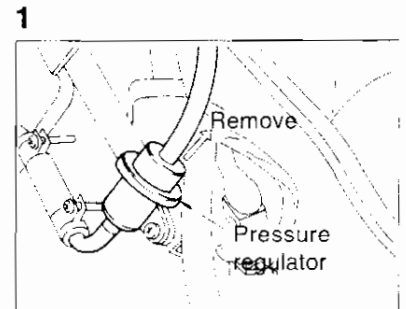

**2**

◆ POWER BALANCE ◆  
FOR EACH CYLINDER STOP INJECTOR OPERATION AND CHECK THE BALANCE OF EACH CYLINDER.  
TURN OFF A/C AND LIGHTS

PASS START

**3 OK**

**Injector inspection**

Place ignition switch to OFF position.  
Remove crank angle sensor (leave harness connector connected).  
Remove power transistor connector.  
Place ignition switch from OFF to ON position.  
Check if each injector operation noise can be heard when the crank angle sensor shaft is rotated by hand. **Note:** Depending on how the shaft is rotated, abnormal will show in self-diagnosis, in this case determine as normal.

To No. 5

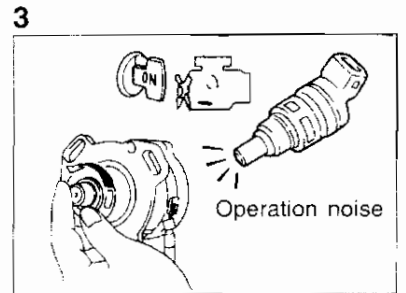
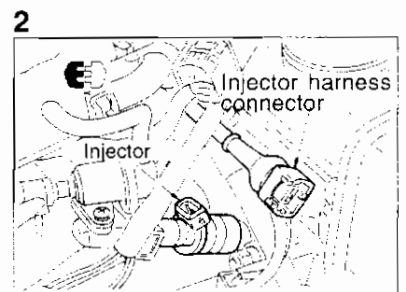

Injector and circuit inspection.

**4**

**Ignition inspection**

Place ignition switch to OFF position.  
Remove sub-harness in each pipping.  
Install normal spark plug. Face the spark plug rear end towards adequate ground such as collector and crank the engine.  
Check the spark.

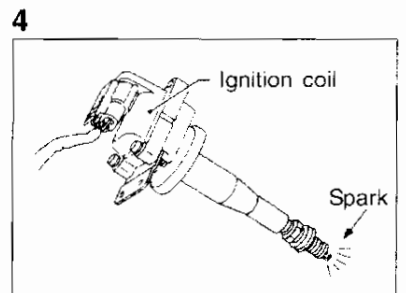

5

**Fuel pressure inspection**

 Start the engine.  
 Bring fuel pressure to zero by selecting "FUEL PUMP RELAY" in "ACTIVE TEST" mode.  
 Crank 2 to 3 times after engine stop.  
 Use fuel pressure gauge to inspect:  
 When idling: Approx. 2.5kg/cm<sup>2</sup>  
 When pressure regulator vacuum hose is removed: Approx. 3.0kg/cm<sup>2</sup>

 Start the engine.  
 Bring fuel pressure to zero by removing fuel pump fuse.  
 Crank 2 to 3 times after engine stop.  
 Inspect using fuel pressure gauge.

NG

OK

Inspect pressure regulator diaphragm

5

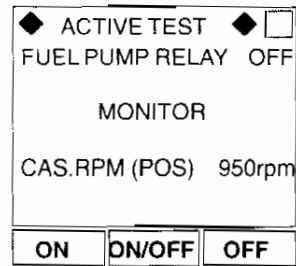

5

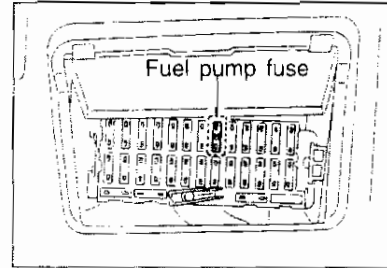

5

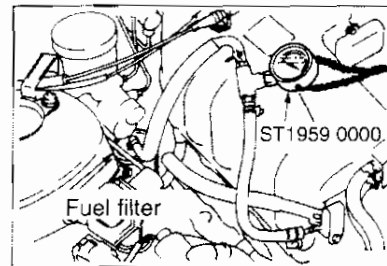

6

**ECCS C/U connector inspection**

Check for any damage or loose connection on the C/U bin terminal and harness connector.

NG

OK

Repair or replace

7

Inspect ECCS C/U power supply and ground circuit.

NG

OK

Repair or replace

8

Try replcing with normal C/U.

OK

FINISH

**DIAGNOSIS 33 (Phenomenon) - ENGINE STALL WHEN COLD**

1

**Air regulator inspection**  
Check if the power is conducted to air regulator when ignition switch is in ON position.

NG

OK

Inspect air regulator and circuit.

1

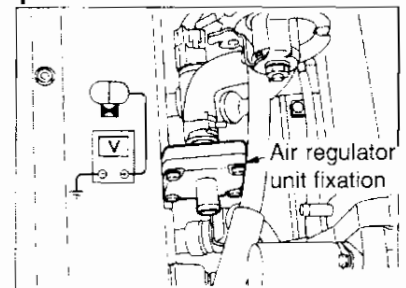

2

**Throttle sensor inspection**  
Press accelerator pedal fully and check if the engine can be started when the engine is cold.

NG

Inspect air regulator and circuit.

2

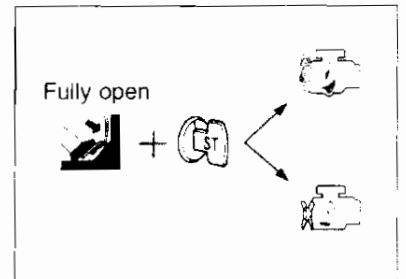

3

**Power balance test operation**

- Start the engine. Inspect using "POWER BALANCE" in "FUNCTION TEST" mode. Operate "POWER BALANCE" in "ACTIVE TEST" mode. Caution: Carry out the test in minimum time required. Do not operate during drive. Check if idle rev will decrease for a moment when checking each cylinders.
- Check if idle rev decrease for a moment when each injector connector cylinders are disassembled.

NG

3

◆ POWER BALANCE ◆  
FOR EACH CYLINDER STOP INJECTOR OPERATION AND CHECK THE BALANCE OF EACH CYLINDER. TURN OFF A/C AND LIGHTS

PASS      START

4

OK

**Injector inspection**  
Place ignition switch to OFF position. Remove crank angle sensor (leave harness connector connected). Remove power transistor connector. Place ignition switch from OFF to ON position. Check if each injector operation noise can be heard when the crank angle sensor shaft is rotated by hand. Note: Depending on how the shaft is rotated, abnormal will show in self-diagnosis, in this case determine as normal.

To No. 7

3

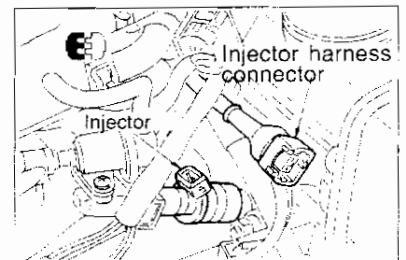

NG

4

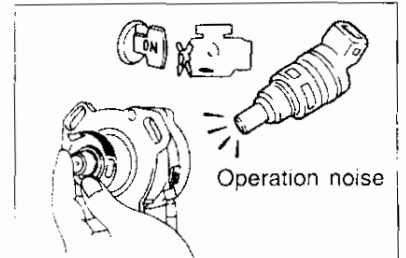

Injector and circuit inspection.

TO 5

5

**Ignition inspection**  
Place ignition switch to OFF position.  
Remove sub-harness in each cylinders.  
Install normal spark plug. Face the spark plug rear end towards adequate ground such as collector and crank the engine.  
Check the spark.

NG

OK

Inspect ignition coil, power transistor and circuit.

5

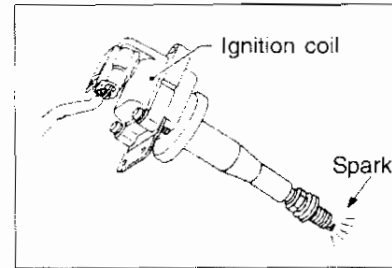

6

**Spark plug inspection**  
Check for dirt, damage, gap etc. on the spark plug removed from the engine.

NG

Repair or replace

6

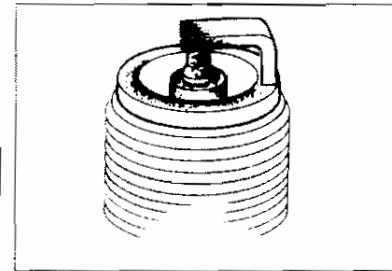

7

OK

**Fuel pressure inspection**  
Start the engine.  
Bring fuel pressure to zero by selecting "FUEL PUMP RELAY" in "ACTIVE TEST" mode.  
Crank 2 to 3 times after engine stop.  
Use fuel pressure gauge to inspect:  
When idling: Approx. 2.5kg/cm<sup>2</sup>  
When pressure regulator vacuum hose is removed: Approx. 3.0kg/cm<sup>2</sup>

NG

Start the engine.  
Bring fuel pressure to zero by removing fuel pump fuse.  
Crank 2 to 3 times after engine stop.  
Inspect using fuel pressure gauge.

OK

Inspect pressure regulator diaphragm

7

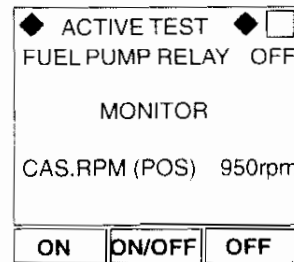

7

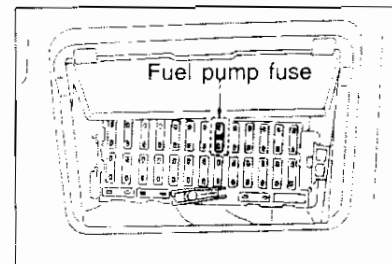

8

**ECCS C/U connector inspection**  
Check for any damage or loose connection on the C/U bin terminal and harness connector.

NG

OK

Repair or replace

9

Inspect ECCS C/U power supply and ground circuit.

NG

OK

Repair or replace

10

Try replacing with normal C/U.

OK

FINISH

**DIAGNOSIS 34 (Phenomenon) - ENGINE STALL WHEN ACCELERATING INSTANTLY**

**1 AAC valve inspection**

Warm engine.  
Inspect using "AAC VALVE" in "FUNCTION TEST" OR  
Select "AAC VALVE ADJ" in "ACTIVE TEST".  
Check if the engine rev will change when "Qu" or "Qd" is selected to change AAC valve opening.

Start the engine.  
 Check if engine rev will decrease when AAC valve connector is disconnected.

**NG**

Inspect AAC valve and circuit.

**1**

◆ AAC VALVE ◆

START INSPECTION AFTER TURNING OFF A/C AND LIGHTS.

PASS START

**1**

◆ ACTIVE TEST ◆

AAC / V OPENING 10%

MONITOR

CAS.RPM(POS) 900rpm

AIR FLOW MTR 1.16V

ENG TEMP SEN 80°C

Qu UP DWN Qd

**2 Power balance test operation**

Start the engine.  
 Inspect using "POWER BALANCE" in "FUNCTION TEST" mode.  
OR use "POWER BALANCE" in "ACTIVE TEST" mode. Caution: Carry out the test in minimum time required. Do not operate during drive.  
Check if idle rev will decrease for a moment when checking each cylinders.

**NG**

To No. 5

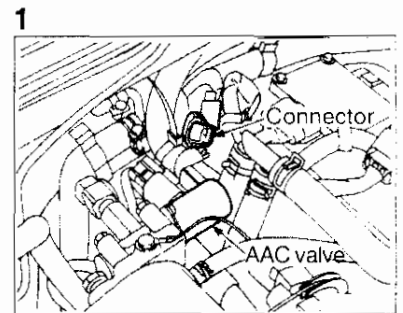

**2**

◆ POWER BALANCE ◆

FOR EACH CYLINDER STOP INJECTOR OPERATION AND CHECK THE BALANCE OF EACH CYLINDER. TURN OFF A/C AND LIGHTS

PASS START

**2**

◆ ACTIVE TEST ◆

POWER BALANCE

CAS.RPM (POS) rpm

AIR FLOW MTR V

AAC VALVE %

1	2	3	4	MONITOR START
5	6			

**3 OK**

**Injector inspection**

Place ignition switch to OFF position.  
Remove crank angle sensor.  
Remove power transistor connector.  
Place ignition switch from OFF to ON position.  
Check if each injector operation noise can be heard when the crank angle sensor shaft is rotated by hand.

**NG**

TO 4

Injector and circuit inspection.

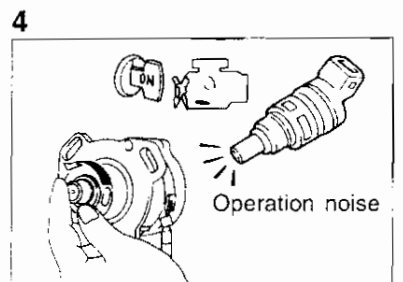

RB25DE ENGINE

4

**Ignition inspection**

Place ignition switch to OFF position.  
Remove ignition coil.  
Install normal spark plug. Face the spark plug rear end towards adequate ground such as collector and crank the engine.  
Check the spark.

NG

OK

Inspect ignition coil, power transistor and circuit.

4

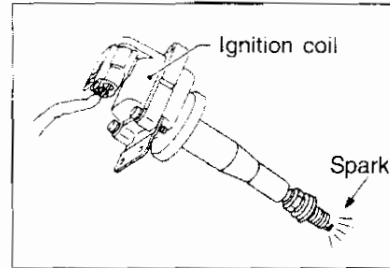

5

**Fuel pressure inspection**

Start the engine.  
Bring fuel pressure to zero by selecting "FUEL PUMP RELAY" in "ACTIVE TEST" mode.  
Crank 2 to 3 times after engine stop.  
Use fuel pressure gauge to inspect:  
When idling: Approx. 2.5kg/cm<sup>2</sup>  
When pressure regulator vacuum hose is removed: Approx. 3.0kg/cm<sup>2</sup>

Start the engine.  
Bring fuel pressure to zero by removing fuel pump fuse No. 8.  
Crank 2 to 3 times after engine stop.  
Inspect using fuel pressure gauge.

OK

5

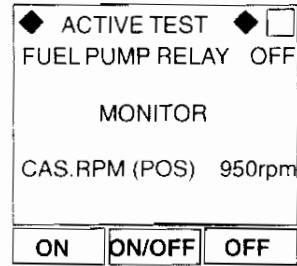

5

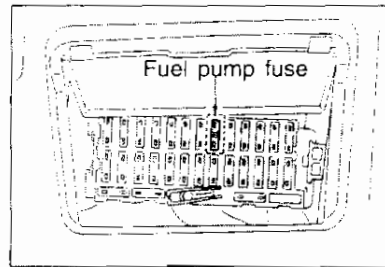

**ECCS C/U connector inspection**

Check for any damage or loose connection on the C/U bin terminal and harness connector.

NG

OK

Repair or replace

Inspect ECCS C/U power supply and ground circuit.

NG

OK

Repair or replace

Try replacing with normal C/U.

OK

**FINISH**

5

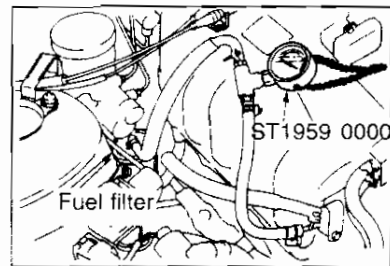



**DIAGNOSIS 35 (Phenomenon) - ENGINE STALL WHEN DECELERATING**

**1 AAC valve inspection**

Warm engine.  
 Inspect using "AAC VALVE" in "FUNCTION TEST" OR  
 Select "AAC VALVE ADJ" in "ACTIVE TEST".  
 Check if the engine rev will change when "Qu" or "Qd" is selected to change AAC valve opening.

Start the engine.  
 Check if engine rev will decrease when AAC valve connector is disconnected.

**1**

◆ AAC VALVE ◆

START INSPECTION AFTER TURNING OFF A/C AND LIGHTS.

PASS START

**1**

◆ ACTIVE TEST ◆

AAC / V OPENING 10%

MONITOR

CAS.RPM(POS) 900rpm

AIR FLOW MTR 1.16V

ENG TEMP SEN 80°C

Qu UP DWN Qd

Inspect AAC valve and circuit.

**2 Adjust screw fixation inspection**

Inspect using "AAC VALVE ADJUSTMENT" in "OPERATION SUPPORT" mode.  
 Check if it is possible to set idle speed to 650rpm ("N" range for A/T) by turning idle adjustment screw.

Disconnect throttle sensor connector.  
 Check if it is possible to set idle speed to 650rpm ("N" range for A/T) by turning idle adjustment screw.

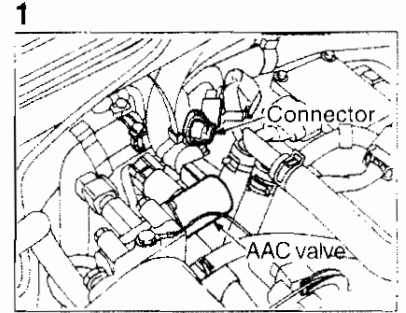

**2**

◆ AAC VALVE ADJ ◆

ADJUST CAS RPM TO STANDARD VALUE UNDER THE FOLLOWING CONDITION:  
 AFTER WARM UP  
 TURN OFF A/C AND LIGHTS

START

Inspect AAC valve and throttle valve fixation.

**3 Power balance test operation**

Start the engine.  
 Inspect using "POWER BALANCE" in "FUNCTION TEST" mode.  
 OR use "POWER BALANCE" in "ACTIVE TEST" mode. Caution: Carry out the test in minimum time required. Do not operate during drive.  
 Check if idle rev will decrease for a moment when checking each cylinders.

Start the engine.  
 Check if idle rev will decrease for a moment when each cylinder injector connector is disconnected.

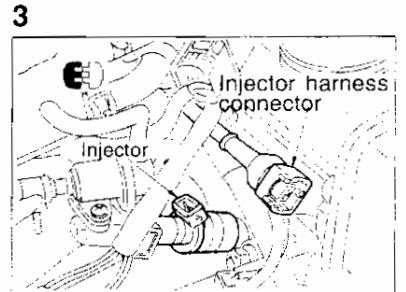

**3**

◆ ACTIVE TEST ◆

POWER BALANCE

CAS.RPM (POS) rpm

AIR FLOW MTR V

AAC VALVE %

1 2 3 4 MONITOR

5 6 START

To No. 6

OK

4

**Injector inspection**

Place ignition switch to OFF position.  
Remove crank angle sensor (leave harness connector connected).  
Remove power transistor connector.  
Place ignition switch from OFF to ON position.  
Check if each injector operation noise can be heard when the crank angle sensor shaft is rotated by hand.

NG

Injector and circuit inspection.

4

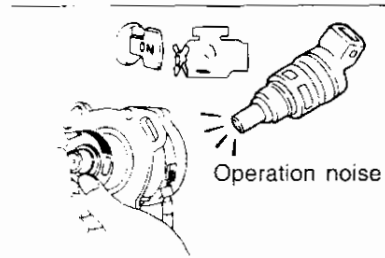

5

**Ignition inspection**

Place ignition switch to OFF position.  
Remove ignition coil.  
Install normal spark plug. Face the spark plug rear end towards adequate ground such as collector and crank the engine.  
Check the spark.

NG

Inspect ignition coil, power transistor and circuit.

5

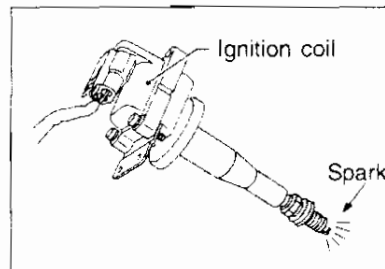

OK

6

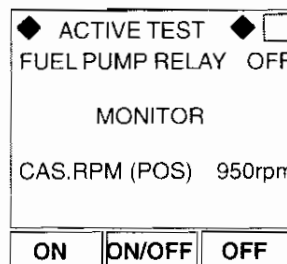

6

**Fuel pressure inspection**

Start the engine.  
Bring fuel pressure to zero by selecting "FUEL PUMP RELAY" in "ACTIVE TEST" mode.  
Crank 2 to 3 times after engine stop.  
Use fuel pressure gauge to inspect:  
When idling: Approx. 2.5kg/cm<sup>2</sup>  
When pressure regulator vacuum hose is removed: Approx. 3.0kg/cm<sup>2</sup>

NG

Inspect pressure regulator diaphragm.

6

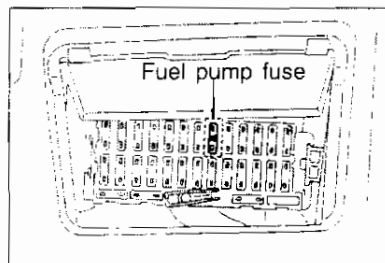

Start the engine.  
Bring fuel pressure to zero by removing fuel pump fuse No. 8.  
Crank 2 to 3 times after engine stop.  
Inspect using fuel pressure gauge.

6

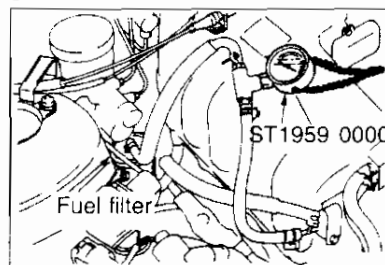

TO 7

7

**Exhaust gas sensor inspection**

Inspect using "BASE AIR-FUEL RATIO" in "FUNCTION TEST" mode.  
 Select "O<sub>2</sub> SENSOR MONITOR" in data monitor.  
 Set at 2000rpm with no load after warm up.  
 Check if the display "LEAN, RICH" will repeat for more than 5 times within 10 seconds.

Operate vehicle side (within fuse box) diagnosis connector and change to "O<sub>2</sub> sensor monitor".  
 Set at 2000rpm with no load after warm up.  
 Check if the exhaust temperature warning lamp will flash for more than 5 times within 10 seconds.

NG

2

☆MONITORING☆	NO FAIL	<input type="checkbox"/>
CAS.RPM (REF)	825rpm	
O2 SENSOR	0.02V	
O2 SENSOR MTR	RICH	

**START**

2

To change diagnostic mode, short-circuit these terminals for approx. 2 secs then open the terminals changes each operation is (the mode time this operation is performed)

(Fuse block)

2

Red lamp

Exhaust temp warning lamp

OK

Replace O<sub>2</sub> sensor

Inspect throttle sensor and vehicle speed sensor.

OK

**ECCS C/U connector inspection**  
 Check for any damage or loose connection on the C/U bin terminal and harness connector.

NG

OK

Repair or replace

Inspect ECCS C/U power supply and ground circuit.

NG

OK

Repair or replace

Try replacing with normal C/U.

OK

**FINISH**

**DIAGNOSIS 36 (Phenomenon) - ENGINE STALL WHEN ACCELERATING OR DRIVING AT CONSTANT SPEED**

1

**Power balance test operation**

Start the engine.  
 Inspect using "POWER BALANCE" in "FUNCTION TEST" mode.  
 OR use "POWER BALANCE" in "ACTIVE TEST" mode. Caution: Carry out the test in minimum time required. Do not operate during drive.  
 Check if idle rev will decrease for a moment when checking each cylinders.

Start the engine.  
 Check if idle rev will decrease for a moment when each cylinder injector connector is disconnected.

NG

1

◆POWER BALANCE◆

STOP INJECTOR OPERATION FOR EACH CYLINDER TO CHECK THE BALANCE OF EACH CYLINDERS.

PASS START

1

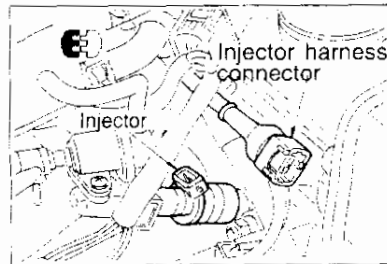

2 OK

To No. 4

**Injector inspection**

Place ignition switch to OFF position.  
 Remove crank angle sensor (leave harness connector connected).  
 Remove power transistor connector.  
 Place ignition switch from OFF to ON position.  
 Check if each injector operation noise can be heard when the crank angle sensor shaft is rotated by hand.

NG

2

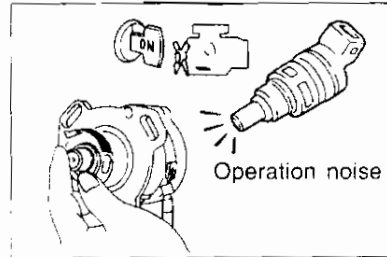

Injector and circuit inspection.

3

**Ignition inspection**

Place ignition switch to OFF position.  
 Remove ignition coil.  
 Install normal spark plug. Face the spark plug rear end towards adequate ground such as collector and crank the engine.  
 Check the spark.

NG

3

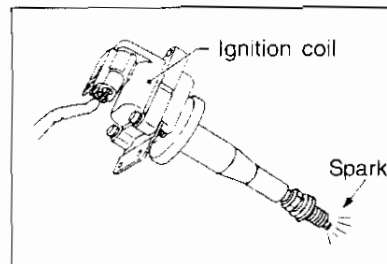

OK

TO 4

Inspect ignition coil, power transistor and circuit.

4

**Fuel pressure inspection**

 Start the engine.  
 Bring fuel pressure to zero by selecting "FUEL PUMP RELAY" in "ACTIVE TEST" mode.  
 Crank 2 to 3 times after engine stop.  
 Use fuel pressure gauge to inspect:  
 When idling: Approx. 2.5kg/cm<sup>2</sup>  
 When pressure regulator vacuum hose is removed: Approx. 3.0kg/cm<sup>2</sup>

 Start the engine.  
 Bring fuel pressure to zero by removing fuel pump fuse No. 8.  
 Crank 2 to 3 times after engine stop.  
 Inspect using fuel pressure gauge.

4

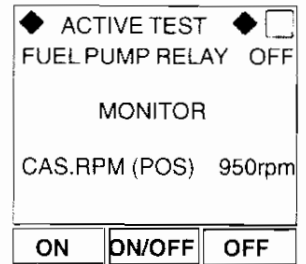

4

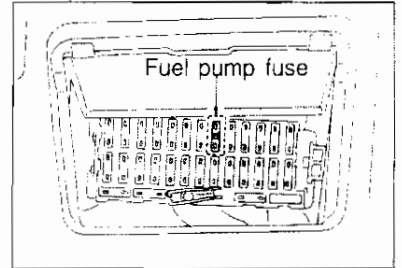

OK

Inspect pressure regulator diaphragm.

4

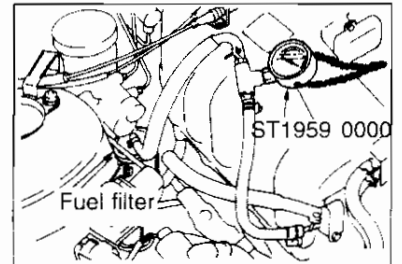

5

**Intake air leak inspection**

Start the engine.  
 Check if engine rev will increase when blow-by hose is pinched.

NG

OK

Repair any leaks

6

**ECCS C/U connector inspection**

Check for any damage or loose connection on the C/U bin terminal and harness connector.

NG

OK

Repair or replace

5

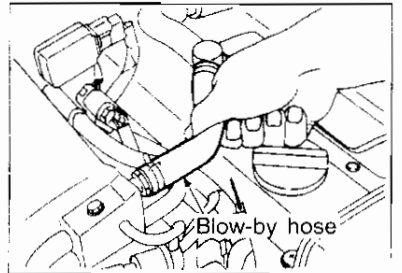

7

Inspect ECCS C/U power supply and ground circuit.

NG

OK

Repair or replace

8

Try replacing with normal C/U.

OK

FINISH

DIAGNOSIS 37 (Phenomenon) - ENGINE STALL WHEN LOADING BATTERY

1 Inspect battery and alternator NG Repair or replace

2 Power balance test operation Start the engine. Inspect using "POWER BALANCE" in "FUNCTION TEST" mode. OR use "POWER BALANCE" in "ACTIVE TEST" mode. Caution: Carry out the test in minimum time required. Do not operate during drive. Check if idle rev will decrease for a moment when checking each cylinders. Start the engine. Check if idle rev will decrease for a moment when each cylinder injector connector is disconnected.

NG

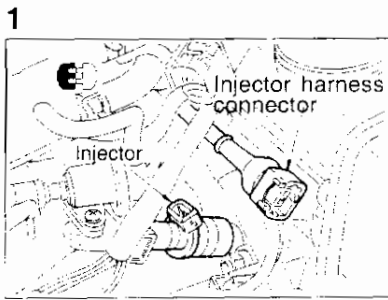
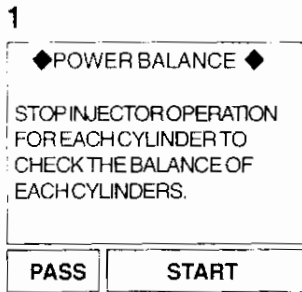

OK

To No. 4

3 Injector inspection Place ignition switch to OFF position. Remove crank angle sensor (leave harness connector connected). Remove power transistor connector. Place ignition switch from OFF to ON position. Check if each injector operation noise can be heard when the crank angle sensor shaft is rotated by hand.

NG

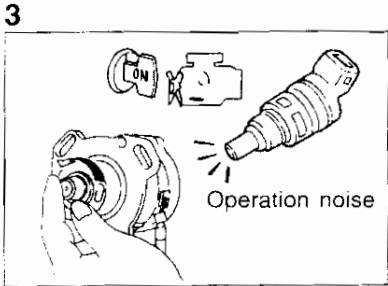

Injector and circuit inspection.

4 Ignition inspection Place ignition switch to OFF position. Remove ignition coil. Install normal spark plug. Face the spark plug rear end towards adequate ground such as collector and crank the engine. Check the spark.

NG

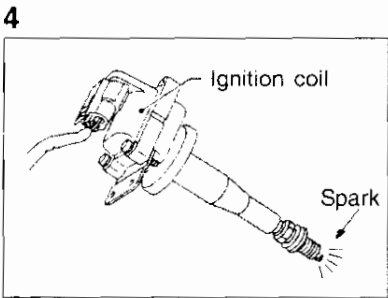

OK

TO 5

Inspect ignition coil, power transistor and circuit.

5

**Fuel pressure inspection**  
 Start the engine.  
 Bring fuel pressure to zero by selecting "FUEL PUMP RELAY" in "ACTIVE TEST" mode.  
 Crank 2 to 3 times after engine stop.  
 Use fuel pressure gauge to inspect:  
 When idling: Approx. 2.5kg/cm<sup>2</sup>  
 When pressure regulator vacuum hose is removed: Approx. 3.0kg/cm<sup>2</sup>

Start the engine.  
 Bring fuel pressure to zero by removing fuel pump fuse No. 8.  
 Crank 2 to 3 times after engine stop.  
 Inspect using fuel pressure gauge.

5

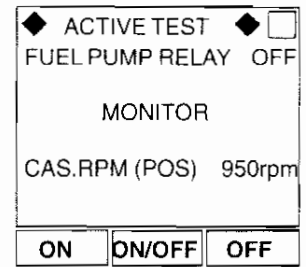

NG

Inspect pressure regulator diaphragm.

5

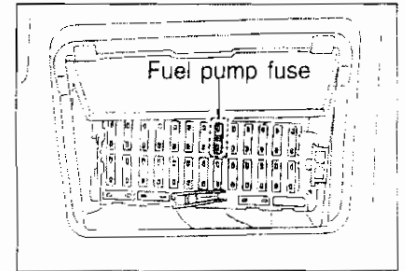

OK

6

**ECCS C/U connector inspection**  
 Check for any damage or loose connection on the C/U bin terminal and harness connector.

NG

Repair or replace

5

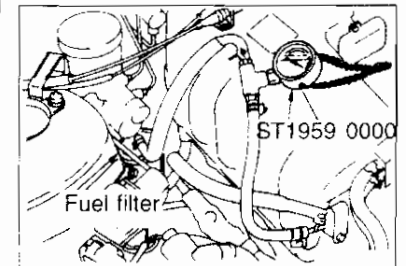

OK

7

Inspect ECCS C/U power supply and ground circuit.

NG

Repair or replace

OK

8

Try replacing with normal C/U.

OK

**FINISH**

**DIAGNOSIS 38 (Phenomenon) - POWER SHORTAGE AND STUMBLE**  
**(Instant power output shortage during acceleration)**

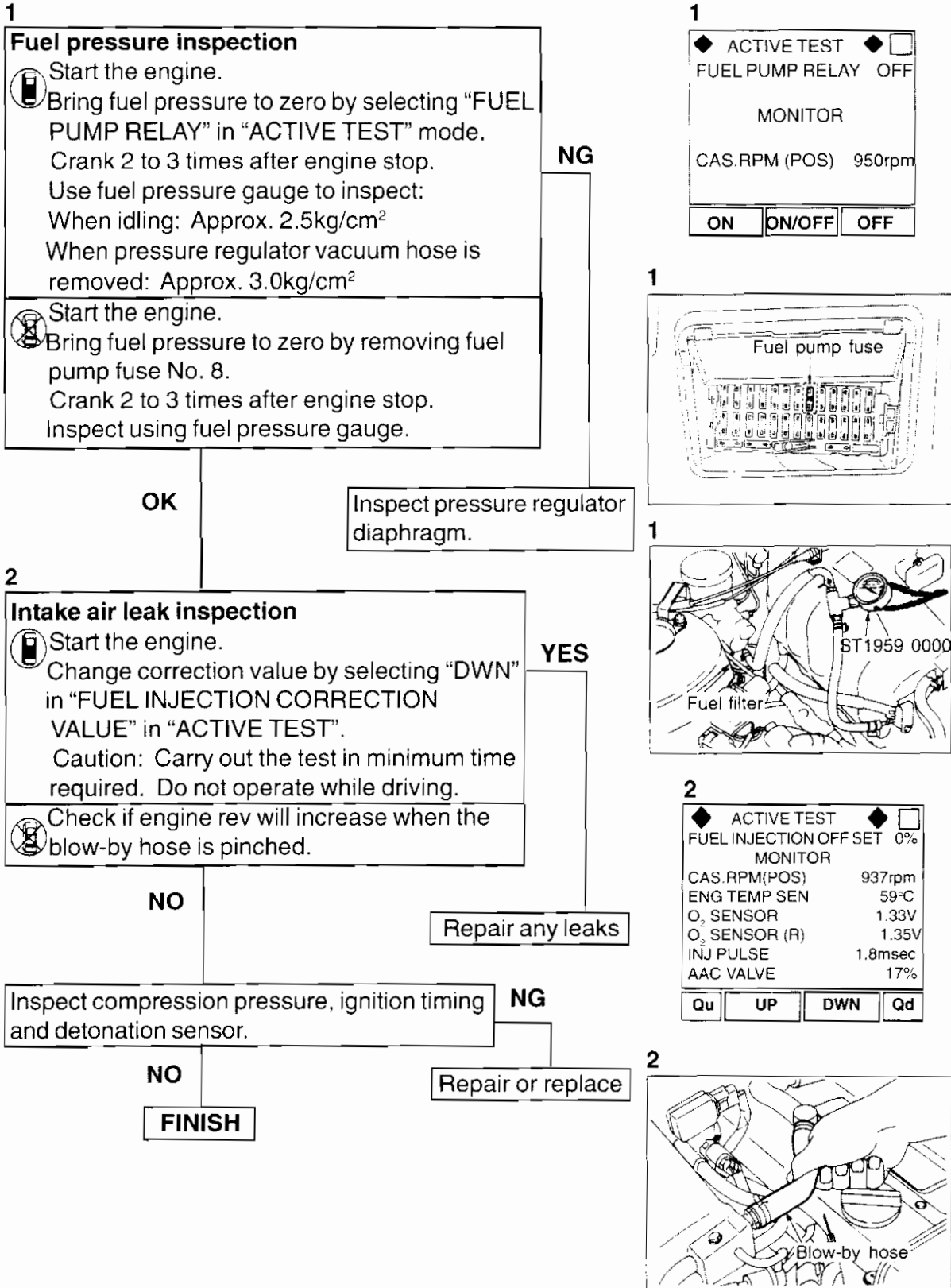



**DIAGNOSIS 39 (Phenomenon) - DETONATION**

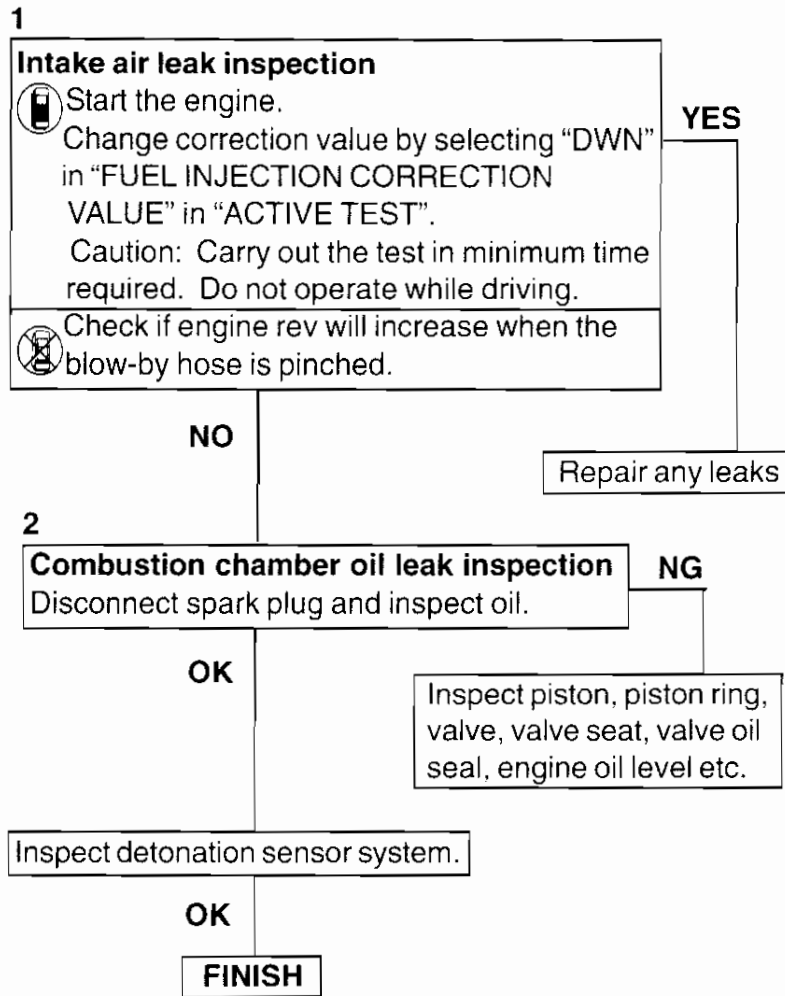

**1**

◆	ACTIVE TEST	◆	<input type="checkbox"/>
FUEL INJECTION OFF SET 0%			
MONITOR			
CAS.RPM(POS)	937rpm		
ENG TEMP SEN	59°C		
O <sub>2</sub> SENSOR	1.33V		
O <sub>2</sub> SENSOR (R)	1.35V		
INJ PULSE	1.8msec		
AAC VALVE	17%		
Qu	UP	DWN	Qd

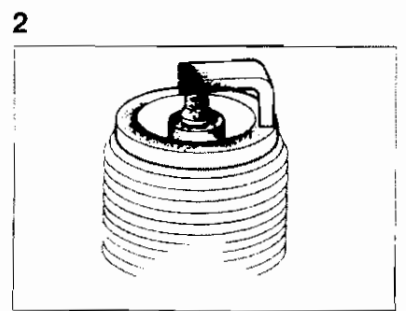
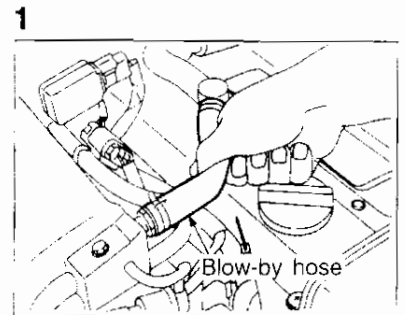

**DIAGNOSIS 40 (Phenomenon) - SURGE**

1

**Exhaust gas sensor inspection**

 Inspect using "BASE AIR-FUEL RATIO" in "FUNCTION TEST" mode.  
 Select "O<sub>2</sub> SENSOR MONITOR" in data monitor.  
 Set at 2000rpm with no load after warm up.  
 Check if the display "LEAN, RICH" will repeat for more than 5 times within 10 seconds.

 Operate vehicle side (within fuse box) diagnosis connector and change to "O<sub>2</sub> sensor monitor".  
 Set at 2000rpm with no load after warm up.  
 Check if the exhaust temperature warning lamp will flash for more than 5 times within 10 seconds.

NG

1

◆BASE AIR FUEL RATIO TEST◆

HOLD ENGINE REV 2000+/- 200rpm AND PRESS START.

1800 2000 2200

PASS START

1

★MONITORING★ NO FAIL

CAS.RPM (REF) 825rpm  
 O2 SENSOR 0.02V  
 O2 SENSOR MTR RICH

START

Replace O<sub>2</sub> sensor

2

OK

2

Replace ECCS C/U

OK

FINISH

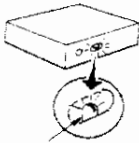
 Red lamp

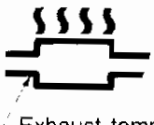
 Exhaust temp warning lamp

**DIAGNOSIS 41 (Phenomenon) - BACK FIRE (SPITTING)**

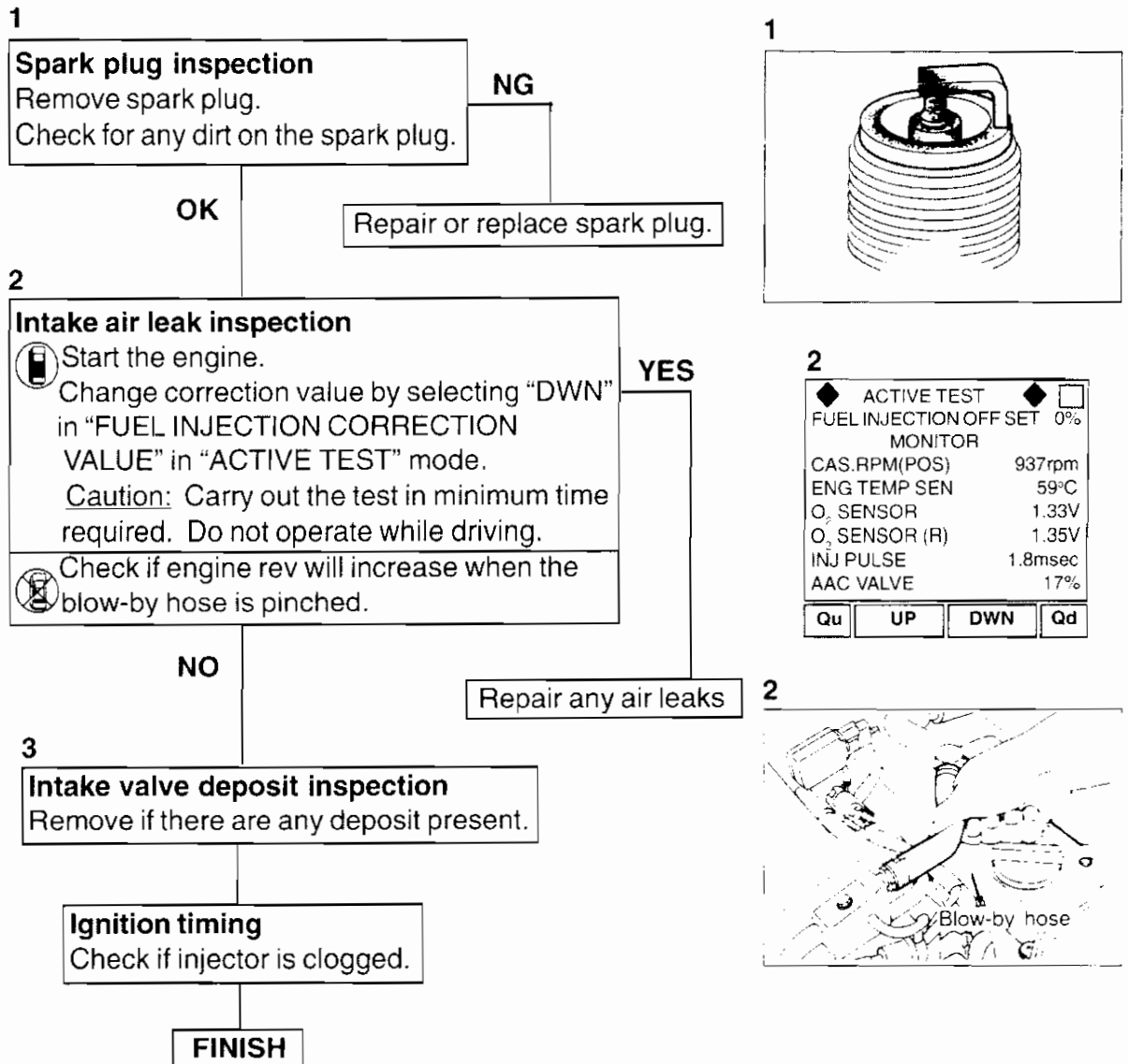

**DIAGNOSIS 42 (Phenomenon) - AFTER BURNING**

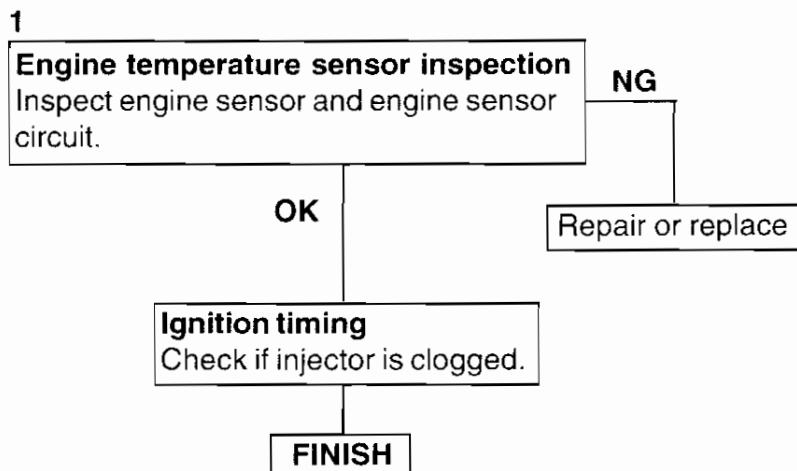

## 8. COMPONENTS INSPECTION (RB25DE) CRANK ANGLE SENSOR

### Inspection

- Remove crank angle sensor from the engine. (leave crank angle sensor harness connector connected).
- Place ignition switch to ON position.
- Rotate crank angle sensor shaft slowly with hand and inspect the voltage between terminal 2, 3 and ground.

Condition	Between crank angle sensor terminal 2 and ground (1° signal)	Between crank angle sensor terminal 3 and ground (120° signal)
Ignition switch in ON position	Approx. 0.1V or Approx. 5V	Approx. 0.1V or Approx. 5V

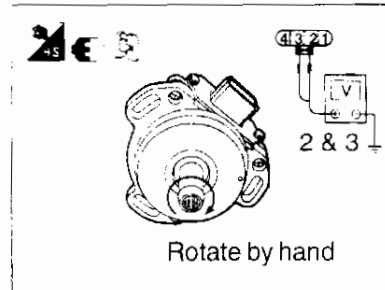

IF NG: Replace crank angle sensor.

Erase self diagnosis result from CONSULT after inspection.

Check code No. 11 is not displayed in the screen.

### Caution:

Remove injector fuse or connector to avoid injector from operating while inspection.

## AIR FLOW METER

### Inspection

- Remove air flow meter from the engine.
- Apply battery voltage directly between air flow meter terminal 5+ and terminal 3- and blow air to hot wire. Check for any change in output voltage between terminal 2+ and terminal 4-.

Air is not blown	Approx. 0.8V
Air is blown	Approx. 2V

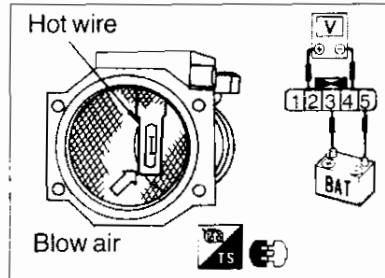

IF NG: Replace air flow meter OR check for any damage with the hot wire.

Erase self diagnosis result from CONSULT after inspection.

Check code No. 12 is not displayed in the screen.

## ENGINE TEMPERATURE SENSOR

### Inspection

- Disconnect engine temperature sensor harness connector.
- Measure the resistance between engine temperature sensor harness terminal 1 and 2.

Cooling water temperature	Approx. 20°C	Approx. 2.5K $\Omega$
	Approx. 80°C	Approx. 0.3K $\Omega$

IF NG: Replace engine temperature sensor.

Erase self-diagnosis result from CONSULT after inspection.

Check code No. 31 is not displayed in the screen.

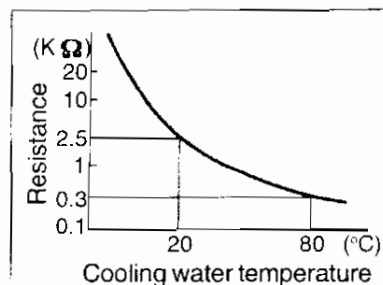

**IGNITION COIL**

**Inspection**

- Disconnect ignition coil harness connector.
- Measure the resistance between following terminals.

Primary coil resistance value (1 - 2)	0.6 ~ 0.9
---------------------------------------	-----------

IF NG: Replace ignition coil

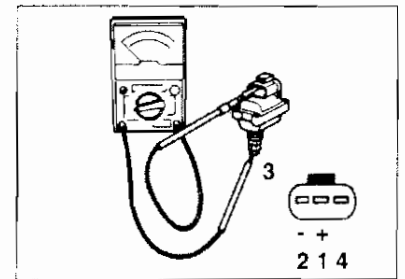

**POWER TRANSISTOR**

**Inspection**

- Disconnect power transistor harness connector.
- Measure the resistance by inserting analog type circuit tester inspection rod - and + to power transistor terminals.

1 - 3	+/- $\infty \Omega$ -/+ $\infty \Omega$
2 - 3	+/- $\infty \Omega$ > -/+ 0 or not $\infty \Omega$
1 - 3	+/- 0 or not $\infty \Omega$ < -/+ $\infty \Omega$

IF NG: Replace power transistor.

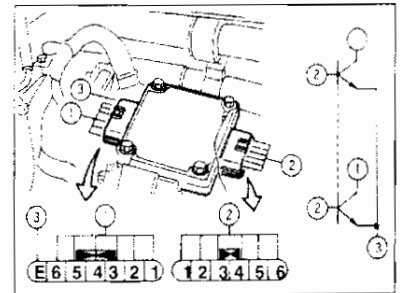

**FUEL PUMP**

**Inspection**

- Disconnect fuel pump harness connector.
- Measure the resistance between fuel pump terminal 1 and 3.

**Resistance: Approx. 0.4 ~ 0.7**

- Check for operation by applying battery voltage between the following terminals directly:

**Connect terminal 3 to + side, terminal 1 to - side.**

Caution: Care must be taken to connect battery to correct sides.

IF NG: Replace fuel pump.

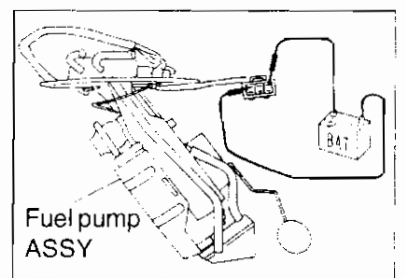
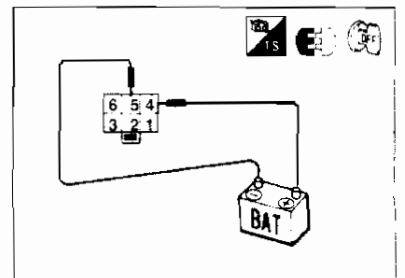

**THROTTLE VALVE SWITCH**

**Inspection**

- Warm the engine.
- Disconnect throttle valve switch connector and measure the resistance between throttle valve switch terminals.

**(Idle contact point)**

Condition	Between throttle valve switch terminals 2 and 1
Accelerator pedal is not pressed	0 $\Omega$
Accelerator pedal pressed	$\infty \Omega$

IF NG: Repair throttle valve switch.

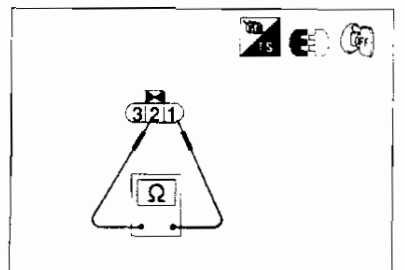

## Adjustment

### Idle contact point touch rev (rpm): 750 ~ 1050

- Adjust if the touch rev is not within the range above.
- Disconnect throttle valve switch connector and loosen the bolt.
- Gradually increase the engine rev so idle contact point is ON (Resistance between terminal 2 and 1 is  $0\ \Omega$ ) at above engine speed. Move throttle valve switch unit to touch point and tighten the bolt. Move throttle valve switch unit to touch point and tighten the bolt.
- Install throttle valve switch connector.
- Race the engine few times and check idle rev is within the standard value.

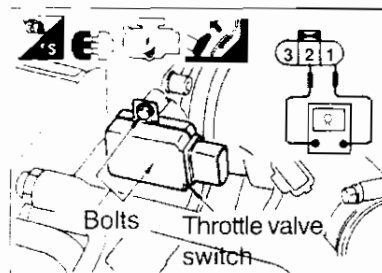

## THROTTLE SENSOR

Disconnect throttle sensor connector.

Measure the resistance between throttle sensor terminal 2 and 3.

Accelerator pedal condition	Resistance K
Not pressed	Approx. 0.4
Pressed to half way	Approx. 0.4 ~ 5
Completely pressed	Approx. 5

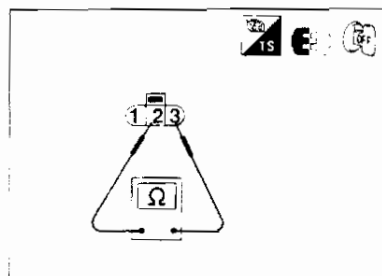

IF NG: Replace throttle valve switch.

After inspection erase self diagnosis result from CONSULT.  
Check code No. 43 will not display in the screen.

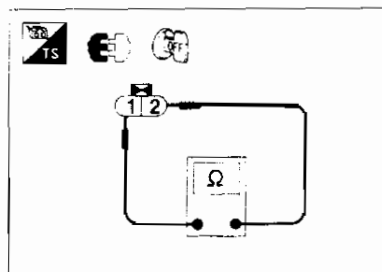

## AAC VALVE

- Inspect the resistance of AAC valve.  
**Resistance: Approx. 9 ~ 10**

- Plunger and switch inspection.
- Spring damage inspection.

IF NG: Replace AAC valve.

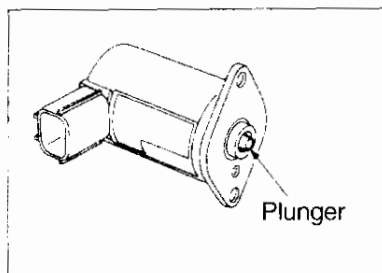

## FICD SOLENOID

- Measure the resistance of FICD solenoid.  
**Resistance: Approx. 22 ~ 23**

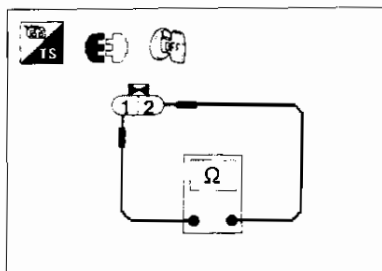

- Plunger and switch inspection.
- Spring damage inspection.

IF NG: Replace FICD solenoid.

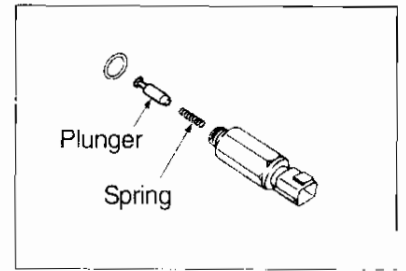

**AIR REGULATOR**

**Static characteristic inspection**

- Visually check the shutter opening.

Area temperature (°C)	Shutter opening
Below -20°C	Fully open
20°C	Approx. half open
Over 60°C	Fully closed

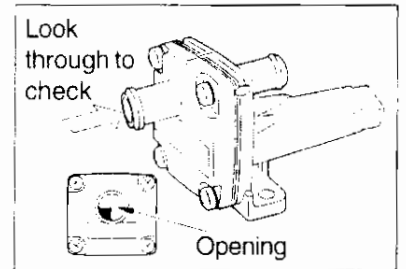

**Dynamic characteristic inspection**

- Apply battery voltage to terminals and inspect for any change with shutter opening.  
**The shutter will close gradually and completely closed within 7 minutes. (area temperature approx. 20°C).**

Reference: Heater resistance value: 70 ~ 80 Ω (20°C)

IF NG: Replace air regulator.

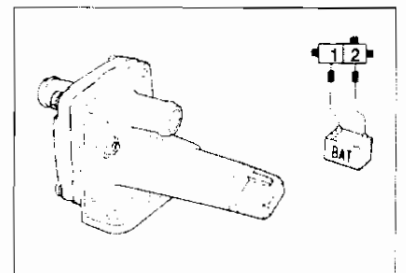

**INJECTOR**

**Inspection**

- Disconnect injector harness connector.
- Measure the resistance of each injector cylinder terminal 1 and 2.

Resistance between injector terminal 1 and 2 (each cylinder)	13 ~ 14 Ω
--	-----------

IF NG: Replace injector.

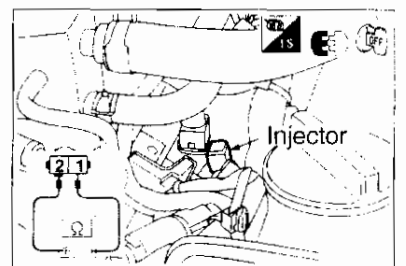

**ECCS RELAY, FUEL PUMP RELAY, RADIATOR FAN MOTOR RELAY**

**Inspection**

- Directly apply battery voltage between terminal 1 and 2.
- Inspect continuity between terminal 3 and 5.

Condition	Continuity
Directly apply battery voltage between terminal 1 and 2	Present
No battery voltage	Not present

IF NG: Replace relay.

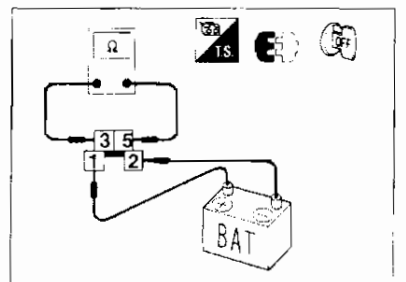

**IGNITION RELAY, INHIBITOR RELAY**

**Inspection**

- Directly apply battery voltage between terminal 1 and 2.
- Check for continuity between terminal 3 and 4, 6 and 7.

Condition	Continuity	
	3 and 4	6 and 7
Directly apply battery voltage between terminal 1 and 2	Not present	Present
No battery voltage	Present	Not present

IF NG: Replace relay.

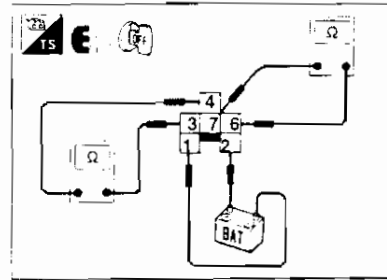

**POWER STEERING HYDRAULIC PRESSURE INSPECTION**

**Inspection**

- Remove power steering hydraulic pressure switch harness connector.
- Check for continuity between the terminals.

Condition	Continuity
Steering wheel is steered	Present
Steering wheel is not steered	Note present

IF NG: Replace power steering hydraulic pressure switch.

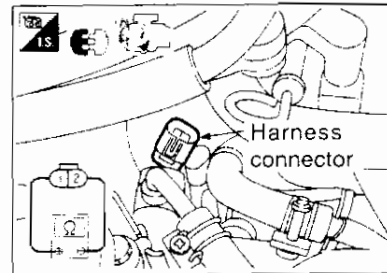

**SPARK PLUG**

**Inspection & Adjustment**

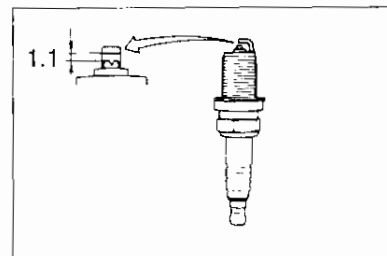

- Measure the gap between electric pole.
- Replace or repair if out of standard range.

**Standard gap (mm): 1.0 ~ 1.1**



**FUEL SYSTEM INSPECTION**

**Simple inspection**

- Turn the ignition switch to ON position. 
- Select "Fuel pump" in the "Function test" mode.
- Inspect the pulsation by holding the fuel hose with hand.
- Hold the fuel filter and make sure the hose is hard and pulsation can be felt when the fuel pump is operating. 

◆ FUEL PUMP ◆

IS THERE A PULSATION EVERY 3 SECONDS WHEN THE FUEL TUBE IS HELD? OR CAN YOU HEAR THE OPERATION NOISE OF THE FUEL PUMP RELAY?

PASS    NO    YES

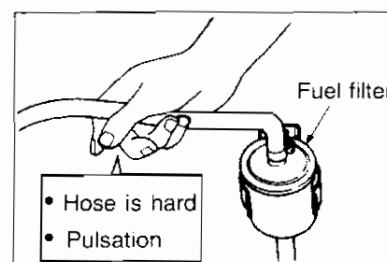





**Fuel pressure inspection using the fuel pressure meter**

**Releasing fuel pressure**

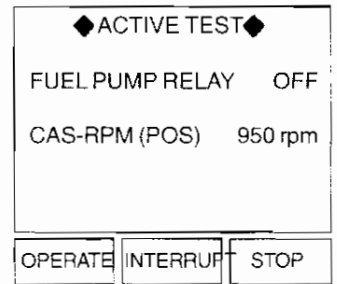
- Run the engine. 
- Select "Fuel pump relay" in "Active test" mode.
- Press 'STOP' to stop the engine. Crank the engine over two or three times. (If the engine does not start, crank 3 ~ 4 times after removing the fuse).



- Restart the engine and remove the fuel pump fuse. 
- After the engine stops, crank the engine 4 ~ 5 times to consume the fuel in the pipe. (If the engine does not start crank 4 ~ 5 times after removing the fuse).

**Caution:**

The battery may become weak easily, use booster cable to connect to another battery if necessary.

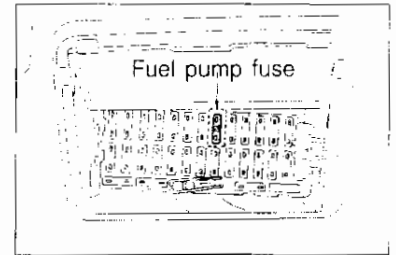

**Fuel pressure meter installation**

- Connect the fuel pressure meter between the fuel filter and the fuel line.
- Attach the fuel pump fuse.

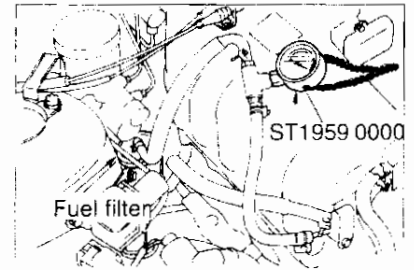

**Fuel pressure inspection**

- Start the engine and check if the fuel pressure is at standard value.

Idling (kg / cm <sup>2</sup> )	Approx. 2.55
Pressure regulator vacuum hose is disconnected (kg / cm <sup>2</sup> )	Approx. 3.0

- If the engine does not start, check fuel pressure 5 seconds after the ignition switch has been turned ON.

5 seconds after ignition switch turned to ON	Approx. 3.0
--	-------------

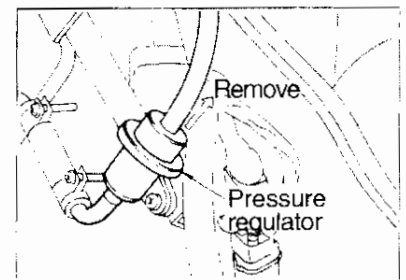

**IF NG:**

Fuel pressure is extremely high	Pressure regulator is not working. Return system is clogged, hose bent.
Fuel pressure is extremely low	Pressure regulator is not working. Fuel pump discharge defect. Fuel system clogged

**Fuel cut system inspection**

- Select "INJ pulse" in "DATA MONITOR" mode using CONSULT. Increase the engine rev to 2000rpm after starting the engine. Check that "INJ pulse" will decrease to 0.6 msec for a moment when the accelerator pedal is released.

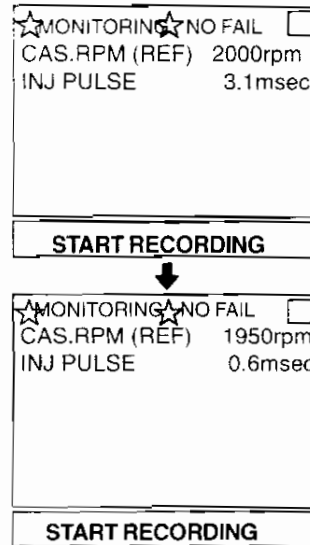

**EVAPORATIVE GAS CONTROL SYSTEM INSPECTION**

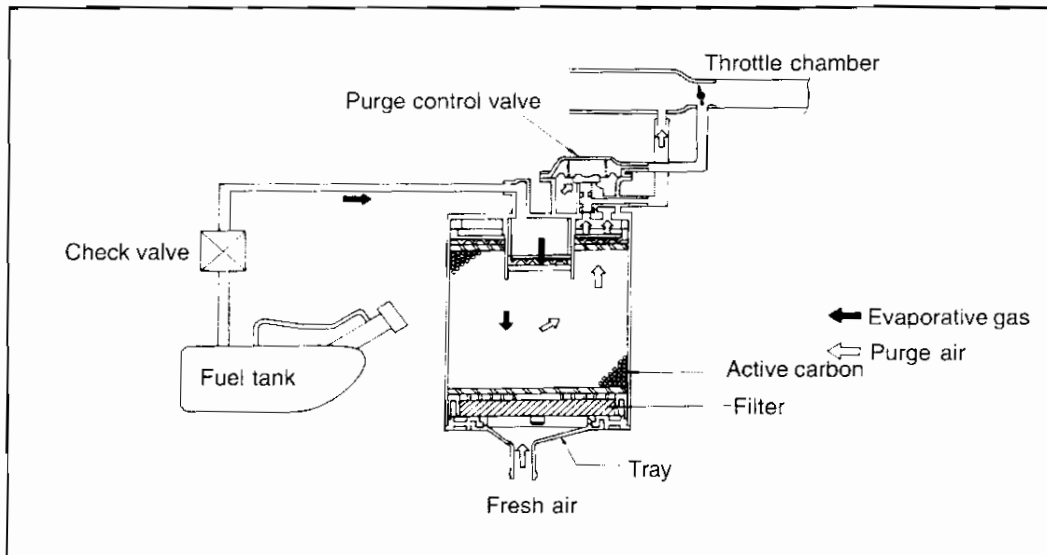

**CANISTER Inspection**

- Connect vacuum hand pump to canister throttle negative pressure opening and make sure the vacuum pressure is maintained.
- Apply approx. -100mmHg pressure and make sure the manifold negative pressure opening is continued by sucking air from the opening.

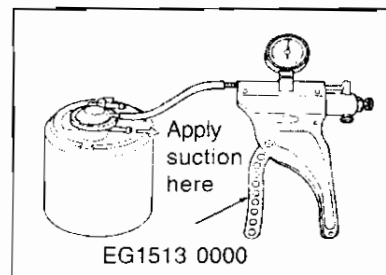

**FUEL TANK VACUUM RELIEF VALVE Inspection**

- Clean the valve housing.
- If the fuel tank vacuum relief valve is normal, you will hear sound from the valve with small resistance when the air is sucked in through the cap.
- Replace the cap ASSY if the valve is closed or when resistance is felt.

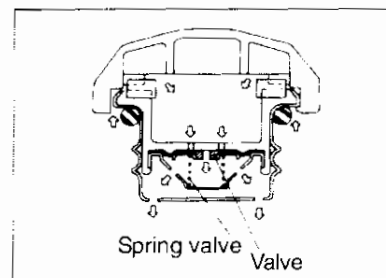

**BLOWBY GAS REDUCTION DEVICE INSPECTION**

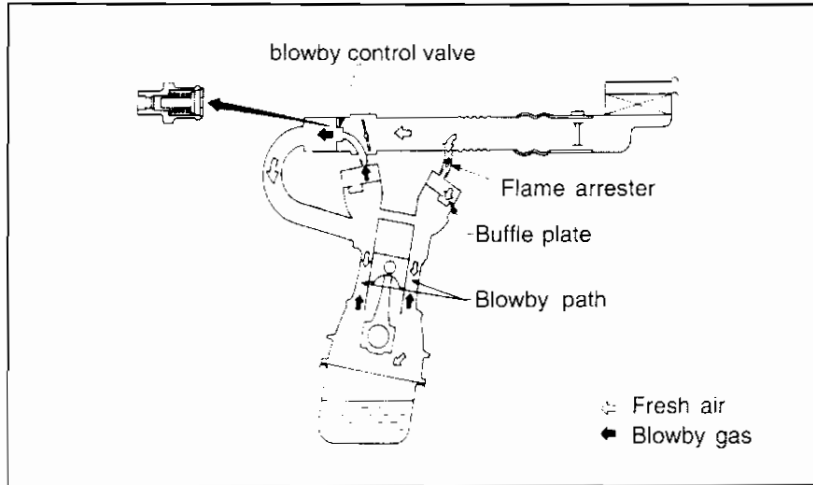

**BLOWBY CONTROL VALVE INSPECTION**

**Inspection**

- Idle the engine and remove hose from blowby control valve.
- Check if operation noise can be heard from the air passage when valve is operating normally.
- Check the blowby control valve flow path.

	CONDITION
Air is blown	Air passes
Air is drawn in	No air passes

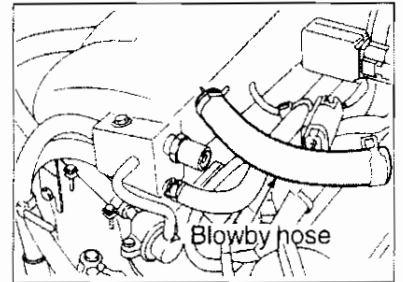

**BLOWBY HOSE**

**Inspection**

- Look for any leakage from the hose and connection area.
- Remove the hose and clean using the air blow. Replace hose if there are any clogs.

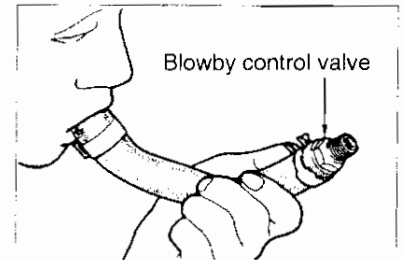

## RB26DETT ENGINE

## 9. ECCS CONTROL UNIT INPUT / OUTPUT SIGNALS

## 9-1 CONSULT INSPECTION VALUES

## (1) Data monitor

Note: The output signal is displayed as the calculation data on console unit so the correct value will displayed even if the output circuit (harness) is inadvertently disconnected.

## RB26DETT ENGINE

MONITORING ITEMS	DATA MONITOR		PROBLEM INSPECTION ITEM	
	CONDITION	NORMAL REFERENCE VALUE		
CAS.RPM (Detected angle speed according to signals)	Tachometer set Engine running		There must be no abnormal change in speed.	Crank angle sensor system
AIR FLOW MTR (output voltage)	After warming up engine Idling (N range, A/C OFF)	Approx. 0.7 ~ 1.2V (2000rpm with no load 1.0 ~ 1.7V) Note: 2 air flow meter value can vary 0 ~ 0.4V	Air flow meter system	
AIR FLOW MTR (R) (output voltage)				
ENG TEMP SEN (engine temperature)	After warming up engine		Above approx. 70°C	Engine temperature sensor system
EXT GAS SEN (output voltage)	After warming up engine	2000rpm with no load	Changes between 0 ~ 0.3V and 0.6 ~ 1V  RICH, LEAN repeats 5 times or more in 10 seconds	Exhaust gas sensor system Intake system air leak or air intake Injector system
EXT GAS SEN (R) (output voltage)				
EXT GAS SEN (RICH / LEAN)				
EXT GAS SEN (R) (RICH / LEAN)				
CAR SPEED SEN (vehicle speed signal)	While driving or with drive wheels turning		Should generally conform to speedometer display	Vehicle speed sensor system
BATTERY VOLT	Ignition switch ON Engine stopped		11 ~ 14V	Battery ECCS control unit power system
THROTTLE SEN (output voltage)	Ignition switch ON Engine stopped	Throttle fully closed	0.5	Throttle sensor adjustment Throttle sensor system
		Throttle fully open	4.0	
INT/A TEMP SEN (Intaktemperature sensor output)	After warming up engine		Intake air temperature is displayed	Intaktemperature sensor system
INJ PULSE (injection pulse width)	After warming up engine	Idling (N range, A/C OFF)	Reference	1.4 ~ 2.2 msec 1.4 ~ 2.2 msec
INJ PULSE (R) (injection pulse width)		2000rpm with no load		
IGN TIMING	After warming up engine	Idling (N range, A/C OFF)	20°	Air flow meter system
		2000rpm with no load	Advance greater than 10° angle compared to idle position	
AAC VALVE	After warming up engine	Idling (N range, A/C OFF)	Approx. 15 ~ 35%	IAS adjustment AAC valve system
		2000rpm with no load	Approx. 30 ~ 50%	
A/F ALPHA (air-fuel ratio feedback correction coefficient)	After warming up engine 2000rpm with no load		75 ~ 125%	Air flow meter system Injector system Canister (purge) inspection Intake system air leak or air suction
START SIGNAL	Ignition switch ON Engine stopped	"START"	ON	Starter SW system
IDLE SW		"OFF"	OFF	
	AIR COND SIG	Idle	Throttle fully closed	ON
Throttle fully open			OFF	
NEUTRAL SW	Idle	A/C SW ON	ON	Air conditioner SW system
		A/C SW OFF	OFF	
PW/ST SIGNAL	Idle	N or P range	ON	Neutral SW system
		Not N or P	OFF	
IDLE JUDGEMENT	When idle	Steering	ON	Power steering SW system
		Steering neutral	OFF	
FUEL PUMP RELAY	IGN SW ON	Stop	OFF	Fuel pump system
		When rev	ON	
AIR CON RELAY	Idle	A/C ON	ON	Air conditioner relay system
		A/C OFF	OFF	
	Accel 10 sec	A/C ON	OFF	
W/G CONT SW			ON	
			OFF	
POWER VOLTAGE	Display power voltage probe measurement value			
PULSE	Display pulse probe measurement value			

## (2) Active test

SET ITEM	ACTIVE TEST		JUDGEMENT AND INSPECTION ITEM
	CONDITION	ACTIVE TEST DESCRIPTION	
ENGINE TEMPERATURE	Problem occurrence condition	Set engine temperature high or low. <u>Caution:</u> Do not set extreme values as this can cause spark plug burning.	Perform following inspections to check if problem is solved. <u>Eliminate:</u> Engine temperature sensor system Injector system Air flow meter, exhaust gas sensor system <u>Not eliminated:</u> Other item inspection
FUEL INJECTION	Problem occurrence condition	Set the air-fuel ratio rich or lean. <u>Caution:</u> Do not set extreme values as this may damage engine or catalytic converter.	Perform following inspections to check if problem is solved. <u>Eliminate:</u> Exhaust gas sensor system Air flow meter, engine temperature sensor system Injector system <u>Not eliminated:</u> Other item inspection
IGNITION TIMING	Problem occurrence condition	Delay ignition timing. <u>Caution:</u> Do not set extreme values as this may damage engine or catalytic converter.	Perform following inspections to check if problem is solved. <u>Eliminate:</u> Ignition timing adjustment Detonation sensor system <u>Not eliminated:</u> Other item inspection
AAC VALVE OPENING	Engine running	Increase control duty ratio. The engine speed should increase. Decrease control duty ratio. The engine speed should decrease.	If the condition described on left can not be verified, check AAC valve system
POWER BALANCE	Engine running	Set the AAC valve open to stop the specified injector operation and the injector speed can be displayed at this time. <u>Caution:</u> Do not perform this operation while driving.	<u>Eliminate:</u> Injector system
FUEL PUMP RELAY	Ignition switch ON Engine stop	Turn ignition switch ON, OFF and ON so pump operation makes a sound. The fuel pressure will rise. <u>Caution:</u> Do not perform this operation except under conditions described on left.	If the condition described on left can not be verified, check relay system of fuel pump and fuel pump system
SELF-LEARNING CONT	The air-fuel ratio feedback correction coefficient learning factor is cleared.		

# ECCS C.U INPUT OUTPUT SIGNALS

## RB26DETT ENGINE

### 9-2 OSCILLOSCOPE & CIRCUIT TESTER INSPECTION VALUE (RB26DETT ENGINE)

101	102	103	104	105	106	107	108	1	2	3	4	5	6	7	8	9	10		21	22	23	24	25	26	27	28	29	30	41	42	43	44	45	46	47	48	49	50
109	110	111	112	113	114	115	116	11	12	13	14	15	16	17	18	19	20		31	32	33	34	35	36	37	38	39	40	51	52	53	54	55	56	57	58	59	60

RX	TX				CHK	IGN
-	CLK					

Terminal No.	Signal name	Circuit	At idle		At Approx. 2,500 rpm	
			Standard	Memo	Standard	Memo
1 2 3 11 12 13	Power transistor control signal		0.2 ~ 0.3 V 		Approx. 0.4V 	
4	AAC valve control signal		Cold: 6 ~ 7V Warm: 8 ~ 10V 		Approx. 5V 	
7	Engine speed signal for tachometer		Approx. 1V 		Approx. 2.4V 	
9	Air conditioner relay		Air condition OFF: Battery voltage Air conditioner ON: Approx. 1V		Air condition OFF: Battery voltage Air conditioner ON: Approx. 1V	
16	ECCS relay		Approx. 1V (Ignition switch OFF: Battery voltage)		Approx. 0V	
18	Fuel pump relay		0V		0V	



ECCS C/U INPUT OUTPUT SIGNALS

RB26DETT ENGINE

RB26DETT ENGINE

101	102	103	104	105	106	107	108	1	2	3	4	5	6	7	8	9	10		21	22	23	24	25	26	27	28	29	30	41	42	43	44	45	46	47	48	49	50
109	110	111	112	113	114	115	116	11	12	13	14	15	16	17	18	19	20		31	32	33	34	35	36	37	38	39	40	51	52	53	54	55	56	57	58	59	60

RX	TX				CHK	IGN
-	CLK					

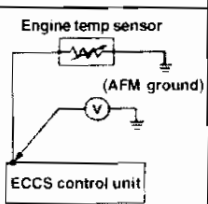
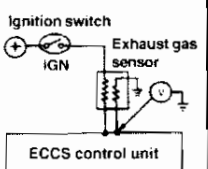
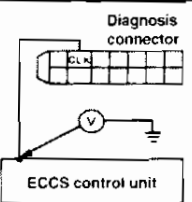
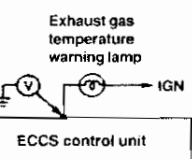
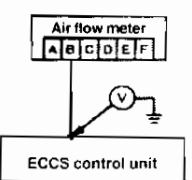
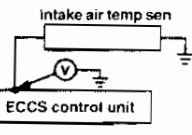
Terminal No.	Signal name	Circuit	At idle		At Approx. 2,500 rpm	
			Standard	Memo	Standard	Memo
28	Engine temperature sensor signal		Engine temperature 80°C: Approx. 1V Engine temperature 20°C: Approx. 3V		Engine temperature 80°C: Approx. 1V Engine temperature 20°C: Approx. 3V	
29	Exhaust gas sensor signal (front)		Approx. 0 ~ 1V		Defects between approx. 0 ~ 1V	
31 (CLK)	Clock (synchronization signal)		0V		0V	
32	Motor & check lamp (red lamp)		Lamp not lit: Power voltage Lamp is lit: 0V		Lamp not lit: Power voltage Lamp is lit: 0V	
35	Air flow meter (Front) (Intake air quantity signal)		Approx. 1V		Approx. 1.5V	
36	Intake air temperature sensor signal		Cold: Approx. 1.5V Warm: Approx. 0.8V		Cold: Approx. 1.5V Warm: Approx. 0.8V	



ECCS C/U INPUT/OUTPUT SIGNALS

RB26DETT ENGINE

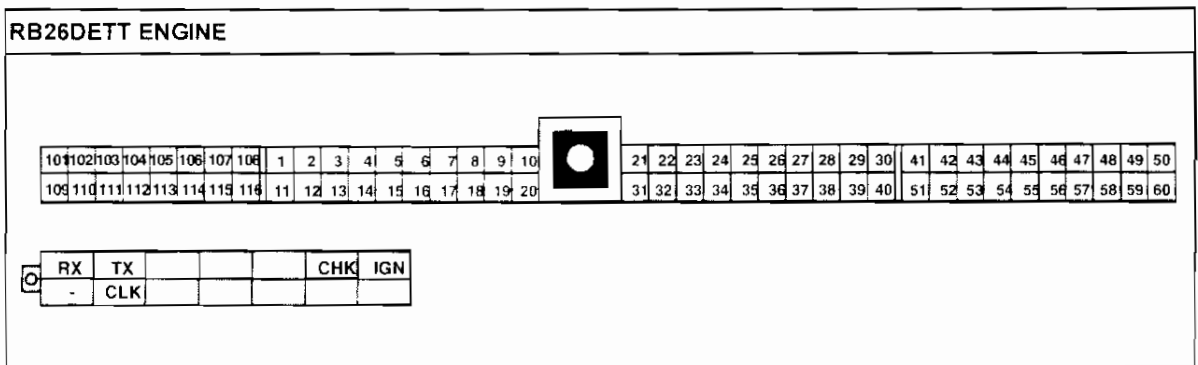

Terminal No.	Signal name	Circuit	At idle		At Approx. 2.500 rpm	
			Standard	Memo	Standard	Memo
38	Throttle sensor signal		Approx. 0.5V		0.5 ~ 4 (Voltage increases if accelerator pedal is pressed)	
41 51	Crank angle sensor 120° signal		0.3 ~ 0.7V		0.3 ~ 0.7V	
42 52	Crank angle sensor 1° signal		2 ~ 3V		2 ~ 3V	
43	Ignition switch (START signal)		0V (Ignition switch "START": Battery voltage)		0V	
44	Neutral switch signal		N or P range: 0V Other than N or P range: 4 ~ 5V		N or P range: 0V Other than N or P range: 4 ~ 5V	
46	Air conditioner switch signal		Air conditioner OFF: Battery voltage Air conditioner ON: 0V		Air conditioner OFF: Battery voltage Air conditioner ON: 0V	

# ECCS C/U INPUT/OUTPUT SIGNALS

## RB26DETT ENGINE

### RB26DETT ENGINE

101	102	103	104	105	106	107	108	1	2	3	4	5	6	7	8	9	10		21	22	23	24	25	26	27	28	29	30	41	42	43	44	45	46	47	48	49	50
109	110	111	112	113	114	115	116	11	12	13	14	15	16	17	18	19	20		31	32	33	34	35	36	37	38	39	40	51	52	53	54	55	56	57	58	59	60

⊖	RX	TX			CHK	IGN
	-	CLK				

Terminal No.	Signal name	Circuit	At idle		At Approx. 2,500 rpm	
			Standard	Memo	Standard	Memo
48	Throttle sensor (Power supply)		5V		5V	
49	Control unit power supply		Battery voltage		Battery voltage	
53	Vehicle speed sensor signal		D range (or 1st) with rear wheels jacked up: 0.5 ~ 1.5V The value actually deflects between 0V and 5V. However, it appears to deflect around 1V, according to vehicle speed.		D range (or 1st) with rear wheels jacked up: 0.5 ~ 1.5V The value actually deflects between 0V and 5V. However, it appears to deflect around 1V, according to vehicle speed.	
54	Throttle valve switch (idle contact point)		Approx. 10V		Approx. 10V	
55	Exhaust gas sensor signal (Rear)		N or P range: 0V Other than N or P range: 4 ~ 5V		N or P range: 0V Other than N or P range: 4 ~ 5V	
56	Throttle sensor output signal		Approx. 0.5V		Approx. 0.5 ~ 4V (Voltage increases as accelerator pedal is pressed).	

ECCS C/U INPUT/OUTPUT SIGNALS

RB26DETT ENGINE

RB26DETT ENGINE

101	102	103	104	105	106	107	108	1	2	3	4	5	6	7	8	9	10		21	22	23	24	25	26	27	28	29	30	41	42	43	44	45	46	47	48	49	50
109	110	111	112	113	114	115	116	11	12	13	14	15	16	17	18	19	20		31	32	33	34	35	36	37	38	39	40	51	52	53	54	55	56	57	58	59	60

<input type="checkbox"/>	RX	TX			CHK	IGN
	-	CLK				

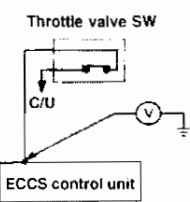
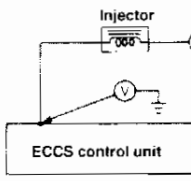
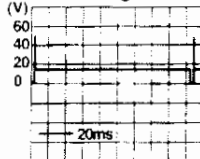
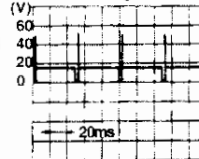
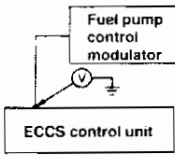
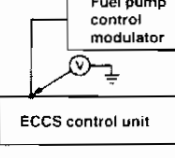
Terminal No.	Signal name	Circuit	At idle		At Approx. 2,500 rpm	
			Standard	Memo	Standard	Memo
57	Throttle valve switch (Power supply)		Battery voltage		Battery voltage	
101 103 105 110 112 114	Injector control signal		Approx. battery voltage 		Approx. battery voltage 	
104	Fuel pump terminal voltage control signal (FPCM 1)		Idling (after warming engine): 0V		During middle load: 4V	
106	Fuel pump terminal voltage control signal (FPCM 2)		-		During middle load: 0V	

### 9-3 ECCS CONTROL UNIT OPERATION CAUTIONS

#### (1) Control unit equipment

- Never install a control unit that is not specified for your vehicle.
- Do not apply excessive force to the installation bracket.

#### (2) Connector removal and installation

- When removing and installing connectors, do not bend or apply unnecessary force and observe following points:

##### 1. Connector removal

- Turn ignition switch OFF and ECCS relay OFF before removing connectors.
- Hold connector firmly to disconnect without applying force to harness.
- Do not use a screwdriver or similar tool to loosen the connector lock.

##### 2. Connector installation

- Turn ignition switch OFF.
- Make sure pins are not bent or control unit connector and then connect securely.
- Tighten bolts securely until injector surface reaches orange colour indicator of connector and surface is even.

#### (3) Control unit power

- Never make a reverse connection to the battery.
- Use battery voltage in 10 - 16V range.

#### (4) Idle speed adjustment knob

- Do not turn past lock position.
- Do not turn adjustment knob when ambient temperature lower than 0°.

#### (5) Water and oil

- Care must be taken not to allow rain drops or water to wet the control unit.
- Care must be taken that condensation does not form due to sudden increase in temperature. If there is any moisture, dry control unit adequately before installing in the vehicle.
- Make sure no oil adheres to connectors.
- Do not clean the control unit using volatile solvent cleaners.

#### (6) Dropping and impact

- Do not drop the control unit or subject it to strong impact.
- Do not use upper and lower covers for the control unit which are dented.

#### (7) Control unit screws and cover

- Do not remove the upper and lower covers from the control unit.
- Do not turn the screws in the control unit main body.

## 9. ECCS CONTROL UNIT INPUT / OUTPUT SIGNALS

### 9-1 CONSULT INSPECTION VALUES

#### (1) Data monitor

**Note:** The output signal is displayed as the calculation data on console unit so the correct value will displayed even if the output circuit (harness) is inadvertently disconnected.

#### RB20E / DE / DET ENGINE

MONITORING ITEMS	DATA MONITOR			PROBLEM INSPECTION ITEM	
	CONDITION		NORMAL REFERENCE VALUE		
CAS RPM (Detected angle speed according to signals)	Tachometer set Engine running		There must be no abnormal change in speed.	Crank angle sensor system	
AIR FLOW MTR (output voltage)	After warming up engine Idling (N range, A/C OFF)		Approx. 0.8 ~ 1.5V	Air flow meter system	
ENG TEMP SEN (engine temperature)	After warming up engine		Above approx. 70°C	Engine temperature sensor system	
EXT GAS SEN (output voltage)	After warming up engine	2000rpm with no load	Changes between 0 ~ 0.3V and 0.6 ~ 1V	Exhaust gas sensor system Intake system air leak or air intake injector system	
EXT GAS SEN (RICH / LEAN)			RICH, LEAN repeats 5 times or more in 10 seconds		
CAR SPEED SEN (vehicle speed signal)	While driving or with drive wheels turning		Should generally conform to speedmeter display	Vehicle speed sensor system	
BATTERY VOLT	Ignition switch ON Engine stopped		11 ~ 14V	Battery ECCS control unit power system	
THROTTLE SEN (output voltage)	Ignition switch ON Engine stopped	Throttle fully closed	0.5	Throttle sensor adjustment Throttle sensor system	
		Throttle fully open	4.0		
INJ PULSE (injection pulse width) NOTE: 1/16 display for RB20E	After warming up engine	Idling (N range, A/C OFF)	Reference	2 ~ 3 msec	Air flow meter system Intake system air leaks or air suction (entire input) Input signal system (entire)
		2000rpm with no load		2 ~ 3 msec	
IGN TIMING	After warming up engine	Idling (N range, A/C OFF)	M/T15°, A/T20°	Air flow meter system	
		2000rpm with no load	Advance greater than 10° angle compared to idle position		
AAC VALVE	After warming up engine	Idling (N range, A/C OFF)	Approx. 20 ~ 40%	IAS adjustment AAC valve system	
		2000rpm with no load	Approx. 30 ~ 50%		
A/F ALPHA (air-fuel ratio feedback correction coefficient)	After warming up engine 2000rpm with no load		75 ~ 125%	Air flow meter system Injector system Canister (purge) inspection Intake system air leak or air suction	
START SIGNAL	Ignition switch ON Engine stopped	"START"	ON	Starter SW system	
		"OFF"	OFF		
IDLE SW	Ignition switch ON Engine stopped	Throttle fully closed	ON	Throttle sensor system	
		Throttle fully open	OFF		
AIR COND SIG	Idle	A/C SW ON	ON	Air conditioner SW system	
		A/C SW OFF	OFF		
NEUTRAL SW		N or P range	ON	Neutral SW system	
		Not N or P	OFF		
PW/ST SIGNAL		Steering	ON	Power steering SW system	
		Steering neutral	OFF		
FUEL PUMP RELAY	IGN SW ON	Stop	OFF	Fuel pump system	
		rev	ON		
AIR CONDITIONER RELAY	Idling	A/C ON	ON	Air conditioner relay system	
		A/C OFF	OFF		
	When accel 5 sec interval	A/C ON	OFF		

ECCS C U INPUT OUTPUT SIGNALS

RB20E / DE / DET ENGINE

(2) Active test

SET ITEM	ACTIVE TEST		JUDGEMENT AND INSPECTION ITEM
	CONDITION	ACTIVE TEST DESCRIPTION	
ENGINE TEMPERATURE	Problem occurrence condition	Set engine temperature high or low. <b>Caution:</b> Do not set extreme values as this can cause spark plug burning.	Perform following inspections to check if problem is solved. <u>Eliminate:</u> Engine temperature sensor system Injector system Air flow meter, exhaust gas sensor system <u>Not eliminated:</u> Other item inspection
FUEL INJECTION	Problem occurrence condition	Set the air-fuel ratio rich or lean. <b>Caution:</b> Do not set extreme values as this may damage engine or catalytic converter.	Perform following inspections to check if problem is solved. <u>Eliminate:</u> Exhaust gas sensor system Air flow meter, engine temperature sensor system Injector system <u>Not eliminated:</u> Other item inspection
IGNITION TIMING	Problem occurrence condition	Delay ignition timing. <b>Caution:</b> Do not set extreme values as this may damage engine or catalytic converter.	Perform following inspections to check if problem is solved. <u>Eliminate:</u> Ignition timing adjustment Detonation sensor system <u>Not eliminated:</u> Other item inspection
AAC VALVE OPENING	Engine running	Increase control duty ratio. The engine speed should increase. Decrease control duty ratio. The engine speed should decrease.	If the condition described on left can not be verified, check AAC valve system
FUEL PUMP RELAY	Ignition switch ON Engine stop	Turn ignition switch ON, OFF and ON so pump operation makes a sound. The fuel pressure will rise. <b>Caution:</b> Do not perform this operation except under conditions described on left.	If the condition described on left can not be verified, check relay system of fuel pump and fuel pump system
SELF-LEARNING CONT	The air-fuel ratio feedback correction coefficient learning factor is cleared.		

9-2 OSCILLOSCOPE & CIRCUIT TESTER INSPECTION VALUE (RB20E ENGINE)						
Terminal No.	Signal name	Circuit	At idle		At Approx. 2,500 rpm	
			Standard	Memo	Standard	Memo
3	Air flow meter intake air quantity signal		Approx. 1V		Approx. 1.5V	
5	Engine temperature sensor signal		Engine temperature 80°C: Approx. 1V Engine temperature 20°C: Approx. 3V		Engine temperature 80°C: Approx. 1V Engine temperature 20°C: Approx. 3V	
6	Exhaust gas sensor signal		Approx. 0 ~ 1V		Defects between 0 ~ Approx. 1V	
7	Throttle sensor signal (Input)		Approx. 0.5V		0.5 ~ 1V (Battery voltage will increase when acceleration pedal is pressed)	
9	Crank angle sensor 120° signal		0.3 ~ 0.7V		0.3 ~ 0.7V	
10	Crank angle sensor 1° signal		2 ~ 3V		2 ~ 3V	

ECCS C/U INPUT/OUTPUT SIGNALS

RB20E ENGINE

RB20E ENGINE

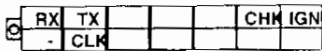
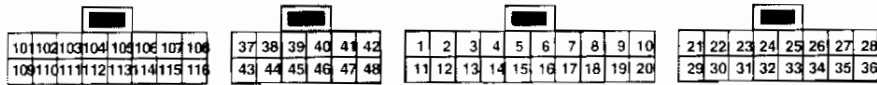

Terminal No.	Signal name	Circuit	At idle		At Approx. 2,500 rpm	
			Standard	Memo	Standard	Memo
13	Monitor & check lamp (red lamp)		Lamp not lit: Power voltage Lamp is lit: Approx. 0V		Lamp not lit: Power voltage Lamp is lit: Approx. 0V	
15	Intake air quantity output signal (To A/T C/U)		Approx. 1V		Approx. 1.5V	
16	Detonation sensor signal		Approx. 4V		Approx. 4V	
17	Throttle opening output signal		Approx. 0.5V		0.5 ~ 1V (Battery voltage will increase when acceleration pedal is pressed)	
21	Vehicle speed sensor signal		D range (or 1st) with rear wheels jacked up: 0.5 ~ 1.5V The value actually deflects between 0 and 5V. However, it appears to deflect around 1V according to vehicle speed.		D range (or 1st) with rear wheels jacked up: 0.5 ~ 1.5V The value actually deflects between 0 and 5V. However, it appears to deflect around 1V according to vehicle speed.	
22	Throttle valve switch (Idle contact point)		Approx. 10V		0V when accelerator is pressed	



ECCS C/U INPUT/OUTPUT SIGNALS

RB20E ENGINE

RB20E ENGINE																																																																																																				
<div style="display: flex; justify-content: space-around; align-items: flex-start;"> <div style="text-align: center;"> <table border="1" style="margin-bottom: 5px;"> <tr><td>101</td><td>102</td><td>103</td><td>104</td><td>105</td><td>106</td><td>107</td><td>108</td></tr> <tr><td>109</td><td>110</td><td>111</td><td>112</td><td>113</td><td>114</td><td>115</td><td>116</td></tr> </table> <table border="1" style="margin-bottom: 5px;"> <tr><td>37</td><td>38</td><td>39</td><td>40</td><td>41</td><td>42</td></tr> <tr><td>43</td><td>44</td><td>45</td><td>46</td><td>47</td><td>48</td></tr> </table> <table border="1" style="margin-bottom: 5px;"> <tr><td>1</td><td>2</td><td>3</td><td>4</td><td>5</td><td>6</td><td>7</td><td>8</td><td>9</td><td>10</td></tr> <tr><td>11</td><td>12</td><td>13</td><td>14</td><td>15</td><td>16</td><td>17</td><td>18</td><td>19</td><td>20</td></tr> </table> <table border="1" style="margin-bottom: 5px;"> <tr><td>21</td><td>22</td><td>23</td><td>24</td><td>25</td><td>26</td><td>27</td><td>28</td></tr> <tr><td>29</td><td>30</td><td>31</td><td>32</td><td>33</td><td>34</td><td>35</td><td>36</td></tr> </table> </div> <div style="margin-top: 10px;"> <table border="1" style="margin-right: 10px;"> <tr><td>RX</td><td>TX</td><td></td><td></td><td></td><td></td><td></td><td></td><td></td><td></td></tr> <tr><td>-</td><td>CLK</td><td></td><td></td><td></td><td></td><td></td><td></td><td></td><td></td></tr> </table> <table border="1"> <tr><td>CHK</td><td>IGN</td><td></td><td></td><td></td><td></td><td></td><td></td><td></td><td></td></tr> </table> </div> </div>							101	102	103	104	105	106	107	108	109	110	111	112	113	114	115	116	37	38	39	40	41	42	43	44	45	46	47	48	1	2	3	4	5	6	7	8	9	10	11	12	13	14	15	16	17	18	19	20	21	22	23	24	25	26	27	28	29	30	31	32	33	34	35	36	RX	TX									-	CLK									CHK	IGN								
101	102	103	104	105	106	107	108																																																																																													
109	110	111	112	113	114	115	116																																																																																													
37	38	39	40	41	42																																																																																															
43	44	45	46	47	48																																																																																															
1	2	3	4	5	6	7	8	9	10																																																																																											
11	12	13	14	15	16	17	18	19	20																																																																																											
21	22	23	24	25	26	27	28																																																																																													
29	30	31	32	33	34	35	36																																																																																													
RX	TX																																																																																																			
-	CLK																																																																																																			
CHK	IGN																																																																																																			
Terminal No.	Signal name	Circuit	At idle		At Approx. 2,500 rpm																																																																																															
			Standard	Memo	Standard	Memo																																																																																														
23	Ignition switch (START signal)		0V (Ignition switch at START: Power voltage)		0V																																																																																															
24	Neutral switch signal		N or P range: 0V Other than N or P range: Approx. 6V		N or P range: 0V Other than N or P range: Approx. 6V																																																																																															
25	Ignition switch (ON signal)		Power voltage		Power voltage																																																																																															
26	Throttle sensor signal (Power supply)		5V		5V																																																																																															
27	Control unit power supply		Power voltage		Power voltage																																																																																															
29	Air conditioner switch signal		Air conditioner OFF: Power voltage Air conditioner ON: Approx. 0V		Air conditioner OFF: Power voltage Air conditioner ON: Approx. 0V																																																																																															

ECCS C/U INPUT/OUTPUT SIGNALS

RB20E ENGINE

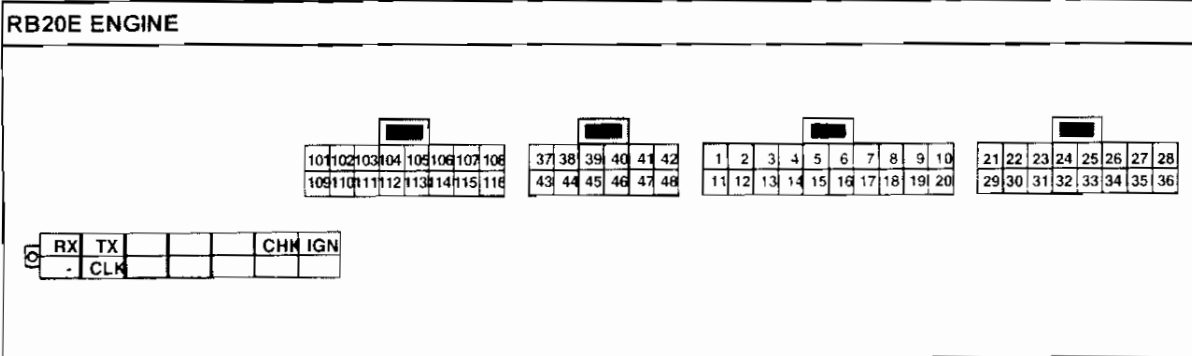

Terminal No.	Signal name	Circuit	At idle		At Approx. 2,500 rpm	
			Standard	Memo	Standard	Memo
32	Throttle valve switch (Power supply)		Power voltage		Power voltage	
37	Power transistor control signal		0.2 ~ 0.3V 		Approx. 1V 	
38	Power steering switch signal		Power steering ON: 0V Power steering OFF: Approx. 5V		Power steering ON: 0V Power steering OFF: Approx. 5V	
39	Tachometer signal (Ignition coil primary signal detection)		Power voltage 		Approx. 10V 	
40	ECCS relay		Approx. 1V (Ignition switch OFF: Power voltage)		0V	
43	Tachometer engine rev signal		Approx. 1V 		Approx. 3V 	

ECCS C/U INPUT/OUTPUT SIGNALS

RB20E ENGINE

RB20E ENGINE																																																																																				
<div style="display: flex; justify-content: space-around; align-items: flex-start;"> <div style="border: 1px solid black; padding: 2px;"> <table border="1" style="font-size: 8px;"> <tr><td>101</td><td>102</td><td>103</td><td>104</td><td>105</td><td>106</td><td>107</td><td>108</td></tr> <tr><td>109</td><td>110</td><td>111</td><td>112</td><td>113</td><td>114</td><td>115</td><td>116</td></tr> </table> </div> <div style="border: 1px solid black; padding: 2px;"> <table border="1" style="font-size: 8px;"> <tr><td>37</td><td>38</td><td>39</td><td>40</td><td>41</td><td>42</td></tr> <tr><td>43</td><td>44</td><td>45</td><td>46</td><td>47</td><td>48</td></tr> </table> </div> <div style="border: 1px solid black; padding: 2px;"> <table border="1" style="font-size: 8px;"> <tr><td>1</td><td>2</td><td>3</td><td>4</td><td>5</td><td>6</td><td>7</td><td>8</td><td>9</td><td>10</td></tr> <tr><td>11</td><td>12</td><td>13</td><td>14</td><td>15</td><td>16</td><td>17</td><td>18</td><td>19</td><td>20</td></tr> </table> </div> <div style="border: 1px solid black; padding: 2px;"> <table border="1" style="font-size: 8px;"> <tr><td>21</td><td>22</td><td>23</td><td>24</td><td>25</td><td>26</td><td>27</td><td>28</td></tr> <tr><td>29</td><td>30</td><td>31</td><td>32</td><td>33</td><td>34</td><td>35</td><td>36</td></tr> </table> </div> </div> <div style="border: 1px solid black; padding: 2px; margin-top: 5px;"> <table border="1" style="font-size: 8px;"> <tr><td>RX</td><td></td><td></td><td></td><td></td><td>CHK</td><td>IGN</td></tr> <tr><td>-</td><td>CLK</td><td></td><td></td><td></td><td></td><td></td></tr> </table> </div>							101	102	103	104	105	106	107	108	109	110	111	112	113	114	115	116	37	38	39	40	41	42	43	44	45	46	47	48	1	2	3	4	5	6	7	8	9	10	11	12	13	14	15	16	17	18	19	20	21	22	23	24	25	26	27	28	29	30	31	32	33	34	35	36	RX					CHK	IGN	-	CLK					
101	102	103	104	105	106	107	108																																																																													
109	110	111	112	113	114	115	116																																																																													
37	38	39	40	41	42																																																																															
43	44	45	46	47	48																																																																															
1	2	3	4	5	6	7	8	9	10																																																																											
11	12	13	14	15	16	17	18	19	20																																																																											
21	22	23	24	25	26	27	28																																																																													
29	30	31	32	33	34	35	36																																																																													
RX					CHK	IGN																																																																														
-	CLK																																																																																			
Terminal No.	Signal name	Circuit	At idle		At Approx. 2,500 rpm																																																																															
			Standard	Memo	Standard	Memo																																																																														
44	Engine A/T total control input signal (DT1)		Approx. 10V		Approx. 10V																																																																															
45	Engine A/T total control input signal (DT2)																																																																																			
46	Air conditioner relay		Air conditioner OFF: Power voltage Air conditioner ON: 0V		Air conditioner OFF: Power voltage Air conditioner ON: 0V																																																																															
47	Engine A/T total control output signal (DT3)		0V		0V																																																																															
101 103 105 110 112 114	Injector control signal		Almost power voltage		Almost power voltage																																																																															
104	Fuel pump relay		0V		0V																																																																															

ECCS C.U INPUT/OUTPUT SIGNALS

RB20E ENGINE

RB20E ENGINE

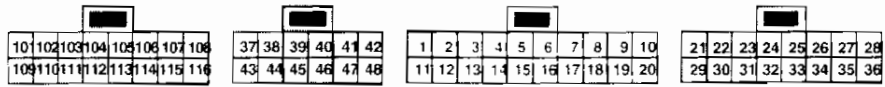

Terminal No.	Signal name	Circuit	At idle		At Approx. 2,500 rpm	
			Standard	Memo	Standard	Memo
113	AAC valve control signal		Cold: 6 ~ 7V Warm: 8 ~ 10V 		Approx. 4 ~ 5V 	

9-2 OSCILLOSCOPE & CIRCUIT TESTER INSPECTION VALUE (RB20DE / DET ENGINE)

101	102	103	104	105	106	107	108	1	2	3	4	5	6	7	8	9	10		21	22	23	24	25	26	27	28	29	30	41	42	43	44	45	46	47	48	49	50
109	110	111	112	113	114	115	116	11	12	13	14	15	16	17	18	19	20		31	32	33	34	35	36	37	38	39	40	51	52	53	54	55	56	57	58	59	60

RX	TX					CHK	IGN
-	CLK						

Terminal No.	Signal name	Circuit	At idle		At Approx. 2,500 rpm	
			Standard	Memo	Standard	Memo
18	Fuel pump relay		0V		0V	
19	Power steering switch signal		Power steering ON: 0V Power steering OFF: 5V		Power steering ON: 0V Power steering OFF: 5V	
23 24	Detonation sensor signal		Approx. 4V		Approx. 4V	
27	Air flow meter (Intake air quantity signal)		Approx. 1V		Approx. 1.5V	
28	Engine temperature sensor signal		Engine temperature 80°C: Approx. 1V Engine temperature 20°C: Approx. 3V		Engine temperature 80°C: Approx. 1V Engine temperature 20°C: Approx. 3V	
29	Exhaust gas sensor signal		Approx. 1V		defect between 0 ~ approx. 1V	



RB20DE / DET ENGINE																																																																																																	
<table border="1" style="width:100%; border-collapse: collapse;"> <tr> <td>101</td><td>102</td><td>103</td><td>104</td><td>105</td><td>106</td><td>107</td><td>108</td><td>1</td><td>2</td><td>3</td><td>4</td><td>5</td><td>6</td><td>7</td><td>8</td><td>9</td><td>10</td><td style="background-color: black;"></td><td>21</td><td>22</td><td>23</td><td>24</td><td>25</td><td>26</td><td>27</td><td>28</td><td>29</td><td>30</td><td>41</td><td>42</td><td>43</td><td>44</td><td>45</td><td>46</td><td>47</td><td>48</td><td>49</td><td>50</td> </tr> <tr> <td>109</td><td>110</td><td>111</td><td>112</td><td>113</td><td>114</td><td>115</td><td>116</td><td>11</td><td>12</td><td>13</td><td>14</td><td>15</td><td>16</td><td>17</td><td>18</td><td>19</td><td>20</td><td></td><td>31</td><td>32</td><td>33</td><td>34</td><td>35</td><td>36</td><td>37</td><td>38</td><td>39</td><td>40</td><td>51</td><td>52</td><td>53</td><td>54</td><td>55</td><td>56</td><td>57</td><td>58</td><td>59</td><td>60</td> </tr> </table> <table border="1" style="width:100%; border-collapse: collapse;"> <tr> <td>RX</td><td>TX</td><td></td><td></td><td></td><td>CHK</td><td>IGN</td> </tr> <tr> <td>-</td><td>CLK</td><td></td><td></td><td></td><td></td><td></td> </tr> </table>						101	102	103	104	105	106	107	108	1	2	3	4	5	6	7	8	9	10		21	22	23	24	25	26	27	28	29	30	41	42	43	44	45	46	47	48	49	50	109	110	111	112	113	114	115	116	11	12	13	14	15	16	17	18	19	20		31	32	33	34	35	36	37	38	39	40	51	52	53	54	55	56	57	58	59	60	RX	TX				CHK	IGN	-	CLK					
101	102	103	104	105	106	107	108	1	2	3	4	5	6	7	8	9	10		21	22	23	24	25	26	27	28	29	30	41	42	43	44	45	46	47	48	49	50																																																											
109	110	111	112	113	114	115	116	11	12	13	14	15	16	17	18	19	20		31	32	33	34	35	36	37	38	39	40	51	52	53	54	55	56	57	58	59	60																																																											
RX	TX				CHK	IGN																																																																																											
-	CLK																																																																																																
Terminal No.	Signal name	Circuit	At idle		At Approx. 2,500 rpm																																																																																												
			Standard	Memo	Standard	Memo																																																																																											
41	Crank angle sensor 120° signal		0.3 ~ 0.7		0.3 ~ 0.7																																																																																												
42	Crank angle sensor 1° signal		2 ~ 3 V		2 ~ 3V																																																																																												
43	Ignition switch (START signal)		0V (Ignition switch in "START" : Power voltage)		0V (Ignition switch in "START" : Power voltage)																																																																																												
44	Neutral switch signal		N or P range: 0V Other than N or P range: 4 ~ 5V		N or P range: 0V Other than N or P range: 4 ~ 5V																																																																																												
46	Air conditioner switch signal		Air conditioner OFF: Power voltage Air conditioner ON: 0V		Air conditioner OFF: Power voltage Air conditioner ON: 0V																																																																																												
48	Throttle sensor (Power supply)		5V		5V																																																																																												







### 9-3 ECCS CONTROL UNIT OPERATION CAUTIONS

#### (1) Control unit equipment

- Never install a control unit that is not specified for your vehicle.
- Do not apply excessive force to the installation bracket.

#### (2) Connector removal and installation

- When removing and installing connectors, do not bend or apply unnecessary force and observe following points:

##### 1. Connector removal

- Turn ignition switch OFF and ECCS relay OFF before removing connectors.
- Hold connector firmly to disconnect without applying force to harness.
- Do not use a screwdriver or similar tool to loosen the connector lock.

##### 2. Connector installation

- Turn ignition switch OFF.
- Make sure pins are not bent or control unit connector and then connect securely.
- Tighten bolts securely until injector surface reaches orange colour indicator of connector and surface is even.

#### (3) Control unit power

- Never make a reverse connection to the battery.
- Use battery voltage in 10 - 16V range.

#### (4) Idle speed adjustment knob

- Do not turn past lock position.
- Do not turn adjustment knob when ambient temperature lower than 0°C.

#### (5) Water and oil

- Care must be taken not to allow rain drops or water to wet the control unit.
- Care must be taken that condensation does not form due to sudden increase in temperature. If there is any moisture, dry control unit adequately before installing in the vehicle.
- Make sure no oil adheres to connectors.
- Do not clean the control unit using volatile solvent cleaners.

#### (6) Dropping and impact

- Do not drop the control unit or subject it to strong impact.
- Do not use upper and lower covers for the control unit which are dented.

#### (7) Control unit screws and cover

- Do not remove the upper and lower covers from the control unit.
- Do not turn the screws in the control unit main body.

## CA18i ENGINE

## 9. ECCS CONTROL UNIT INPUT / OUTPUT SIGNALS

## 9-1 CONSULT INSPECTION VALUES

## (1) Data monitor

Note: The output signal is displayed as the calculation data on console unit so the correct value will displayed even if the output circuit (harness) is inadvertently disconnected.

## CA18i ENGINE

MONITORING ITEMS	DATA MONITOR			PROBLEM INSPECTION ITEM	
	CONDITION		NORMAL REFERENCE VALUE		
CAS RPM (Detected angle speed according to signals)	Tachometer set Engine running		There must be no abnormal change in speed	Crank angle sensor system	
ENG TEMP SEN (engine temperature)	After warming up engine		Above approx. 70°C	Engine temperature sensor system	
EXT GAS SEN (output voltage)	After warming up engine	2000rpm with no load	Changes between 0 ~ 0.3V and 0.6 ~ 1V	Exhaust gas sensor system Intake system air leak or air intake injector system	
EXT GAS SEN (RICH / LEAN)			RICH. LEAN repeats 5 times or more in 10 seconds		
CAR SPEED SEN (vehicle speed signal)	While driving or with drive wheels turning		Should generally conform to speedmeter display	Vehicle speed sensor system	
BATTERY VOLT	Ignition switch ON Engine stopped		11 ~ 14V	Battery ECCS control unit power system	
THROTTLE SEN (output voltage)	Ignition switch ON Engine stopped	Throttle fully closed	1.0	Throttle sensor adjustment Throttle sensor system	
		Throttle fully open	5.0		
THROTTLE SEN (2) (output voltage)		Throttle fully closed	0.6		
		Throttle fully open	4.5		
INT/A TEMP SEN (intake temperature sensor output)	After warming up engine		Intake air temperature is displayed	Intake temperature sensor system	
INJ PULSE (injection pulse width)	After warming up engine	Idling (N range, A/C OFF)	Reference	1 ~ 2 msec	Air flow meter system Intake system air leaks or air suction (entire input) Input signal system (entire)
		2000rpm with no load		1 ~ 2 msec	
IGN TIMING	After warming up engine	Idling (N range, A/C OFF)	M/T15°, A/T20°	Air flow meter system	
		2000rpm with no load	Advance greater than 10° angle compared to idle position		
A/F ALPHA (air-fuel ratio feedback correction coefficient)	After warming up engine 2000rpm with no load		75 ~ 125%	Air flow meter system Injector system Canister (purge) inspection Intake system air leak or air suction	
START SIGNAL	Ignition switch ON Engine stopped	"START"	ON	Starter SW system	
		"OFF"	OFF		
IDLE SW	Ignition switch ON Engine stopped	Throttle fully closed	ON	Throttle sensor system	
		Throttle fully open	OFF		
AIR COND SIG	Idle	A/C SW ON	ON	Air conditioner SW system	
		A/C SW OFF	OFF		
NEUTRAL SW		N or P range	ON	Neutral SW system	
		Not N or P	OFF		
PW/ST SIGNAL		Steering	ON	Power steering SW system	
		Steering neutral	OFF		
W/G CONT SW	Idle	Head lamp, heater fan, rear defogger SW ON	ON		
		Above SW OFF	OFF		
FICD SW	Ignition switch ON	A/C ON	ON	FICD input system	
		A/C OFF	OFF		
PTC HEATER	Rewing	Eng temp cold	ON	PTC heater input system	
		Eng temp Hot	OFF		
FUEL PUMP RELAY	IGN switch ON	Stop	OFF	Fuel pump system	
		rev	ON		
AIR CONDITIONER RELAY	Idle	A/C ON	OFF	Air conditioner system	
		A/C OFF	OFF		

## (2) Active test

SET ITEM	ACTIVE TEST		JUDGEMENT AND INSPECTION ITEM
	CONDITION	ACTIVE TEST DESCRIPTION	
ENGINE TEMPERATURE	Problem occurrence condition	Set engine temperature high or low. <b>Caution:</b> Do not set extreme values as this can cause spark plug burning.	Perform following inspections to check if problem is solved. <u>Eliminate:</u> Engine temperature sensor system Injector system Air flow meter, exhaust gas sensor system <u>Not eliminated:</u> Other item inspection
FUEL INJECTION	Problem occurrence condition	Set the air-fuel ratio rich or lean. <b>Caution:</b> Do not set extreme values as this may damage engine or catalytic converter.	Perform following inspections to check if problem is solved. <u>Eliminate:</u> Exhaust gas sensor system Air flow meter, engine temperature sensor system Injector system <u>Not eliminated:</u> Other item inspection
IGNITION TIMING	Problem occurrence condition	Delay ignition timing. <b>Caution:</b> Do not set extreme values as this may damage engine or catalytic converter.	Perform following inspections to check if problem is solved. <u>Eliminate:</u> Ignition timing adjustment Detonation sensor system <u>Not eliminated:</u> Other item inspection
IDLE CORRECTION S/V	After engine warm up Idling (N range, A/C OFF)	Turn ignition switch ON and OFF. The idle rev will change. <b>Caution:</b> Do not perform this operation except under condition described on left.	If the condition described on left can not be verified, check idle correction solenoid system
FICD S/V	After engine warm up Idling (N range, A/C OFF)	Turn ignition switch ON and OFF. The idle rev will increase at approx 200rpm <b>Caution:</b> Do not perform this operation except under condition described on left.	If the condition described on left can not be verified, check FICD solenoid system
FUEL PUMP RELAY	Ignition switch ON Engine stop	Turn ignition switch ON, OFF and ON so pump operation makes a sound. The fuel pressure will rise. <b>Caution:</b> Do not perform this operation except under conditions described on left.	If the condition described on left can not be verified, check relay system of fuel pump and fuel pump system
SELF-LEARNING CONT	The air-fuel ratio feedback correction coefficient learning factor is cleared.		

9-2 OSCILLOSCOPE & CIRCUIT TESTER INSPECTION VALUE (CA18i ENGINE)

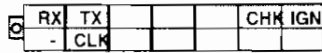
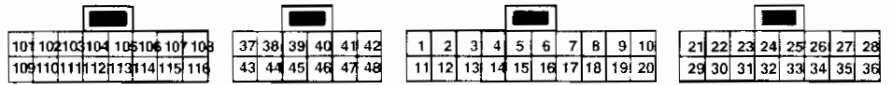

Terminal No.	Signal name	Circuit	At idle		At Approx. 2,500 rpm	
			Standard	Memo	Standard	Memo
3	Throttle sensor signal 1		Approx. 1V		Approx. 1V ~ 5V (Voltage will increase when accelerator pedal is pressed)	
5	Engine temperature sensor signal		Engine temperature 80°C: 1V Engine temperature 20°C: 3V		Engine temperature 80°C: 1V Engine temperature 20°C: 3V	
6	Exhaust gas sensor signal		Defect between approx. 0 ~ 1V 		Defect between approx. 0 ~ 1V 	
7	Throttle sensor signal 2		Approx. 0.6V		Approx. 0.6V ~ 4.5V (Voltage increase when accelerator pedal is pressed)	
9 19	Crank angle sensor 180° signal		Approx. 0.3 ~ 0.7V 		Approx. 0.3 ~ 0.7V 	
10 20	Crank angle sensor 1° signal		Approx. 2 ~ 3V 		Approx. 2 ~ 3V 	

ECCS C/U INPUT/OUTPUT SIGNALS

CA18i ENGINE

CA18i ENGINE

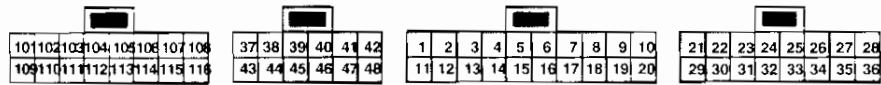

Terminal No.	Signal name	Circuit	At idle		At Approx. 2,500 rpm	
			Standard	Memo	Standard	Memo
13	Monitor & check lamp (red lamp)		Lamp not lit: Power voltage Lamp lit: Approx. 0V		Lamp not lit: Power voltage Lamp lit: Approx. 0V	
21	Vehicle speed sensor signal				Approx. 1 ~ 5V (Cycle will get shorter when vehicle speed is increased)	
23	Ignition switch "START" signal		0V (Ignition switch in START: Power voltage)		0V (Ignition switch in START: Power voltage)	
24	Neutral switch signal		N or P range: 0V Other than N or P range: 6 ~ 7V		N or P range: 0V Other than N or P range: 6 ~ 7V	
27	ECCS control unit power supply		Power voltage		Power voltage	
29	Air conditioner switch signal		Air conditioner OFF: Power voltage Air conditioner ON: 0V		Air conditioner OFF: Power voltage Air conditioner ON: 0V	

CA18i ENGINE																																																																																		
<div style="display: flex; justify-content: space-around; align-items: center;"> <div style="border: 1px solid black; padding: 2px;"> <table border="1" style="font-size: 8px;"> <tr><td>101</td><td>102</td><td>103</td><td>104</td><td>105</td><td>106</td><td>107</td><td>108</td></tr> <tr><td>109</td><td>110</td><td>111</td><td>112</td><td>113</td><td>114</td><td>115</td><td>116</td></tr> </table> </div> <div style="border: 1px solid black; padding: 2px;"> <table border="1" style="font-size: 8px;"> <tr><td>37</td><td>38</td><td>39</td><td>40</td><td>41</td><td>42</td></tr> <tr><td>43</td><td>44</td><td>45</td><td>46</td><td>47</td><td>48</td></tr> </table> </div> <div style="border: 1px solid black; padding: 2px;"> <table border="1" style="font-size: 8px;"> <tr><td>1</td><td>2</td><td>3</td><td>4</td><td>5</td><td>6</td><td>7</td><td>8</td><td>9</td><td>10</td></tr> <tr><td>11</td><td>12</td><td>13</td><td>14</td><td>15</td><td>16</td><td>17</td><td>18</td><td>19</td><td>20</td></tr> </table> </div> <div style="border: 1px solid black; padding: 2px;"> <table border="1" style="font-size: 8px;"> <tr><td>21</td><td>22</td><td>23</td><td>24</td><td>25</td><td>26</td><td>27</td><td>28</td></tr> <tr><td>29</td><td>30</td><td>31</td><td>32</td><td>33</td><td>34</td><td>35</td><td>36</td></tr> </table> </div> </div> <div style="border: 1px solid black; padding: 2px; margin-top: 5px;"> <table border="1" style="font-size: 8px;"> <tr><td>RX</td><td>TX</td><td></td><td></td><td>CHK</td><td>IGN</td></tr> <tr><td>-</td><td>CLK</td><td></td><td></td><td></td><td></td></tr> </table> </div>							101	102	103	104	105	106	107	108	109	110	111	112	113	114	115	116	37	38	39	40	41	42	43	44	45	46	47	48	1	2	3	4	5	6	7	8	9	10	11	12	13	14	15	16	17	18	19	20	21	22	23	24	25	26	27	28	29	30	31	32	33	34	35	36	RX	TX			CHK	IGN	-	CLK				
101	102	103	104	105	106	107	108																																																																											
109	110	111	112	113	114	115	116																																																																											
37	38	39	40	41	42																																																																													
43	44	45	46	47	48																																																																													
1	2	3	4	5	6	7	8	9	10																																																																									
11	12	13	14	15	16	17	18	19	20																																																																									
21	22	23	24	25	26	27	28																																																																											
29	30	31	32	33	34	35	36																																																																											
RX	TX			CHK	IGN																																																																													
-	CLK																																																																																	
Terminal No.	Signal name	Circuit	At idle		At Approx. 2,500 rpm																																																																													
			Standard	Memo	Standard	Memo																																																																												
30	Intake air temperature sensor signal		Cold: Approx. 1.5V Warm: Approx. 0.8V		Cold: Approx. 1.5V Warm: Approx. 0.8V																																																																													
31	Power steering signal		Power steering ON: 0V Power steering OFF: Approx. 8V		Power steering ON: 0V Power steering OFF: Approx. 8V																																																																													
37	Power transistor control signal (IN)		Approx. 0.5V		Approx. 1V																																																																													
38	Power transistor control signal (EX)		Approx. 0.5V		Approx. 1V																																																																													
39	Ignition primary signal		Approx. 11V ~ 12V		Approx. 10V ~ 11V																																																																													
40	ECCS relay		0V (Ignition switch OFF: Power voltage)		0V																																																																													

ECCS C/U INPUT/OUTPUT SIGNALS

CA18i ENGINE

CA18i ENGINE

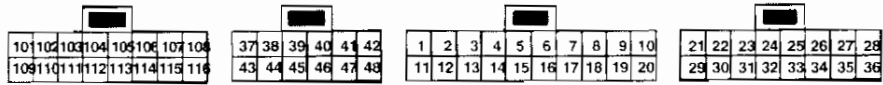

Terminal No.	Signal name	Circuit	At idle		At Approx. 2,500 rpm	
			Standard	Memo	Standard	Memo
41	Fuel injector pulse monitor signal (Ti monitor)		Power voltage 		Lower than power voltage 	
43	Light switch signal		Switch ON: Power voltage Switch OFF: 0V		Switch ON: Power voltage Switch OFF: 0V	
45	Heater fan switch signal		Switch ON: Power voltage Switch OFF: 0V		Switch ON: Power voltage Switch OFF: 0V	
46	Rear defogger switch signal		Switch ON: Power voltage Switch OFF: 0V		Switch ON: Power voltage Switch OFF: 0V	
101 110	Injector control signal		Power voltage 		Lower than power voltage 	
102	Air conditioner relay signal		Air conditioner ON: Power voltage Air conditioner OFF: 0V		Air conditioner ON: Power voltage Air conditioner OFF: 0V	



CA18i ENGINE																																																																																		
<div style="display: flex; justify-content: space-around; align-items: center;"> <div style="border: 1px solid black; padding: 2px;"> <table border="1" style="font-size: 8px;"> <tr><td>101</td><td>102</td><td>103</td><td>104</td><td>105</td><td>106</td><td>107</td><td>108</td></tr> <tr><td>109</td><td>110</td><td>111</td><td>112</td><td>113</td><td>114</td><td>115</td><td>116</td></tr> </table> </div> <div style="border: 1px solid black; padding: 2px;"> <table border="1" style="font-size: 8px;"> <tr><td>37</td><td>38</td><td>39</td><td>40</td><td>41</td><td>42</td></tr> <tr><td>43</td><td>44</td><td>45</td><td>46</td><td>47</td><td>48</td></tr> </table> </div> <div style="border: 1px solid black; padding: 2px;"> <table border="1" style="font-size: 8px;"> <tr><td>1</td><td>2</td><td>3</td><td>4</td><td>5</td><td>6</td><td>7</td><td>8</td><td>9</td><td>10</td></tr> <tr><td>11</td><td>12</td><td>13</td><td>14</td><td>15</td><td>16</td><td>17</td><td>18</td><td>19</td><td>20</td></tr> </table> </div> <div style="border: 1px solid black; padding: 2px;"> <table border="1" style="font-size: 8px;"> <tr><td>21</td><td>22</td><td>23</td><td>24</td><td>25</td><td>26</td><td>27</td><td>28</td></tr> <tr><td>29</td><td>30</td><td>31</td><td>32</td><td>33</td><td>34</td><td>35</td><td>36</td></tr> </table> </div> </div> <div style="border: 1px solid black; padding: 2px; margin-top: 5px;"> <table border="1" style="font-size: 8px;"> <tr><td>RX</td><td>TX</td><td></td><td></td><td>CHM</td><td>IGN</td></tr> <tr><td>-</td><td>CLK</td><td></td><td></td><td></td><td></td></tr> </table> </div>							101	102	103	104	105	106	107	108	109	110	111	112	113	114	115	116	37	38	39	40	41	42	43	44	45	46	47	48	1	2	3	4	5	6	7	8	9	10	11	12	13	14	15	16	17	18	19	20	21	22	23	24	25	26	27	28	29	30	31	32	33	34	35	36	RX	TX			CHM	IGN	-	CLK				
101	102	103	104	105	106	107	108																																																																											
109	110	111	112	113	114	115	116																																																																											
37	38	39	40	41	42																																																																													
43	44	45	46	47	48																																																																													
1	2	3	4	5	6	7	8	9	10																																																																									
11	12	13	14	15	16	17	18	19	20																																																																									
21	22	23	24	25	26	27	28																																																																											
29	30	31	32	33	34	35	36																																																																											
RX	TX			CHM	IGN																																																																													
-	CLK																																																																																	
Terminal No.	Signal name	Circuit	At idle		At Approx. 2,500 rpm																																																																													
			Standard	Memo	Standard	Memo																																																																												
103	FICD solenoid		Air conditioner ON: 0V Air conditioner OFF: Power voltage		Air conditioner ON: 0V Air conditioner OFF: Power voltage																																																																													
104	Fuel pump relay		Approx. 0V (Power voltage for 5 sec after ignition switch is placed to ON position)		Approx. 0V																																																																													
106	PTC heater relay		PTC heater ON: Approx. 0V PTC heater OFF: Power voltage		PTC heater ON: Approx. 0V PTC heater OFF: Power voltage																																																																													
111	Idle rev correction solenoid		1. When ign sw in on 2. Engine rewing: Approx. 0V First 15 sec after engine start: Approx. 0V After 15 sec after engine start: Power voltage Any of the followings are ON (Power steering, lights, rear defogger, heater fan switch): Approx. 0V (D range for A/T)																																																																															
115	Lock up release solenoid (A/T)		Lock up released: Approx. 0V Lock up applied: Power voltage		Lock up released: Approx. 0V Lock up applied: Power voltage																																																																													

## 9. ECCS CONTROL UNIT INPUT / OUTPUT SIGNALS

### 9-1 CONSULT INSPECTION VALUES

#### (1) Data monitor

Note: The output signal is displayed as the calculation data on console unit so the correct value will displayed even if the output circuit (harness) is inadvertently disconnected.

#### RB25DE ENGINE

MONITORING ITEMS	DATA MONITOR		PROBLEM INSPECTION ITEM
	CONDITION	NORMAL REFERENCE VALUE	
CAS RPM (Detected angle speed according to signals)	Tachometer set Engine running		There must be no abnormal change in speed.
AIR FLOW MTR (output voltage)	After warming up engine Idling (N range, A/C OFF)	Idling 2000rpm without load	Approx. 1.0 ~ 1.5V
ENG TEMP SEN (engine temperature)	After warming up engine		Above approx. 70°C
EXT GAS SEN (output voltage)	After warming up engine	2000rpm with no load	Changes between 0 ~ 0.3V and 0.6 ~ 1V
EXT GAS SEN (RICH / LEAN)			RICH, LEAN repeats 5 times or more in 10 seconds
CAR SPEED SEN (vehicle speed signal)	While driving or with drive wheels turning		Should generally conform to speedmeter display
BATTERY VOLT	Ignition switch ON Engine stopped		11 ~ 14V
INJ PULSE (injection pulse width)	After warming up engine	Idling (N range, A/C OFF)	Approx. 2.0 ~ 2.8msec
		2000rpm with no load	Approx. 2.0 ~ 2.8msec
IGN TIMING	After warming up engine	Idling (N range, A/C OFF)	15°
		2000rpm with no load	Advance greater than 10° angle compared to idle position
AAC VALVE	After warming up engine	Idling (N range, A/C OFF)	Approx. 12 ~ 30%
A/F ALPHA (air-fuel ratio feedback correction coefficient)	After warming up engine 2000rpm with no load		75 ~ 125%
START SIGNAL	Ignition switch ON Engine stopped	"START"	ON
		"OFF"	OFF
IDLE SJUDGEMENT		Throttle fully closed	ON
		Throttle fully open	OFF
AIR COND SIG		A/C SW ON	ON
		A/C SW OFF	OFF
NEUTRAL SW	Idle	N or P range	ON
		Not N or P	OFF
PW/ST SIGNAL		Steering	ON
		Steering neutral	OFF
AIR CON RELAY		A/C ON	ON
		OFF	OFF
FUEL PUMP RELAY	Accel	A/C ON	OFF
		IGN SW ON	
THROTTLE SEN (output voltage)	Ignition switch ON Engine stopped	Stop	OFF
		When rev	ON
THROTTLE SEN (output voltage)	Ignition switch ON Engine stopped	Throttle fully closed	Approx. 4.0
		Throttle fully open	Approx. 0.5
POWER VOLTAGE	Display power voltage probe measurement value		
PULSE	Display pulse probe measurement value		

(2) Active test

SET ITEM	ACTIVE TEST		JUDGEMENT AND INSPECTION ITEM
	CONDITION	ACTIVE TEST DESCRIPTION	
ENGINE TEMPERATURE	Problem occurrence condition	Set engine temperature high or low. <u>Caution:</u> Do not set extreme values as this can cause spark plug burning.	Perform following inspections to check if problem is solved. <u>Eliminate:</u> Engine temperature sensor system Injector system Air flow meter, exhaust gas sensor system <u>Not eliminated:</u> Other item inspection
FUEL INJECTION	Problem occurrence condition	Set the air-fuel ratio rich or lean. <u>Caution:</u> Do not set extreme values as this may damage engine or catalytic converter.	Perform following inspections to check if problem is solved. <u>Eliminate:</u> Exhaust gas sensor system Air flow meter, engine temperature sensor system Injector system <u>Not eliminated:</u> Other item inspection
IGNITION TIMING	Problem occurrence condition	Delay ignition timing. <u>Caution:</u> Do not set extreme values as this may damage engine or catalytic converter.	Perform following inspections to check if problem is solved. <u>Eliminate:</u> Ignition timing adjustment Detonation sensor system <u>Not eliminated:</u> Other item inspection
AAC VALVE OPENING	Engine running	Increase control duty ratio. The engine speed should increase. Decrease control duty ratio. The engine speed should decrease.	If the condition described on left can not be verified, check AAC valve system.
FUEL PUMP RELAY	Ignition switch ON Engine stop	Turn ignition switch ON, OFF and ON so pump operation makes a sound. The fuel pressure will rise. <u>Caution:</u> Do not perform this operation except under conditions described on left.	If the condition described on left can not be verified, check relay system of fuel pump and fuel pump system
SELF-LEARNING CONT	The air-fuel ratio feedback correction coefficient learning factor is cleared.		
POWER BALANCE	Problem occurrence condition	Engine rev can be displayed when AAC valve opening is fixed and set injector operation is stopped. <u>Caution:</u> Do not perform this operation while driving	<u>Eliminate:</u> Injector system

ECCS C/U INPUT/OUTPUT SIGNALS

RB25DE ENGINE

9-2 OSCILLOSCOPE & CIRCUIT TESTER INSPECTION VALUE (RB25DE ENGINE)

101	102	103	104	105	106	107	108	1	2	3	4	5	6	7	8	9	10		21	22	23	24	25	26	27	28	29	30	41	42	43	44	45	46	47	48	49	50
109	110	111	112	113	114	115	116	11	12	13	14	15	16	17	18	19	20		31	32	33	34	35	36	37	38	39	40	51	52	53	54	55	56	57	58	59	60

RX	TX			CHK	IGN
-	CLK				

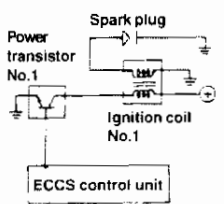
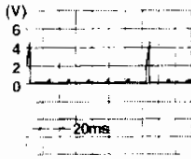
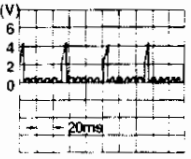
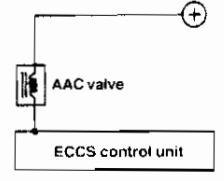
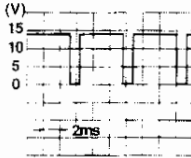
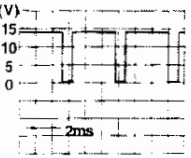
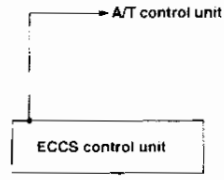
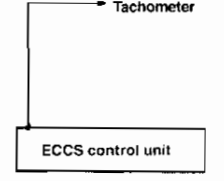
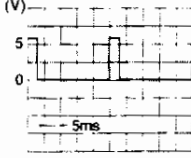
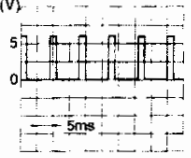
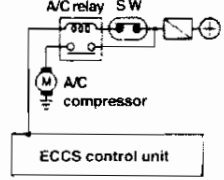
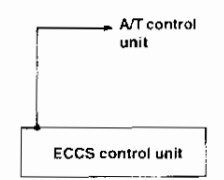
Terminal No.	Signal name	Circuit	At idle		At Approx. 2,500 rpm		
			Standard	Memo	Standard	Memo	
1 2 3 11 12 13	Power transistor control signal		0.2 ~ 0.3 V			Approx. 0.4V	
4	AAC valve control signal		Cold: 6 ~ 7V Warm: 8 ~ 10V			Approx. 5V	
5	Engine A/T total control input signal (DT1)		Approx. 10V			Approx. 10V	
7	Tachometer engine speed signal		Approx. 1V			Approx. 2.4V	
9	Air conditioner relay		Air conditioner OFF: Power voltage Air conditioner ON: Approx. 1V			Air conditioner OFF: Power voltage Air conditioner ON: Approx. 1V	
14	Engine a/T total control input signal (DT2)		Approx. 10V			Approx. 10V	

ECCS C/U INPUT/OUTPUT SIGNALS

RB25DE ENGINE

Terminal No.		Signal name	Circuit	At idle		At Approx. 2,500 rpm	
				Standard	Memo	Standard	Memo
15		Engine A/T total control output signal (DT3)		Approx. 0V		Approx. 0V	
16		ECCS relay		Approx. 1V (Ignition switch OFF: Power voltage)		Approx. 0V	
18		Fuel pump relay		0V		0V	
19		Power steering switch signal		Power steering ON 0V Power steering OFF: 5V		Power steering ON: 0V Power steering OFF: 5V	
23 24		Detonation sensor signal		Approx. 0.3V		Approx. 0.3V	
27		Air flow meter (intake air quantity signal)		Approx. 1V		Approx. 1.5V	

ECCS C/U INPUT/OUTPUT SIGNALS

RB25DE ENGINE

RB25DE ENGINE

101	102	103	104	105	106	107	108	1	2	3	4	5	6	7	8	9	10		21	22	23	24	25	26	27	28	29	30	41	42	43	44	45	46	47	48	49	50
109	110	111	112	113	114	115	116	11	12	13	14	15	16	17	18	19	20		31	32	33	34	35	36	37	38	39	40	51	52	53	54	55	56	57	58	59	60

RX	TX			CHK	IGN
-	CLK				

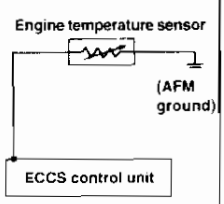
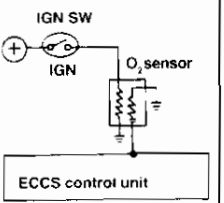
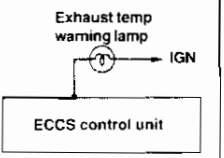
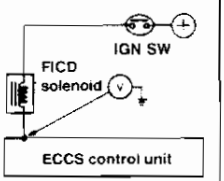
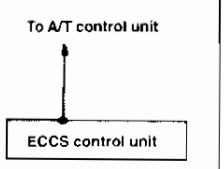
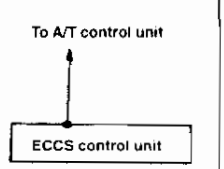
Terminal No.	Signal name	Circuit	At idle		At Approx. 2,500 rpm	
			Standard	Memo	Standard	Memo
28	Engine temperature sensor signal		Engine temperature 80°C: Approx. 1V Engine temperature 20°C: Approx. 3V		Engine temperature 80°C: Approx. 1V Engine temperature 20°C: Approx. 3V	
29	Exhaust gas sensor signal		Approx. 0 ~ 1V		Defect between 0 ~ approx. 1V	
32	Monitor & check lamp (red lamp, exhaust temperature warning lamp)		Lamp not lit: Power voltage Lamp lit: 0V		Lamp not lit: Power voltage Lamp lit: 0V	
36	FICD solenoid		A/C ON :0V A/C OFF: Power voltage		A/C ON :0V A/C OFF: Power voltage	
38	Throttle sensor signal		Approx. 0.5V		0.5 ~ 4V (Voltage increase when accelerator pedal is pressed)	
40	Intake air quantity output signal		Approx. 1V		Approx. 1.5V	

RB25DE ENGINE																																																																																																				
<table border="1" style="width:100%; text-align:center; border-collapse: collapse;"> <tr> <td>10</td><td>102</td><td>103</td><td>104</td><td>105</td><td>106</td><td>107</td><td>108</td><td>1</td><td>2</td><td>3</td><td>4</td><td>5</td><td>6</td><td>7</td><td>8</td><td>9</td><td>10</td><td></td><td>21</td><td>22</td><td>23</td><td>24</td><td>25</td><td>26</td><td>27</td><td>28</td><td>29</td><td>30</td><td>41</td><td>42</td><td>43</td><td>44</td><td>45</td><td>46</td><td>47</td><td>48</td><td>49</td><td>50</td> </tr> <tr> <td>109</td><td>110</td><td>111</td><td>112</td><td>113</td><td>114</td><td>115</td><td>116</td><td>11</td><td>12</td><td>13</td><td>14</td><td>15</td><td>16</td><td>17</td><td>18</td><td>19</td><td>20</td><td></td><td>31</td><td>32</td><td>33</td><td>34</td><td>35</td><td>36</td><td>37</td><td>38</td><td>39</td><td>40</td><td>51</td><td>52</td><td>53</td><td>54</td><td>55</td><td>56</td><td>57</td><td>58</td><td>59</td><td>60</td> </tr> </table> <table border="1" style="width:100%; text-align:center; border-collapse: collapse;"> <tr> <td>RX</td><td>TX</td><td></td><td></td><td></td><td></td><td>CHK</td><td>IGN</td> </tr> <tr> <td>-</td><td>CLK</td><td></td><td></td><td></td><td></td><td></td><td></td> </tr> </table>							10	102	103	104	105	106	107	108	1	2	3	4	5	6	7	8	9	10		21	22	23	24	25	26	27	28	29	30	41	42	43	44	45	46	47	48	49	50	109	110	111	112	113	114	115	116	11	12	13	14	15	16	17	18	19	20		31	32	33	34	35	36	37	38	39	40	51	52	53	54	55	56	57	58	59	60	RX	TX					CHK	IGN	-	CLK						
10	102	103	104	105	106	107	108	1	2	3	4	5	6	7	8	9	10		21	22	23	24	25	26	27	28	29	30	41	42	43	44	45	46	47	48	49	50																																																														
109	110	111	112	113	114	115	116	11	12	13	14	15	16	17	18	19	20		31	32	33	34	35	36	37	38	39	40	51	52	53	54	55	56	57	58	59	60																																																														
RX	TX					CHK	IGN																																																																																													
-	CLK																																																																																																			
Terminal No.	Signal name	Circuit	At idle		At Approx. 2,500 rpm																																																																																															
			Standard	Memo	Standard	Memo																																																																																														
41	Crank angle sensor 120° signal		0.3 ~ 0.7V		0.3 ~ 0.7V																																																																																															
42	Crank angle sensor 1° signal		2 ~ 3V		2 ~ 3V																																																																																															
43	Ignition switch (START signal)		0V (Ignition switch START: Power voltage)		0V																																																																																															
44	Neutral switch signal		N or P range: 0V Other than N or P range: 4 ~ 5V		N or P range: 0V Other than N or P range: 4 ~ 5V																																																																																															
46	Air conditioner switch signal		Air conditioner OFF: Power voltage Air conditioner ON: 0V		Air conditioner OFF: Power voltage Air conditioner ON: 0V																																																																																															
48	Intake air quantity output signal		5V		5V																																																																																															

ECCS C/U INPUT/OUTPUT SIGNALS

RB25DE ENGINE

RB25DE ENGINE

101	102	103	104	105	106	107	108	1	2	3	4	5	6	7	8	9	10		21	22	23	24	25	26	27	28	29	30	41	42	43	44	45	46	47	48	49	50
109	110	111	112	113	114	115	116	11	12	13	14	15	16	17	18	19	20		31	32	33	34	35	36	37	38	39	40	51	52	53	54	55	56	57	58	59	60

RX	TX			CHK	IGN
-	CLK				

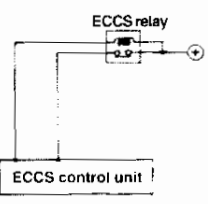
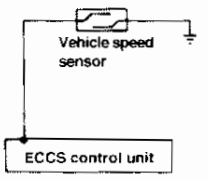
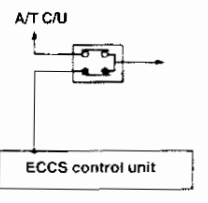
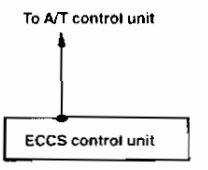
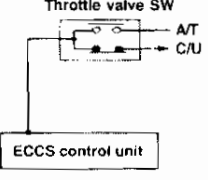
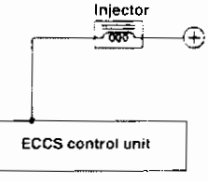
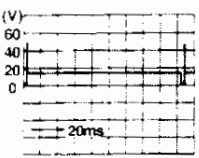
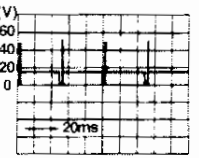
Terminal No.	Signal name	Circuit	At idle		At Approx. 2,500 rpm		
			Standard	Memo	Standard	Memo	
49	ECCS C/U power supply		Power voltage		Power voltage		
53	Vehicle speed sensor signal		D range (or 1st) with rear wheels jacked up: 0.5 ~ 1.5V The value actually deflects between 0V and 5V. However, it appears to deflect around 1V according to vehicle speed.		D range (or 1st) with rear wheels jacked up: 0.5 ~ 1.5V The value actually deflects between 0V and 5V. However, it appears to deflect around 1V according to vehicle speed.		
54	Throttle valve switch (idle contact point)		Approx. 10V		0V when accelerator pedal is pressed		
56	Throttle opening output signal		Approx. 0.5V		Approx. 0.5 ~ 4V (Voltage will increase when accelerator pedal is pressed)		
57	Throttle valve switch (power supply)		Power voltage		Power voltage		
101 103 105 110 112 114	Injector control signal		Almost power voltage			Almost power voltage	



## 10. DECELERATION EXHAUST GAS EMISSION CONTROL EQUIPMENT INSPECTION

### 10-1 THROTTLE VALVE SWITCH SHORT-CIRCUIT (RB26DETT / RB20E / DE / DET ENGINE)

- Remove the throttle valve switch harness connector and use a lead line to connect harness connector terminals (2) and (3).
- The throttle valve sequence power and idle connection points are set ON.

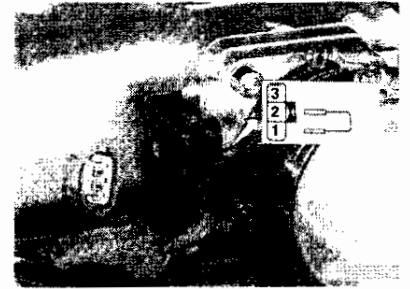

### 10-2 FUEL CUT INSPECTION (RB26DETT / RB20E / DE / DET ENGINE)

- After warming the engine, place the transmission in to neutral and run engine at 2000rpm.
- Lower the speed to approx. 1000 rpm and then raise the speed to 2000rpm again and check for fuel cut.
- If the accelerator opening angle is fixed, the procedures described above will be repeated.

#### (CA18i ENGINE)

- After warming the engine, lift up the rear wheels and remove air cleaner case cover.
- Place wheel stopper, hand brake and apply foot brake.
- Start the engine and place the gear into D range (A/T vehicles) or 4 or 5th gear (M/T vehicles). Run engine at over 2000rpm.
- Check if the injector fuel injection will stop operating when the accelerator pedal is released, and start again when the engine speed decrease to below approx. 1600rpm.

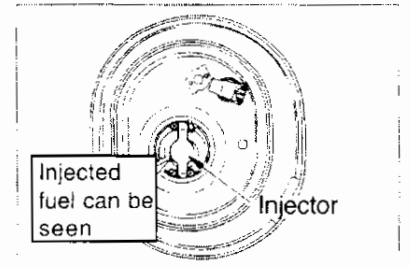

### 10-3 DASH POT INSPECTION AND ADJUSTMENT System inspection (CA18i ENGINE)

- Warm the engine and set the engine rev counter.
- Increase the engine speed to extend dash pot stem.
- Close the throttle valve slowly and check the engine speed when tip of the dash pot stem and the throttle lever contacts.

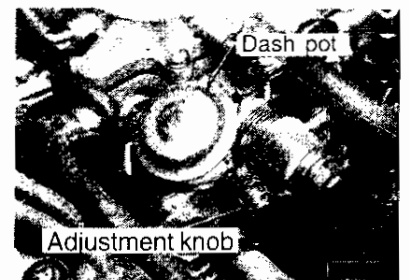

Contact speed (rpm)	M / T	Approx. 3000
	A / T	Approx. 2200

- Check if the dash pot will move and resistance can be felt when the dash pot stem is pushed. Also check if it will return to normal position when hand is removed.

#### Adjustment

- Adjust using adjustment knob on the throttle lever side when contact speed is not at standard value.

## AIR CONDITIONER CUT SYSTEM INSPECTION

RB26DETT / RB20E / DE / DET / CA18i ENGINE

### 10-4 AB VALVE INSPECTION (A / T VEHICLE)

- Remove hose connected to A and place your finger to A.
- Increase engine speed to 3000rpm and close the throttle valve suddenly. At this time check if your finger will feel any suction for 1 to 2 seconds.

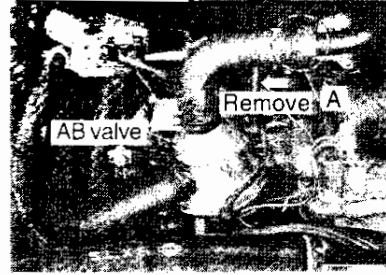

## 11. AIR CONDITIONER CUT SYSTEM INSPECTION

### 11-1 AIR CONDITIONER CUT SYSTEM FUNCTION INSPECTION

- Turn the air conditioner switch to ON position when the engine is idling. Check that the air conditioner compressor will turn ON and then OFF.

## EN4 ENGINE ELECTRICAL EQUIPMENT

### PREPARATION TOOLS

	Name	Application
Measurement equipment	Hydrometer	Battery specific gravity inspection
	Circuit tester	Resistance, voltage inspections

### SPECIFICATION

ITEM		ENGINE	CA18i	RB20E	RB20DE	RB20DET / RB25DE	RB26DETT
BATTERY TYPE (capacity)	Standard	(V-Ah)	34B19R (12-27)	34B19R (12-27)	34B19R (12-27)	34B19R (12-27)	34B19R (12-27)
	Option	(V-Ah)	80D26R (12-55)	80D26R (12-55)	80D26R (12-55)	80D26R (12-55)	80D26R (12-55)
ALTERNATOR TYPE (output)	Standard cold area	Hitachi (V-A)	LR170-717 (12-70)	LR180-705 (12-80)	LR180-705 (12-80)	LR180-705 (12-80)	LR180-705 (12-80)
		Mitsubishi (V-A)	A2T47794 (12-70)	-	-	-	A3T45594 (12-90A)
STARTER MOTOR (output)	Standard	Hitachi (KW)	A/TMS114-320 (0.8)	S114-445 (1.0)	S114-445 (1.0)	S114-445 (1.0)	S114-505 (1.4)
		Mitsubishi (KW)	M/TM3T27686D (0.8) A/TM3T27686H (1.0)	M3T-41185 (1.0)	M3T-41185 (1.0)	M3T-41185 (1.0)	M1T-70685 (1.4)
	Cold area	Hitachi (KW)	-	S114-505 (1.4)	S114-505 (1.4)	S114-505 (1.4)	-
		Mitsubishi (KW)	M1T-71481 (1.4)	M1T-70685 (1.4)	M1T-70685 (1.4)	M1T-70685 (1.4)	-
IGNITION COIL TYPE		Hanshin	IN side: SMC-102 EX side: SMC-152	SMC-200	MPC-302	MPC-302	MPC-302
DISTRIBUTOR TYPE		Hitachi	D4P82-08	-	D6Y88-01 (crank angle sensor)	-	D6Y88-01 (crank angle sensor)
		Mitsubishi	T0T61271A	T0T42071	T2T49171 (crank angle sensor)	T2T49171 (crank angle sensor)	T0T49171 (crank angle sensor)
SPARK PLUG TYPE	Standard	NGK	BCPR5ES-11	BCPR5ES-11	PFR5A-11	PFR5A-11	PFR6A-11
	Option	NGK	BCPR4ES-11 BCPR6ES-11	BCPR4ES-11 BCPR6ES-11	PFR4A-11 PFR6A-11 PFR7A-11	PFR4A-11 PFR6A-11 PFR7A-11	PFR5A-11 PFR7A-11
	Ignition gap (mm)		1.1	1.1	1.1	1.1	1.1

Note: The battery capacity value is the 5-hour rate that conforms to the new JIS standard and the value is 80% of the former 20-hour rate.

[New model name] (example) **34 B 19 R**

|
|
|
|

Terminal polarity position  
 Battery length dimensions (rounded off)  
 Battery width x box height classification  
 Performance rank (starting function added to 5hr capacity)

## 1. BATTERY INSPECTION

### Voltage inspection

Normal	(V)	12.4 ~ 12.8
Limit (charge required)	(V)	12.4 or less
(Start limit)	(V)	12 (20°C)

### Specific gravity inspection (20°C)

Normal		1.29 ~ 1.22
Limit (charge required)	(V)	1.22 or less
Service life		There is a variation width of more than 0.04 between each cell

Additional water does not need to be added to the battery during service life of normal driving. When driving for extended periods of time in high temperatures, the fluid level may decrease according to the vehicle driving conditions. Check the fluid level with the level indicator (upper / lower) and top up to the upper level as necessary.

**Caution:** Distilled water must be used to be added to refill the battery. If ordinary water is used, fluid loss will increase and may cause discharge.

## 2. ALTERNATOR

### (1) Alternator removal and installation

#### CA18i ENGINE

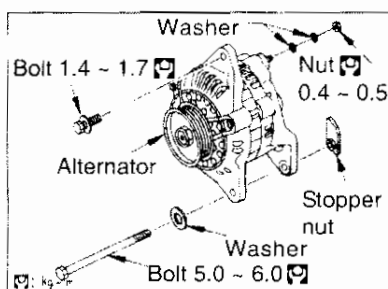

#### RB ENGINE

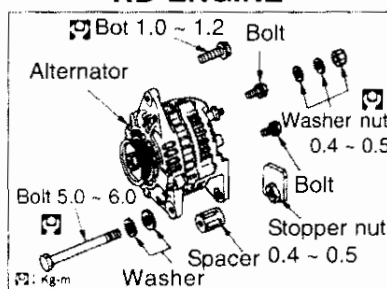

### (2) Alternator inspection

#### Output voltage inspection

- Place ignition switch to ON position and check that charge warning lamp will light.

Standard	(V / rpm)	13.9 ~ 14.9 / 2000 (accessories OFF)
----------	-----------	--------------------------------------

### 3. STARTER MOTOR REMOVAL & INSTALLATION

#### CA18i ENGINE

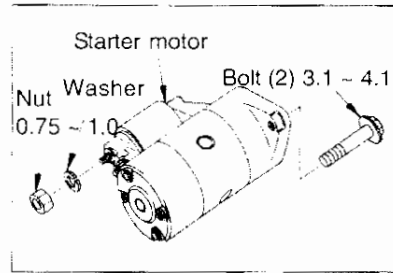

#### RB ENGINE

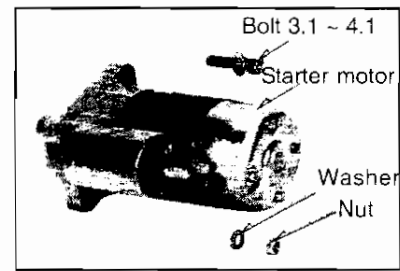

### 4. SPARK PLUG INSPECTION

#### Inspection

- Check for any looseness with terminals.
- Check for any damage or cracks on the insulator.
- Use thickness gauge to check the spark plug gap.

**Spark plug gap (mm): 1.0 ~ 1.1**

### 5. PLATINUM PLUG INSPECTION (RB20DE, RB20DET, RB26DETT)

#### Installation precautions

**Periodic replacement interval: 100,000km**

- Gas inspection and adjustment and plug cleaning using wire brush, should not be performed as this may scrape off the platinum particulate from the platinum tip surface. If plugs are cleaned with an air gun, the cleaning should be performed in less than 20 seconds at an air pressure less than 6.0kg / cm<sup>2</sup>.
- Only use parts specified by Nissan, when replacing the spark plugs.

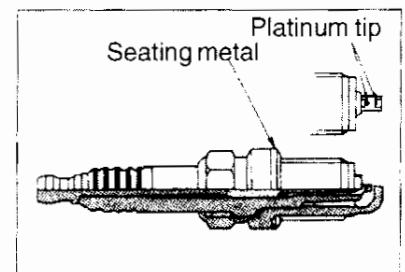

## ENGINE ELECTRICAL EQUIPMENT

RB26DETT / RB20E / DE / DET / CA18i ENGINE

### 6. IGNITION COIL INSPECTION

**CA18i ENGINE (Intake side)**

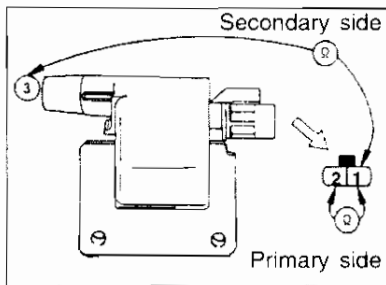

**CA18i (Exhaust side)**

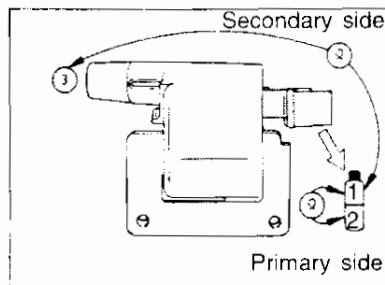

**RB20E ENGINE**

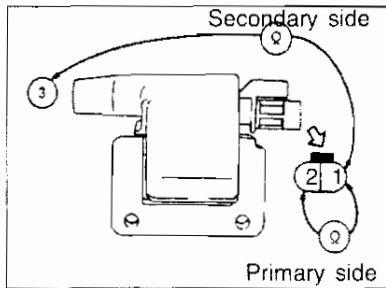

**RB20DE / DET / RB26DETT**

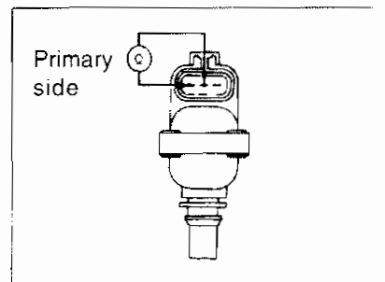

- Check the primary and secondary coil resistance value.

ENGINE	CA18i	RB20E	RB20DE / DET / RB26DETT
Primary resistance	0.7 ~ 1.2	0.8 ~ 1.2	0.6 ~ 0.9
Secondary resistance	7 ~ 12	7 ~ 12	-

## EN5 COOLING SYSTEM

### PREPARATION TOOLS

	Name	Application
Special Tool	Radiator cap tester EG1765 0000	Radiator and cap pressure test
	Radiator cap hose adapter EG1765 0301	Small cap adapter

### SPECIFICATIONS

ENGINE		CA18i	RB20E	RB20DE	RB20DET / RB25DE	RB26DETT
Radiator	Core size (vertical x horizontal x thickness) mm	380 x 646 x 16	380 x 646 x 16	380 x 646 x 16	380 x 646 x 25	380 x 646 x 25
	Fin pitch mm	1.9	1.9	1.5	1.5	1.5
	Cap injection-valve opening pressure (kg / cm <sup>2</sup> )	0.9	0.9	0.9	0.9	0.9
	Radiation performance (Kcal / h°C)	650	650	815	1080	1080
	A/T oil cooler	With (A/T)	With (A/T)	With (A/T)	With (A/T)	-
	Tank material	Plastic	Plastic	Plastic	Plastic	Plastic
	Core material	Alumium	Alumium	Alumium	Alumium	Alumium
Shroud		One piece unit (lower shroud)				
Cooling fan	External diameter mm x No. of layers	410 x 7	420 x 8	420 x 8	420 x 8	420 x 8
	Coupling	2 levels	3 levels	3 levels	3 levels	3 levels
Sub electrical cooling fan	External diameter mm x No. of layers	-	-	-	280 x 5	320 x 4
	Motor output	-	-	-	80	160
	Engine temp switch operation °C	-	-	-	90	90
Thermostat injection-valve opening engine temperature (standard / cold region) (°C)		82 ~ 88	76.5	76.5	76.5	76.5
LLC mixture proportion (standard / cold region) (%)		30 ~ 50	30 ~ 50	30 ~ 50	30 ~ 50	30
Reserve tank capacity (L)		Approx. 0.7	Approx. 0.7	Approx. 0.7	Approx. 0.7	Approx. 0.7
Cooling water total capacity (L)		Approx. 7	Approx. 8	Approx. 9	Approx. 9	Approx. 8.7

## 1. RADIATOR INSPECTION

### Cooling water leak inspection

- Use radiator cap tester and apply pressure (limit 1.0kg / cm<sup>2</sup>) and check for leakage.

#### Caution:

When using the radiator cap tester, always make sure to connect the hose adapter and filler cap is not deformed.

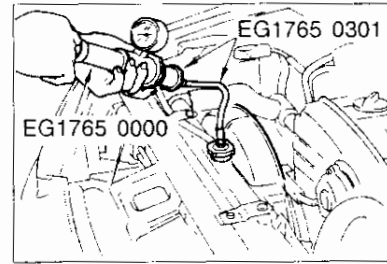

## 2. RADIATOR CAP INSPECTION

### Inspection

- Clean cap rubber packing seal surface and vacuum with dry brush.
- Attach radiator cap tester to cap. Apply pressure and check that valve operates correctly.

Radiator cap relief pressure (kg/cm <sup>2</sup> )	0.6 ~ 1.0
--	-----------

- Pull vacuum valve with finger and check operation.

## 3. COOLING WATER FILLING PROCEDURES

- 1 Make sure the radiator hose and heater hose clamps are tightened securely.
- 2 Set the heater control lever to HOT position. (For vehicles equipped with automatic air conditioners, first place ignition switch to ON position and remove the external sensor connector).
- 3 Release the radiator cap and air drain plug. (RB20E: Intake manifold collector area. RB20DE / DET: Intake manifold collector area and in front of glove box).
- 4 Fill the radiator gradually (filling speed: slower than 2L / min) to the top of the spout with coolant. Fill the radiator until the water in the reserve tank reaches the MAX level line indicated.
- 5 After closing the radiator cap and air drain plug (RB system), start the engine and allow it to idle.
- 6 The engine will continue to idle until the thermostat opens. (Touch the radiator flow hose and make sure hot water is flowing). If a large volume of air remains, the water temperature gauge needle will move past the middle as the engine temperature rises abnormally. If this occurs, stop the engine wait until it cools and add water to the radiator repeatedly as described above.

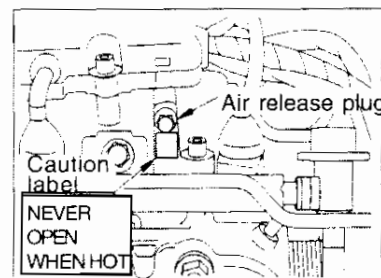

After the thermostat opens, race the engine for 10 seconds at 2500rpm two or three times. Check that

the water temperature does not rise excessively.



- 7 Stop the engine and allow it to cool. Release the radiator cap and check the fluid level. If the fluid level lowers, return to step 4 and repeat the process.  
OR vehicle equipped with automatic air conditioning, connect the fresh air sensor connector.

#### 4. RADIATOR REMOVAL AND INSTALLATION

##### CA18i ENGINE

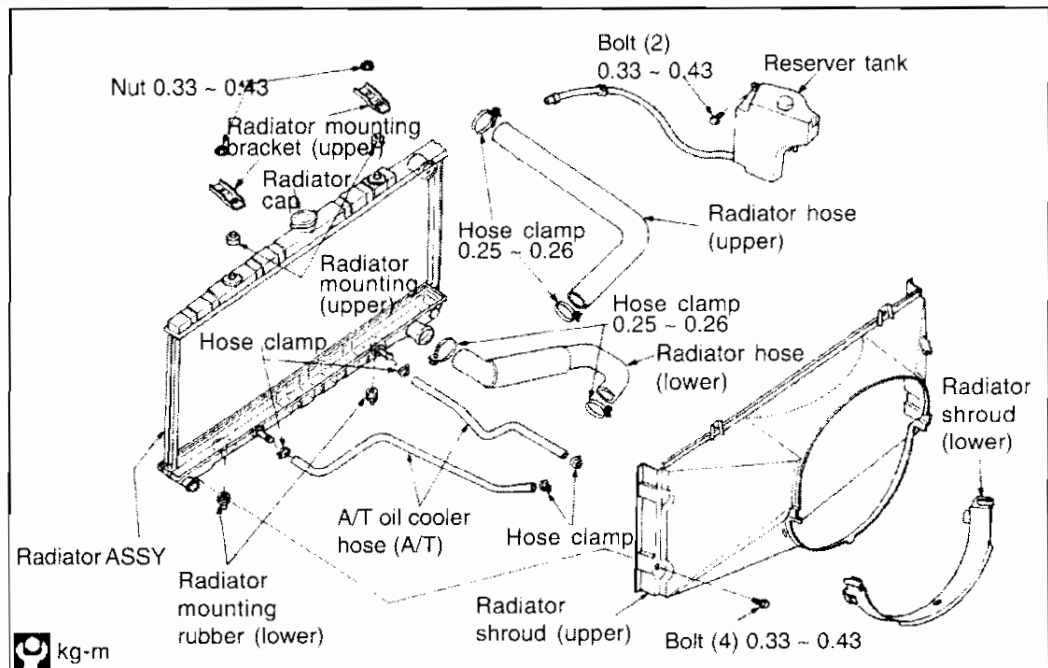

##### RB ENGINES (RB20E / DE / DET / RB25DE / RB26DETT)

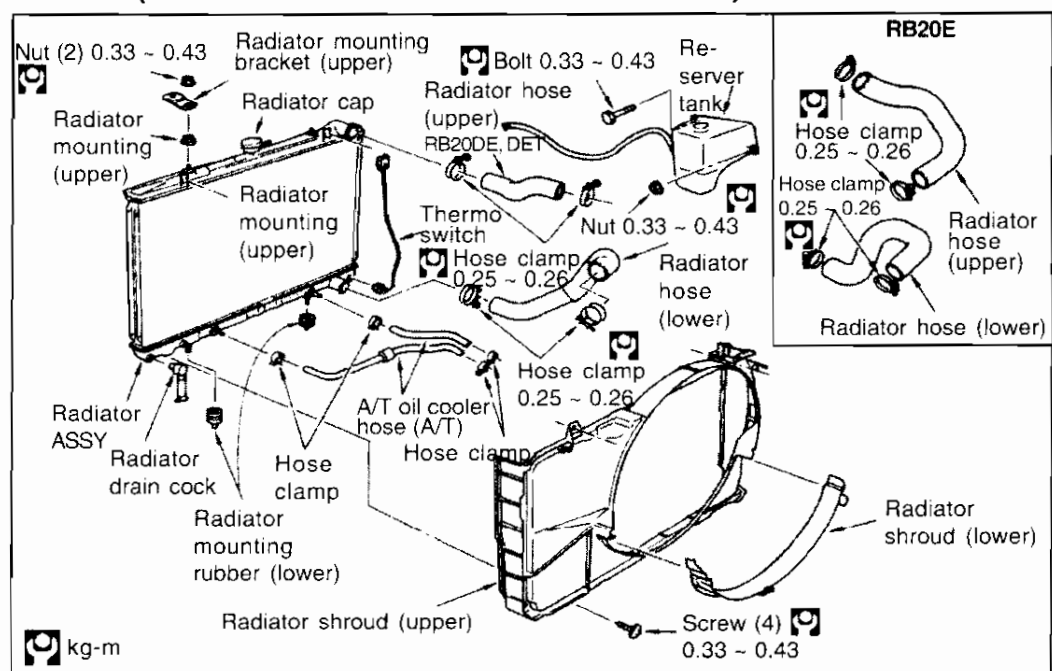

**Additional work required:**

- Drain and fill cooling water
- Remove A/T oil cooler hose (A/T vehicle)
- Remove supplementary electrical fan connector

**[Point 1] Radiator shroud (lower) removal**

- While pushing hooks (left and right 2 locations) to release, remove pawls and detach shroud.

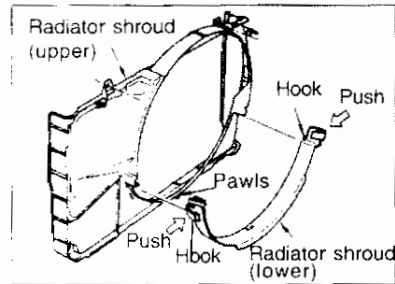

**5. SUB ELECTRICAL FAN INSPECTION (RB20DET / RB26DETT / RB25DE)**

**Operation**

Radiator fan ON condition	Thermoswitch ON (engine temperature over 90°C)
---------------------------	---

**Function inspection**

- Place ignition switch to OFF position and remove switch harness connectors and short-circuit harness connector.
- Check that fan motor operates correctly when ignition switch is placed to ON position.

**Thermoswitch inspection**

- Heat thermoswitch with high-temperature water or oil (heat with heat gun, for example) and check if it conforms to values in chart below:

<b>Temperature (°C)</b>	Valve rised: 90 +/- 3 max. Valve lowered: 83 +/- 3 max.	Valve rised: 90 +/- 3 min. Valve lowered: 83 +/- 3 min.
<b>Thermoswitch connection condition</b>	Non-continuity	Continuity
<b>Thermoswitch tightening torque (kg/m)</b>	0.3 ~ 0.5	

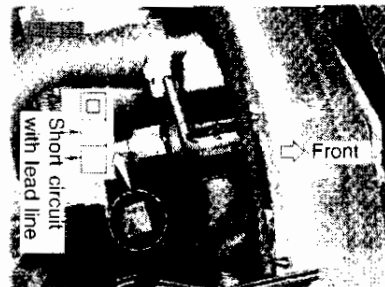
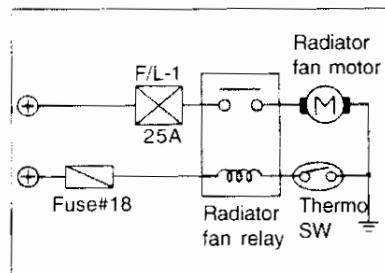

**6. THERMOSTAT INSPECTION**

**Inspection**

- Check that valve opening temperature and maximum valve lift conform to specified value.
- Place a string in thermostat valve and inset it in container of water. While holding thermostat heat the water.
- The valve opening temperature is the temperature when the thermostat falls off the string.

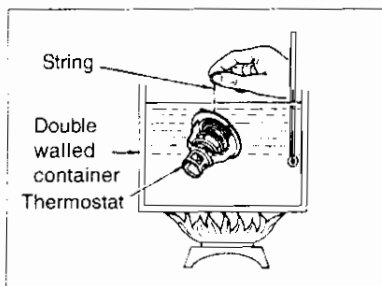

ENGINE	CA18i (standard)	CA18i (cold climate)	RB ENGINES
Valve opening temperature (°C)	82	88	76.5
Maximum valve lift (mm/°C)	8 min / 95	7 min / 100	10 min / 90

## EN6 FUEL SYSTEM

### PREPARATION TOOLS

	Name	Appliation
Measurement tool	Circuit tester	Fuel gauge inspection

### SPECIFICATIONS

ENGINE		CA18i	RB20E / DE / DET / RB25DE	RB26DETT
<b>ITEM</b>				
<b>Fuel tank main body</b>	<b>Nominal capacity (L)</b>	60	60	72
	<b>Intake air capacity (L)</b>	8.4	8.4	5.5
	<b>Remaining volume capacity for warning lamp activation (L)</b>	Approx. 9.9	Approx. 9.9	Approx. 13
	<b>Warning lamp effective remaining volume (L)</b>	Approx. 7.5	Approx. 7.5	Approx. 12.8
	<b>Fuel gauge E indication effective volume (L)</b>	Approx. 4.8	Approx. 4.8	Approx. 8
	<b>Drain plug</b>	Starndard: None Cold: Installed	Starndard: None Cold: Installed	None
<b>Fuel pump</b>		Tank intake electrical system		
<b>Filler cap</b>	<b>Type</b>	Screw in (vacuum relief valve installed)		
	<b>Relief valve opening valve pressure (mm/Hg)</b>	-45 to -25		
<b>Fuel overflow prevention system</b>		Internal air chamber system (check valve attached)		
<b>Fuel gauge unit</b>	<b>Gauge system</b>		Float arm system	
	<b>Resistance</b>	<b>F</b>	Approx. 6	
		<b>E</b>	Approx. 80	
<b>Remaining volume warning system</b>		Thermistor system		
<b>Evaporation system</b>		Canister system		
<b>Fuel tube diameter</b>	<b>Outlet (mm)</b>	8		
	<b>Return (mm)</b>	8		

1. FUEL TANK REMOVAL & INSTALLATION

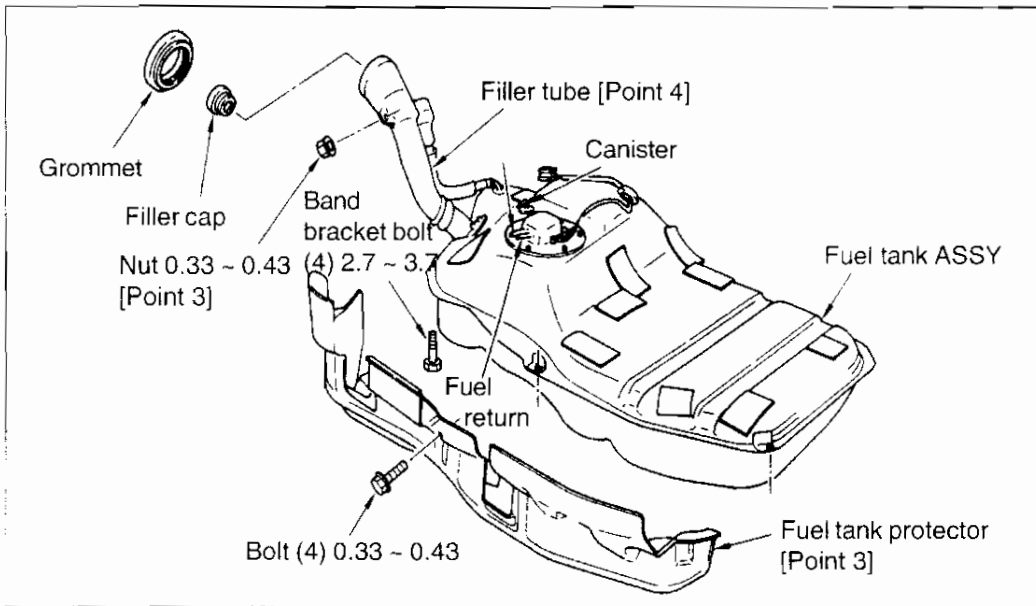

**Additional work required:**

Drain fuel

Remove the following:

- Fuel pressure relief valve [Point 1]
- Fuel tank internal pressure relief
- Filler tube protector
- Inspection hole cover [Point 2]
- Fuel gauge unit, fuel pump harness connector [Point3]
- Fuel tank protector
- Hoses

**[Point 1] Fuel pressure relief**

- After starting the engine, remove fuel pump fuse and wait until engine stops. Crank engine 4 to 5 times to consume fuel in lines.
- For vehicle which can not be started, remove fuel pump fuse, crank engine 4 to 5 times to consume fuel in lines.

**Caution:**

The battery may become weak easily, use booster cables to connect it to another vehicle or battery if necessary.

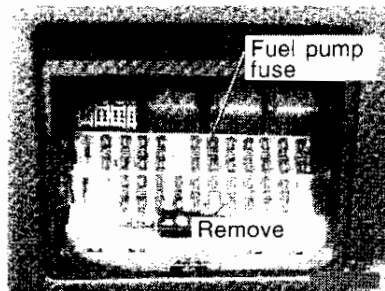

**[Point 2] Inspection hole cover, harness cover, fuel gauge unit harness connector removal & installation**

**Removal**

- Remove rear finisher and detach the fuel gauge unit harness connector.

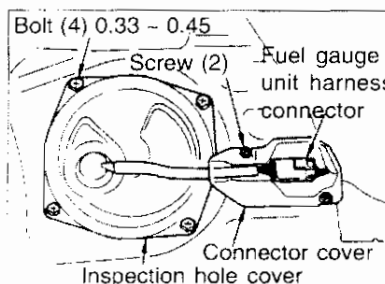

**Installation**

- Check that fuel gauge unit and fuel pump harness connectors are connected securely.
- Check that fuel hose connections are secure.

Bolt tightening torque	0.33 ~ 0.45
------------------------	-------------

**[Point 3] Fuel tank removal & installation**

**Removal**

- Remove feeler tube protector and detach bolt shown in the figure on right.
- Remove feeler tube grommet from the body.
- Remove fuel tank protector, fuel tank band mount bolts and detach fuel tank.

**Installation**

- Attach tank and secure by tightening mount bolt on front side of right member to specified torque.

Band mount bolt tightening torque	2.8 ~ 3.6 kg-m
Protector nut tightening torque	0.33 ~ 0.43 kg-m

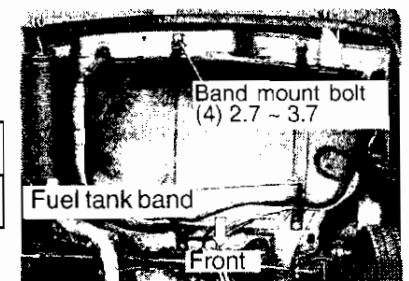

**[POINT 4] Feeler tube installation**

- Use specified feeler tube bolt to install feeler tube.

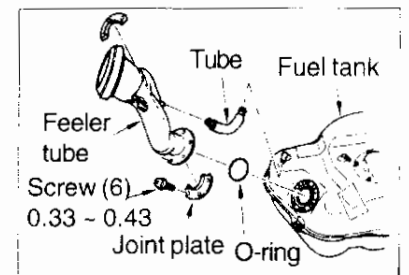

**2. FUEL GAUGE**

**(1) Fuel gauge ASSY removal & installation**

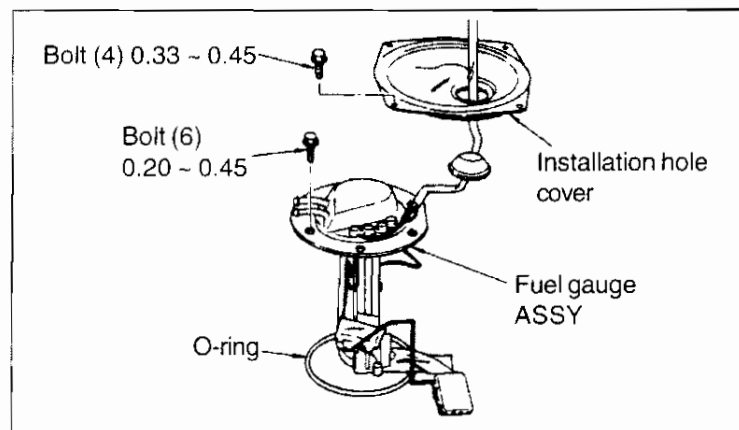

**Additional work required:**

Remove the following:

- Fuel pressure relief
- Internal pressure relief
- Inspection hole cover
- Fuel gauge limit
- Fuel pump harness connector
- Fuel hose (return, feed)

**[Point 1]**

**Fuel gauge ASSY bolts installation**

- Set O-ring to fuel tank side and insert gauge ASSY inside the tank. Tighten the bolts shown in the figure on the right.

Caution:

Extra caution must be taken not to damage float and the arm when installing gauge ASSY.

Only use specified bolts when installing fuel gauge ASSY.

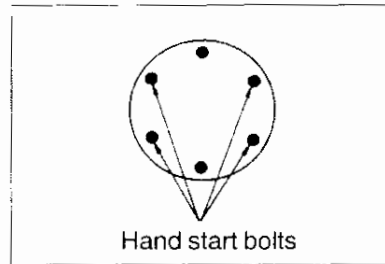

**(2) Fuel pump removal & installation**

**Removal**

- Loosen hose clamp on unit side on the pump side.
- Lift up the pump slightly. Remove pump with the insulator from gauge unit side bracket (PIC A).
- Remove pump side harness.
- Detach hose.

**Installation**

- Carry out installation operation in reverse order.

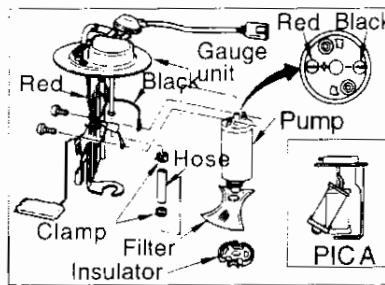

**(3) Inspection**

**1. Float inspection**

- Place the float at the F (lever upper side) and E (lever down side) positions and check the resistance.

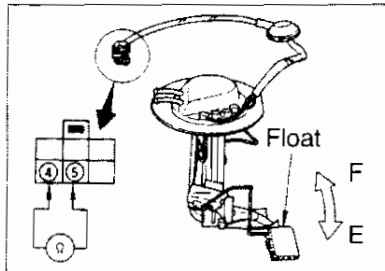

Inspection terminal	F position	E position
4 ~ 5	Approx. 6	Approx. 80

**2. Pump inspection**

- Apply battery voltage to harness connector terminal 1 and 3 and check its operation.

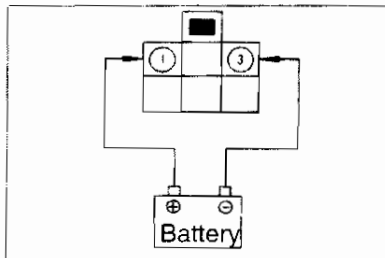

**3. Low fuel warning lamp sensor inspection**

- Connect 12V to 3.4W test lamp or equivalent.

- Wash sensor with gasoline or white gasoline and check that lamp does not light after approx. 3 minutes have elapsed.
- Remove sensor from gasoline or white gasoline and check that lamp lights within 3 minutes.

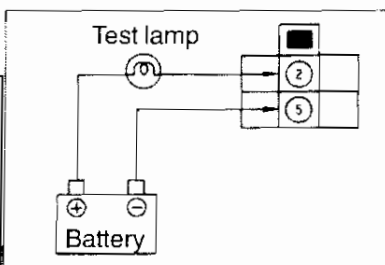

### 3. FUEL PUMP REMOVAL & INSTALLATION

#### (1) Fuel pump disassembly

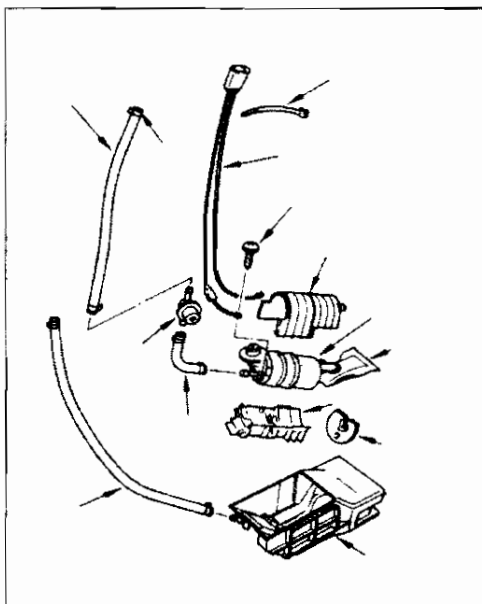

**Additional work required:**

- Remove the following:
- fuel pressure relief
  - Internal pressure relief
  - Fuel gauge

Caution:

- Care must be taken when handling fuel pump.
- Do not reuse pump if it is dropped.
- Do not allow dirt or debris to adhere to the filter.
- Do not twist or turn harness.

#### [Point 1] Fuel hose removal & installation

**Removal**

- Raise fuel gauge ASSY, remove 2 hoses in tank (marked section is outlet side), fuel pump harness connector and detach fuel gauge ASSY.

**Installation**

- Check fuel hose marking, connect fuel gauge ASSY. Position pump harness and clamp band 160mm in from gauge ASSY connecting part and tighten securely.
- Care must be taken that fuel hose and fuel harness turn inside tank from the right to front side of vehicle and do not cause any interference with float arm.

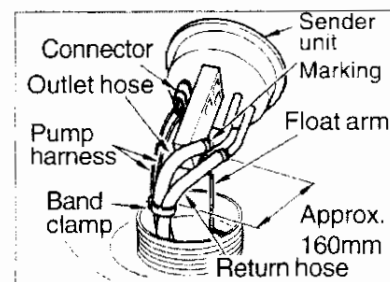

## EN7 EXHAUST SYSTEM

## SPECIFICATIONS

ENGINE		CA18i	RB20E	RB20DE	RB20DET / RB25DE	RB26DETT	
ITEM							
Front tube	Tube outer diameter mm	Dual portion	-	42.7	45	-	54
		Single portion	45	50.8	60.5	63.5	70
	Long dual tube		-	Installed	Installed	-	-
	Flexible tube		-	-	-	-	Installed
	Pre-muffler (L)		-	-	-	-	-
Muffler ASSY	Center tube outer diameter mm		45	50.8	50.8	63.5	70
	Pre-muffler mm						
	Flexible tube		-	-	-	-	-
	Dynamic damper		Installed	Installed	A/T only	A/T only	Installed
	Main muffler capacity (L)		13	13	13	13	16
Tail pipe external diameter mm		45 x 1	45 x 1	59 x 83 (ellipse)	59 x 83 (ellipse)	59 x 83 (ellipse)	
Catalytic converter	Types		Manifold three way, single unit	Under body floor, three way, single-unit	Under body floor, three way, single-unit	Under body floor, three way, single-unit	Under body floor, three way, single-unit
	Capacity (L)		0.9	1.7	1.7	1.3	1.7
	Catalytic metal		Platinum rhodium	Platinum rhodium	Platinum rhodium	Platinum rhodium	Platinum rhodium
Exhaust gas temperature warning equipment operation temperature °C		Approx. 940	Approx. 850	Approx. 850	Approx. 850	Approx. 850	

## Exhaust system part inspection, warning precautions

- The heat resistance and corrosion resistance in exhaust system parts and component shape have been carefully considered in the design process, so only use genuine Nissan parts for replacement.
- Clean each connection part and connect securely, making sure there are no gas leaks.
- Always use new gaskets in the front and rear of catalytic converter.
- Always use new parts for exhaust manifold connection gasket and nuts.
- After assembling each part, when warm engine, raise speed to 2,000 to 3,000 rpm and make sure there are no gas leaks, sealing compound leaks or sealing gaps.
- Replace parts rather than repairing extreme deformation in heat insulation panels. If extreme amount of dirt have accumulated, clean these areas.
- When attaching heat insulation panels, make sure there is adequate clearance and no interference between exhaust pipes.



**1 EXHAUST PIPE, CATALYTIC CONVERTER & HEAT PANEL TIGHTENING TORQUES**

**(1) CA18i ENGINE**

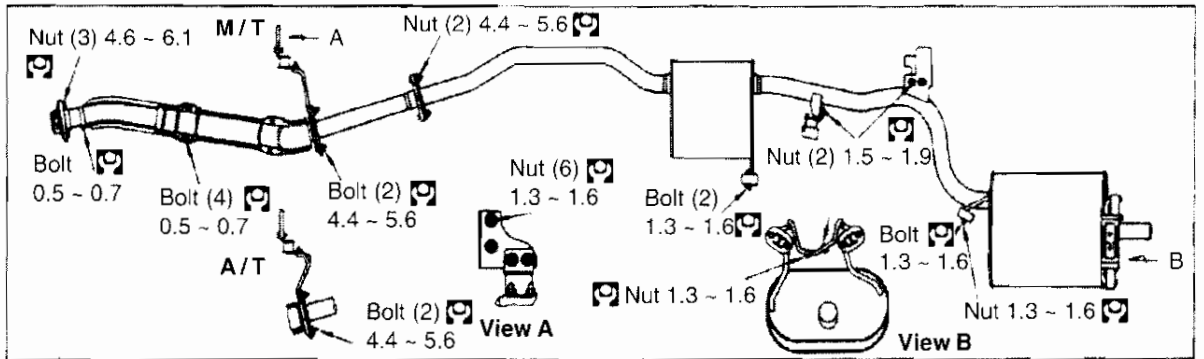

**(2) RB20E ENGINE**

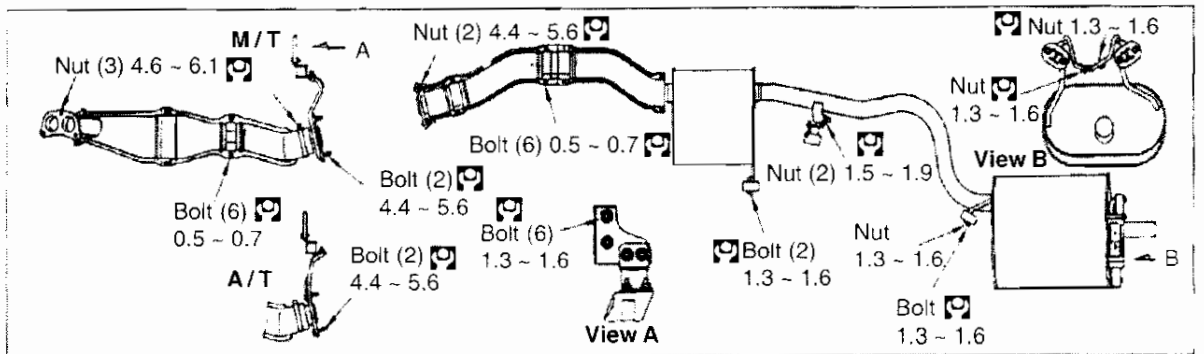

**(3) RB20DE**

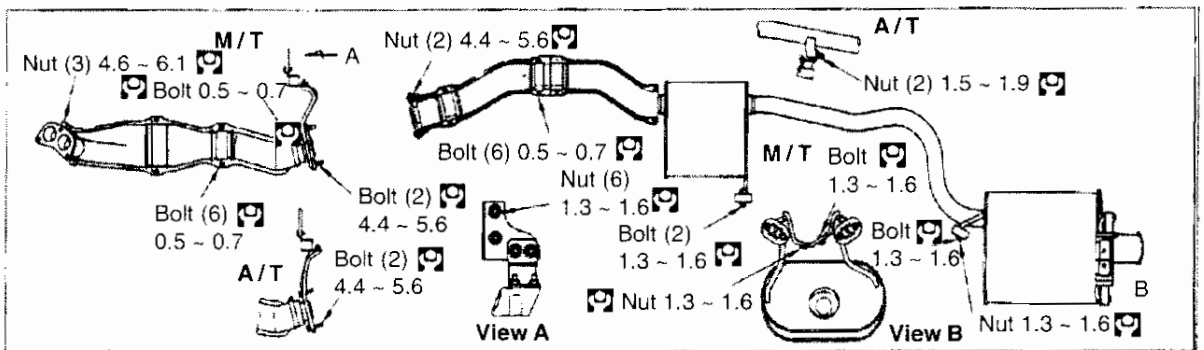

**(4) RB20DET**

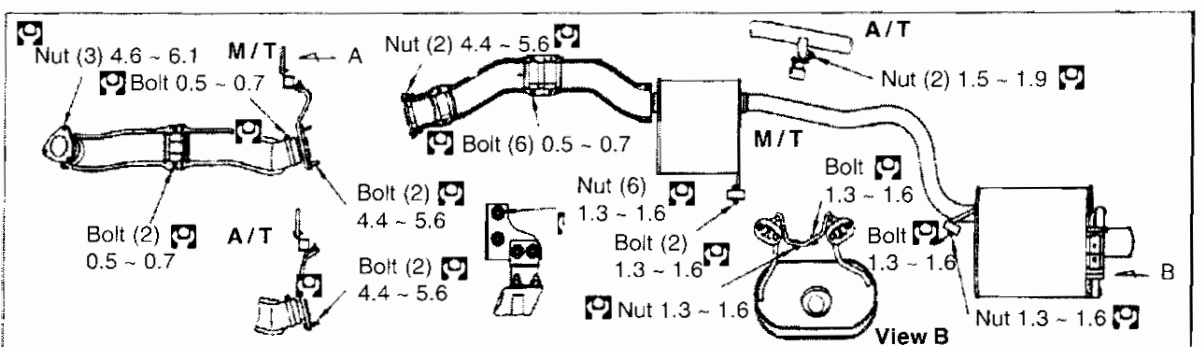



**2. EXHAUST GAS TEMPERATURE WARNING EQUIPMENT INSPECTION**

**Basic inspection**

- Place ignition switch to ON position and check that exhaust gas temperature warning lamp does not turn on.
- Exhaust gas temperature warning lamp must light when ignition switch is placed at START position and must go off when engine is started.

**Exhaust gas temperature warning lamp replacement and inspection**

- Remove vehicle harness from switching module.
- Use lead line to ground vehicle side harness connect exhaust gas temperature warning lamp terminal.
- Inspect condition of exhaust gas temperature warning lamp with ignition switch turned ON.

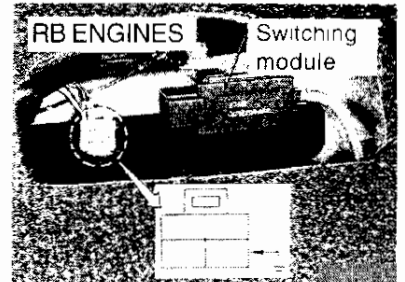
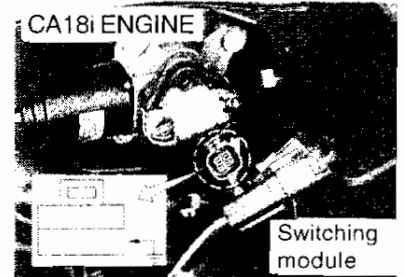

<b>Lamp lights</b>	Faulty circuit between ignition switching module. Faulty key sensing module or sensor.
<b>Lamp does not light</b>	Exhaust gas temperature warning lamp is burned out. Exhaust gas temperature warning lamp power circuit is faulty.

**EN8 ENGINE CONTROL (INCLUDE ASCD DEVICE)**

**1. ACCELERATOR PEDAL INSPECTION AND ADJUSTMENT**

**Accelerator pedal inspection**

- The engine must be full throttle when accelerator pedal is pressed fully (pedal lever contacts the stopper completely).

**Accelerator pedal adjustment**

- Loosen lock nuts so accelerator cable has adequate slack. Pull outer case in direction of accelerator pedal from position where throttle drum starts operating (there must be no play at this point), return lock nuts 1.0 to 1.5 turns and tighten securely.

**CA18i**

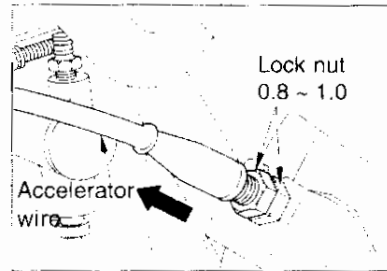

**RB20E**

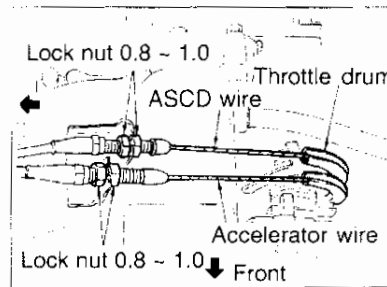

<b>Tightening torque (kg-m)</b>	0.8 ~ 1.0
---------------------------------	-----------

**RB20DE / DET / RB25DE**

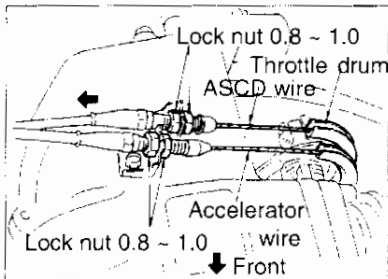

**RB26DETT**

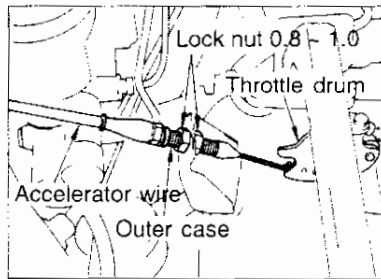

**Kickdown switch adjustment (RB engine A / T vehicles)**

- Press accelerator pedal to fully open throttle drum. Adjust lock nut so the gap is between 0.3 to 1.0mm.

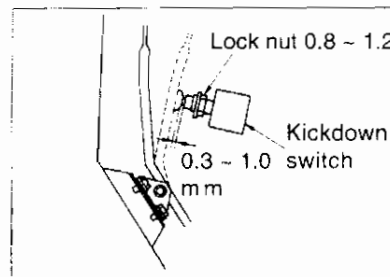

2. ASCD

Specification

Speed setting range	Approx. 50 ~ 100km / h
Constant speed control range	Level road +0 / -2 km / h
Memory type	Digital memory
Control type, actuator driver source	Negative pressure control, negative pressure pump
Actuator stroke	Approx. 33mm
Set system	One-touch system (with tap down system)
Resume system	Installed
Acceleration system	Installed (with tap up system)
Over drive cancel system	Installed

System

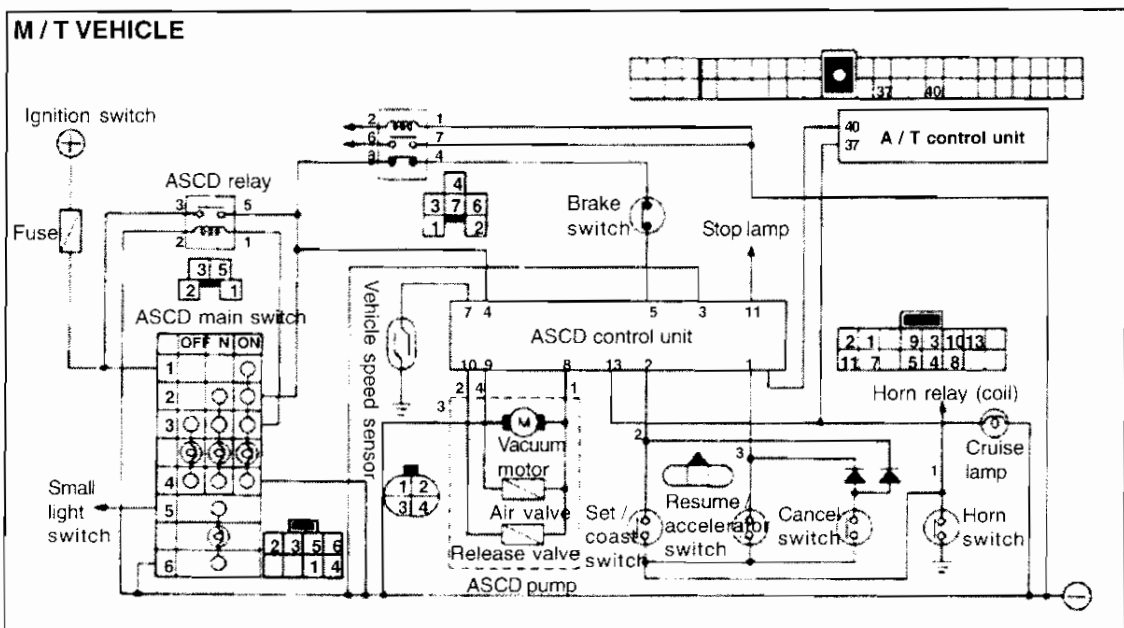
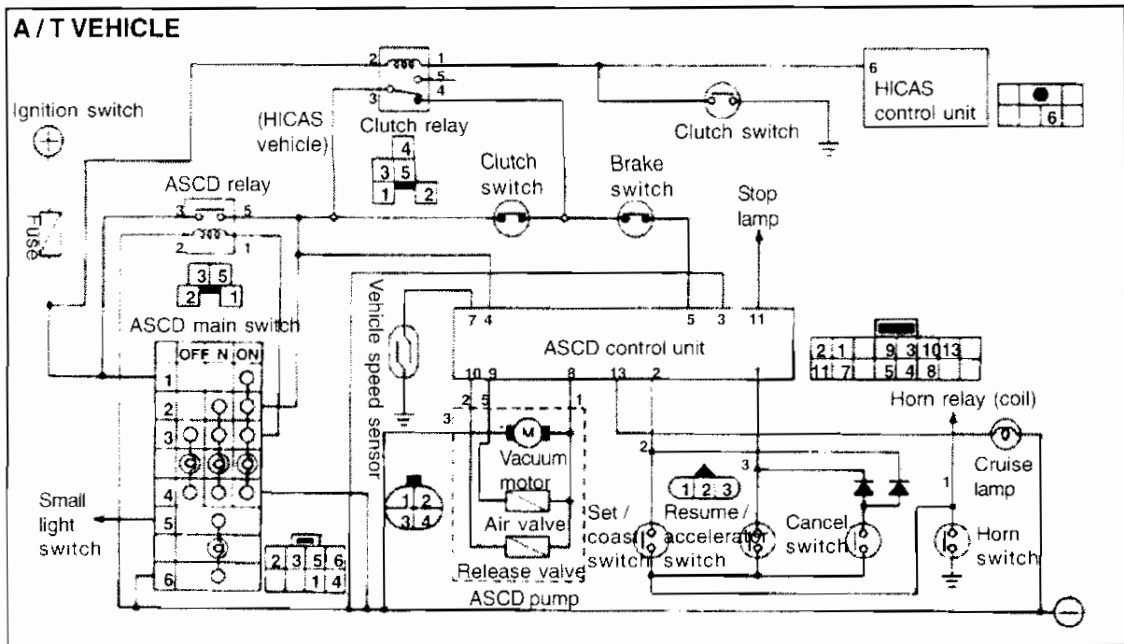

2-1 ASCD INSPECTION AND ADJUSTMENT  
(1) FAULT DIAGNOSIS

Problem	Parts	Main SW	Set / Coast SW	Resume / accelerator SW	Stop lamp SW, clutch SW (M/T), inhibitor SW (AT)	Vehicle speed sensor	Controller	Pump	Actuator	Other
Does not operate		Faulty	set / coast SW faulty	Resume / accelerator SW faulty	Faulty adjustment or faulty parts	Main unit faulty	Inside circuit faulty	Main unit faulty	Faulty valve, faulty diaphragm	ASCD system wiring, harness disconnection, piping disconnection
	Hunting	-	-	-	-	-	Inside circuit faulty	Main unit faulty	Faulty response	Piping breakage, actuator meter resistance, faulty speed meter cable
Setting unstable	Cancel	-	-	-	-	-	Inside circuit faulty	Main unit faulty	Diaphragm leak	Faulty speed meter cable
	Large gap between set vehicle speed	-	-	-	-	-	Inside circuit faulty	Main unit faulty	Catch or leaking diaphragm	Actuator wire catch
	Vehicle speed decrease when setting	-	-	-	-	-	Inside circuit faulty	Main unit faulty	-	Faulty actuator wire adjustment, faulty pipings, clogging
Does not cancel		-	-	-	-	-	Inside circuit faulty	Main unit faulty	-	Actuator wire locking

**INSPECTION & MAINTENANCE PROCEDURE WHEN IT CAN NOT BE SET**

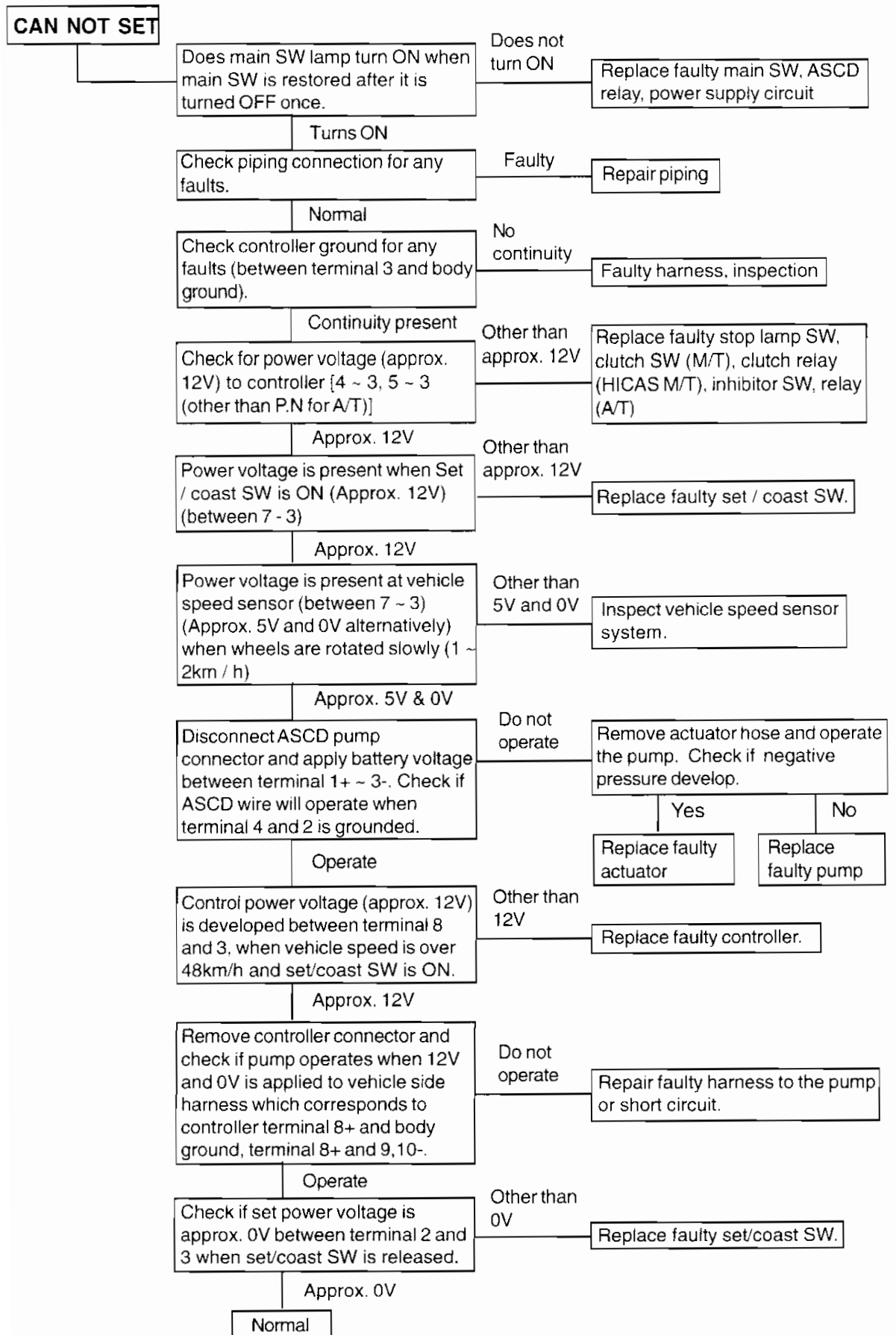

**INSPECTION & MAINTENANCE PROCEDURE WHEN SETTING IS UNSTABLE (HUNTING)**

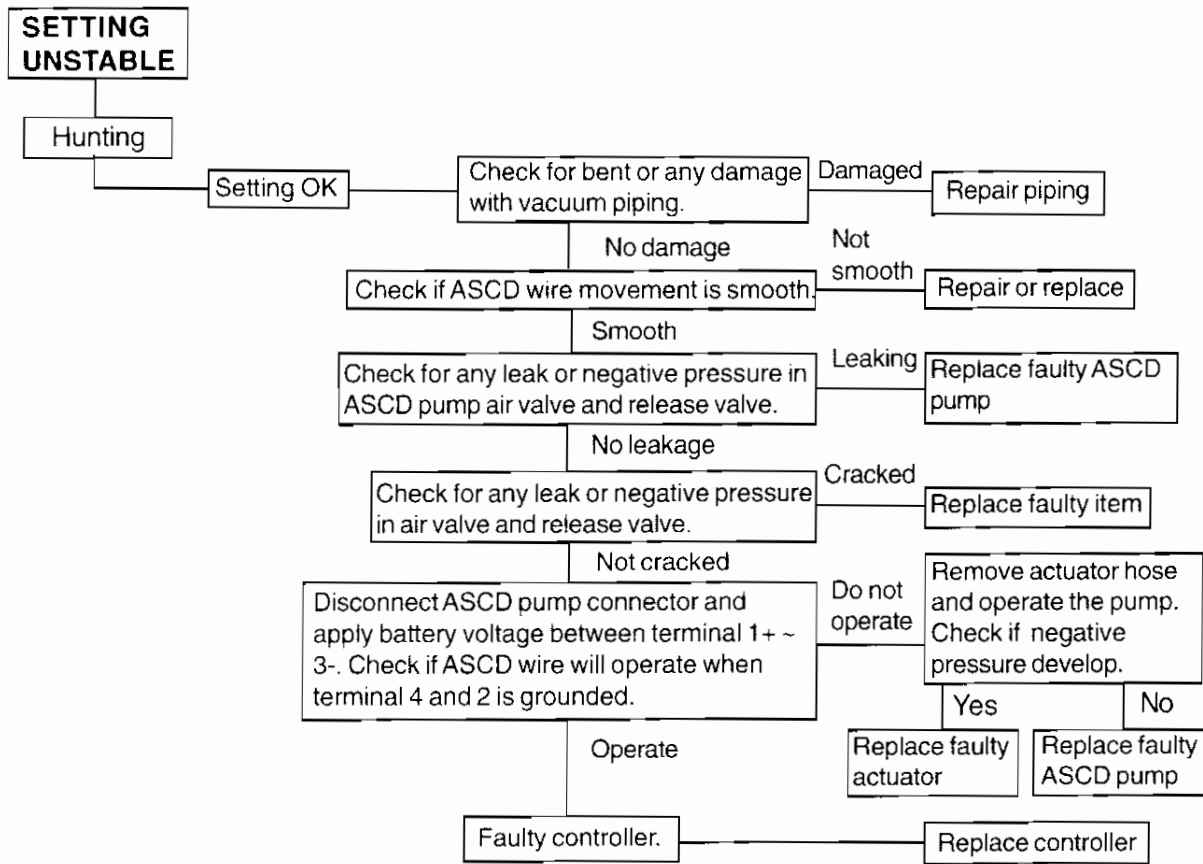

**INSPECTION & MAINTENANCE PROCEDURE WHEN SETTING IS UNSTABLE (CANCEL)**

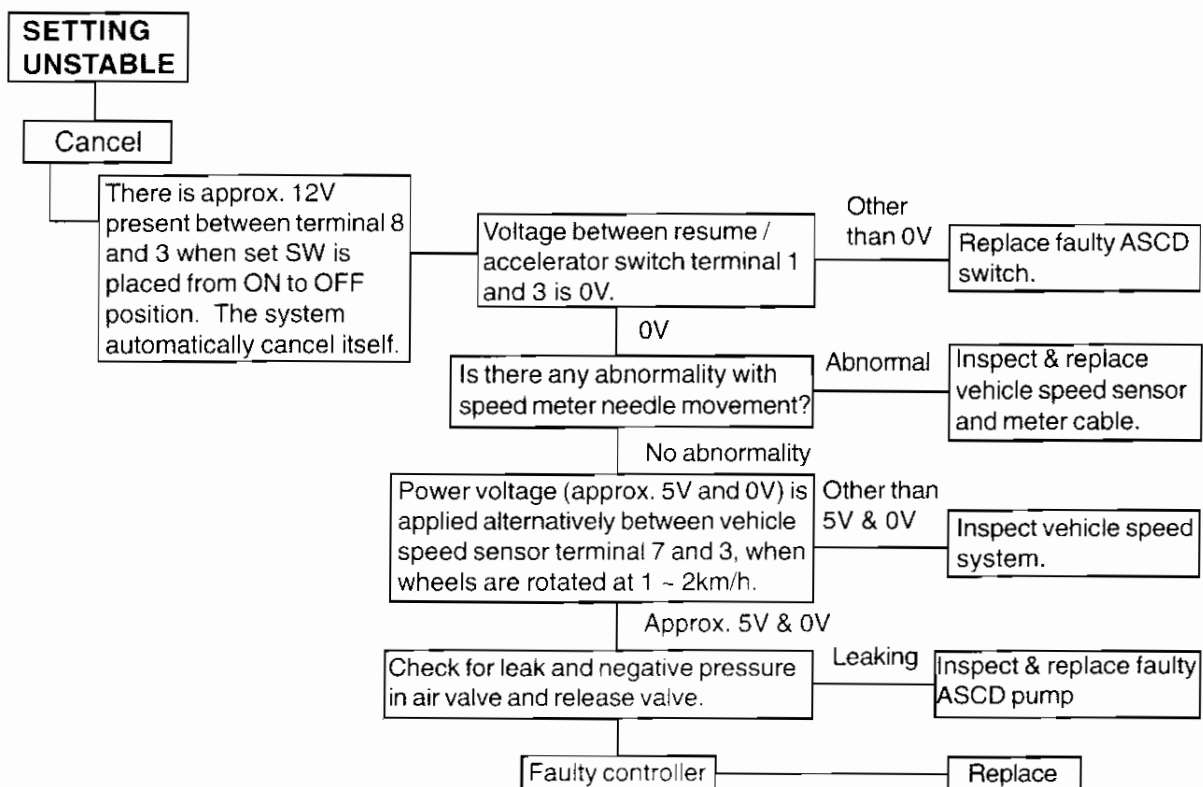



**INSPECTION & MAINTENANCE PROCEDURE WHEN SETTING IS UNSTABLE (DIFFERENT TO SET VALUE)**

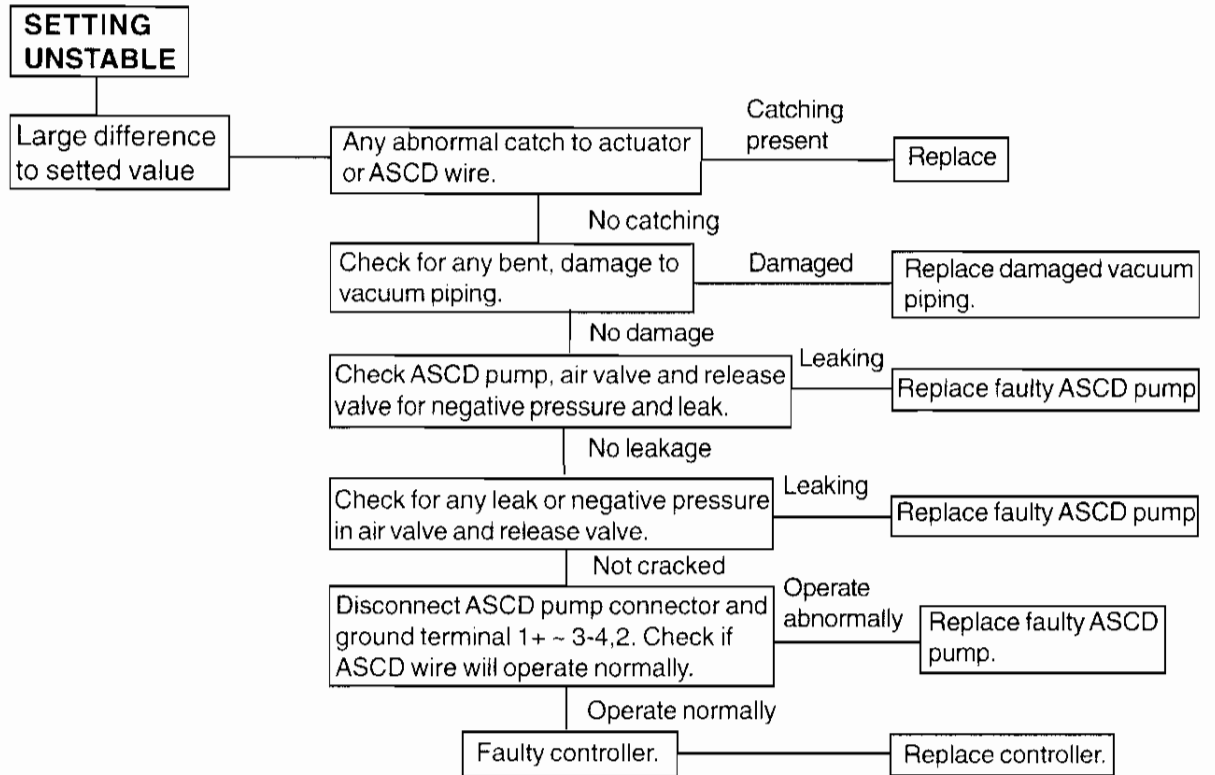

**INSPECTION & MAINTENANCE PROCEDURE WHEN SETTING IS UNSTABLE (Plunge in vehicle speed)**

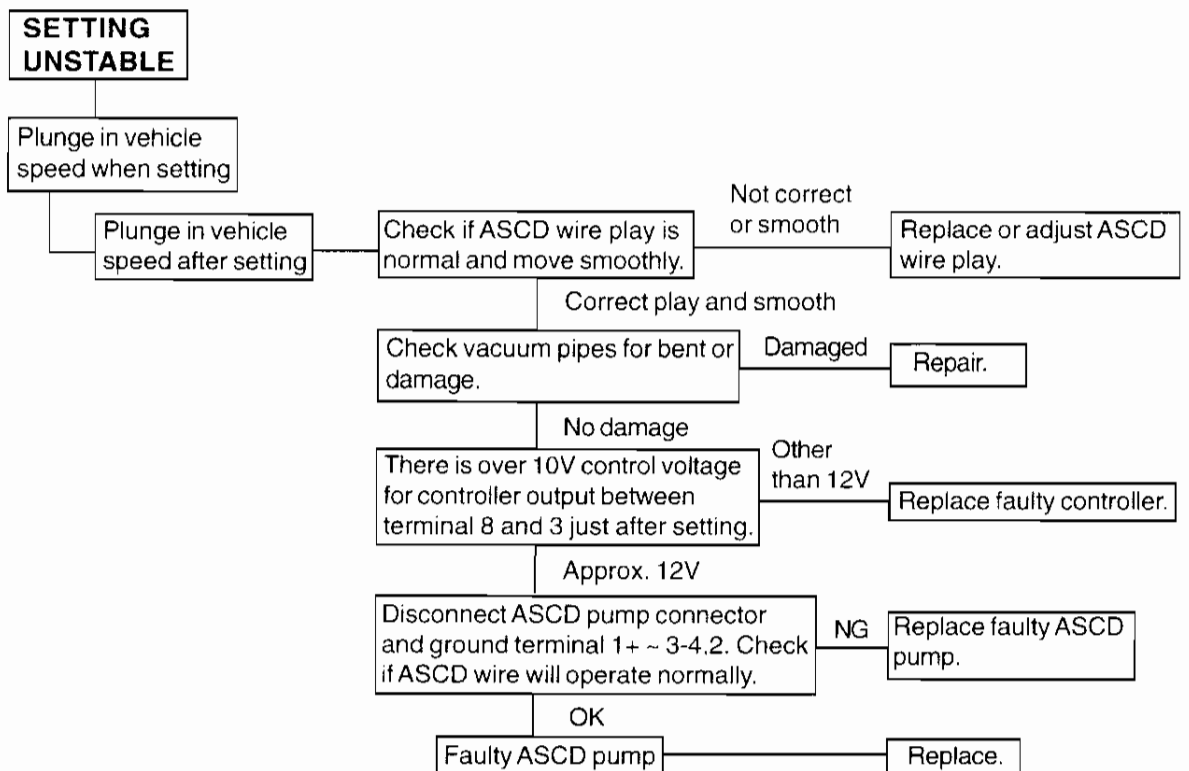

**INSPECTION & MAINTENANCE PROCEDURE WHEN ACCELERATOR DEVICE DOES NOT OPERATE**

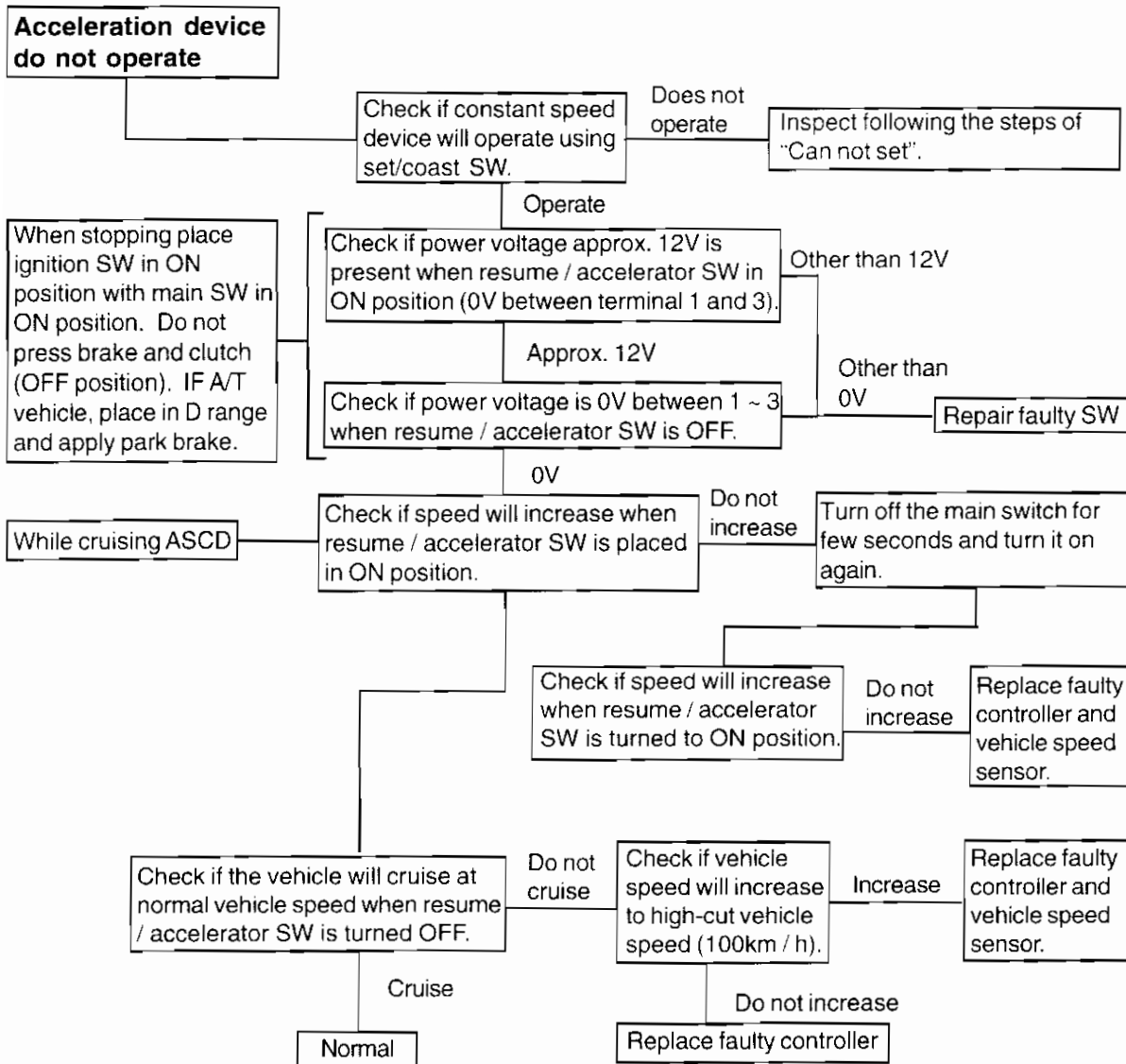

**INSPECTION & MAINTENANCE PROCEDURE WHEN RESUME DEVICE DO NOT OPERATE**

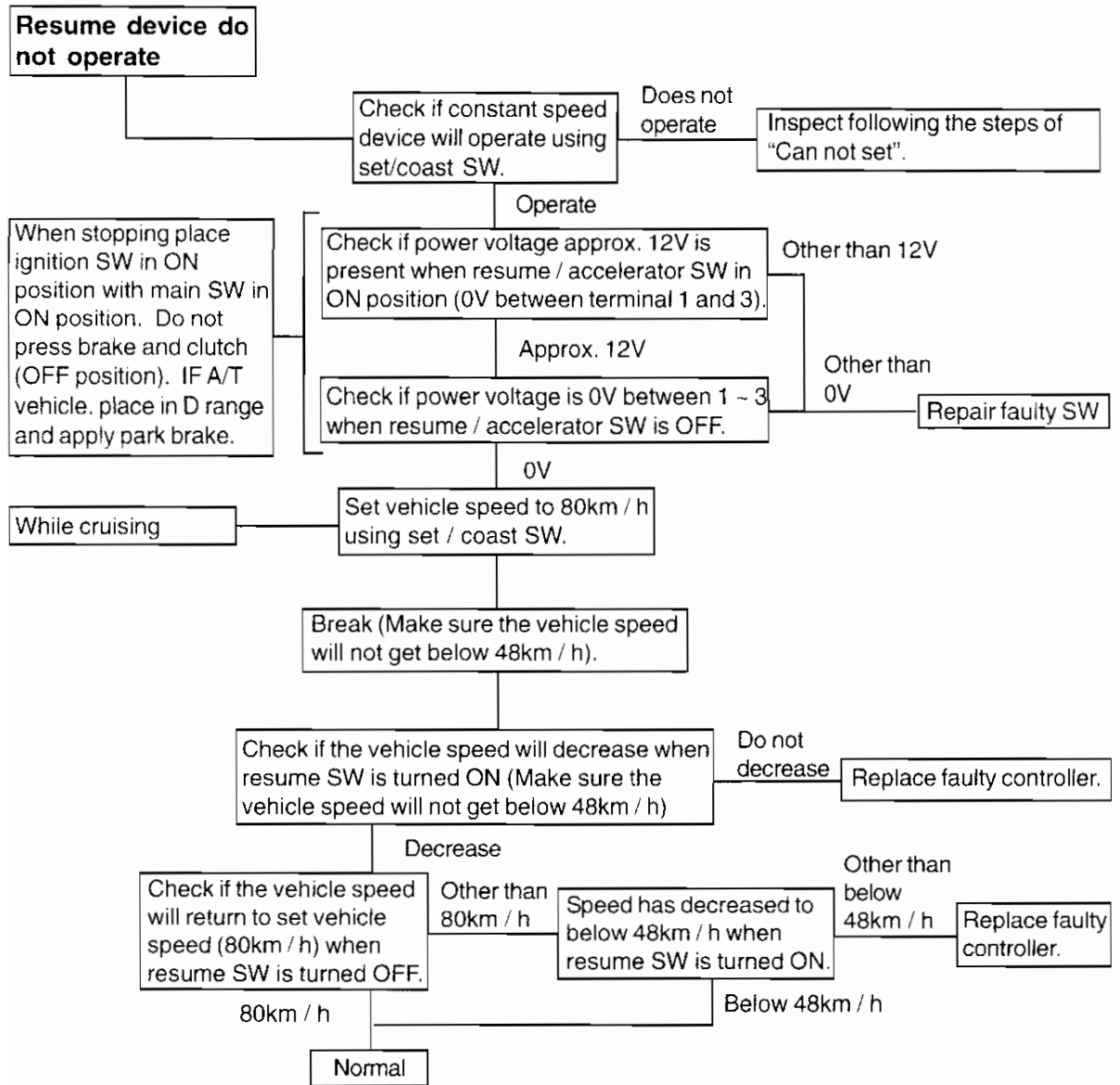

**INSPECTION & MAINTENANCE PROCEDURE WHEN IT CAN NOT BE CANCELLED**

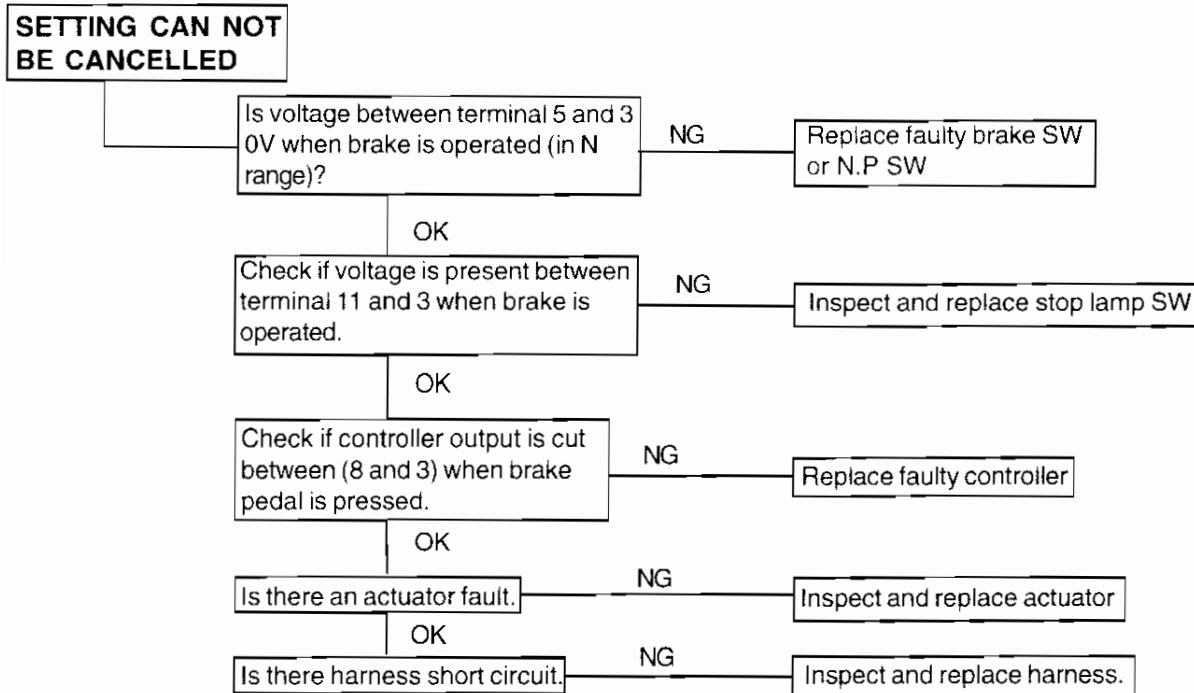

**(2) FUNCTION INSPECTION**

- ASCD function inspection is carried out by driving the vehicle and checking if each function will operate normally. In this function inspection ASCD control circuit system function is inspected using free roller.

Caution:

Constant drive can not be achieved by ASCD as it is non-load drive on the free roller. Use (1) fault diagnosis as a reference depending on each problem when carrying out fault diagnosis.

- Turn ON the main switch when ignition switch is placed in ON position and check that operation lamp will turn on.

Caution:

There is a fault with main switch or ASCD relay if the lamp does not turn on.

- Check that the cruise lamp will turn on when driving at a constant speed (60 km/h) and set / coast switch is placed to ON position. Check if the vehicle speed will increase for a moment, cruise lamp will turn off and constant drive can not be achieved when accelerator pedal is released and set / coast switch is placed to OFF position at the same time.

Caution:

If ASCD circuit is normal, hunting will occur and ASCD will be cancelled as it is non-load drive.

- Check that the cruise lamp will not turn on when set switch is pressed when the brake pedal is pressed slightly (brake switch: OFF, stop lamp switch: ON), driving at a constant speed (60 km / h). Make sure the vehicle speed will not increase when the accelerator pedal is released and set switch is placed to OFF position at the same time (release function inspection).

**(3) COMPONENT PARTS INSPECTION**

**Controller inspection**

- Extract the controller by removing controller bolts. Inspect ASCD control system using controller connector parts. If diagnosis result is faulty replace the controller unit.

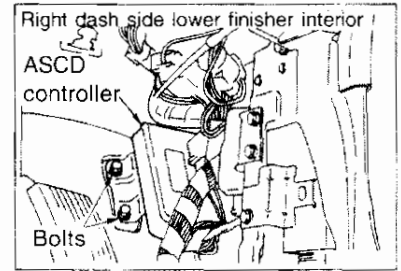

**Controller (ground circuit) inspection**

- Check the continuity between terminal 3 and body ground with connector connected.

Between terminal 3 and body ground	Continuity present
------------------------------------	--------------------

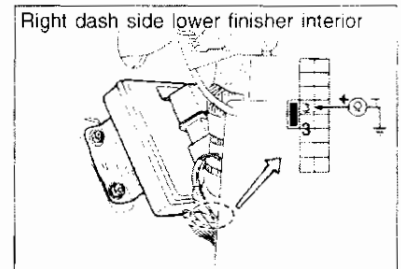

**Controller (power circuit) inspection**

- Inspect power voltage between following terminals with connectors connected.

Ignition switch	ON position		
	ON		OFF
Main switch			
Pedal operation	Brake or clutch pedal is pressed	Brake and clutch pedal not pressed	-
4(+) ~ 3(-)	Approx. 12V	Approx. 12V	0V
5(+) ~ 3(-) (Select lever other than P or N for A/T)	0V	Approx. 12V	0V

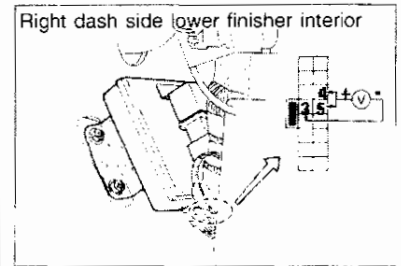

**Controller (cancel power supply input) inspection**

- Measure the voltage between terminal 11 and 3 when connectors are connected.

Ignition switch	ON position	
	Brake pedal pressed	Brake pedal not pressed
11(+) ~ 3(-)	Approx. 12V	0V

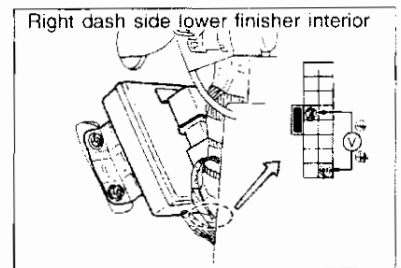

**Controller (set / coast switch input) inspection**

- Place ignition switch to ON position. Measure the voltage between terminal 1 and 3 with connectors connected.

Main switch	ON position		OFF position
	Pressed	Pressed and released	-
11(+) ~ 3(-)	Approx. 12V	0V	0V

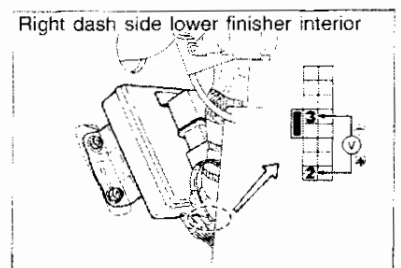

**Controller (resume / accelerator switch input) inspection**

- Place ignition switch to ON position and measure the power voltage between terminal 1 and 3 with connectors connected.

Main switch	ON position		OFF position
Resume / accelerator switch	ON	OFF	-
1(+) ~ 3(-)	Approx. 12V	0V	0V

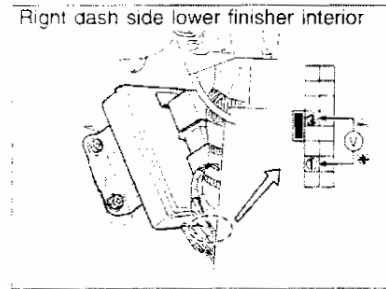

**Controller (vehicle speed sensor output) inspection**

- Slowly rotate the rear wheels and measure the voltage between terminal 7 and 3 with connectors connected.

7(+) ~ 3(-)	Approx. 5V and 0V alternatively
-------------------	---------------------------------

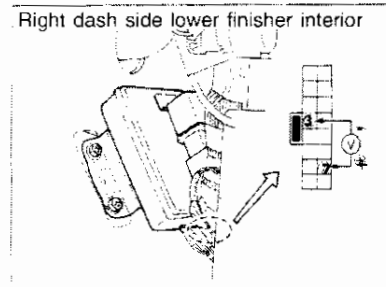

**Controller (cruise lamp output) inspection**

- Measure the voltage between terminal 13 and 3 with connectors connected.

Terminal	Drive at ASCD setting possible vehicle speed with main switch and set switch in ON position, also driving with ASCD set	Others
13(+) ~ 3(-)	Approx. 12V	0V

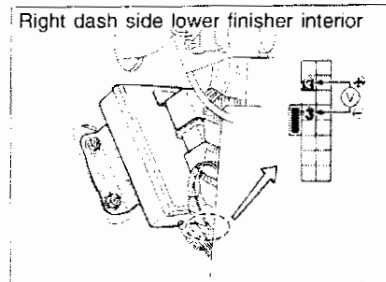

**Controller (A/T control unit control output) inspection [A / T vehicle]**

- Drive (ASCD set possible range) and measure the voltage between terminal 12 and 3 with connectors connected.

Terminal	Driving flat road with main switch ON	Accelerator switch is turned ON when ASCD set drive (RB20E, RB20DE)
12(+) ~ 3(-)	Approx. 6V	0V

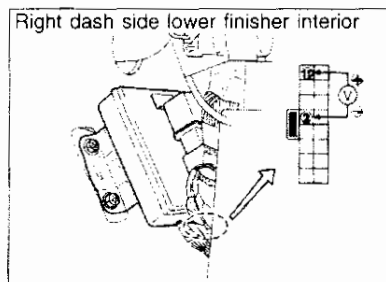

**Note:**

With A/T shift control, ASCD controller is prioritized when set at ASCD drive.

**Controller (valve output) inspection**

- Drive (ASCD set possible range) and measure the voltage between terminal 8 and 3 with connectors connected.

Terminal	Drive at ASCD setting possible vehicle speed with main switch ON and set switch is pressed and released, also accelerator switch is pressed	Others
8(+) ~ 3(-)	Approx. 12V	0V

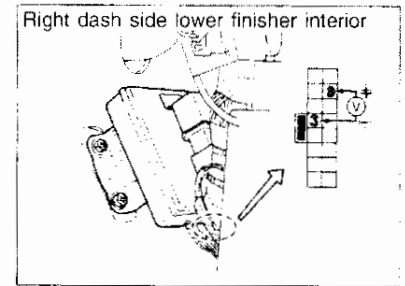

**Main switch inspection**

- Remove harness connectors and check the continuity between following terminals on main switch side connectors.

Switch position Terminals	ON	N	OFF
1 ~ 2	Continuity present	No continuity	No continuity
2 ~ 3	Continuity present	No continuity	No continuity
1 ~ 3	Continuity present	No continuity	No continuity
1 ~ 4	Continuity present	No continuity	No continuity
2 ~ 4	Continuity present	Continuity present	No continuity
3 ~ 4	Continuity present	Continuity present	Continuity present
5 ~ 6	Continuity present	Continuity present	Continuity present

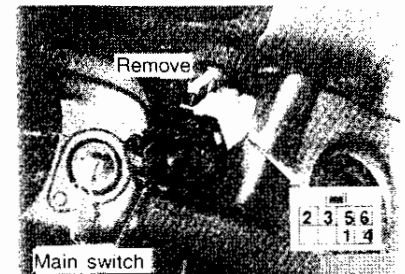

**Set / coast, resume / accelerator & cancel switch inspection**

- Remove horn pad and harness connector. Operate each switch and check continuity between following terminals.

Terminals	Operation	Switch pressed	Switch not pressed
1 ~ 2 (set / coast switch)		Continuity present	No continuity
1 ~ 3 (set / accelerator switch)		Continuity present	No continuity
1 ~ 2 (cancel switch)		Continuity present	No continuity
1 ~ 3 (cancel switch)		Continuity present	No continuity

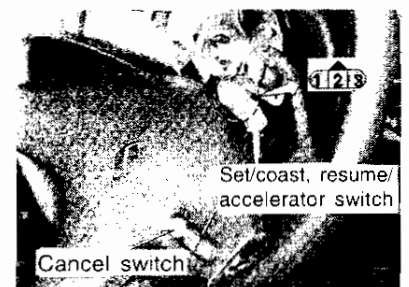

**Brake, clutch & stop lamp switch inspection**

- Disconnect harness connector and operate each switches to inspect continuity between following terminals.

Switch	Operation	Pressed (Pedals not pressed)	Not pressed (Pedals pressed)
Brake and clutch switch		Continuity present	No continuity
Stop lamp switch		No continuity	Continuity present

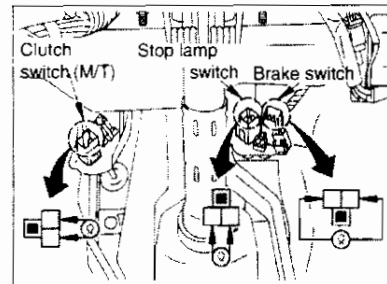

**ASCD relay inspection**

- Remove ASCD relay and directly apply battery voltage between terminal 1 and 2. Check the continuity between terminal 3 and 5.

Terminals	Electricity not conducted	Electricity conducted
3 ~ 5	No continuity	Continuity present

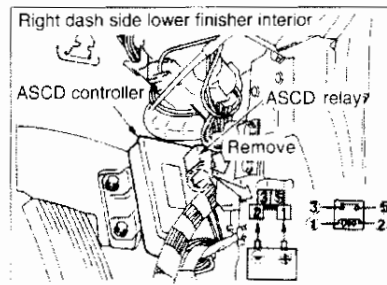

**Clutch relay inspection (HICAS M/T vehicles)**

- Check the continuity between following terminals when battery voltage is directly applied between terminal 1 and 2.

Terminals	Electricity not conducted	Electricity conducted
3 ~ 5	No continuity	Continuity present
3 ~ 4	Continuity present	No continuity

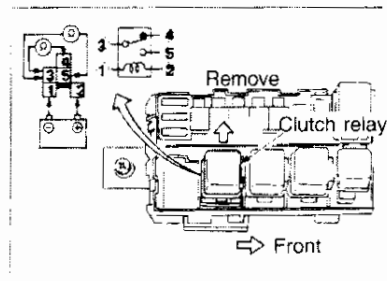

**Inhibitor (N.P) relay inspection (A/T)**

- Check the continuity between following terminals when battery voltage is directly applied between terminal 1 and 2.

Terminals	Electricity not conducted	Electricity conducted
6 ~ 7	No continuity	Continuity present
3 ~ 4	Continuity present	No continuity

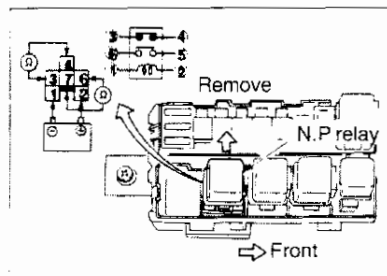



**ASCD pump inspection**

- Remove connector terminals. Check the motor operation by directly applying battery voltage between terminal 1 and 4.

Apply battery voltage between terminal 1 and 4	Motor will operate
--	--------------------

**Resistance inspection**

Terminals	Resistance $\Omega$
Air valve 1 ~ 4	Approx. 70
Release valve 1 ~ 2	Approx. 70
Vacuum pump 1 ~ 3	Approx. 8

**Operation inspection**

- Apply battery voltage between terminal 1(+) and 3(-) and check if ASCD wire will operate when terminal 4 and 2 is grounded.

**ASCD wire adjustment**

- Loosen lock nuts so ASCD wire has adequate slack. Pull outer case in direction of actuator from position where throttle drum starts operating, return lock nuts approximately 1 turns and tighten securely.

Lock nut tightening torque (kg-m)	0.8 ~ 1.0
-----------------------------------	-----------

**RB20E**

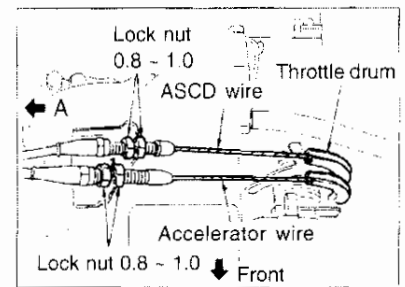

**RB20DE / DET**

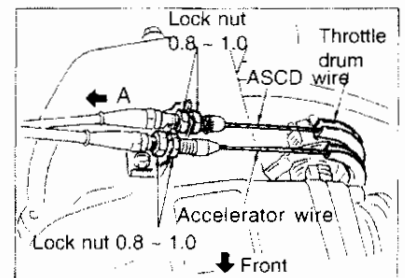

# ENGINE MOUNTING

## FRONT ENGINE MOUNTING

### (1) CA18i ENGINES

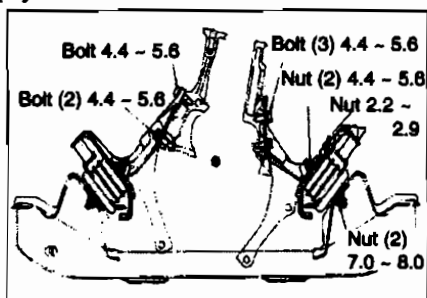

### (2) RB ENGINES

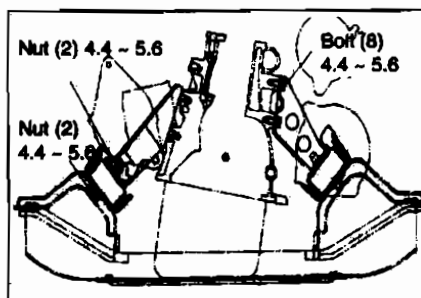

## REAR ENGINE MOUNTING

### (1) CA18i ENGINES

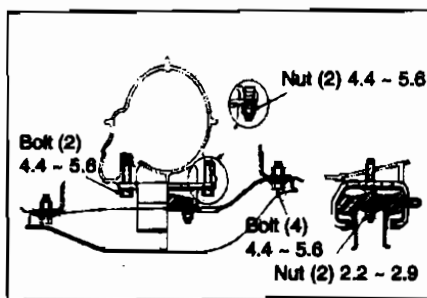

### (2) RB ENGINES

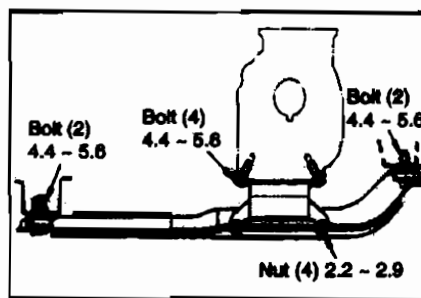

# Index

## Symbols

2-pole lift .....	GI - 13
4WD inspection .....	GI - 15
4WD repair precautions .....	GI - 15

## A

A / T control (RB25DE) .....	EN - 421
AAC valve .....	EN - 274, 443, 484
Active test .....	EN - 270
Actuator system inspection .....	EN - 302
Air cleaner element .....	EN - 49, 58, 151
Air conditioner relay .....	EN - 433
Air conditioner signal .....	EN - 399
Air duct & air cleaner .....	EN - 151
Air flow meter .....	EN - 407, 482
Air flow meter sensor (RB20) .....	EN - 361, 363
Air regulator .....	EN - 275, 445, 485
Alternator .....	EN - 530
ASCD .....	EN - 547
Automatic temperature adjustment .....	EN - 51

## B

Balance tube .....	EN - 68
Basic inspection .....	EN - 236, 272
Battery inspection .....	EN - 530
Belt tension .....	EN - 43
Blowby control valve .....	EN - 55, 489
Blowby gas reduction device .....	EN - 55
Blowby hose .....	EN - 489
Board-on Lift .....	GI - 13
Braking perform check .....	GI - 15

## C

Catalytic converter .....	EN - 543
Circuit diagram .....	EN - 279
Collector ASSY .....	EN - 59, 105, 106, 115
Components inspection (RB25DE) .....	EN - 482
Compression pressure inspection .....	EN - 42
Conical washer .....	EN - 80
Connector installation .....	EN - 233
Connector symbol .....	GI - 6
CONSULT .....	GI - 11
CONSULT display screen .....	EN - 265
Crank angle sensor .....	EN - 355, 356, 404, 442
Cylinder head .....	EN - 83, 85, 170

## D

Data monitor .....	EN - 267
Deceleration exh gas emission control ...	EN - 527
Detonation sensor .....	EN - 381, 382, 417
Diagnosis chart by phenomenon .....	EN - 240
Diagnosis procedure .....	EN - 234
Diagnostic system .....	EN - 259
Diagnostic worksheet .....	EN - 234
DOHC .....	EN - 274

## E

ECCS .....	EN - 231
ECCS C/U installation .....	EN - 233
ECCS relay (RB25DE) .....	EN - 485
ECCS voltage .....	EN - 233
Emission control equipment .....	EN - 7
Engine control .....	EN - 546
Engine electrical equipment .....	EN - 529
Engine mounting .....	EN - 560
Engine overhaul .....	EN - 186
Engine specifications .....	EN - 7
Engine stall .....	EN - 254
Engine temperature sensor ...	EN - 367, 396, 482
Evaporative gas control .....	EN - 54, 488
Exhaust gas sensor .....	EN - 386, 390, 392, 415
Exhaust gas sensor heater .....	EN - 434
Exhaust gas temp warning equipment ....	EN - 545
Exhaust manifold .....	EN - 159
Exhaust manifold ASSY ...	EN - 75, 109, 119, 142
Exhaust pipe .....	EN - 543
Exhaust system .....	EN - 49, 542

## F

Front turbocharger ASSY .....	EN - 69
Fuel gauge .....	EN - 539
Fuel injector .....	EN - 156
Fuel pressure inspection .....	EN - 53
Fuel pump .....	EN - 303, 307, 440, 483
Fuel system .....	EN - 52, 486, 537
Fuel tank .....	EN - 537
Fuel tank vacuum releaf valve .....	EN - 54
Fuel tube ASSY .....	EN - 66

## G

Gas leak inspection .....	EN - 75
General precautions .....	GI - 7

## H

Heater panel .....	EN - 543
How to use this manual .....	GI - 2
Hydraulic Jack lifting .....	GI - 14

## I

Idle mixture ratio .....	EN - 23
Idle speed control system .....	EN - 339, 346
Idle speed inspection .....	EN - 23
Ignition coil .....	EN - 483, 532
Ignition inspection .....	EN - 328
Ignition relay .....	EN - 486
Ignition signal .....	EN - 424
Ignition system .....	EN - 330, 332, 412
Ignition timing inspection .....	EN - 23
Individual system inspection .....	EN - 237
Inhibitor relay .....	EN - 486
Injector .....	EN - 314, 317, 323, 484

Input signals and control items .....	EN - 239
Inspection points .....	GI - 16
Intake air temperature sensor .....	EN - 378
Intake manifold .....	EN - 65, 107, 117, 137, 157
Intake manifold collector .....	EN - 153
Intake manifold vacuum .....	EN - 275
Intercooler .....	EN - 57, 131
Intercooler air duct assembly .....	EN - 56
Intercooler inlet hose .....	EN - 56

## J

Jack stand support .....	GI - 14
--------------------------	---------

## L

Lock up release control system .....	EN - 353
Locker cover .....	EN - 110, 143
Lubrication oil level .....	EN - 47
Lubrication system inspection .....	EN - 47

## M

Measurement tools .....	EN - 12
Multipurpose tools .....	EN - 12

## N

Neutral switch signal .....	EN - 399
No. 1 cylinder pressure T.D.C .....	EN - 78

## O

O-ring .....	EN - 66
Oil & cooling water inlet and outlet .....	EN - 73
Oil cooler .....	EN - 99
Oil filter .....	EN - 48, 99, 129, 149
Oil pan .....	EN - 129, 149, 165
Oil pressure .....	EN - 48
Oil pump bolt .....	EN - 102
Oil seal .....	EN - 166
Oil strainer .....	EN - 100, 129
On-vehicle parts .....	EN - 56
Operation support .....	EN - 271
Operational sequence .....	GI - 3

## P

Platinum plug inspection .....	EN - 531
Poor drivability .....	EN - 251
Poor idling .....	EN - 247
Power steering hydraulic pressure ...	EN - 447, 486
Power supply & ground circuit .....	EN - 401
Power transistor .....	EN - 483
Problem confirmation .....	EN - 235
PTC heater control system .....	EN - 352
Purge control valve .....	EN - 54

## R

Radiator cap inspection .....	EN - 534
Radiator inspection .....	EN - 534
Rear turbocharger ASSY .....	EN - 70
Recirculation hose .....	EN - 57
Recirculation valve inspection .....	EN - 50, 57
Remove and install engine .....	EN - 180
Rocker cover .....	EN - 76, 120, 169

## S

Self-diagnosis .....	EN - 236, 262
Sensor system inspection .....	EN - 354
Six in-line throttle chamber .....	EN - 63
Spark inspection .....	EN - 274
Spark plug .....	EN - 76, 121, 486
Special service tools .....	EN - 8
Speedometer measurement .....	GI - 15
Start signal .....	EN - 436
Starter motor .....	EN - 531
Sub electrical fan inspection .....	EN - 536
Swing valve controller .....	EN - 73
System diagram .....	EN - 13
System figure .....	EN - 279

## T

Tensioner spring .....	EN - 80
Thermo-wax inspection .....	EN - 53
Thermostat .....	EN - 98, 127, 148, 536
Throttle body ASSY .....	EN - 139
Throttle sensor .....	EN - 371, 373, 419, 484
Throttle valve switch .....	EN - 367, 436, 483
Tightening Torque .....	GI - 13
Timing belt .....	EN - 78, 82, 111, 122, 144, 160
Towing .....	GI - 13
Trouble diagnosis .....	EN - 231
Turbocharger ASSY .....	EN - 68
Turbocharger failure diagnosis .....	EN - 74
Turbocharger inspection .....	EN - 49
Turbocharger unit inspection .....	EN - 71, 134

## U

Unable to start .....	EN - 239, 42
Unstable idling .....	EN - 234

## V

Vacuum diagram .....	EN - 19
Valve clearance inspection .....	EN - 45
Vehicle identification plate location .....	GI - 10
Vehicle speed sensor .....	EN - 397, 430

## W

Wastegate valve control .....	EN - 350
Water bypass connector .....	EN - 67
Water outlet elbow .....	EN - 67
Water pump .....	EN - 96, 126, 147