

NISSAN

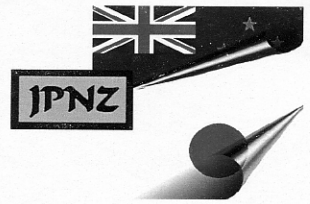

**R33 ENGINE MANUAL. RB20E, RB25DE, RB25DET &
RB26DETT**

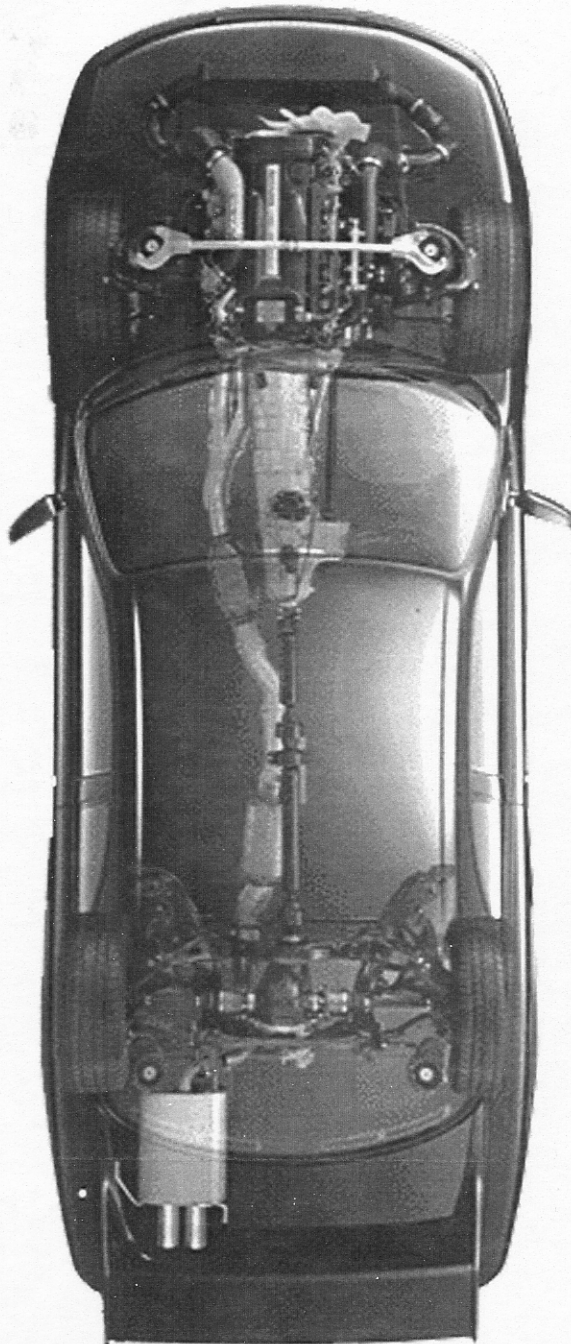

R33 ENGINE SERVICE MANUAL



JPNZ ENTERPRISES INTERNATIONAL

JPNZ ENTERPRISES INTERNATIONAL

**P.O. BOX 20-002 GLEN EDEN
AUCKLAND NEW ZEALAND**

PHONE: 64 9 813 3552 FAX 64 9 818 4651

E MAIL: manuals@jpnz.co.nz

www.jpnz.co.nz

THIS MANUAL IS A RECONSTRUCTION OF THE ORIGINAL JAPANESE VERSION.

MATERIAL HAS BEEN DELETED, WITH OTHER MATERIAL INCLUDED TO ENHANCE DIFFERENT DRIVING CONDITIONS FROM WHERE THIS VEHICLE WAS PRODUCED.

JPNZ ALSO OFFERS OTHER SERVICES SUCH AS RECREATIONS OF OTHER MATERIAL OFTEN FOUND AROUND YOUR VEHICLE, WHICH IS NOT UNDERSTANDABLE.

ALTHOUGH EVERY STEP WAS TAKEN TO PUBLISH CORRECT INFORMATION IN THIS MANUAL, NO OBLIGATION WILL BE TAKEN FROM EITHER THE RETAILER OR PUBLISHER.



JPNZ ENTERPRISES INTERNATIONAL

www.jpnz.co.nz

ALL RIGHTS RESERVED. NO PART OF THIS PUBLICATION MAY BE REPRODUCED, STORED IN A RETRIEVAL SYSTEM, TRANSMITTED IN ANY FORM OR BY ANY OTHER MEANS, ELECTRONIC, MECHANICAL, PHOTOCOPYING, RECORDING OR OTHERWISE, WITHOUT THE PRIOR PERMISSION IN WRITING FROM THE PUBLISHERS.

JPNZ ENTERPRISES INTERNATIONAL

**P.O. BOX 20-002 GLEN EDEN
AUCKLAND NEW ZEALAND**

PHONE: 64 9 813 3552 FAX 64 9 818 4651

E MAIL: manuals@jpnz.co.nz



SECTION **GI** GENERAL INFORMATION

CONTENTS

HOW TO USE THIS MANUAL GI - 2

SYMBOLS GI - 5

GENERAL PRECAUTIONS GI - 7

VEHICLE & UNIT IDENTIFICATION LOCATION GI - 10

CONSULT GI - 11

TIGHTENING TORQUE OF STANDARD BOLTS GI - 12

TOWING GI - 13

GARAGE JACK & RIGID RACK SUPPORT POSITION GI - 14

ABBREVIATION GI - 15

MAIN UNIT CONVERSION GI - 16

4WD INSPECTION & REPAIR PRECAUTIONS GI - 17



HOW TO USE THIS MANUAL

MAINTENANCE OPERATION EXPLANATION

This manual describes important items for installation, removal, assembly, inspection, repair and failure diagnosis.

Caution:

A general description of a visual inspection and cleaning of disassembled parts has generally been omitted. However, when reusing the parts, make sure to perform visual inspection and cleaning as necessary.

CONFIGURATION COMPONENTS, OPERATION CONTENTS & PROCEDURES

The configuration components, operation contents and procedures are shown after the title of each operation. Preparation standards and important operation points such as parts which can not be used again, tightening torque and lubrication locations are also indicated.

Configuration components & Operation contents

The operations for installation, assembly and disassembly are indicated by the part name. This description is used when the ideal procedure can not be determined or there are many types of components.

[Point] is used to indicate the operation procedures which are necessary.

Example: Front Axle disassembly & assembly

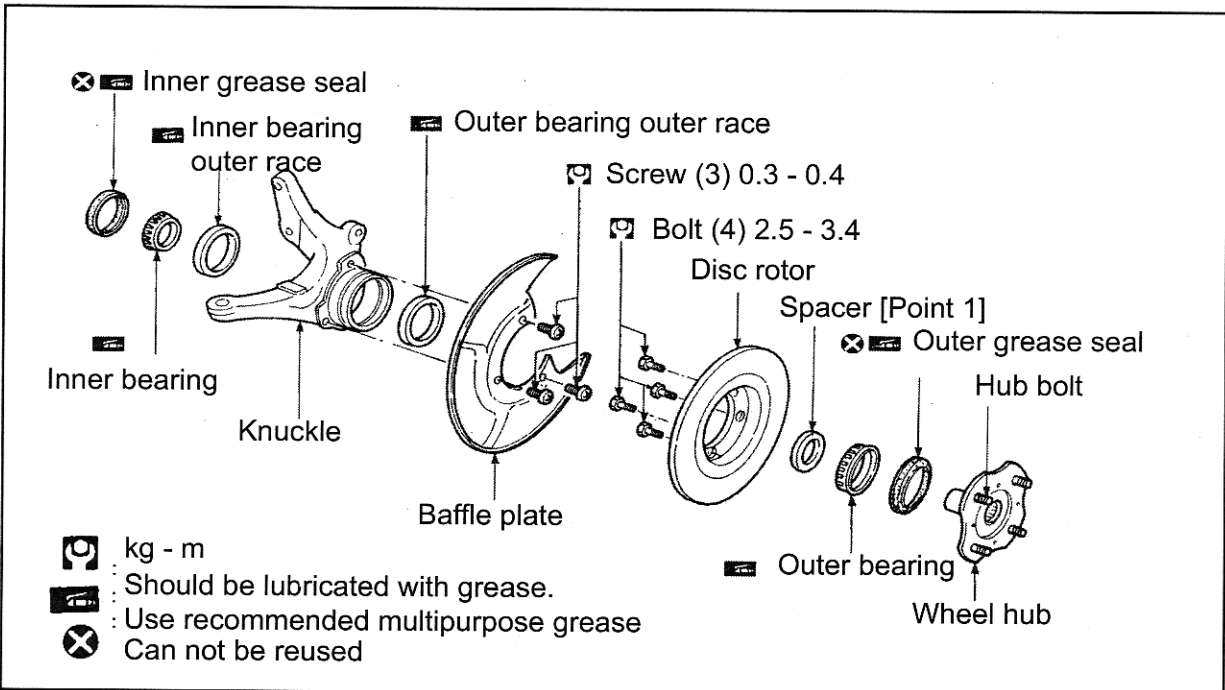

Unit definition

The unit of measure used in this manual for tightening torque is described in "SI measure (International unit)" and the units within { } is in meter unit.

Example: Tightening torque: 59 - 78 N-m {6.0 - 8.0 kg-m}

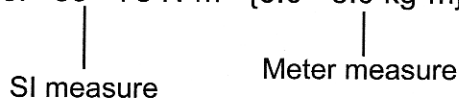







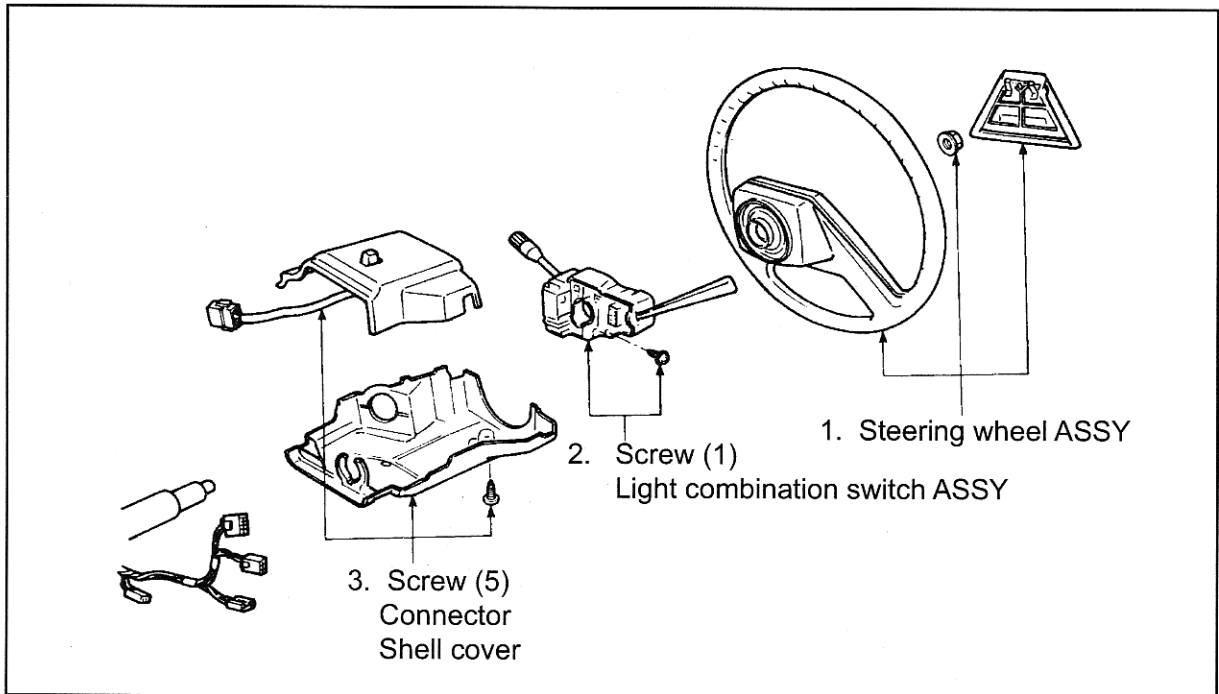

STRUCTURAL PARTS DIAGRAM AND OPERATIONAL SEQUENCE

The name of the parts required for the operations are shown. The operation sequence must be followed in the order shown.

Assembly is the reverse of disassembly except when otherwise indicated.

Example 1: Light combination switch ASSY installation and removal



SYMBOLS	DESCRIPTION
	Operation where the torque should be checked and standard torque value should be used. When X to Y N.m (kg-m. ft-lb) is indicated, the standard tightening torque indicated is the median value.
	Should be lubricated. Indicates a type of grease used.
	Parts that can not be reused.
	Should be lubricated with oil.
	Sealing point.
	Select genuine parts.
	Adjust parts.
	Parts need to be checked visually.

Example 2: Fault diagnosis flow chart

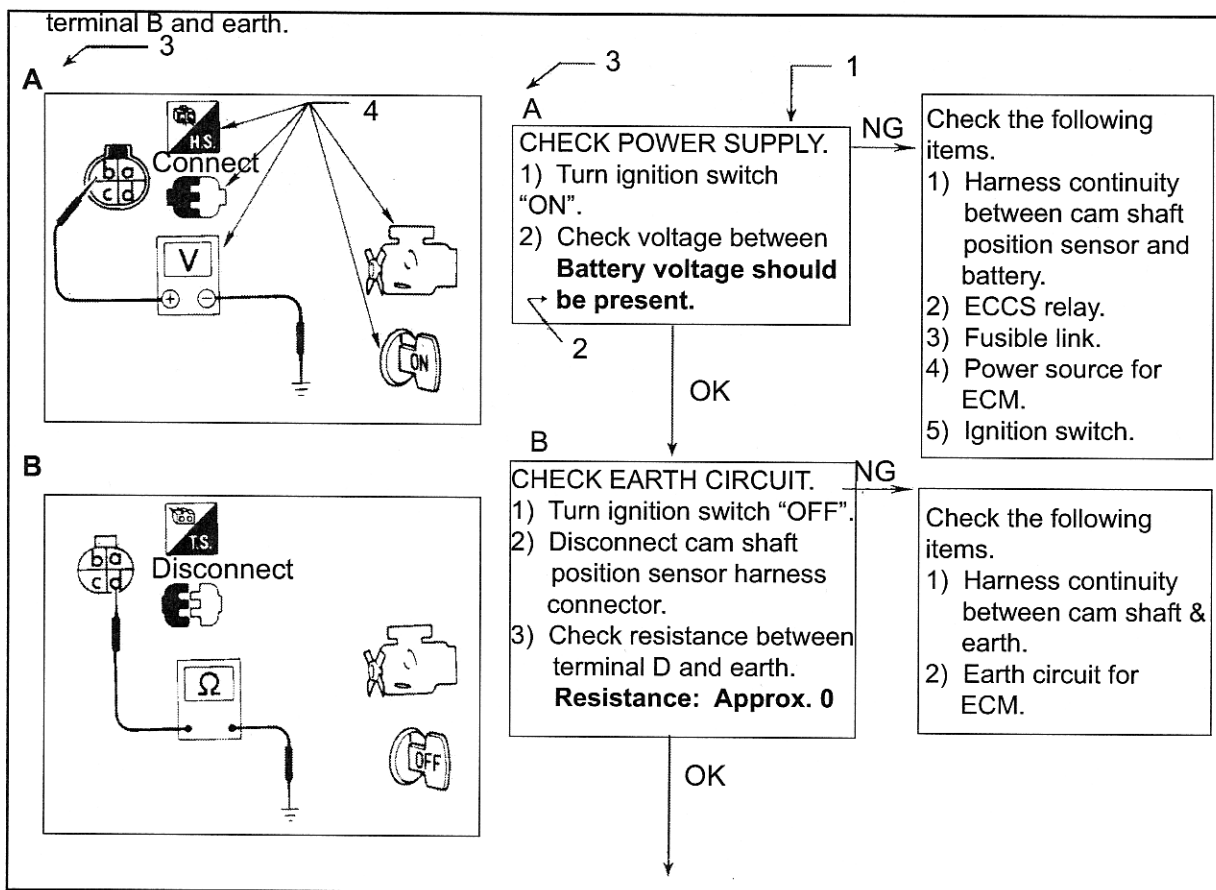

HOW TO FOLLOW THIS FLOW CHART

1. Work and diagnostic procedure

Start to diagnose a problem using procedures indicated in enclosed blocks, as shown in the following example.

A

CHECK POWER SUPPLY.
 1) Turn ignition switch "ON".
 2) Check voltage between terminal B and earth.
Battery voltage should exist.

← Check item being performed.

— Procedure, steps or measurement results.

2. Measurement results

Required results are indicated in bold type in the corresponding block, as shown below.

These have the following meanings:

Battery voltage; 11 - 14V or approximately 12V





















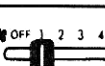

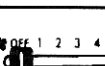









Voltage; Approximately 0V - Less than 1V

3. Cross reference of work symbols in the text and illustrations

Illustrations are provided as visual aids for work procedures.

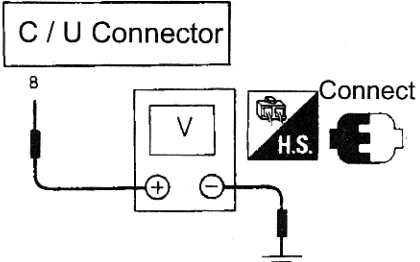
4. Symbols used in illustrations

Symbols included in illustrations refer to measurements or procedures. Before diagnosing a problem, familiarize yourself with each symbol.

Symbol	Symbol explanation	Symbol	Symbol explanation
	Check after disconnecting the connector to be measured.		Current should be measured with an ammeter.
	Check after connecting the connector to be measured.		Procedure with CONSULT.
	Insert key into ignition switch.		Procedure without CONSULT.
	Remove key from ignition switch.		A / C switch is "ON".
	Turn ignition switch to "OFF" position.		A / C switch is "OFF".
	Turn ignition switch to "ON" position.		Fan switch is "ON".
	Turn ignition switch to "START" position.		Fan switch is "OFF".
	Turn ignition switch from "OFF" to "ACC" position.		Apply fused battery positive voltage directly to components.
	Turn ignition switch from "ACC" to "OFF" position.		Drive vehicle.
	Turn ignition switch from "OFF" to "ON" position.		Disconnect battery negative cable.
	Turn ignition switch from "ON" to "OFF" position.		Depress brake pedal.
	Do not start engine, or check with engine stopped.		Release brake pedal.
	Start engine, or check with engine running.		Depress accelerator pedal.
	Apply parking brake.		Release accelerator pedal.
	Release parking brake.	<p>Pin terminal check for ECM and A/T control unit connectors.</p> 	
	Check after engine is warmed up sufficiently.		
	Voltage should be measured with a voltmeter.		
 	Circuit resistance should be measured with an ohmmeter.		

CONNECTOR SYMBOL

A direction mark is shown to clarify the side of connector (terminal side or harness side).

- Connector symbols shown from the terminal side are enclosed by a single line.

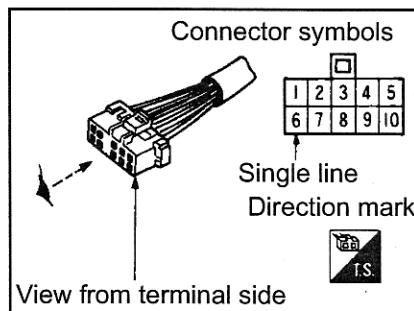

- Connector symbols shown from the harness side are enclosed by a double line.

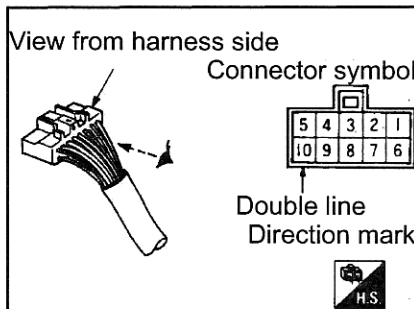

Male & Female terminals

Connector guides for male terminals are shown in black and female terminals in white in wiring diagrams.

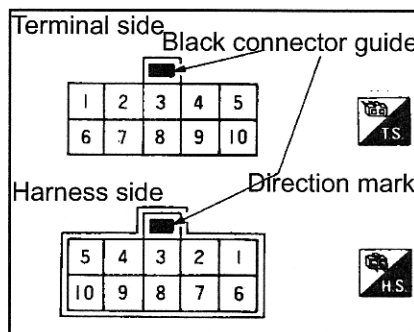

Control unit element substances

Elements such as control unit will be shown as displayed.

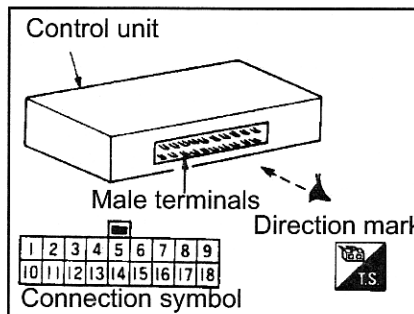

GENERAL PRECAUTIONS

Follow the below precautions to ensure safe & proper servicing for your vehicle.

SRS (Supplemental Restrain System) air bag

- Information necessary to service the system safely and correctly is included throughout this service manual. Make sure you read each section carefully before carrying out maintenance operation.
- Improper maintenance, including incorrect removal and installation of the SRS air bag, can lead to personal injuries caused by unintentional activation of the system.
- Do not use electrical test equipment on any circuit related to the SRS air bag.
- All SRS electrical wiring harnesses and connectors are covered with yellow outer insulation.

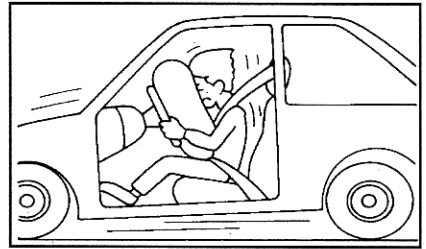

General Precautions

- Do not operate the engine for an extended period of time without proper exhaust ventilation.
- Keep the work area well ventilated and free of any flammable materials.
- Care must be taken when handling any flammable or poisonous materials.

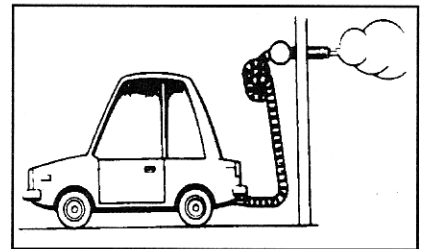

- Before servicing the vehicle, cover fenders, upholstery and carpeting with appropriate covers.

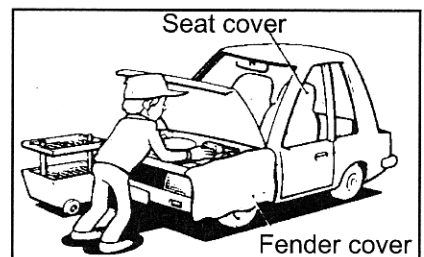

- Before jacking up the vehicle, apply wheel stoppers and only jack up the vehicle at jack up point.
- After jacking up the vehicle, support the vehicle weight with safety stands before working on the vehicle.
- When removing heavy objects such as the engine or transaxle / transmission, take care not to drop them. Also, do not allow them to strike other parts, especially the brake tube and master cylinder.

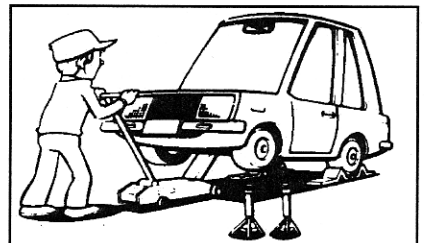

- Before start repairs that do not require battery power, always turn off the engine and disconnect the earth cable from the battery to prevent accidental short circuit.
- Loosen the screw nut completely when removing the earth cable from the battery.

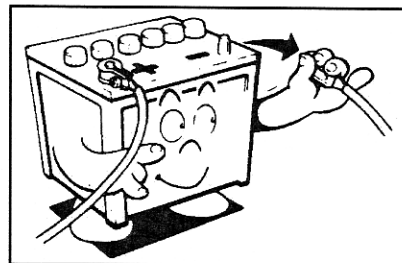

- To prevent serious burns, avoid contact with hot metal part such as the radiator, exhaust manifold, tail pipe and muffler. Carry out the operation when the parts has cooled down.
- Do not remove the radiator cap when the coolant is hot.

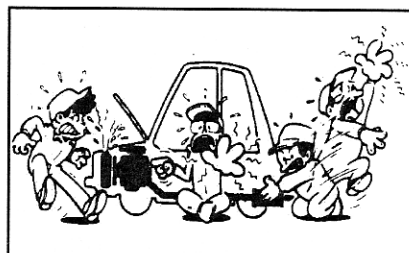

- An inspection may be difficult with a normal test probe when a connector pin is extremely small. When this is the case, wind a small pin or wire around the test probe, or sharpen the end of the probe to perform the inspection.
- Use measurement equipment such as the CONSULT electronic system diagnosis tester and an oscilloscope to perform diagnosis operation.
- Check the vehicle damage carefully, make a careful diagnosis of the damage and perform the correct operation.
- Check the correct part assembly condition before removal or disassembly. Make alignment marks when necessary in locations which will not interfere with the part operation.
- When replacing parts always use correct specified parts or tools.
- Replace oil seals, gaskets, packing, O-rings, locking washers, cotter pins, self locking nuts, etc. with new ones. These parts are indicated "Can not be reused" and must be replaced with new parts.
- Always replace taper-roller bearing and the needle bearing for inner and outer race as a set.
- Take care not to mix up the removed parts.
- When replacing parts always use genuine Nissan replacement parts.
- Use correct lubricants specified.
- Dispose waste oil and cleaning oil in a way that is set by the law.

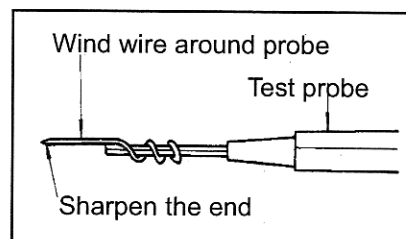

Precautions for ECCS engine

- Before connecting or disconnecting ECCS control module harness connector, be sure to turn the ignition switch to the "OFF" position and disconnect the negative battery terminal.
- Release fuel pressure to eliminate danger before disconnecting pressurized fuel line from fuel pump to injectors.
- Do not apply any shock to the electric parts such as ECCS control unit or Airflow metre.
- Use measurement equipment to perform diagnosis operation.

**Precautions for Catalyst converter**

If a large amount of unburnt fuel flows into the converter, the temperature within the converter will become excessively high. To prevent this, follow the procedure below:

- Only carry out the ignition spark or measuring engine compression checks when necessary and carry out the tests quickly.
- Do not run the engine when the fuel tank level is low, otherwise the engine may misfire causing damage to the converter.
- Only use specified gasoline.
- Do not place burnable objects below the vehicle. Keep flammable material off the exhaust pipe and the catalyst converter.

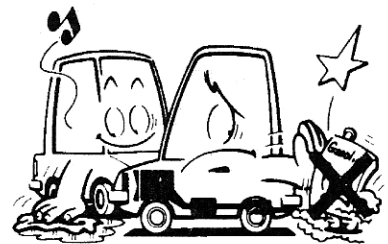
**Precautions for fuel**

Only use unleaded gasoline for gasoline engine vehicle. Using a fuel other than that specified could damage the vehicle.

VEHICLE & UNIT IDENTIFICATION PLATE LOCATION

Vehicle identification number (Supplement models only)

E-HR33.....HR33-000101~
 E-ER33.....ER33-000121~
 E-ECR33.....ECR33-000151~

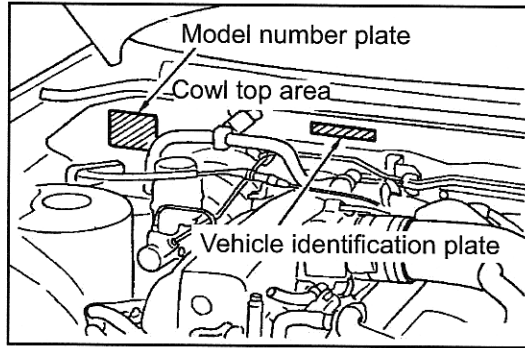

Model number plate

1. Type
2. Vehicle identification number
3. Model
4. Body colour code
5. Trim colour code
6. Engine model
7. Engine displacement
8. Transmission model
9. Axle model

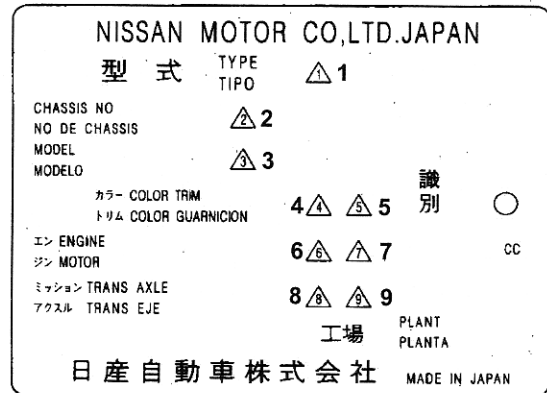

Engine serial number

RB Vehicles: Lower rear left cylinder block

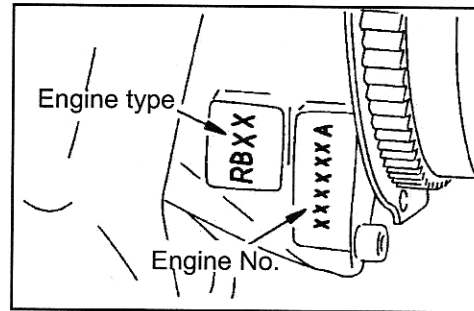

CONSULT

Consult is a hand-held compact type tester. It transmits signals to the vehicle loading control units when the diagnoses connector is connected and can perform all types of diagnosis and tests.

Note:

Refer to the CONSULT operation manual for further details.

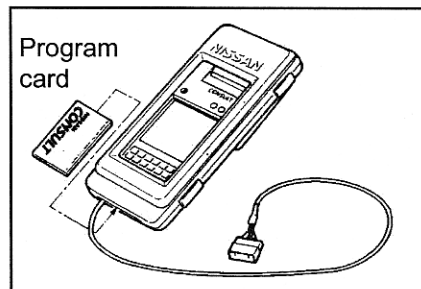
**FUNCTION**

Operation support	Transmits commands to the electrical control unit for setting the status suitable for required operation.
Function test	Diagnose the ECCS standard checks
Self-diagnosis	Receives the self-diagnosis results from the electrical control unit and displays malfunctioning system names and the number of times a malfunction occurs.
Data monitor	Receives input and output signals from the control unit, displays and records data used to easily determine cause of malfunction.
Active test	Sends commands to the control unit and performs the operation inspection and verification of the output system according to output signal changes.
ECU part unit	Displays the part number of the electrical control unit.

APPLICATION

	Engine (ECCS)	A / T	HICAS	ABS	ABS (with A-LSD)	SRS air bag
Operation support	○				○	
Function test	○					
Self-diagnosis	○	○	○	○	○	○
Data monitor	○	○	○	○	○	
Active test	○		○	○	○	
ECU part number	○	○	○	○	○	

TIGHTENING TORQUE OF STANDARD BOLTS

Grade	Bolt size	Bolt diameter (mm)	Pitch (mm)	Tightening torque (without lubricant)			
				Hexagon head bolt		Hexagon flange bolt	
				N-m	kg-m	N-m	kg-m
4T	M6	6.0	1.0	5.1	0.52	6.1	0.62
	M8	8.0	1.25	13	1.3	15	1.5
			1.0	13	1.3	16	1.6
	M10	10.0	1.5	25	2.5	29	3.0
			1.25	25	2.6	30	3.1
	M12	12.0	1.75	42	4.3	51	5.2
			1.25	46	4.7	56	5.7
M14	14.0	1.5	74	7.5	88	9.0	
7T	M6	6.0	1.0	8.4	0.86	10	1.0
	M8	8.0	1.25	21	2.1	25	2.5
			1.0	22	2.2	26	2.7
	M10	10.0	1.5	41	4.2	48	4.9
			1.25	43	4.4	51	5.2
	M12	12.0	1.75	71	7.2	84	8.6
			1.25	77	7.9	92	9.4
M14	14.0	1.5	127	13.0	147	15.0	
9T	M6	6.0	1.0	12	1.2	15	1.5
	M8	8.0	1.25	29	3.0	35	3.6
			1.0	31	3.2	37	3.8
	M10	10.0	1.5	59	6.0	70	7.1
			1.25	62	6.3	74	7.5
	M12	12.0	1.75	98	10.0	118	12.0
			1.25	108	11.0	137	14.0
M14	14.0	1.5	177	18.0	206	21.0	

Special parts are excluded.

This standard is applicable to bolts having the following marks embossed on the bolt head.

Grade	Mark
4T	4
7T	7
9T	9

TOWING

Front

After removing the front spoiler, attach a cable to the hook in the front part of the front side member.

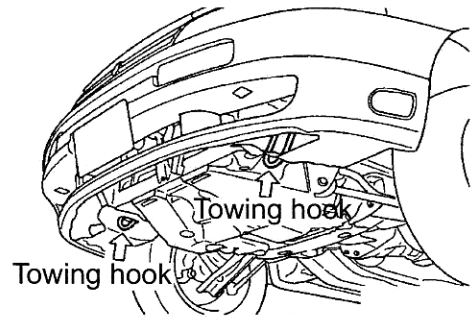

Rear

Attach a cable to the hook mounted at the rear part of the rear side member.

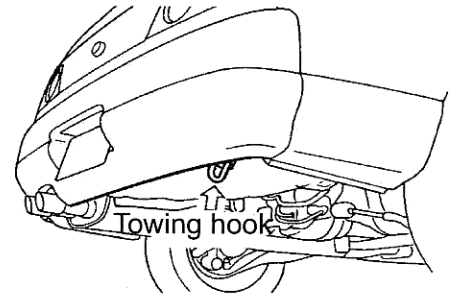

2-POLE LIFT

Set the lift pad to side sill jack up point.

Caution:

Make sure the vehicle is empty when lifting the vehicle.

Make sure the side sill and lift arm (rear part) do not contact each other when lifting the vehicle.

Front of the vehicle ←

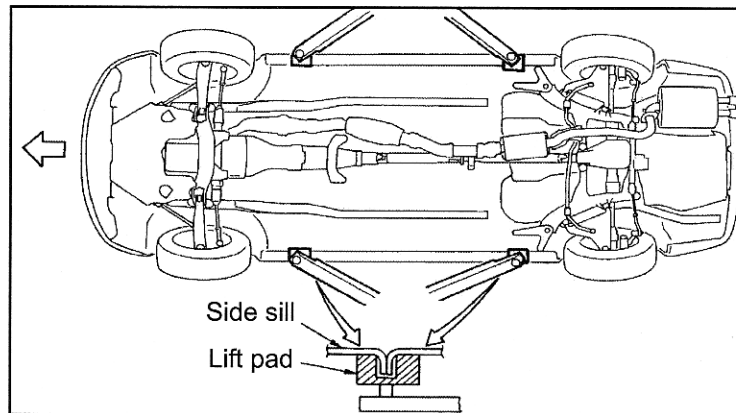

Board-on Lift

Set the board-on lift adapter (LM4086-0200) on both sides of the lift.

Standard set position is a jack up point located in front of the side sill, as the vehicle gravity point is located at the vehicle front.

Caution:

Make sure the vehicle is empty when lifting.

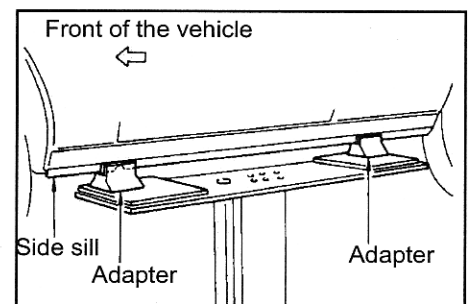

GARAGE JACK & RIGID RACK SUPPORT POSITION**Caution:**

- When using a garage jack to jack up the vehicle, care must be taken not to damage any pipes.
- Apply parking brake when jacking up the front of the vehicle.
- Place wheel stopper to front wheels when jacking up the rear of the vehicle.
- If the vehicle is jacked up for prolonged period, use rigid rack to support the vehicle.
- Always set the adapter (LM4519-0000) to the rigid rack and place it to jack up point on the side sill.
- Never place a rigid rack to the side member on the under floor.

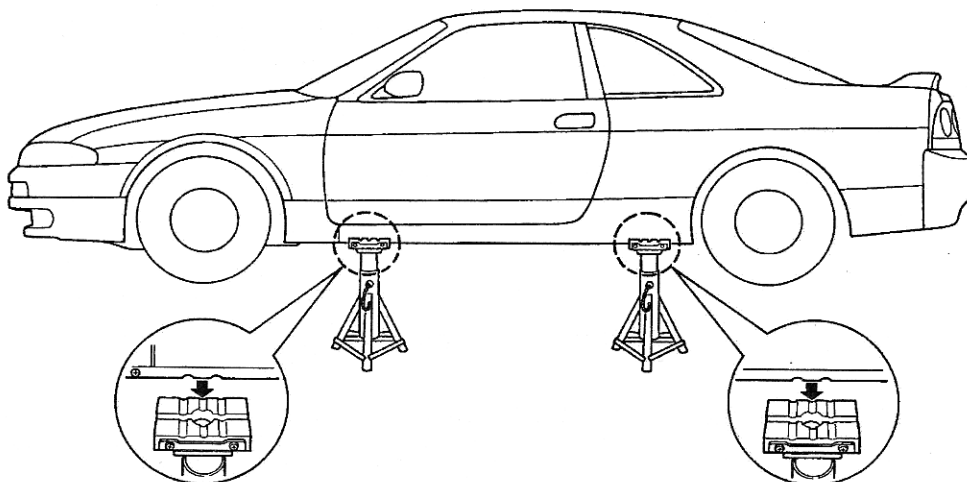
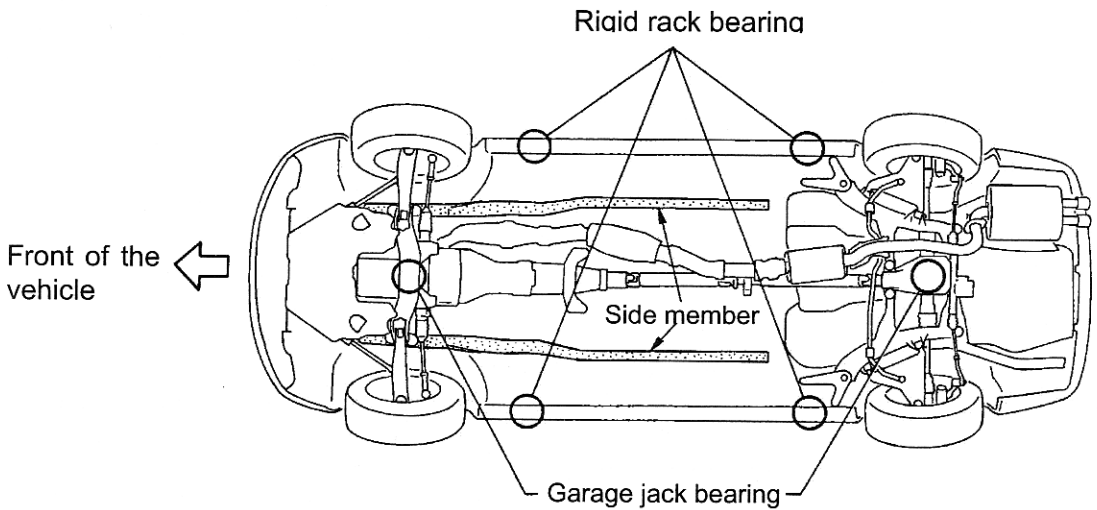

ABBREVIATION

A / C	Air conditioner
A / T	Automatic transmission
ABS	Anti-lock brake system
ACC	Accessory
ALT	Alternator
ASCD	Auto speed control device
ASSY	Assembly
AV	Audio visual
BAT	Battery
BC valve	Boost control valve
BPT valve	Back pressure transducer (Exhaust pressure control)
C / B	Circuit breaker
C / P	Crank pulley
C / U	Control unit
CD	Compact disc
Cyl	Cylinder
DOHC	Double overhead cam shaft
DSP	Digital signal processor
EGR	Exhaust gas circulation
ELR	Emergency locking retractor
ENG	Engine
EXH	Exhaust
F / L	Fusible link
FICD	First idle control device
FPCM	Fuel pump control module
GPS	Global positioning system
H / B	Hatch back
H / T	Hard top
HEC	Hybrid electronic control unit
I / P	Idler pulley
IAA	Idle auxiliary air unit
IAS	Idle adjust screw
IGN	Ignition
ILL	Illumination
INT	Intake
L.S.V	Load sensing valve
L / U	Lock up
LED	Light-emitting diode
LLC	Long life coolant
LSD	Limited slip differential
M / T	Manual transmission

NAVI	Navigation
O / D	Overdrive
OHC	Overhead cam shaft
OHV	Overhead valve
OS	Over size
P / S	Power steering
P / W	Power window
PBR	Potensio balance resistor
PTC	Potensio temp control
PTO	Power take off
S / V	Solenoid valve
SAS	Slow adjust screw
SRS	Supplemental restraint system
STD	Standard
TAS	Throttle adjust screw
TCS	Traction control system
TCU	Time control unit
Tr	Transistor
TV valve	Thermal vacuum valve
US	Under size
VENT	Ventilation
VTC	Calve timing control
VVT valve	Venturi vacuum transducer

MAIN UNITS CONVERSION

Type	SI unit	Meter unit	SI conversion
Acceleration	m/s ²	G	9.80665
Torque, moment	N-m	kgf-m	9.80665
Force	N	kgf	9.80665
Pressure	MPa	kgf/cm ²	0.0980665
	kPa	mmHg	0.133322
Power	kW	PS	0.735499
	W	kcal/h	1.16279
Volume	cm ³	cc	1
Spring constant	N/mm	kgf/mm	9.80665
Fuel consumption rate	* g/kW-h	g/ps-h	1.3596

* Meter unit that can be used in SI unit

4WD INSPECTION & REPAIR PRECAUTIONS

Follow the precautions below to measure the speedometer reading and to check braking performance in 4WD mode.

SPEEDOMETER MEASUREMENT

Two methods of measuring the speedometer are described below:

1. Measurement with front wheels jacked up

- Place the rear wheels on the roller.
- Jack up the vehicle front using the adapter and support with rigid rack.
- Place the transmission in 2nd gear for manual transmission vehicle and release the clutch slowly and increase the speed. For automatic vehicles place the shift lever in 2nd and increase the speed gradually.
- When the test is completed, do not apply the brakes suddenly.

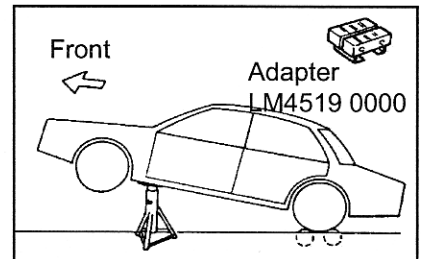

Caution:

Place the jack securely, and perform the measurement after making sure the vehicle is stable. Use the free rollers whenever possible.

2. Measurement using simple free roller

- Set the simple free roller the length of the wheel base (2720 mm) forward of the centre of the measurement roller as shown in the diagram.
- Place the front wheel on the free rollers and the rear wheels on the measurement rollers.
- Place in 2nd gear for manual transmission vehicles and gradually release the clutch. For automatic vehicles place the shift lever in 2nd and increase the speed gradually.
- When the test is completed, do not apply the brakes suddenly.

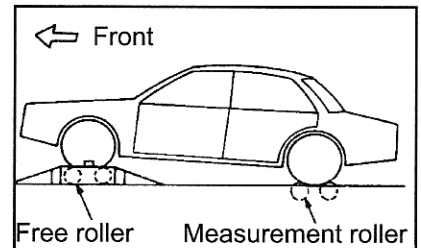
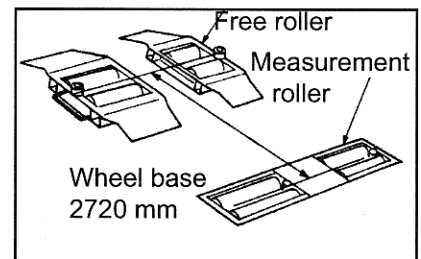

BRAKING PERFORMANCE CHECK

Measure using the low velocity type tester.

1. Front wheel braking inspection

- Place the front wheels on the tester.
- Place change lever to neutral position.
- Measure the brake performance of foot brake.

2. Rear wheel braking inspection

- Drive system must be set to 2WD mode.
- Place the rear wheels on the tester.
- Place change lever to neutral position.
- Measure the brake performance of hand brake and foot brake.

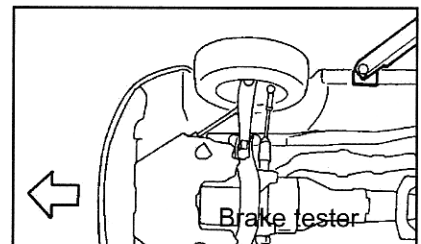

2WD setting

There are 2 methods to change the drive mode to 2WD setting:

1. Remove air evacuation connector, and depress the brake pedal 5 times within 10 seconds after placing the ignition switch to ON position. At the same time the 4WD warning lamp will flash in the meter panel (twice in a second) to indicate it is in 2WD mode. To return the vehicle drive mode to 4WD mode, place the ignition switch to OFF position and connect air evacuation connector.
2. Remove front propeller shaft.

Instrument panel lower right

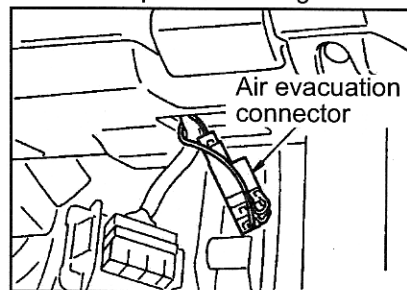
**4WD VEHICLE TOWING PRECAUTIONS****Towing precautions**

Never tow a 4WD vehicle for a distance over 30 km and do not exceed speed limit of 30 km / h.

Never tow a 4WD vehicle with front or rear wheels raised and opposite rear or front wheels on the ground as this may cause serious damage to the transaxle.

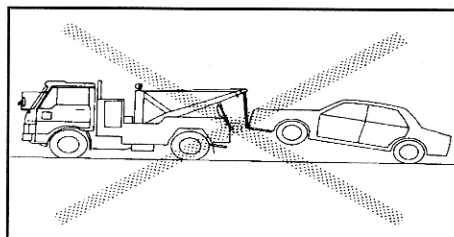
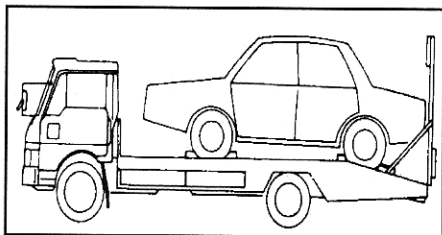

SECTION EN

ENGINE

CONTENTS

EN1	SPECIAL SERVICE TOOLS	EM-8
	SYSTEM DIAGRAM	EN-11
EN2	MAINTENANCE	
1.	Idle speed / Ignition timing / Idle mixture ratio inspection (RB20E / RB25DE / RB25DET / RB26DETT)	EN-15
2.	Compression pressure inspection (RB20E / RB25DE / RB25DET / RB26DETT)	EN-20
3.	Auxiliary belt tension (RB20E / RB25DE / RB25DET / RB26DETT)	EN-21
4.	Brake hose (RB20E / RB25DE / RB25DET / RB26DETT)	EN-23
5.	Brake fluid (RB20E / RB25DE / RB25DET / RB26DETT)	EN-25
6.	Master cylinder cap, wheel cylinder cap, disc calliper cap & dust seal (RB20E / RB25DE / RB25DET)	EN-26
	(RB26DETT)	EN-41
7.	Spark plug (RB25DE / RB25DET)	EN-43
	(RB26DETT)	EN-45
8.	Timing belt (RB20E)	EN-47
	(RB25DE / RB25DET)	EN-53
	(RB26DETT)	EN-58
9.	Engine oil (RB20E / RB25DE / RB25DET / RB26DETT)	EN-63
10.	Oil filter (RB20E / RB25DE / RB25DET / RB26DETT)	EN-64
11.	Coolant (RB20E / RB25DE / RB25DET / RB26DETT)	EN-65

EN3 ENGINE MECHANICAL**(RB20E ENGINE)**

1.	Air cleaner & air duct.....	EN-67
2.	Intake manifold collector	EN-68
3.	Fuel injector.....	EN-71
4.	Intake manifold.....	EN-73
5.	Exhaust manifold.....	EN-76
6.	Rocker cover	EN-78
7.	Rocker shaft	EN-79
8.	Cam shaft.....	EN-83
9.	Cylinder head gasket	EN-87
10.	Oil pan & oil filter	EN-90
11.	Collector ASSY.....	EN-92
12.	Oil pump.....	EN-94
13.	Cooling fan	EN-97
14.	Water pump.....	EN-98
15.	Thermostat & water inlet	EN-100
16.	Water outlet.....	EN-102

Refer to RB26DETT for the following:

•	Fuel tank	EN-240
•	Fuel pump & fuel gauge.....	EN-245

Refer to RB25DE / RB25DET for the following:

•	Exhaust system.....	EN-144
•	Dual mode muffler.....	EN-146

(RB25DE / RB25DET ENGINE)

1.	Air cleaner & air duct.....	EN-103
2.	Intake manifold collector	EN-105
3.	Fuel injector.....	EN-108
4.	Intake manifold.....	EN-111
5.	Exhaust manifold.....	EN-115
6.	Rocker cover	EN-118
7.	Oil pan & oil filter	EN-120
8.	Cam shaft.....	EN-122
9.	Cylinder head gasket	EN-128
10.	Oil pump.....	EN-131
11.	Radiator.....	EN-134
12.	Cooling fan	EN-136
13.	Auxiliary motor fan	EN-137
14.	Water pump.....	EN-138

15. Thermostat & water inlet	EN-140
16. Accelerator control system	EN-142
17. Exhaust system	EN-144
18. Dual mode muffler	EN-146

Refer to RB26DETT for the following:

• Fuel tank	EN-240
• Fuel pump & fuel gauge	EN-245

(RB25DET ENGINE)

1. Inter-cooler	EN-148
2. Turbo-charger	EN-150
3. Oil filter bracket & oil cooler	EN-156

(RB26DETT ENGINE)

1. Air cleaner & air duct	EN-158
2. Inter-cooler	EN-160
3. Fuel injector	EN-164
4. Intake manifold collector	EN-166
5. Intake manifold	EN-174
6. Turbo-charger & Exhaust manifold	EN-178
7. Rocker cover	EN-188
8. Oil pan & oil filter	EN-190
9. Cam shaft	EN-193
10. Valve clearance	EN-198
11. Cylinder head gasket	EN-200
12. Cylinder head	EN-203
13. Cylinder block	EN-209
14. Oil pump	EN-226
15. Oil filter bracket & water-cooled oil cooler	EN-228
16. Air-cooled oil cooler (N1 vehicle)	EN-231
17. Radiator	EN-233
18. Cooling fan	EN-235
19. Auxiliary motor fan	EN-236
20. Water pump	EN-237
21. Accel control system	EN-239
22. Fuel tank	EN-240
23. Fuel pump & fuel gauge	EN-245
24. Exhaust system	EN-248

EN4 ENGINE REMOVAL

(RB20E)	EN-250
(RB25DE / RB25DET)	EN-254
(RB26DETT)	EN-259

EN5 SYSTEM OUTLINE

Circuit diagram & ECCS control unit pin layout

(RB20E)	EN-263
(RB25DE / RB25DET)	EN-265
(RB26DETT)	EN-267

EN6 ECCS (ELECTRONICALLY CONCENTRATED ENGINE CONTROL SYSTEM)

1. For accurate & quick diagnosis	EN-269
2. Diagnosis items by phenomenon	EN-275
3. Diagnostic system	EN-294
4. Self-diagnosis	EN-296
5. Consult	EN-301
6. Basic inspection	
(RB20E / RB26DETT)	EN-307
(RB25DE / RB25DET)	EN-309

**EN7 FAULT DIAGNOSIS BY SELF-DIAGNOSIS SYSTEM
(RB25DE / RB25DET ENGINE)**

1. Power supply and earth circuit	EN-312
2. Crank angle sensor system (Self-diagnosis display 11)	EN-314
3. Air flow meter system (Self-diagnosis display 12)	EN-316
4. Water temperature sensor system (Self-diagnosis display 13)	EN-318
5. Ignition system (Self-diagnosis display 21)	EN-319
6. O2 sensor system (Self-diagnosis display 15)	EN-321
7. Detonation sensor system (Self-diagnosis display 34)	EN-322
8. Throttle sensor system (Self-diagnosis display 43)	EN-323
9. A / T control system (Self-diagnosis display 54)	EN-324
10. Crank angle sensor system (Not in self-diagnosis)	EN-325

(RB26DETT ENGINE)

1. Power supply and earth circuit	EN-326
2. Crank angle sensor system (Self-diagnosis display 11)	EN-328
3. Air flow meter system (Self-diagnosis display 12)	EN-330

4.	Water temperature sensor system (Self-diagnosis display 13).....	EN-332
5.	Ignition system (Self-diagnosis display 21)	EN-334
6.	Detonation sensor system (Self-diagnosis display 34)	EN-336
7.	Intake air temperature sensor system (Self-diagnosis display 41)...	EN-338
8.	Throttle sensor system (Self-diagnosis display 43).....	EN-340
9.	O2 sensor system	EN-342
10.	Component parts inspection	
	1. Crank angle sensor	EN-334
	2. Air flow meter	EN-334
	3. Water temperature sensor	EN-334
	4. Power transistor	EN-345
	5. Intake air temperature sensor	EN-345
	6. Throttle sensor	EN-345
	7. ECCS relay	EN-345

EN8 SYSTEM FAULT DIAGNOSIS (RB25DE / RB25DET ENGINE)

1.	Fuel pump system control	EN-346
2.	Ignition signal - 1	EN-348
3.	Ignition signal - 2	EN-350
4.	Injector system inspection	EN-351
5.	Vehicle speed sensor system.....	EN-353
6.	Air conditioner relay system	EN-354
7.	Exhaust gas sensor heater system	EN-355
8.	Throttle valve switch system	EN-356
9.	START signal	EN-358
10.	AAC valve system	EN-389
11.	Air regulator.....	EN-360
12.	Power steering oil pressure signal	EN-362
13.	Components parts inspection	
	1. Crank angle sensor	EN-363
	2. Air flow meter	EN-363
	3. Water temperature sensor.....	EN-363
	4. Ignition coil	EN-364
	5. Power transistor	EN-364
	6. Fuel pump	EN-364
	7. Throttle valve switch.....	EN-364
	8. Throttle sensor	EN-365
	9. AAC valve.....	EN-365
	10. FICD solenoid	EN-365
	11. Air regulator	EN-366

12. Injector	EN-366
13. Ignition relay & Inhibitor relay.....	EN-366
14. Power steering hydraulic pressure inspection.....	EN-366

(RB26DETT ENGINE)

1. Fuel pump system inspection.....	EN-367
2. Injector system inspection.....	EN-370
3. Ignition system inspection.....	EN-373
4. AAC valve system	EN-376
5. Injector pulse.....	EN-378
6. Boost control	EN-379
7. Air conditioner cut control.....	EN-381
8. Throttle valve switch system	EN-382
9. O2 sensor heater system	EN-384
10. Vehicle speed sensor system.....	EN-385
11. Ignition switch (START) signal	EN-386
12. Power steering oil pressure signal	EN-387
13. Neutral signal	EN-388
14. Air conditioner operation signal.....	EN-389
15. Air regulator signal	EN-390
16. Supplemental motor fan control	EN-392
17. Component parts inspection	
1. Ignition coil	EN-394
2. Ignition coil relay	EN-394
3. Throttle valve switch.....	EN-394
4. Injector	EN-395
5. Dropping resistor.....	EN-395
6. Fuel pump	EN-395
7. Fuel pump control modulator	EN-395
8. O2 sensor heater	EN-395
9. Air regulator.....	EN-396
10. AAC valve.....	EN-396
11. Boost control solenoid.....	EN-396
12. Supplementary power fan motor	EN-396
13. Power steering oil pressure switch.....	EN-397
14. Supplementary motor fan relay & fuel pump relay	EN-397
15. Water temperature switch	EN-397





**EN9 SYSTEM DIAGNOSIS INSPECTION
(RB20E ENGINE)**

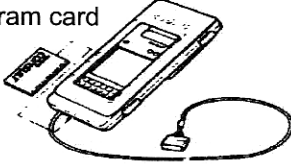

1. Fuel pump system	EN-398
2. Injector system	EN-401
3. Ignition system	EN-404
4. Idle speed control system	EN-408
5. Crank angle sensor system.....	EN-410
6. Air flow meter sensor system	EN-413
7. Throttle valve switch system	EN-416
8. Throttle sensor system.....	EN-419
9. Engine temperature sensor system	EN-422
10. O2 sensor heater system	EN-424
11. Detonation sensor system.....	EN-426
12. Vehicle speed sensor system.....	EN-427

EN10 ECCS CONTROL UNIT INPUT / OUTPUT SIGNAL

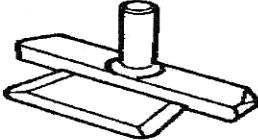
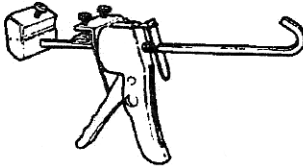
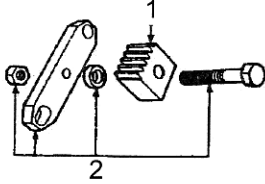
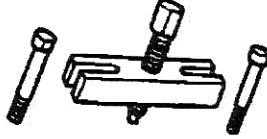
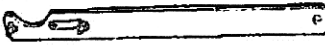
(RB26DETT)	EN-428
(RB20E)	EN-436
(RB25DE / RB25DET).....	EN-444

EN 1 SPECIAL SERVICE TOOLS

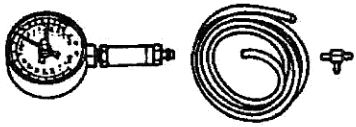
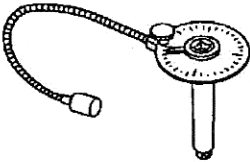
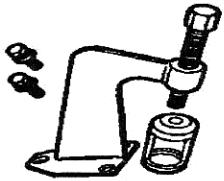
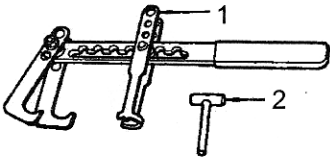
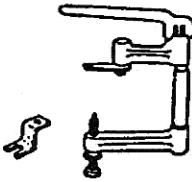
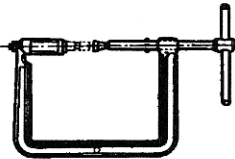
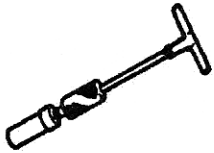
TOOLS		USE
<p>Spark plug wrench EG1740 1600</p>		<p>Removal & installation of spark plug</p>
<p>Electronic system diagnosis tester CONSULT EG1180 0000</p>	<p>Program card</p> 	<p>Fuel pressure removal Engine rev adjustment</p>
<p>Vacuum handy pump EG1513 0000</p>		<p>Recirculation valve inspection (RB25DE)</p>
<p>Seat cutter KV101 11100</p>		<p>Oil pan removal</p>
<p>Tube pressor WS3993</p>		<p>Liquid gasket lubrication</p>
<p>Ring gear stopper KV101 104S0 1. Adapter KV101 10410 2. Stopper plate KV101 05610</p>		<p>Fly-wheel, drive plate installation</p>
<p>Pulley puller KV111 03000</p>		<p>Crank pulley removal</p>
<p>Pulley holder KV101 09900</p>		<p>Cam timing pulley removal & installation (RB20E)</p>
<p>Pulley holder KV101 09300</p>		<p>Cam timing pulley removal & installation (RB20E)</p>

TOOLS		USE
Compound gauge EG1508 0001		Turbo charger pressure inspection (RB25DET)
Pressure gauge (For LPG vaporizer inspection) ST1957 2000		Turbocharger swing valve controller inspection (B25DET)
Angle wrench KV101 12100		Installation angle check
Valve spring compressor KV101 10601		Valve collet installation & removal (RB20E)
1. Valve spring compressor KV101 09210 2. Adapter KV101 11200		Valve collet installation & removal (RB20E)
Valve sprint compressor ST1207 0000		Valve collet installation & removal (RB20E)
Valve spring compressor KV101 089S0		Valve collet installation & removal (RB25DE / DET)
Valve oil seal puller KV101 07900		Valve oil seal removal
Valve guide drift KV101 11000 (intake) ST1103 3000 (exhaust)		Valve guide installation & removal (RB20E)
Valve guide drift KV101 11800		Valve guide installation & removal (RB25DE / DET)

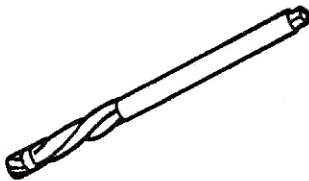
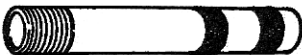
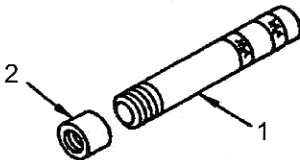
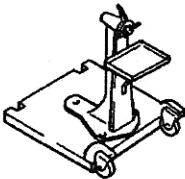
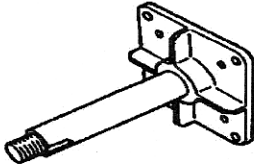
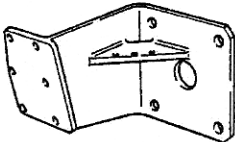
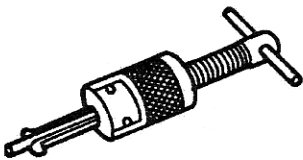
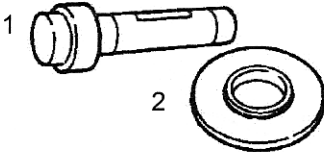
TOOLS		USE
Valve guide reamer (Intake) KV101 07700 (Φ11.2) KV101 08400 (Φ7.0) (Exhaust) ST1103 2000 (Φ12.0) ST1108 1000 (Φ8.0)		Valve guide installation (RB20E)
Valve guide reamer set HT5628 (Φ9.5 ~ Φ12) HT5627 (Φ6.35 ~ Φ9.5)		Valve guide installation (RB25DE / RB25DET)
Valve oil seal drift KV101 07501		Valve oil seal installation (RB20E)
Valve oil seal drift 1. Body KV101 07501 2. Attachment KV101 11400		Valve oil seal installation (RB25DE / RB25DET)
Engine stand ASSY ST0501 S000		Engine overhaul
Engine attachment KV101 06500		
Engine sub attachment KV101 14500		Engine overhaul
Pilot bearing puller ST1661 0001		Pilot converter, pilot bush removal
Rear oil seal drift 1. KV401 00900 2. ST3002 2000		Rear oil seal installation

RB20 - EGI ENGINE

SYSTEM DIAGRAM
RB20E ENGINE

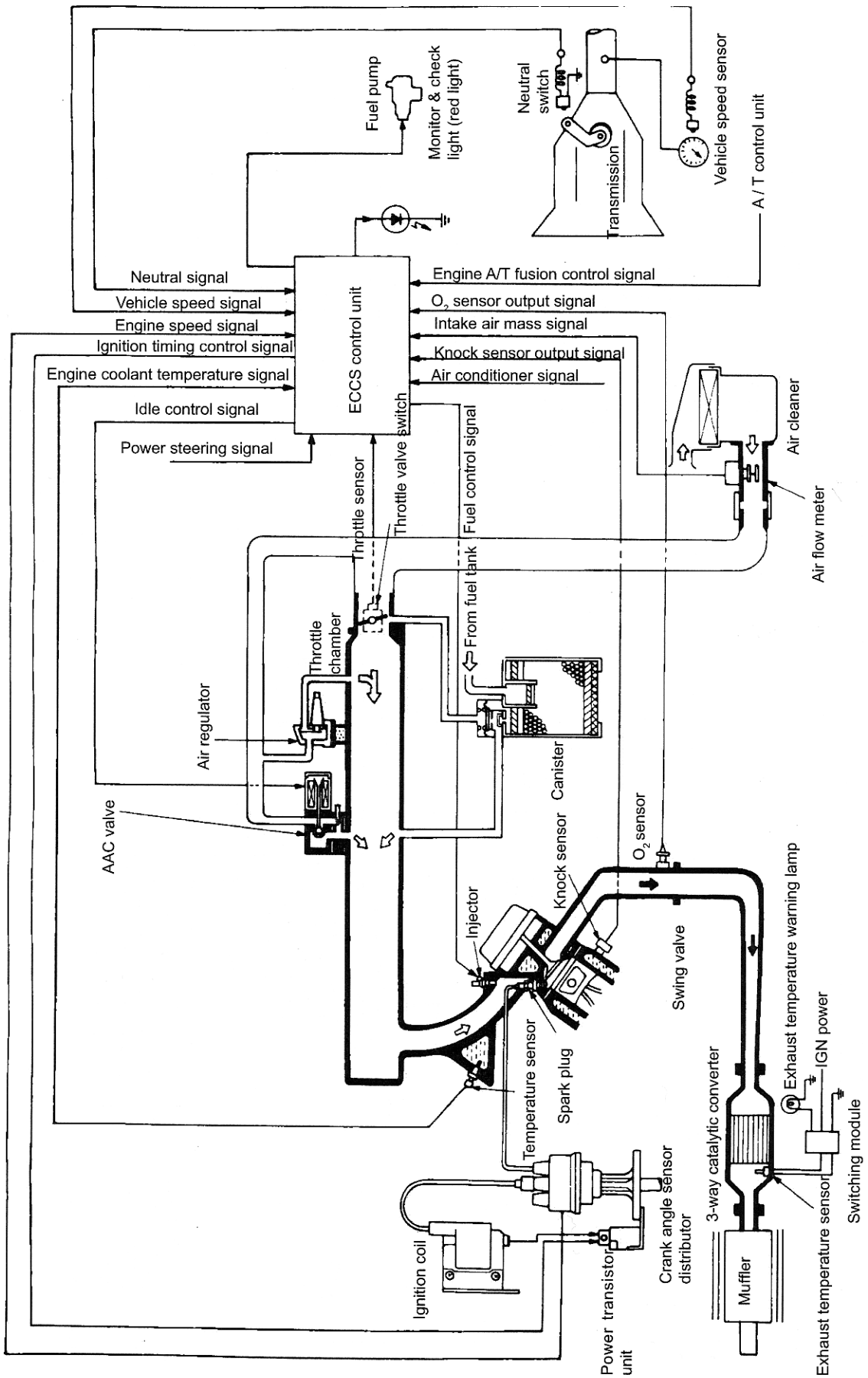

RB25DE ENGINE

SYSTEM DIAGRAM
RB25DE ENGINE

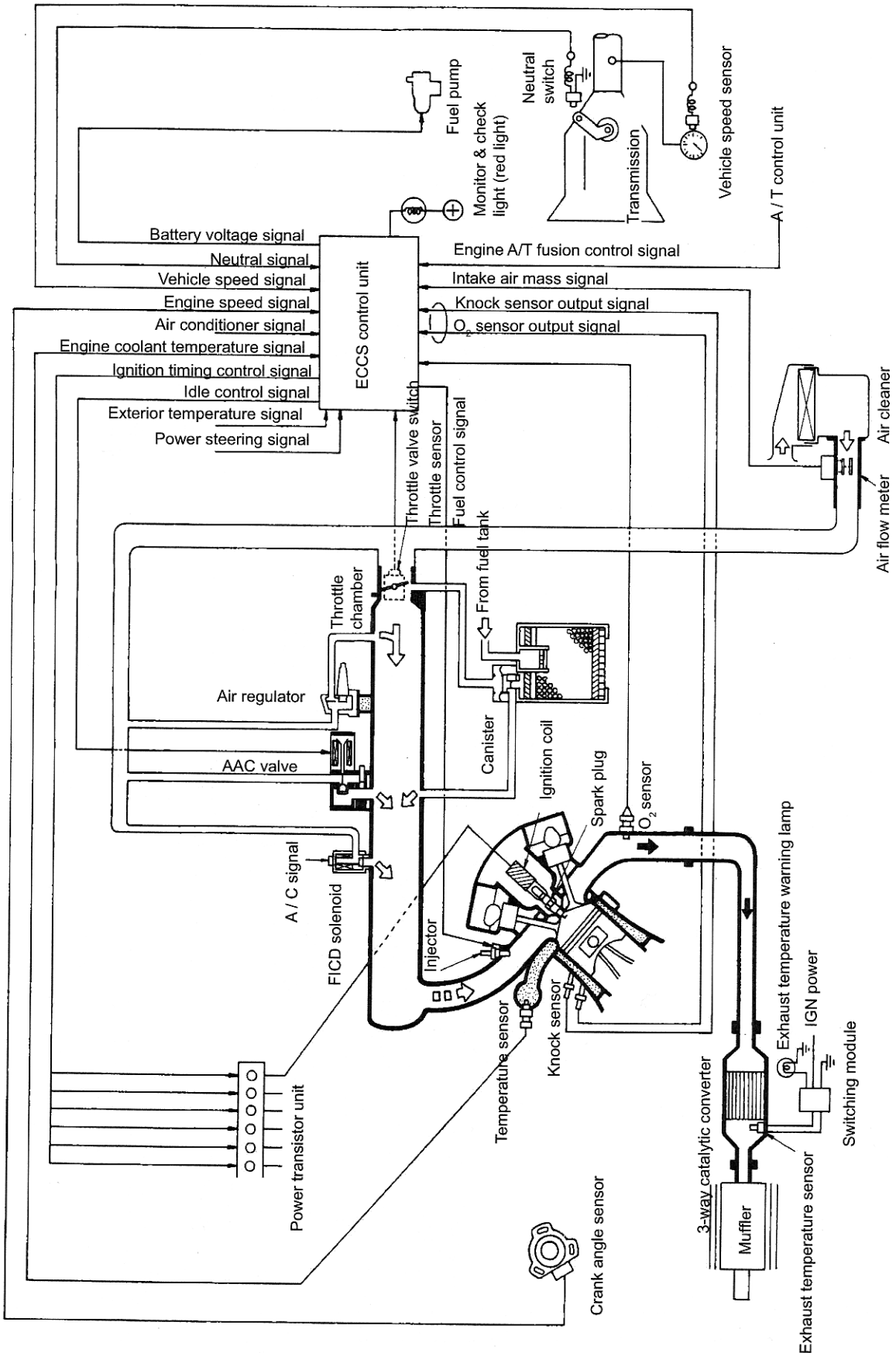

RB26DETT DOHC - EGI (ECCS) TWIN-TURBOCHARGER ENGINE

SYSTEM DIAGRAM

RB26DETT DOHC - EGI (ECCS) TWIN-TURBOCHARGER ENGINE

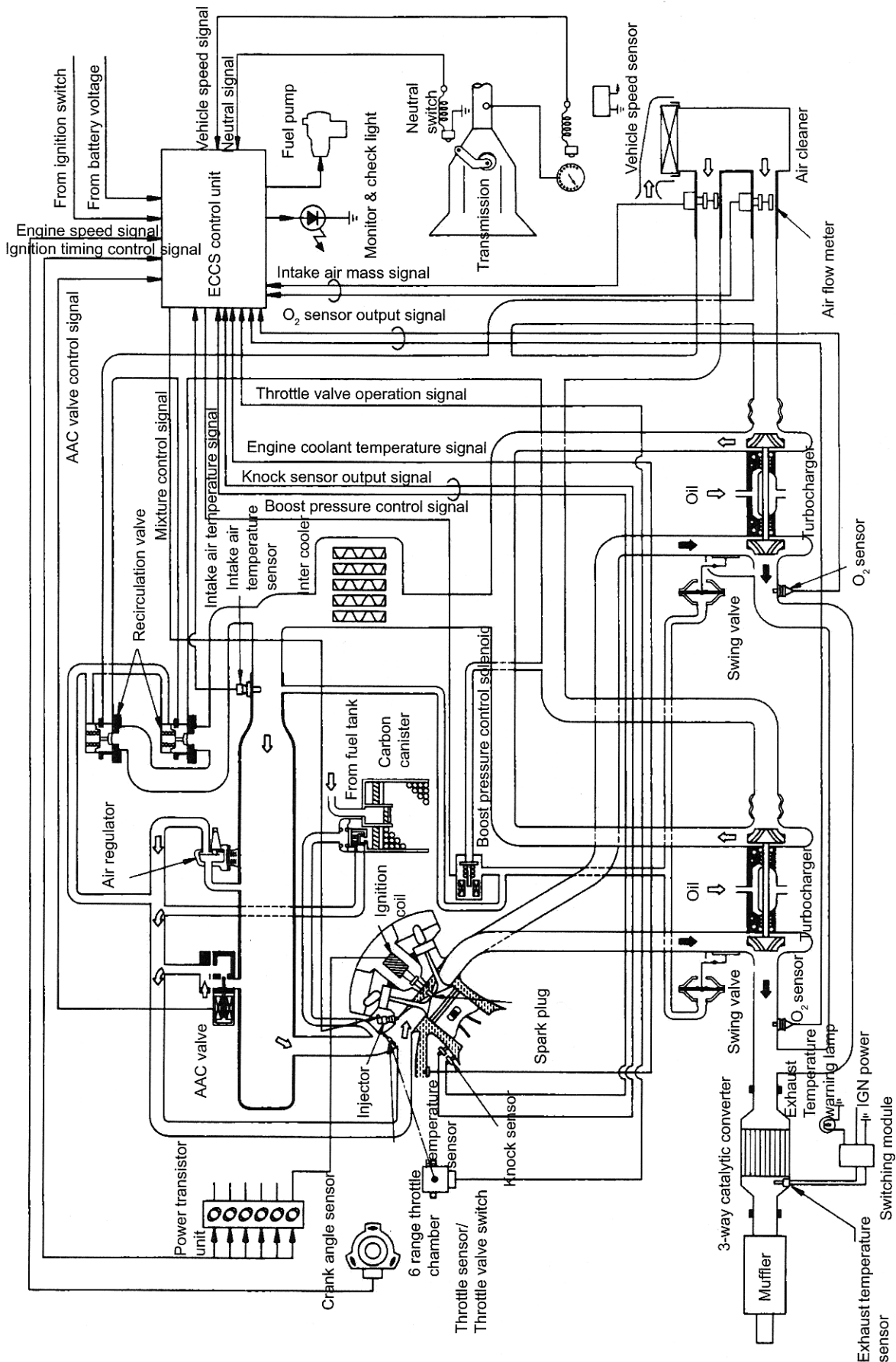

RB25DET ENGINE

SYSTEM DIAGRAM
RB25DET ENGINE

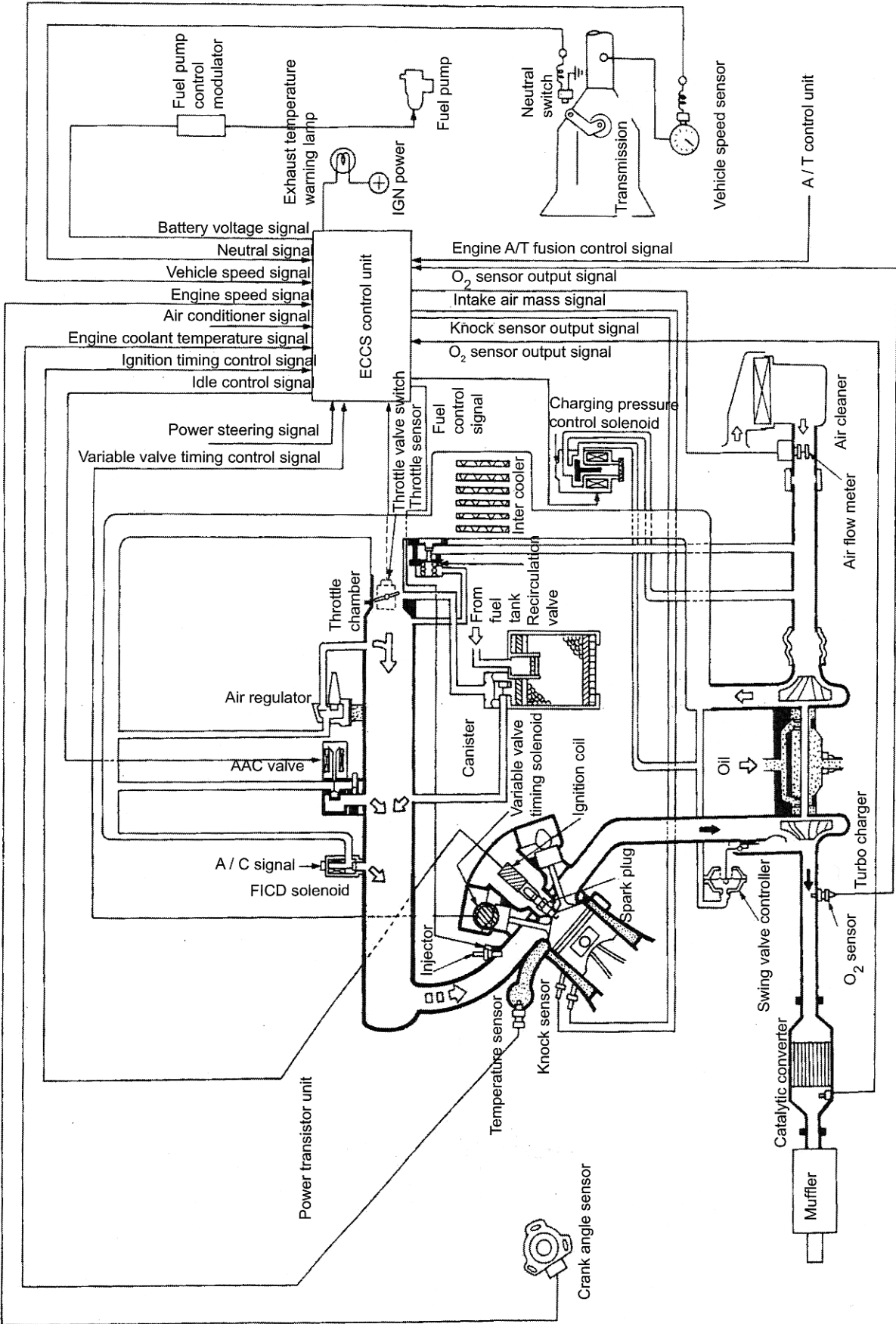

EN2 MAINTENANCE

1. IDLE SPEED / IGNITION TIMING / IDLE MIXTURE RATIO INSPECTION

ENGINE	Idle speed (rpm) (when A / C is ON)	Ignition timing (BTDC° / rpm)	CO / HC density (%) / (ppm)
RB20E	A / T 650 M / T 600 (Approx. 800 rpm)	A / T 20 +/- 2/600 +/- 50 M / T 20 +/- 2/600 +/- 50	Below 0.1 / below 50
RB25DE	650 (Approx. 800 rpm)	15 +/- 2/650 +/- 50	
RB25DET	650 (Approx. 800 rpm)	15 +/- 2/650 +/- 50	
RB26DETT	950 +/- 50	21 +/- 1/950 +/- 50	

IDLE INSPECTION & ADJUSTMENT

Engine speed measurement unit

- Warm the engine sufficiently. 
- Connect CONSULT to diagnosis connector on the vehicle (near the fuse block). Place the ignition switch to ON position.

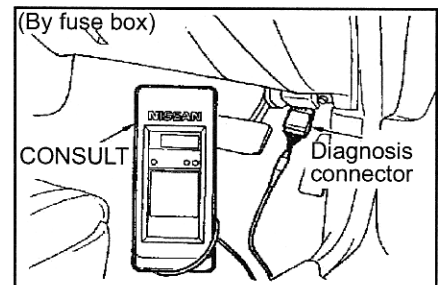

(RB20E)

- Connect the measurement unit to the speed detection terminal by connecting the adapter harness for the mould coil between the coil primary terminal and the primary terminal harness connector. 

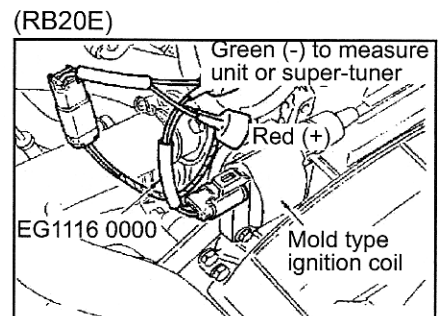

(RB25DE / RB25DET / RB26DETT)

- Connect the measurement unit to the speed detection terminal harness connected to the ignition coil from the power transistor. 
- When the measurement is complete, always replace the terminal cap on the detection terminals.

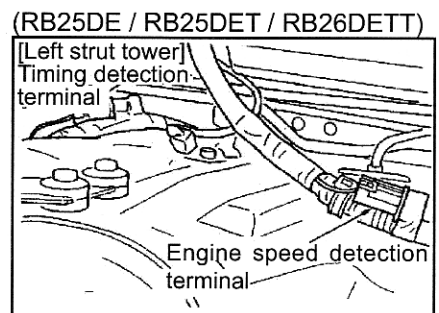

Caution:

Check the specification for the measurement unit before using the unit as the generation voltage is set to 6V.



Inspection

- Make sure the A / C load , power steering oil pump load and each electrical loads are not applied. Place the select lever in 'N' position for automatic vehicles.

Caution:

Before inspection when the accelerator pedal is not depressed, make sure the throttle valve switch (idle connection point) is turned to ON.

RB20E / RB25DE / RB25DET / RB26DETT ENGINE

- Check "CAS.RPM (REF)" for RB20E and, "CAS.RPM (POS)" for RB25DE / RB25DET / RB26DETT engines. 
- Carry out the inspection using the engine speed measurement unit. 

☆MONITORING☆ NO FAULT	
CAS.RPM (POS)	662rpm
AIR FLOW MTR	1.12V
ENG COOLANT TEMP SEN	83°C
O2 SEN	0.37V
O2 SEN MONITOR	LEAN
VEHICLE SPEED SEN	0km/h
BATTERY VOL	14.0V
THROTTLE SEN	0.40V
RECORD	

Adjustment

Idle adjustment is basically not necessary as the rated value (control target value) is returned to the control unit. If adjustment becomes necessary, carry out the procedure below.

- Select "AAC valve adjustment" in "Work support" mode. Adjust the engine rev to set value by turning idle adjustment screw in IAA unit using a screw driver. 

◆ AAC VALVE ADJ ◆	
Adjustment monitor	
CAS.RPM (POS)	612rpm
Condition setting	
AAC valve	Guide fixed
Monitor	
ENG TEMP SEN	83°C
IDLE SW	ON

Engine rev set value (rpm)

RB20E (M / T)	600
RB20E (A / T) / RB25DE / RB25DET	650
RB26DETT	900

- Return "AAC valve adjustment" screen to "DATA monitor" and check if the idle speed displayed meets the specification.
- Make sure the ECCS C/U idle control adjustment volume is turned to left completely. 

Caution:

Do not turn the idle control adjustment volume with excessive force. The adjustment screw turning range is 3/4 of a turn.

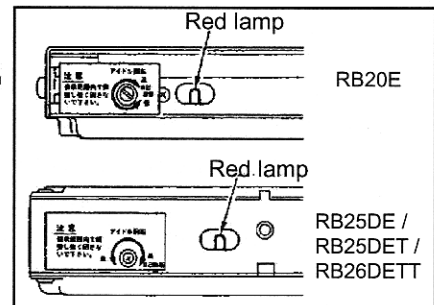

(RB20E / RB25DE / RB25DET)

(RB20E / RB25DE / RB25DET)

- Remove throttle sensor harness connector to stop idle rev feed back control (at this time, AAC valve will fix at idle set opening).

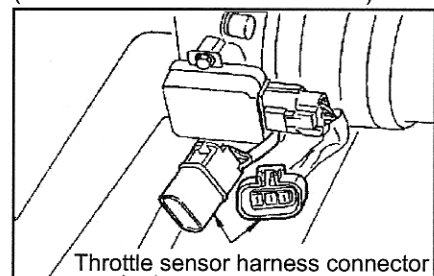

(RB26DETT)

(RB26DETT)

- Remove AAC valve harness connector to stop idle rev feed back control (at this time, AAC valve will fix at idle set opening).

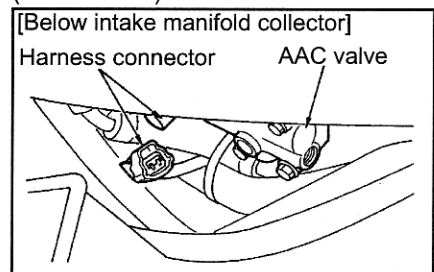

RB20E / RB25DE / RB25DET / RB26DETT ENGINE

- Turn the IAA unit idle adjustment screw using a screw driver to adjust the engine rev.

Engine rev set value (rpm)

RB20E (M / T)	600
RB20E (A / T) / RB25DE / RB25DET	650
RB26DETT	900

- Engine rev will increase when the idle adjust screw is turned anticlockwise and decrease when it is turned clockwise.

(RB20E / RB25DE / RB25DET)

- Reconnect the throttle sensor harness connector and make sure the idle speed is maintained at specified value.

(RB26DETT)

- Reconnect the AAC valve harness connector and make sure the idle speed is maintained at specified value.

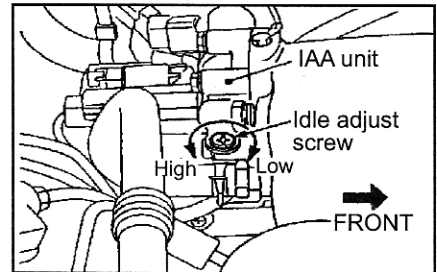

- If you wish to increase idle speed for any reason, adjust the idle control adjustment volume in ECCS control unit. Turn it clockwise to increase the engine rev. Maximum volume is approx. 250 rpm.

Caution:

The adjustment volume must be set at 40° ~ 50° away from the self-diagnosis position as if it is turned all the way to the right (self-diagnosis position), the idle speed is lowered (lowest rpm +50).

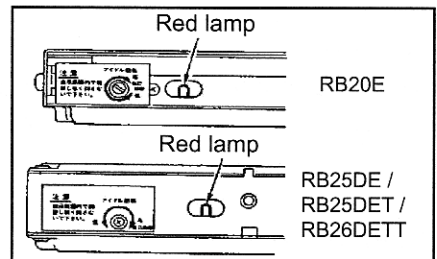

IGNITION TIMING INSPECTION & ADJUSTMENT

Timing light attachment

(RB20E)

- Connect the timing light using the mold coil adaptor harness. The timing light collects the signal from the primary terminal of super-tuner. (For normal timing light, connect the sensor to the No.1 high-tension cable).

(RB20E)

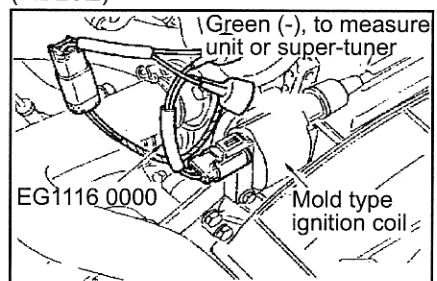

(RB25DE / RB25DET / RB26DETT)

When using super-tuner

- Connect the super-tuner to the timing detection terminal.

Caution:

After inspection make sure to place a hole cap on the timing detection terminal (check connector).

(RB25DE / RB25DET / RB26DETT)

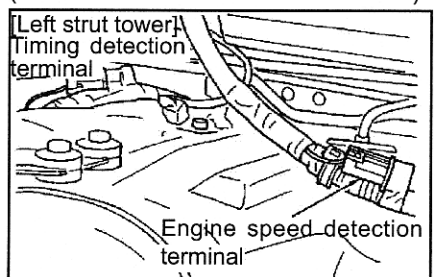

RB20E / RB25DE / RB25DET / RB26DETT ENGINE

When using a primary electrical detection timing light

- Connect sensor to No. 1 cylinder primary ray when using EG1443 0001 or EG1444 0000 (No. 1 cylinder primary ray is longer than other cylinders).

Caution:

When using EG1444 0000 (Built-in battery type), face the sensor (direction of the arrow) to spark plug when connecting the sensor to the primary ray.

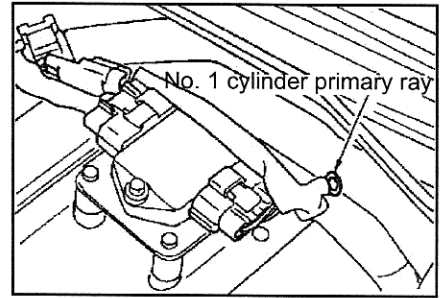

Inspection

- Make sure the idle speed is at standard value.
- Check that ignition timing is at standard value when idling.

RB20E (A / T)	20° +/- 2° / 650 +/- 50rpm
RB20E (M / T)	20° +/- 2° / 600 +/- 50rpm
RB25DE / RB25DET	15° +/- 1° / 650 +/- 50rpm
RB26DETT	20° +/- 1° / 950 +/- 50rpm
- Make sure the ignition timing advances to correct angle when engine is raced.

Caution:

0° timing mark on the crank pulley is indicated in orange and other points are painted in white.

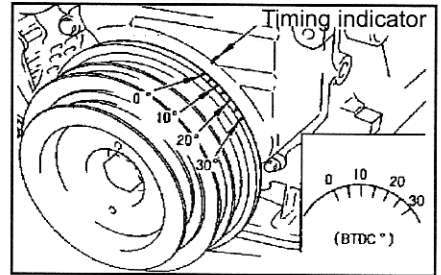

Adjustment

(RB20E)

- Ignition timing can be adjusted by adjusting the distributor installation position.
- Make sure the idle speed is at standard value.
- Remove throttle sensor connector.
- Loosen the distributor installation bolt and rotate the distributor. Turn the distributor clockwise to advance ignition timing.
- Connect the throttle sensor connector.
- After checking the idle rev and making sure it is at set value, seal the distributor installation bolts with sealing tape.

Sealing tape part No. B2235 U7410

(RB20E)

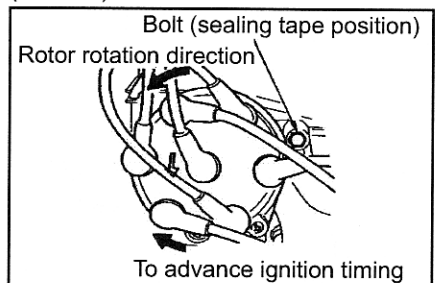

(RB25DE / RB25DET / RB26DETT)

The ignition timing adjustment is basically not necessary as the ignition timing will not change over time. If adjustment becomes necessary, carry out the adjustment when installing the crank angle sensor.

- Adjust the ignition timing by adjusting the crank angle sensor installation position.
- Make sure the idle speed is at standard value.
- Remove throttle sensor connector.

(RB25DE / RB25DET / RB26DETT)

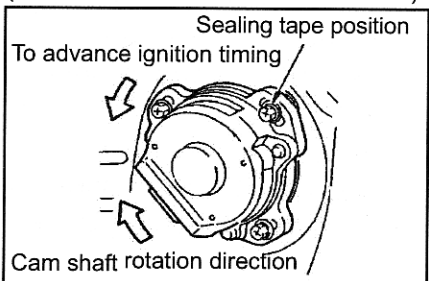

RB20E / RB25DE / RB25DET / RB26DETT ENGINE

- Loosen 3 crank angle sensor installation bolts and rotate the crank angle sensor. Turn the sensor anti-clockwise to advance ignition timing.
- Connect the throttle sensor connector.
- After checking the idle rev and making sure it is at set value, tighten the bolts and seal one of the crank angle sensor installation bolt with sealing tape.
Sealing tape part No. B2235 U7410

IDLE MIXTURE RATIO

The air-fuel ratio feedback system has a self-learning function. CO and HC density adjustment is not necessary as correction range is extensive.

Inspection

- Warm up the engine sufficiently and make sure the idle speed and the ignition timing are at standard value. Check CO and HC density with CO and HC meter.
- If the values do not conform to standard value, perform following procedures to inspect air-fuel feedback condition:

- In the "DATA MONITOR" mode, select "O₂ sensor monitor". 
- Increase the engine rev to above 2000rpm and make sure "RICH" and "LEAN" are displayed alternatively.

☆MONITORING☆	NO FAULT	<input type="checkbox"/>
CAS.RPM (POS)	2000rpm	
AIR FLOW MTR	1.61V	
ENG COOLANT TEMP SEN	80°C	
O ₂ SENSOR	0.52V	
O ₂ SENSOR MONITOR	RICH	
VEHICLE SPEED SEN	0km/h	
BATTERY VOL	14.0V	
THROTTLE SEN	0.54V	

RECORD

- Short-circuit the self-diagnosis connector on the vehicle side (within fuse block). OR remove the ECCS control unit and operate the adjustment volume on the control unit side. 

- Place the ignition switch to the ON position and use a lead line to short-circuit the CHK and IGN pin of the diagnosis connector for more than two seconds to release the setting. OR Place the ignition switch to ON position and turn the adjustment volume on ECCS control unit side clockwise (self-diagnosis position) for more than two seconds and then return to normal position.

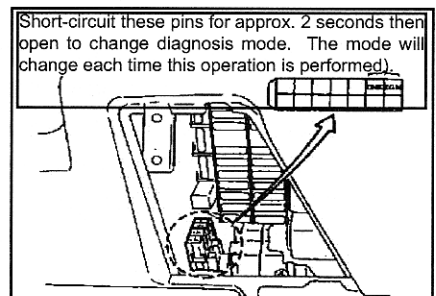

- After warming up the engine sufficiently, raise the engine speed until the engine warning lamp (or ECCS control unit side red lamp) flashes (the flashing will usually start above approx. 2000rpm).

Caution:

The accelerator pedal must be pressed lightly during idling to perform the inspection as the air-fuel ratio feed back control is clamped.

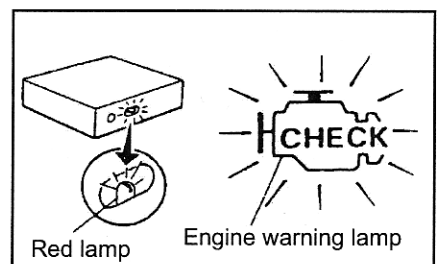

2. COMPRESSION PRESSURE INSPECTION

ENGINE	Standard value (MPa/rpm){kg/cm ² /rpm}	Limit value (MPa/rpm){kg/cm ² /rpm}	Variance limit between cylinders (MPa/rpm){kg/cm ² /rpm}
RB20E	1.23/300 {12.5/300}	0.93/300 {9.5/300}	0.10/300 {1.0/300}
RB25DE	1.26/300 {12.8/300}	0.96/300 {9.8/300}	0.10/300 {1.0/300}
RB25DET	1.20/300 {12.2/300}	0.90/300 {9.2/300}	0.10/300 {1.0/300}
RB26DETT	1.18/300 {12.0/300}	0.88/300 {9.0/300}	0.10/300 {1.0/300}

1. Warm up the engine sufficiently.
2. Release the fuel pressure.
3. Place the ignition switch to OFF position.
4. Remove all six spark plugs using the spark plug wrench.

Note:

When removing the spark plugs make sure to blow around the spark plug with compressed air.

5. Install engine rev counter or CONSULT.
 6. Remove injection harness connector.
 7. Install adapter to allen compression gauge and then set to engine.
 8. Depress the accelerator pedal fully. Place the ignition switch to START position and crank the engine. Read compression pressure and engine speed once the gauge needle stop moving. Carry out the above operation for each cylinder.
- When the engine speed is out of specification, check the specific gravity of the battery and perform test again.
 - If the compression pressure is still not in standard value, inspect the components around the combustion chamber (valve, valve seat, hydraulic valve lifter, piston, piston ring, cylinder bore, cylinder head, cylinder head gasket etc.). Correct any malfunction parts and repeat compression test.

(RB20E)

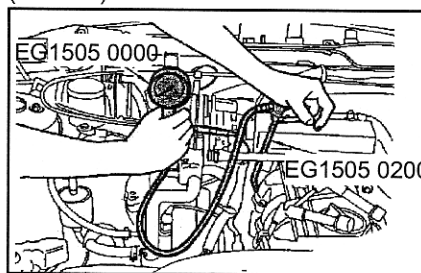

(RB25DE / RB25DET)

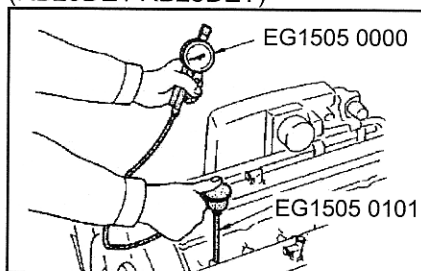

(RB26DETT)

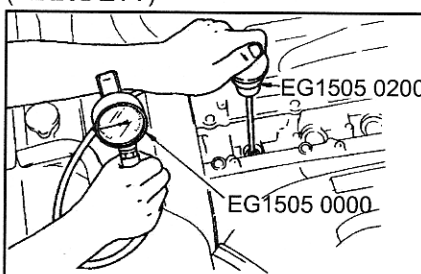

3. AUXILIARY BELT TENSION

Parts	Belt used	Tension (N{kg})			Belt deflection (mm) (98N{10kg} of force is applied)		
		New belt	Adjustment	Re-tension limit	New belt	Adjustment	Re-tension limit
Power steering belt	Poly-V low maintenance belt	490 ~ 578 {50 ~ 59}	382 ~ 470 {39 ~ 48}	225 {23}	8 ~ 10	9 ~ 11	15
A / C compressor belt	Poly-V low maintenance belt	666 ~ 755 {68 ~ 77}	558 ~ 647 {57 ~ 66}	284 {29}	6 ~ 8	7 ~ 9	12
Fan belt	Poly-V low maintenance belt	666 ~ 775 {68 ~ 77}	558 ~ 647 {57 ~ 66}	284 {29}	3 ~ 5	4 ~ 6	7.5

Inspection

- The inspection should be performed when the engine is cold or more than thirty minutes after the engine has been stopped.
- When carrying out the inspection, apply pressure 98N{10kg} to “▼” position shown in the diagram.
- When carrying out the inspection using the tension meter set it to “▼” position shown.
- The operation can be done at different positions when it is difficult to carry out the inspection at “▼” position.

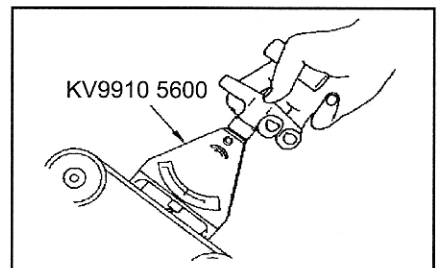
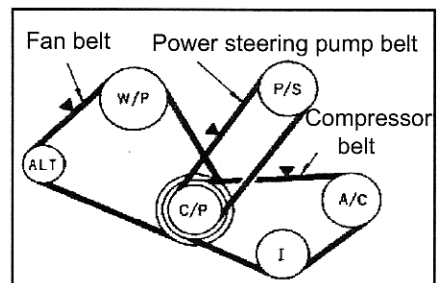

Adjustment

Parts	How to adjust
Power steering belt	Adjustment bolt on the power steering pump
A / C compressor belt	Adjustment bolt on the idler pulley
Fan belt	Adjustment bolt on the alternator

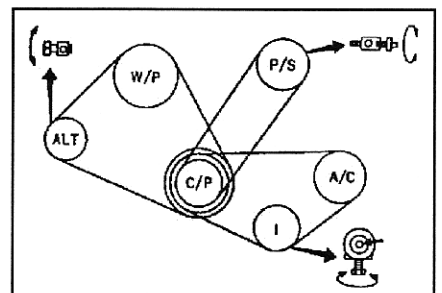

Caution:

- When replacing the belt with new ones, increase the tension slightly more than used belt to allow for wear-in of the new belt.
- When adjusting the belts, if the belt deflection exceeds the limit, adjust to the 'Adjustment value'.
- Make sure the pulley groove is aligned correctly when the belt is installed.
- Make sure there is no grease or water adhered to belts.
- Do not bend or twist belts unnecessarily.

Removal

1. Remove the power steering pump by loosening the power steering bolt.
2. Remove the compressor belt by loosening the bolt located by idler pulley.
3. Remove the fan belt by loosening the adjustment bolt located by alternator.
4. Shift power steering pump to remove the power steering pump belt.

Installation

Carry out the operation in reverse order to install.

4. BRAKE HOSE

Caution:

Make sure there are no twist or fold when installing the brake hose.

- There are no friction between parts when the steering wheel is turned fully right or left.
- If brake fluid leak is detected disassemble the parts and replace with new one if there is any fault.

Replacement period: Every 4 years

Removal

1. Connect vinyl tube to air breather.
2. Depress the brake pedal to discharge brake fluid from each air breather.
3. Place a cover so the dust or foreign objects will not enter brake fluid line connection parts.

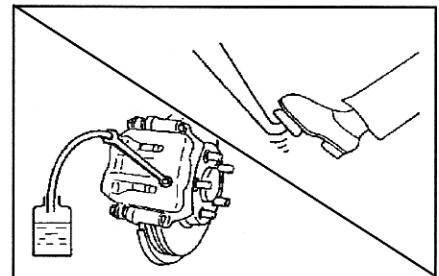

4. Carry out the procedures below to remove the brake hose:

[Vehicle with CL25VA & CL25VD type calliper]

- (1) Disconnect the brake hose and the brake tube by removing the flare nut on the brake tube using the flare nut wrench.
- (2) Remove the union bolt to detach calliper ASSY and brake hose.
- (3) Remove lock plate.
- (4) Remove brake hose from the vehicle by removing the brake hose installation nut.

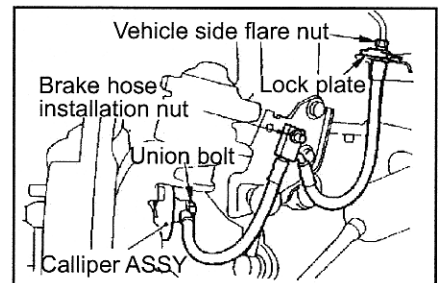

[Vehicle with OPZ25VB type calliper]

- (1) Remove the brake tube flare nut on both vehicle and calliper side using the flare nut wrench.
- (2) Remove lock plate.
- (3) Remove brake hose installation nut to remove brake hose from the vehicle.

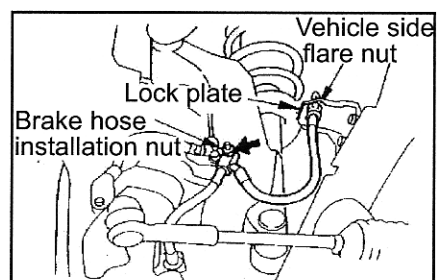
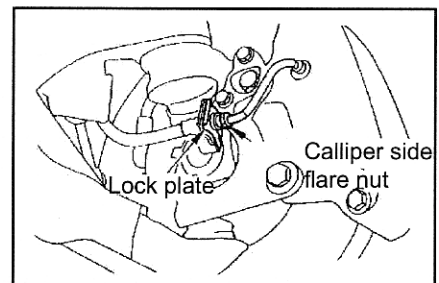

RB20E / RB25DE / RB25DET / RB26DETT ENGINE

[Vehicle with AD9 type calliper]

- (1) Disconnect the brake hose and the brake tube by removing the flare nut on the vehicle side brake tube using the flare nut wrench.
- (2) Remove the union bolt to detach calliper ASSY and brake hose.
- (3) Remove the lock plate and the brake hose from the vehicle.

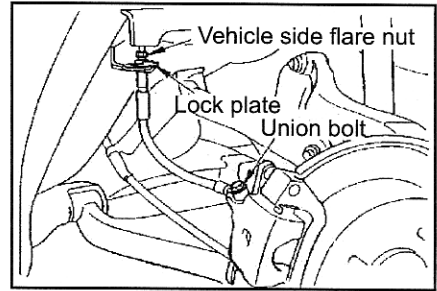

[Vehicle with OPZ11V type calliper]

- (1) Remove the brake tube flare nut on both vehicle and calliper side using the flare nut wrench.
- (2) Remove lock plate.
- (3) Remove brake hose installation bolt to remove brake hose from the vehicle.

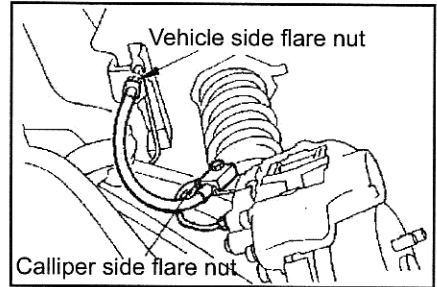

Installation

1. Carry out the procedures below to install the brake hose:

[Vehicle with CL25VA, CL25VD & AD9 type calliper]

- (1) Install the brake hose to calliper ASSY and tighten union bolt to specified torque.
Tightening torque (N-m{kg-m}) 17 ~ 20 {1.7 ~ 2.0}
- (2) Install the brake hose to vehicle side brake tube and tighten the flare nut with your finger. Use lock plate to fix in place and tighten bolt to specified torque.
Tightening torque (N-m{kg-m}) 15 ~ 18 {1.5 ~ 1.8}

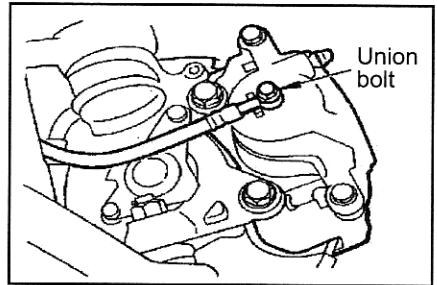

[Vehicle with OPZ25VB & OPZ11V type calliper]

- (1) Install the brake hose to brake tube and tighten flare nut with your hand to install to bracket. After fixing with lock plate tighten bolt to specified torque.
Tightening torque (N-m{kg-m}) 15 ~ 18 {1.5 ~ 1.8}
- (2) Fix the brake hose to the vehicle and tighten installation bolt or nut to specified torque.
Tightening torque (N-m{kg-m}) 20 ~ 23 {2.0 ~ 2.3}

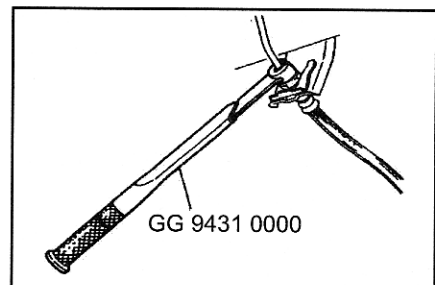

2. Release air after the operation.

5. BRAKE FLUID

Replacement period: Every 2 years

Removal

1. Connect vinyl tube to air breather.
2. Depress the brake pedal to discharge brake fluid from each air breather.

Topping up brake fluid

[Vehicle without ABS device]

1. Clean inside the reservoir tank and top up with new brake fluid.
2. Connect vinyl tube to rear left wheel cylinder air breather to open air breather.
3. Slowly depress the brake pedal fully then release. Wait for 2 to 3 seconds then again slowly depress the brake pedal fully. Repeat the procedure until new brake fluid start to emerge. Close the air breather while depressing the brake pedal.
4. Depress the brake pedal few times then hold the pedal in depressed position. Loosen rear left wheel air breather to release the air, then tighten quickly.
5. Tighten rear breather to specified torque.
Tightening torque (N-m{kg-m}) 6.9 ~ 8.8 {0.7 ~ 0.9}
6. Repeat procedures 2 to 5 for rear right wheel calliper, front left wheel calliper and front right wheel calliper.

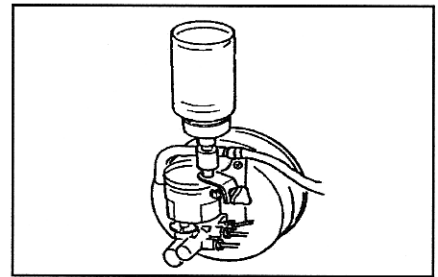
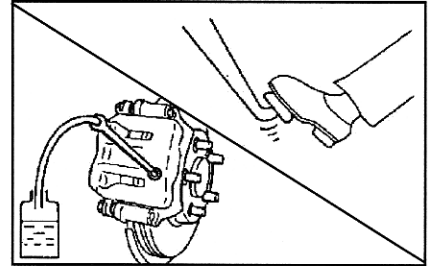

[Vehicle with ABS device]

1. Place ignition switch to OFF position and disconnect ABS actuator connector. OR remove battery terminal.
2. Top up the master cylinder reservoir tank with brake fluid. Carry out the air release operation (procedure 2 to 5 above) making sure reservoir tank is more than half full with brake fluid at all time.

6. MASTER CYLINDER CAP, WHEEL CYLINDER CAP, DISC CALLIPER CAP & DUST SEAL

Replacement period:

Master cylinder cap & dust seal Every 2 years

Wheel cylinder cap & dust seal Every 4 years

MASTER CYLINDER (RB20E / RB25DE / RB25DET)

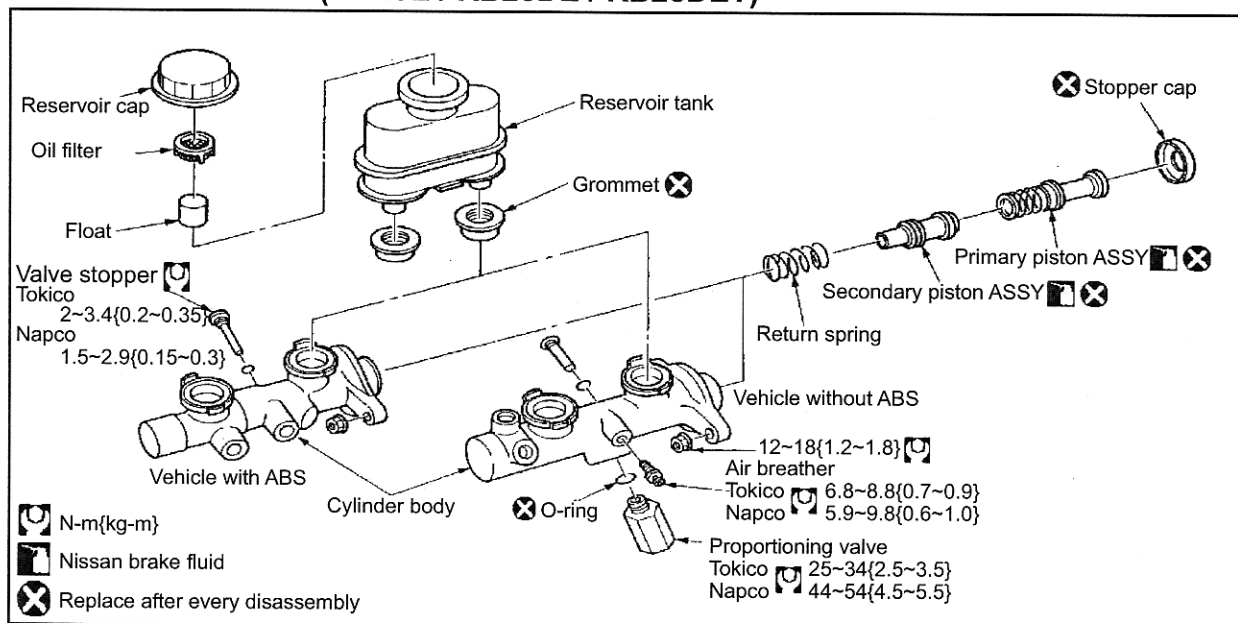

Removal

Caution:

Never remove proportioning valve from the master cylinder.

1. Extract brake fluid from the reservoir tank.
2. Remove harness connector on fluid level sensor.
3. Detach master cylinder and the brake tube using the flare nut wrench.
4. Remove the master cylinder ASSY from the vehicle by removing the installation nut.

Installation

1. Place brake tube flare nut on the master cylinder and tighten by hand.
2. Install master cylinder to brake booster ASSY and tighten installation nut to specified torque.
Tightening torque (N-m{kg-m}) 12 ~ 18 {1.2 ~ 1.8}
3. Tighten brake tube flare nut to specified torque.
Tightening torque (N-m{kg-m}) 15 ~ 18 {1.5 ~ 1.8}
4. Top up with new brake fluid and release the air.

Disassembly

1. Insert a screwdriver into the tab and remove the stopper cap. Hold down the stopper cap to avoid piston pin inside the master cylinder from jumping out.

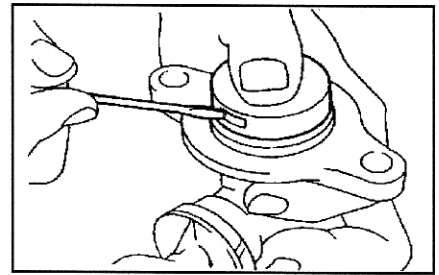

2. Remove the piston stopper from the cylinder body. Use a phillips screwdriver to push the piston inwards to remove the piston stopper.

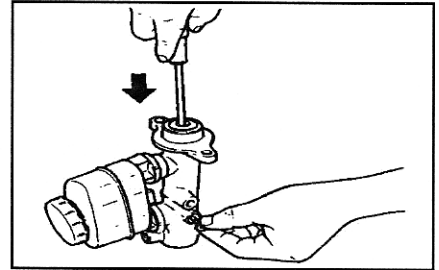

3. Pull out the primary piston ASSY straight so it will not scratch inside wall of the cylinder.
4. Lightly tap the flange with soft objects such as small block of wood etc. so it will not damage inside wall of the cylinder and pull out the secondary piston ASSY.
5. Remove the reservoir tank.

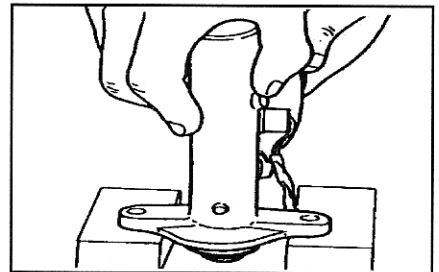

Caution:

Do not remove the reservoir tank unless necessary.

Inspection

Look for any wear, damage, rust or pinhole on the inside wall of the cylinder. Replace the cylinder if there is any fault.

Assembly

Caution:

- Never use gasoline or mineral oil when cleaning or assembling the parts.
- Make sure there is no dust or any foreign objects on the cylinder inside wall, piston or cup seal. Care must be taken not to damage the parts with tools when assembling.
- Never drop any parts. Do not use the part if it has been dropped or damaged in any way.

1. Coat inside the cylinder and the piston pin ASSY contact surface with Nissan brake fluid No. 2500 or Nissan rubber lubricant (KRE12-00030) and insert the secondary piston ASSY into the cylinder body. Next insert the primary piston ASSY.

(Vehicle without ABS)

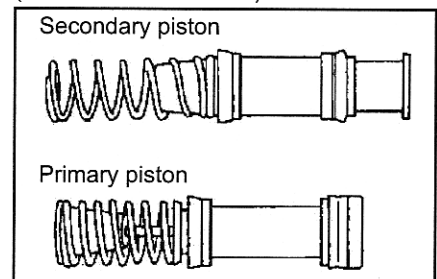

(Vehicle with ABS)

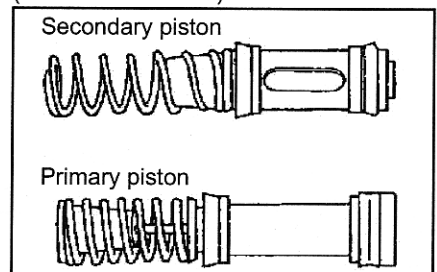

RB20E / RB25DE / RB25DET ENGINE

- Align the secondary piston centre slit to the piston stopper axle and fit them together. Inspect secondary piston slit from the cylinder body piston stopper installation hole to install the piston stopper.

Caution:

Always replace piston stopper O-ring with new ones.

- Install stopper cap.

Insert the piston into the cylinder until it touches the groove by holding the piston down with new stopper cap. Make sure the stopper cap tab is clipped to the cylinder groove.

Caution:

Always replace stopper cap with new ones.

- Install reservoir tank seal to master cylinder.
- Install new reservoir tank to master cylinder.

Caution:

Always replace reservoir tank with new ones once they have been removed.

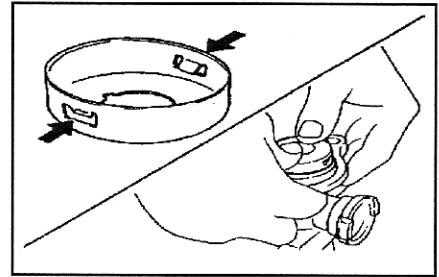
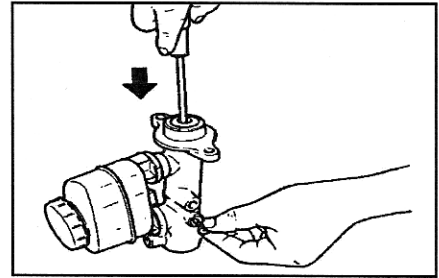

FRONT DISC BRAKE (RB20E / RB25DE / RB25DET)

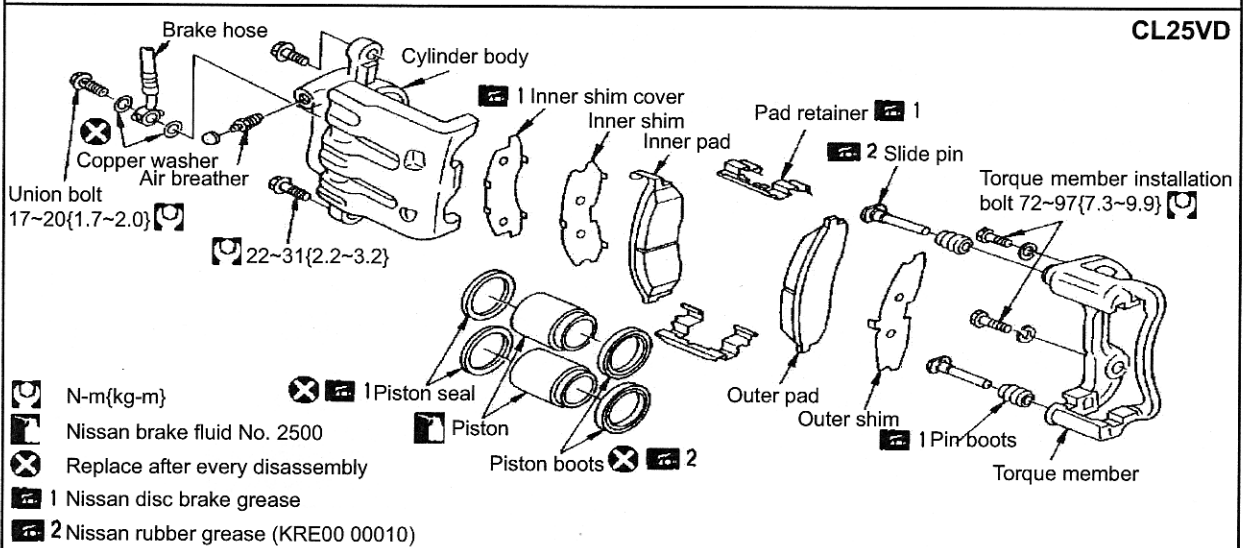
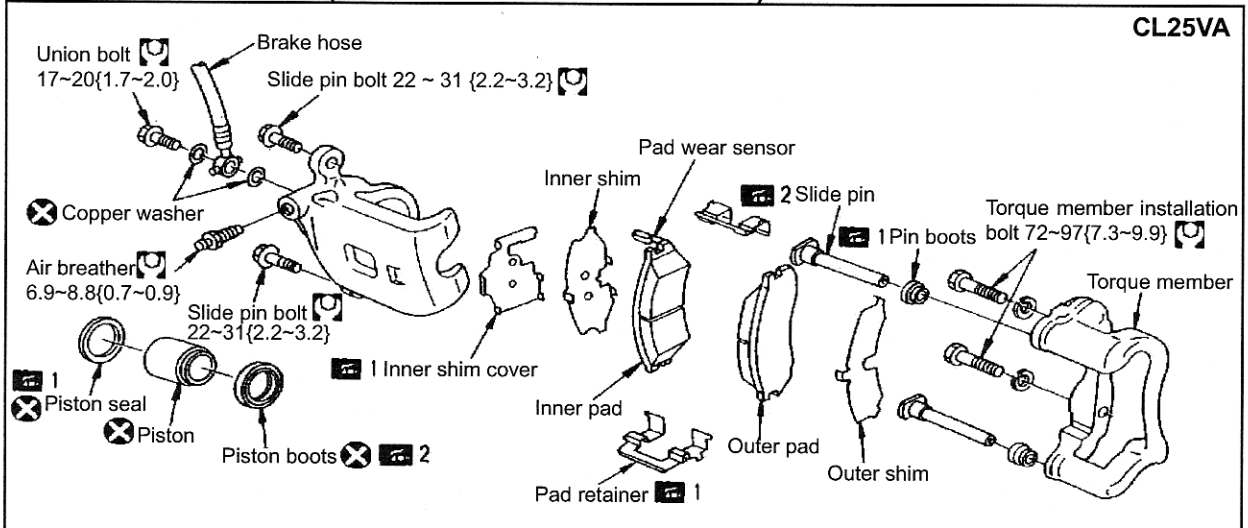

[CL25VA & CL25VD]

Removal

1. Connect vinyl tube to air breather.
2. Depress the brake pedal to discharge brake fluid from each air breather.
3. Disassemble brake hose from the calliper ASSY by removing the union bolts.
4. Remove calliper ASSY from the vehicle by removing the torque member installation bolts.
5. Remove disc rotor.

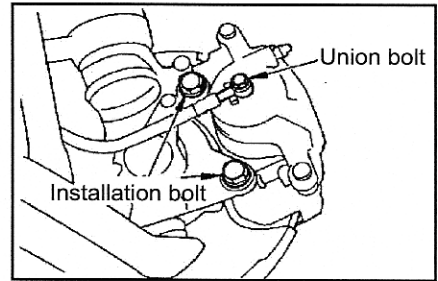

Installation

1. Install brake hose to calliper ASSY and tighten the union bolt by hand.
2. Install calliper ASSY to the vehicle and tighten installation bolts to specified torque.
Tightening torque (N-m{kg-m}) 72 ~ 97{7.3 ~ 9.9}
3. Tighten union bolt to specified torque.
Tightening torque (N-m{kg-m}) 17 ~ 20{1.7 ~ 2.0}
4. After installing the calliper ASSY, top up with new brake fluid and release the air.

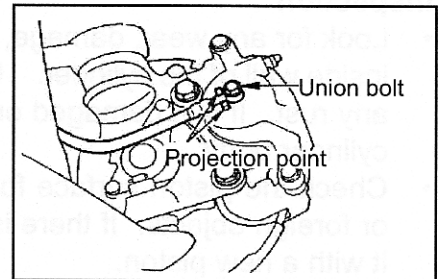

Disassembly

1. Remove pad, shim, shim cover and pad retainer from the calliper ASSY.
2. Remove slide pin bolt and torque member from the cylinder body.
3. Remove slide pin and slide pin boots from the torque member.
4. Insert a block of wood as shown in the diagram on the right. Blow in some compressed air through union bolt installation hole then remove piston boots. At this time, if one side of CL25V type piston comes off, push in the fallen piston a little further into the cylinder body and then blow with compressed air again.

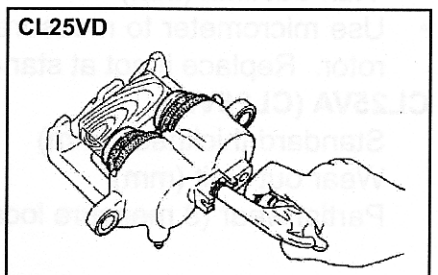
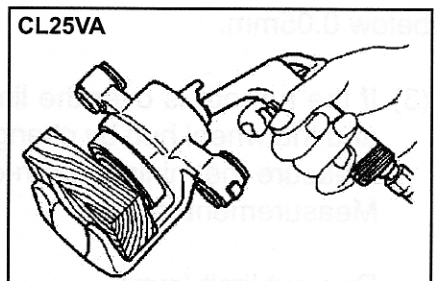
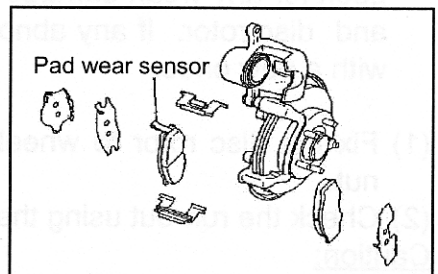

5. Use screwdriver to remove piston seal.

Caution:

Care must be taken not to damage inside the cylinder.

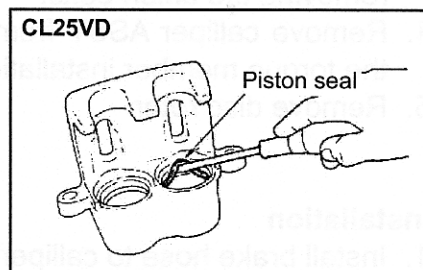
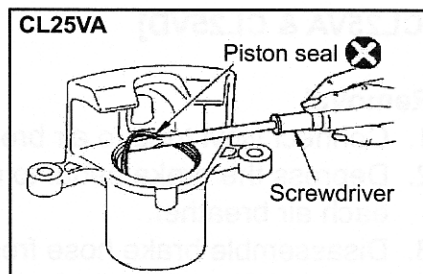

Inspection

- Look for any wear, damage, rust or pinhole on the inside wall of the cylinder. Use sandpaper to remove any rust. If it is damaged or worn replace it with new cylinder body.
- Check the piston surface for any rust, wear, damage or foreign objects. If there is any abnormality replace it with a new piston.

Caution:

Only use new brake fluid for cleaning. Never use gasoline, benzine or mineral oil.

- Look for any wear, damage or cracks on the slide pin and disc rotor. If any abnormality is found replace it with a new ones.

(1) Fix the disc rotor to wheel hub by using the wheel nut.

(2) Check the run-out using the dial gauge.

Caution:

Before measurement make sure the axle end play is below 0.05mm.

(3) If the run-out is over the limit re attach the disc rotor and the wheel hub by changing one hole for each and measure the minimum run-out value.

Measurement location	Measure at 10mm inside the radial
Run-out limit (mm)	0.07

- Use micrometer to measure the thickness of the disc rotor. Replace if not at standard measure.

CL25VA (CL25VD)

Standard thickness (mm)	22 (26)
Wear out limit (mm)	20 (24)
Partial wear (8 measure location) (mm)	0.02 (0.02)

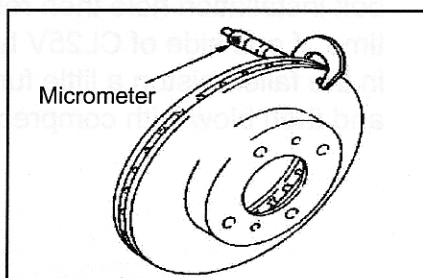
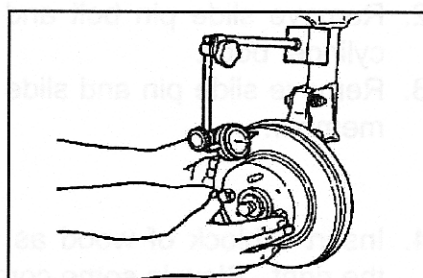

RB20E / RB25DE / RB25DET ENGINE

Assembly

1. Apply Nissan rubber lubricant to piston seal then install it to the cylinder body.

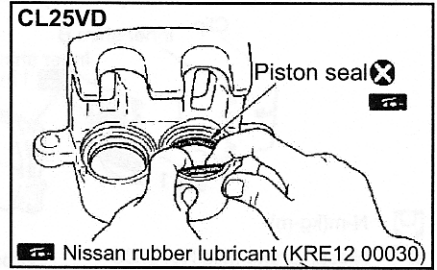
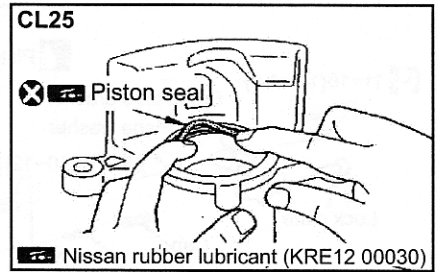

2. Apply Nissan brake fluid No. 2500 or Nissan rubber lubricant (KRE12 00030) to piston boots and cover piston tip. Install piston cylinder side lip to cylinder body groove correctly.
3. Push in the piston into cylinder body and install piston boots piston side lip into the piston groove.

Caution:

When inserting the piston, care must be taken not to damage the cylinder inside wall.

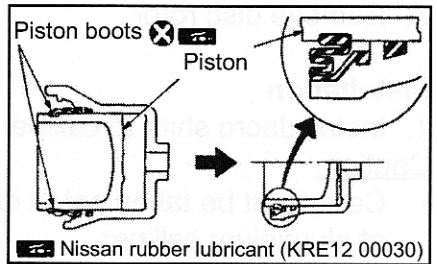
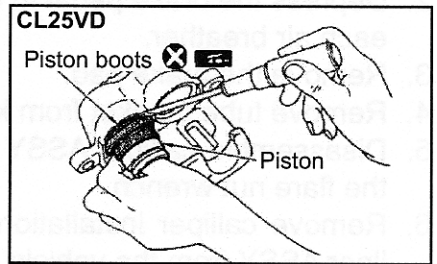
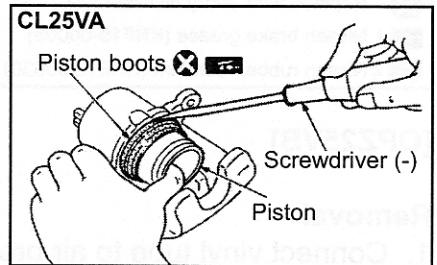

RB20E / RB25DE / RB25DET ENGINE

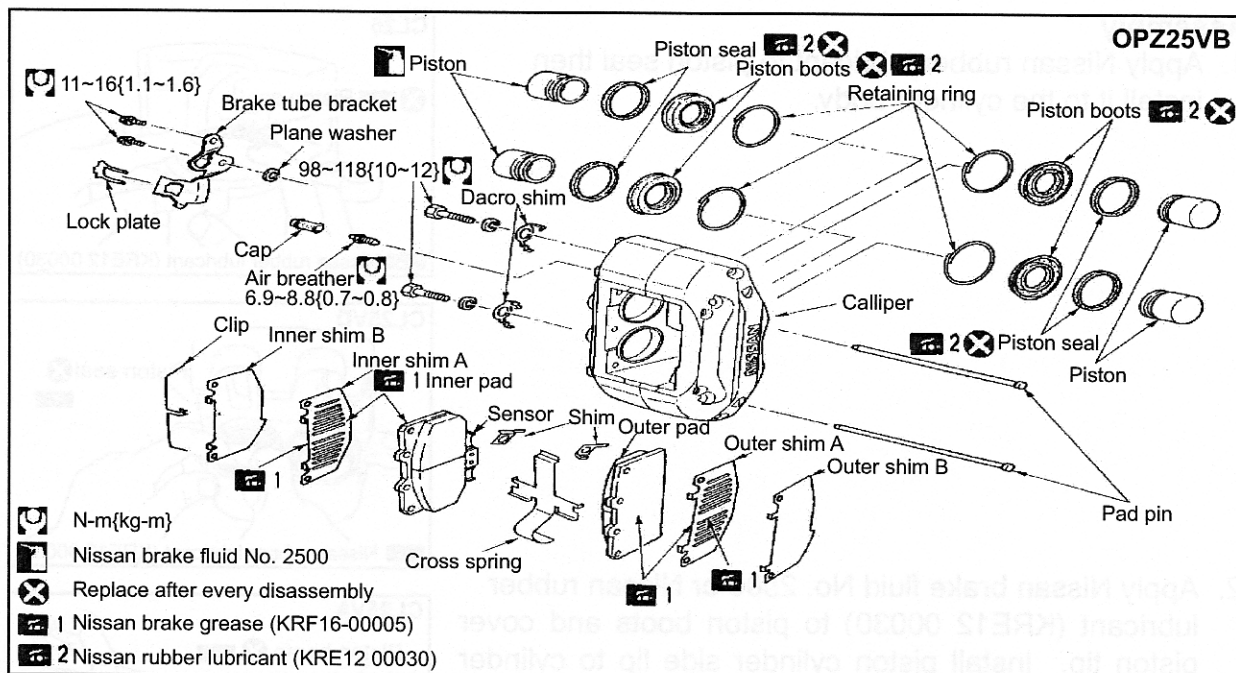

[OPZ25VB]

Removal

1. Connect vinyl tube to air breather.
2. Depress the brake pedal to discharge brake fluid from each air breather.
3. Remove the brake pad.
4. Remove tube bracket from knuckle spindle.
5. Disassemble calliper ASSY and the brake tube using the flare nut wrench.
6. Remove calliper installation bolt to disassemble calliper ASSY from the vehicle.
7. Remove disc rotor.

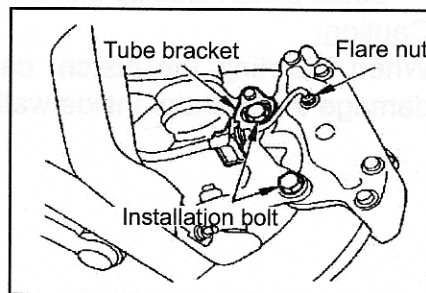

Installation

1. Install dacro shim to calliper installation surface.

Caution:

- Care must be taken not to damage installation surface of aluminium calliper.
- There must be no moisture or grease adhered to installation surface of the knuckle, calliper, installation bolts and washer.

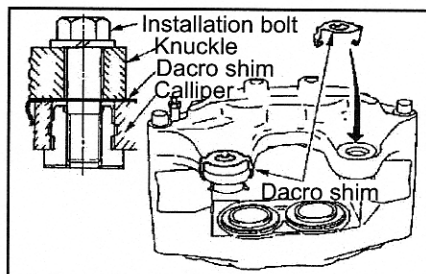

2. Attach brake tube to calliper ASSY and tighten flare nut by hand.

3. Install calliper ASSY to the vehicle and tighten the bolts to specified torque.

Tightening torque (N-m{kg-m}) 98~118{10~12}

4. Tighten flare nuts to specified torque.

Tightening torque (N-m{kg-m}) 11~16{1.1~1.6}

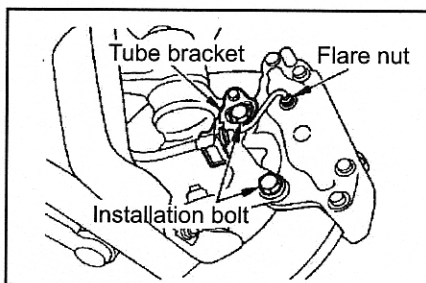

RB20E / RB25DE / RB25DET ENGINE

5. Install tube bracket to knuckle spindle and tighten to specified torque.
Tightening torque (N-m{kg-m}) 11~16{1.1~1.6}
6. Install brake pad.
7. After installing the calliper ASSY, top up with new brake fluid and release air.

Disassembly

1. Remove pad and the shim from the calliper ASSY.
2. Remove the flare nut, lock plate and calliper installation bolt, then remove the calliper.
3. Use screwdriver as shown in the diagram on the right to remove retaining ring.

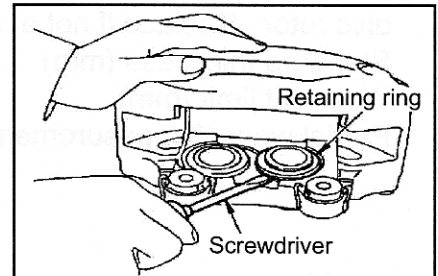

4. Insert a block of wood as shown in the diagram on the right. Blow in some compressed air through flare nut installation hole to remove piston pin and the piston boots. At this time, if all four piston does not disassemble equally, push in the disassembled piston a little further into the cylinder body and then blow with compressed air again.

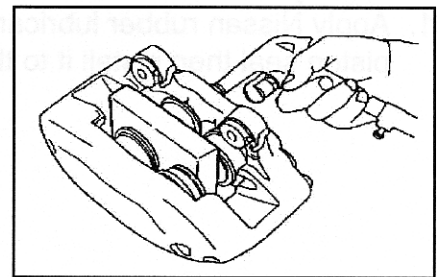

5. Remove piston boots from the piston.

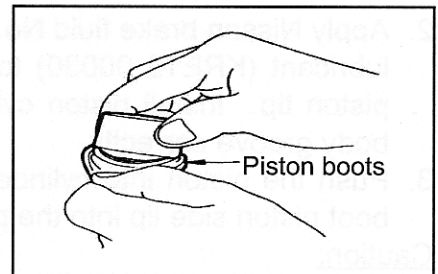

6. Use screwdriver to remove the piston seal.

Caution:

Care must be taken not to damage cylinder inside surface.

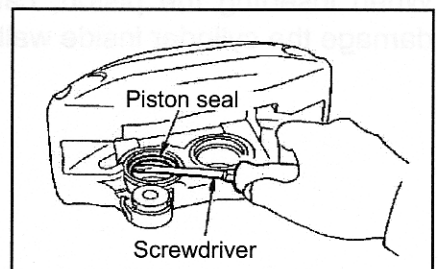

Inspection

- Look for any wear, damage, rust or pinhole on the inside wall of the cylinder. Use sandpaper to remove any rust. If it is damaged or worn replace it with new cylinder body.
- Check the piston surface for any rust, wear, damage or foreign objects. If there is any abnormality replace it with a new piston.

- (1) Fix the disc rotor to wheel hub by using the wheel nut.

- (2) Check the runout using the dial gauge.

Caution:

Before measurement make sure the axle end play is

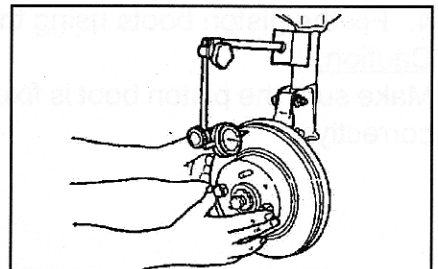

RB20E / RB25DE / RB25DET ENGINE

- (3) If the runout is over the limit reattach the disc rotor and the wheel hub by changing one hole for each and measure the minimum runout value.

Measurement location	Measure at 10mm inside the radial
Runout limit (mm)	0.07

- Use a micrometer to measure the thickness of the disc rotor. Replace if not at standard measurement.

Standard thickness (mm)	30
Wear out limit (mm)	28
Partial wear (8 measurement location)(mm)	0.02

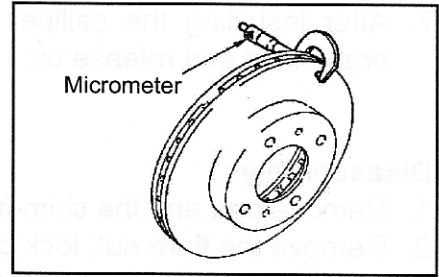

Assembly

- Apply Nissan rubber lubricant (KRE12 00030) to piston seal then install it to the cylinder body.

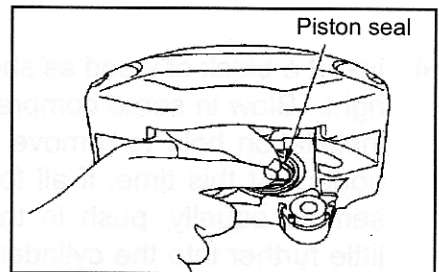

- Apply Nissan brake fluid No. 2500 or Nissan rubber lubricant (KRE12 00030) to piston boots and cover piston tip. Install piston cylinder side lip to cylinder body groove correctly.

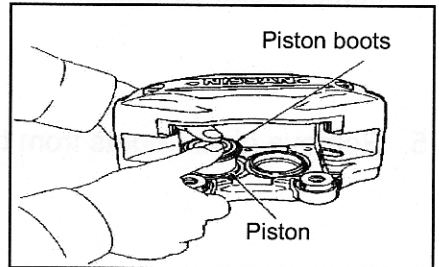

- Push the piston into cylinder body and install piston boot piston side lip into the piston groove.

Caution:

When inserting the piston, care must be taken not to damage the cylinder inside wall.

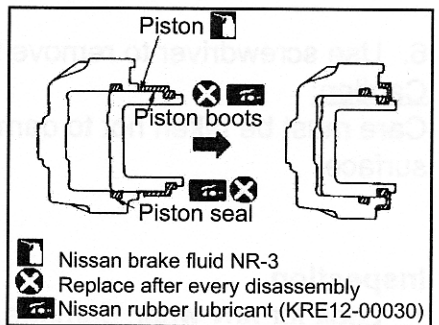

- Fix the piston boots using the retaining ring.

Caution:

Make sure the piston boot is fixed in cylinder body groove correctly.

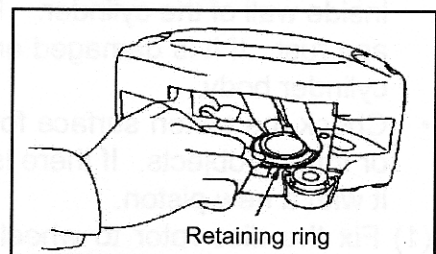

RB20E / RB25DE / RB25DET ENGINE

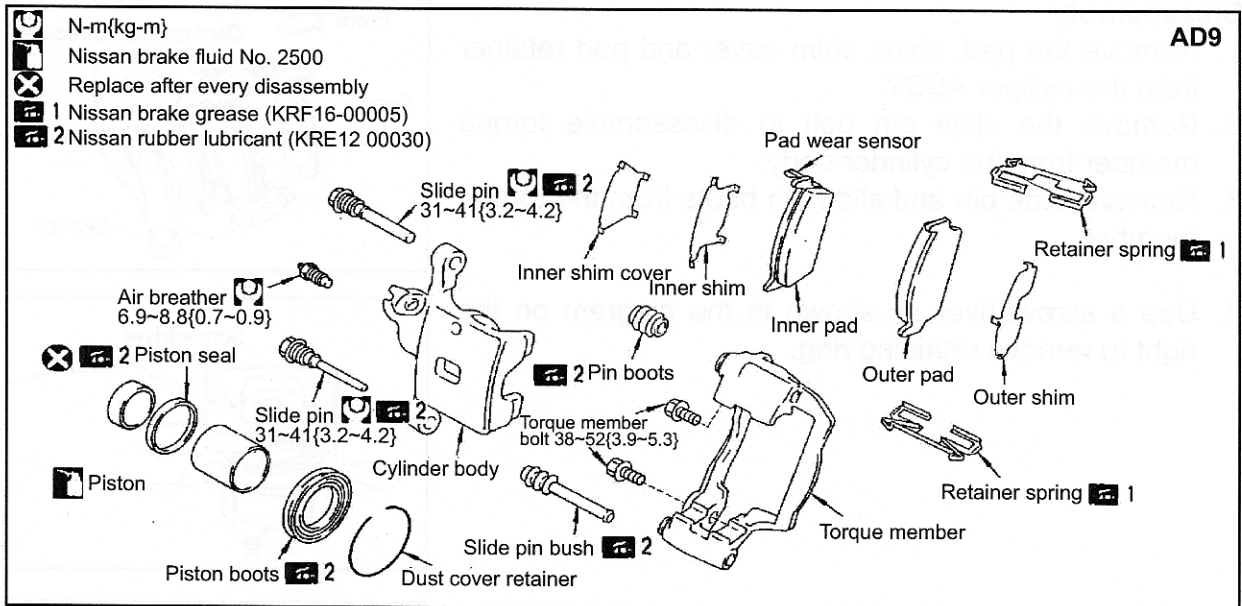

[AD9]

Removal

1. Connect vinyl tube to the air bleather.
2. Depress the brake pedal to discharge brake fluid from each air bleather.
3. Detach the brake hose connected to the calliper ASSY by removing the union bolts.
4. Remove the calliper ASSY from the vehicle by removing the torque member installation bolts.
5. Remove the disc rotor.

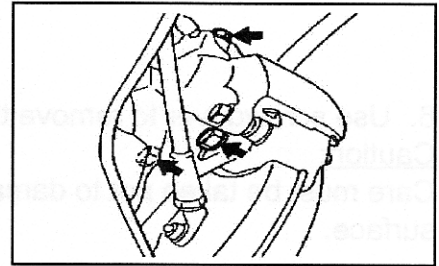

Installation

1. Attach the brake hose to the calliper ASSY and tighten installation union bolts by hand.
2. Attach calliper ASSY to the vehicle and tighten the installation bolts to specified torque.
 Tightening torque (N-m{kg-m}) 38~52{3.8~5.3}
3. Tighten the flare nut to specified torque.
 Tightening torque (N-m{kg-m}) 17~20{1.7~2.0}
4. Top up with new brake fluid and release air.

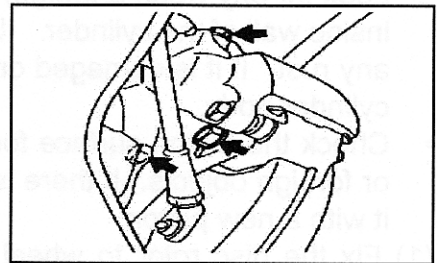

Disassembly

1. Remove the pad, shim, shim cover and pad retainer from the calliper ASSY.
2. Remove the slide pin bolt to disassemble torque member from the cylinder body.
3. Remove slide pin and slide pin boots from the torque member.
4. Use a screwdriver as shown in the diagram on the right to remove retaining ring.

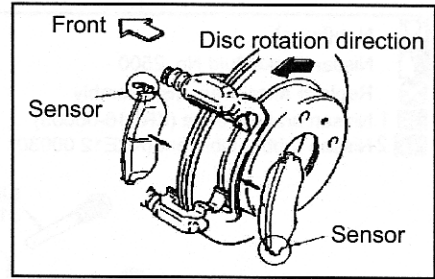

5. Insert a block of wood as shown in the diagram on the right. Blow in some compressed air through the union bolt installation hole to remove piston boots.

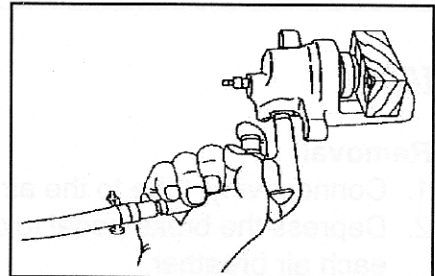
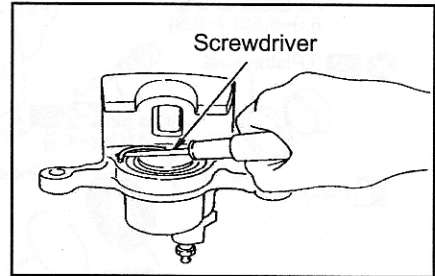

6. Use screwdriver to remove the piston seal.

Caution:

Care must be taken not to damage cylinder inside surface.

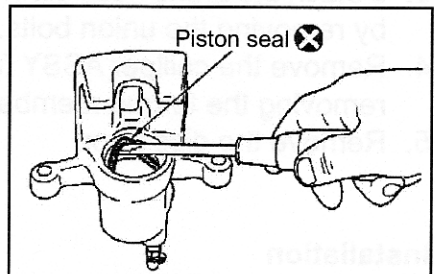

Inspection

- Look for any wear, damage, rust or pinhole on the inside wall of the cylinder. Use sandpaper to remove any rust. If it is damaged or worn replace it with new cylinder body.
- Check the piston surface for any rust, wear, damage or foreign objects. If there is any abnormality replace it with a new piston.

- (1) Fix the disc rotor to wheel hub by using the wheel nut.
- (2) Check the runout using the dial gauge.

Caution:

Before measurement make sure the axle end play is below 0.05mm.

- (3) If the runout is over the limit re-attach the disc rotor and the wheel hub by changing one hole for each and measure the minimum runout value. OR use grinding machine to adjust to standard value. After grinding check the rotor thickness and replace the disc rotor if it is not at standard value.

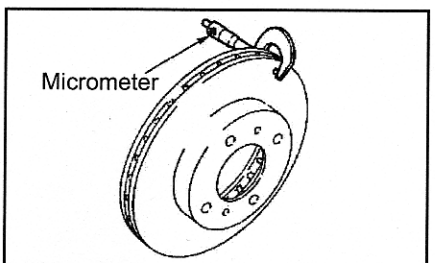
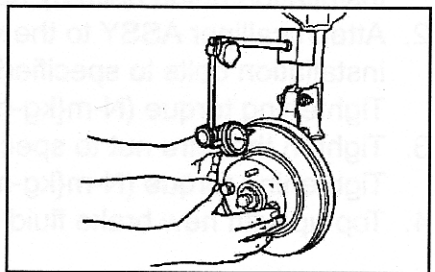

RB20E / RB25DE / RB25DET ENGINE

Measurement location	Measure at 10mm inside the radial
Runout limit (mm)	0.07

- Use micrometer to measure the thickness of the disc rotor. Replace if not at standard measure.

Standard thickness (mm)	9
Wear out limit (mm)	8
Partial wear (8 measurement location)(mm)	0.02

Assembly

1. Apply Nissan rubber lubricant to piston seal then install it to the cylinder body.

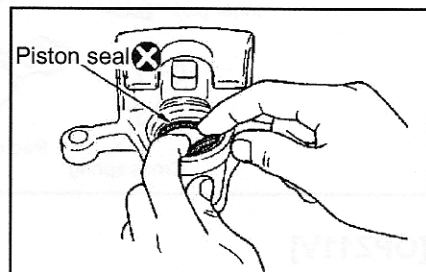

2. Apply Nissan brake fluid No. 2500 or Nissan rubber lubricant (KRE12 00030) to piston boots and cover piston end. Install piston cylinder side lip to cylinder body groove correctly.
3. Push in the piston into cylinder body and install piston boot piston side lip into the piston groove.

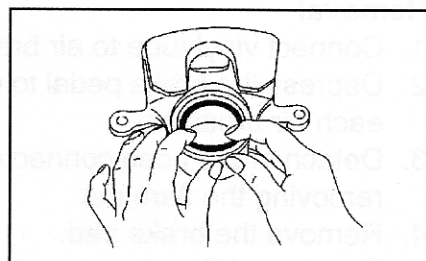

Caution:

When inserting the piston, care must be taken not to damage the cylinder inside wall.

4. Fix the piston boots using retaining.

Caution:

Make sure piston boot is fixed in cylinder body groove correctly.

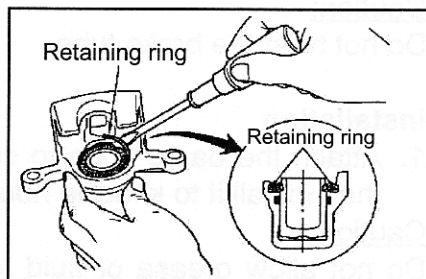

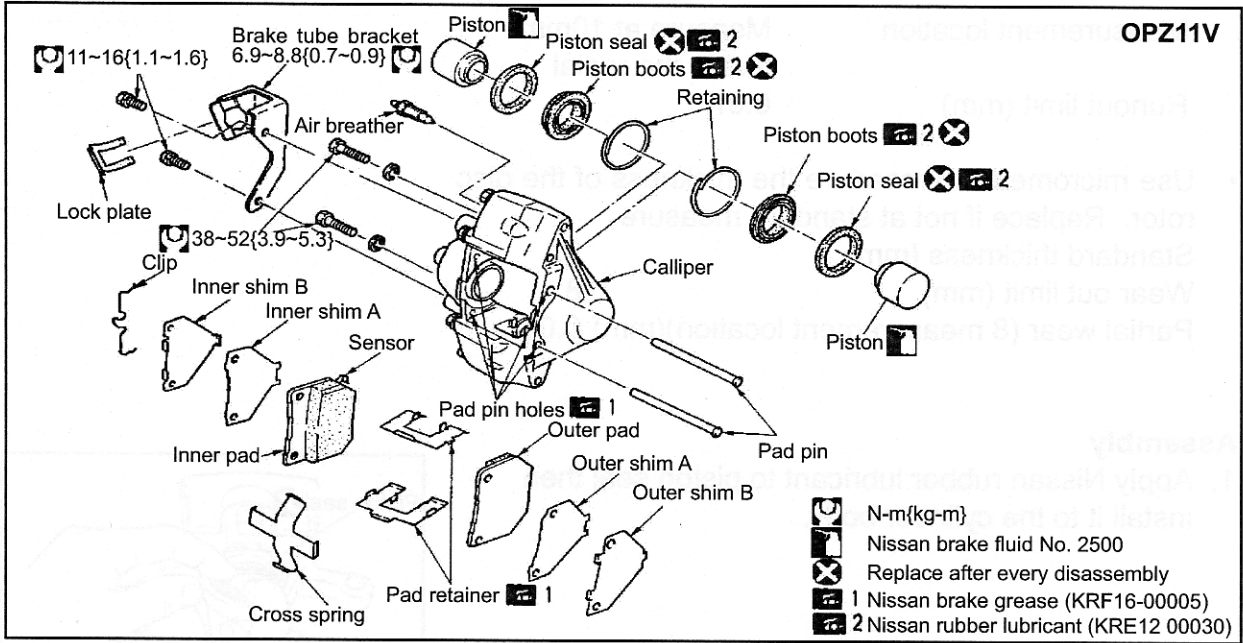

[OPZ11V]

Removal

1. Connect vinyl tube to air breather.
2. Depress the brake pedal to discharge brake fluid from each air breather.
3. Detach brake hose connected to the calliper ASSY by removing the flare nut.
4. Remove the brake pad.
5. Remove calliper by removing the installation bolt.

Caution:

Do not twist the brake tube.

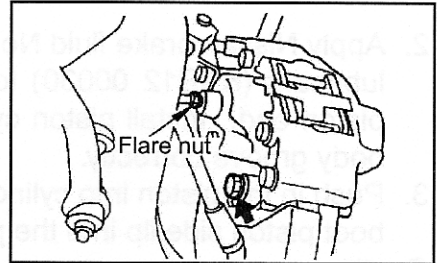

Installation

1. Attach the dacro shim to calliper installation surface then install it to knuckle housing.

Caution:

Do not allow grease or fluid to adhered to the knuckle installation surface, calliper surface, bolts and washer.

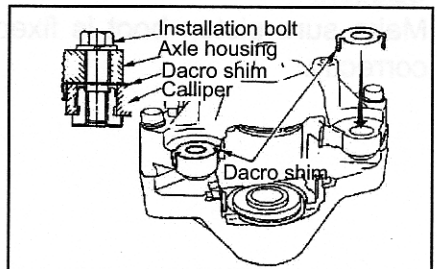

2. Install brake tube to the calliper ASSY and tighten the flare nut.
3. Install calliper ASSY to the vehicle and tighten installation bolts to specified torque.
Tightening torque (N-m{kg-m}) 38~52{3.8~5.3}
4. Install the brake pad.
5. Tighten the flare nut to specified torque.
Tightening torque (N-m{kg-m}) 11~16{1.1~1.6}
6. Top up with new brake fluid and release the air.

Disassembly

1. Remove pad and shim from the calliper ASSY.
2. Remove the flare nut, lock plate and installation bolts and remove the calliper.
3. Use screwdriver as shown in the diagram on the right to remove retaining ring.

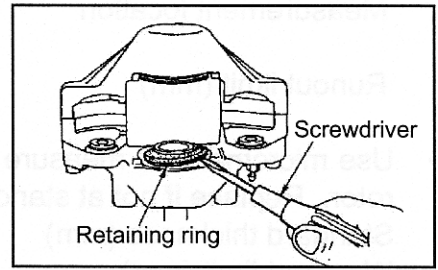

4. Insert a block of wood as shown in the diagram on the right. Blow in some air from flare nut installation hole to remove piston pin and piston boots. At this time, if two pistons do not disassemble equally, push in the disassembled piston a little further into the cylinder body and then blow the air again.

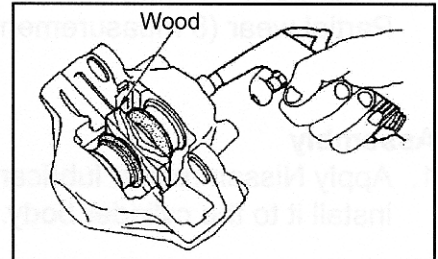

5. Remove piston boots from the piston.

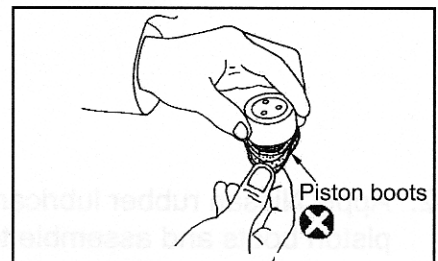

6. Use screwdriver to remove the piston seal.

Caution:

Care must be taken not to damage cylinder inside surface.

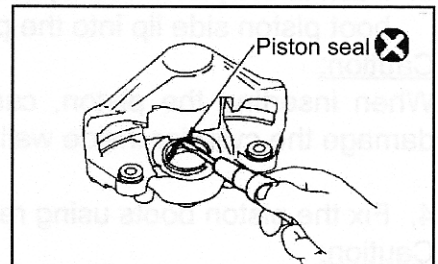

Inspection

- Look for any wear, damage, rust or pinhole on the inside wall of the cylinder. Use sandpaper to remove any rust. If it is damaged or worn replace it with new cylinder body.
- Check the piston surface for any rust, wear, damage or foreign objects. If there is any abnormality replace it with a new piston.

- (1) Fix the disc rotor to wheel hub by using the wheel nut.
- (2) Check the runout using the dial gauge.

Caution:

Before measurement make sure the axle end play is below 0.05mm.

- (3) If the runout is over the limit re-attach the disc rotor and the wheel hub by changing one hole for each and measure the minimum runout value. OR use grinding machine to adjust to standard value. After grinding check the rotor thickness and replace the disc rotor if it is not at standard value.

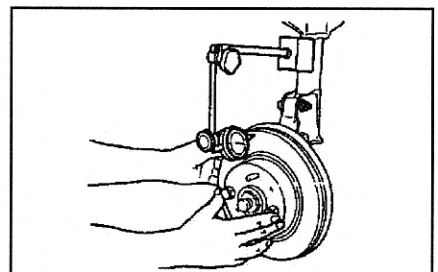

RB20E / RB25DE / RB25DET ENGINE

Measurement location	Measure at 10mm inside the radial
Runout limit (mm)	0.1

- Use micrometer to measure the thickness of the disc rotor. Replace if not at standard measure.
- | | |
|---|------|
| Standard thickness (mm) | 18 |
| Wear out limit (mm) | 16 |
| Partial wear (8 measurement location)(mm) | 0.02 |

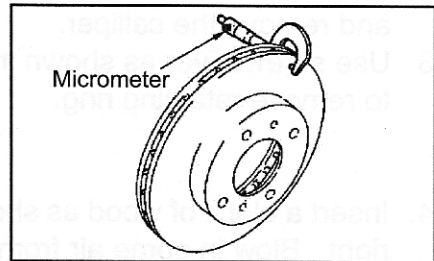

Assembly

1. Apply Nissan rubber lubricant to piston seal then install it to the cylinder body.

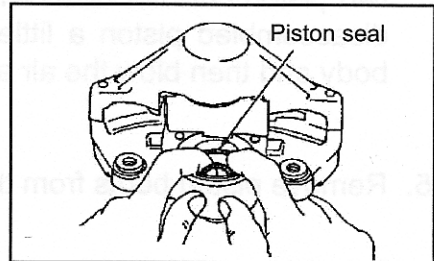

2. Apply Nissan rubber lubricant (KRE12 00030) to piston boots and assemble to piston groove securely.
3. Push in the piston into cylinder body and install piston boot piston side lip into the piston groove.

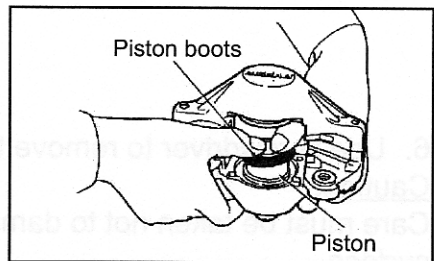

Caution:

When inserting the piston, care must be taken not to damage the cylinder inside wall.

4. Fix the piston boots using retaining ring.

Caution:

Make sure the piston boot is fixed in cylinder body groove correctly.

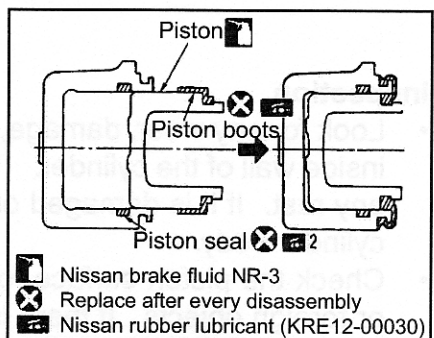

RB26DETT ENGINE

6. MASTER CYLINDER CAP, WHEEL CYLINDER CAP, DISC CALLIPER CAP & DUST SEAL

MASTER CYLINDER (RB26DETT ENGINE)

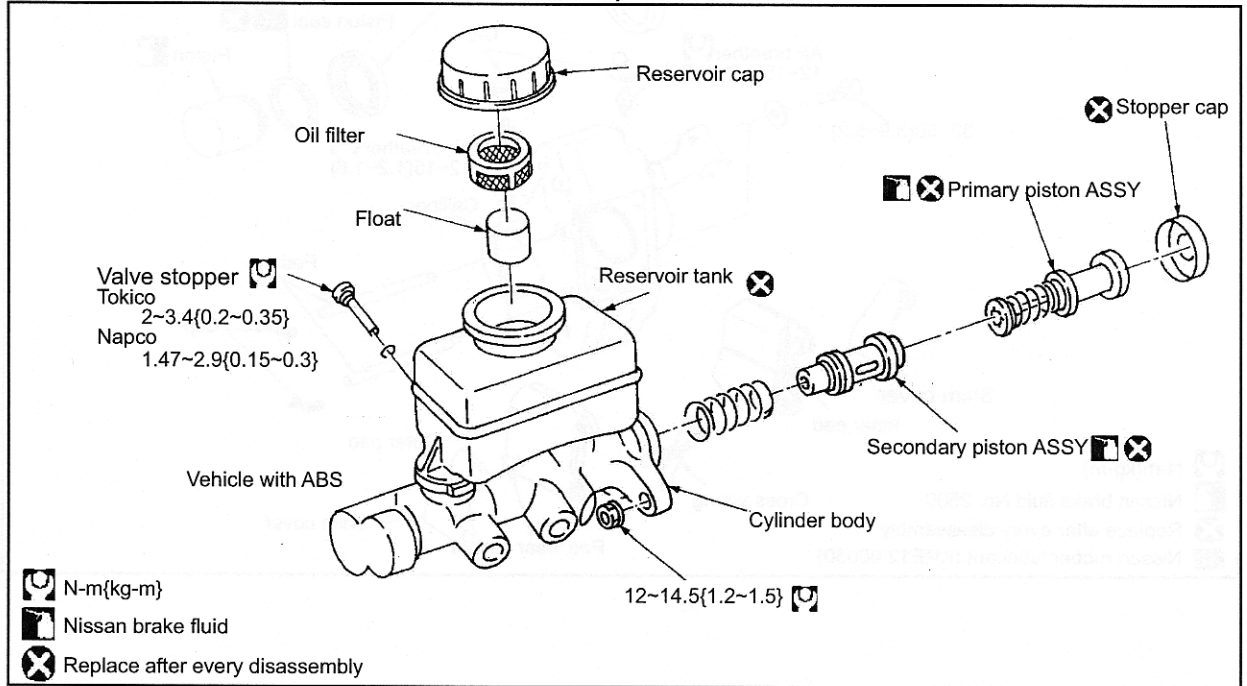

FRONT DISC BRAKE

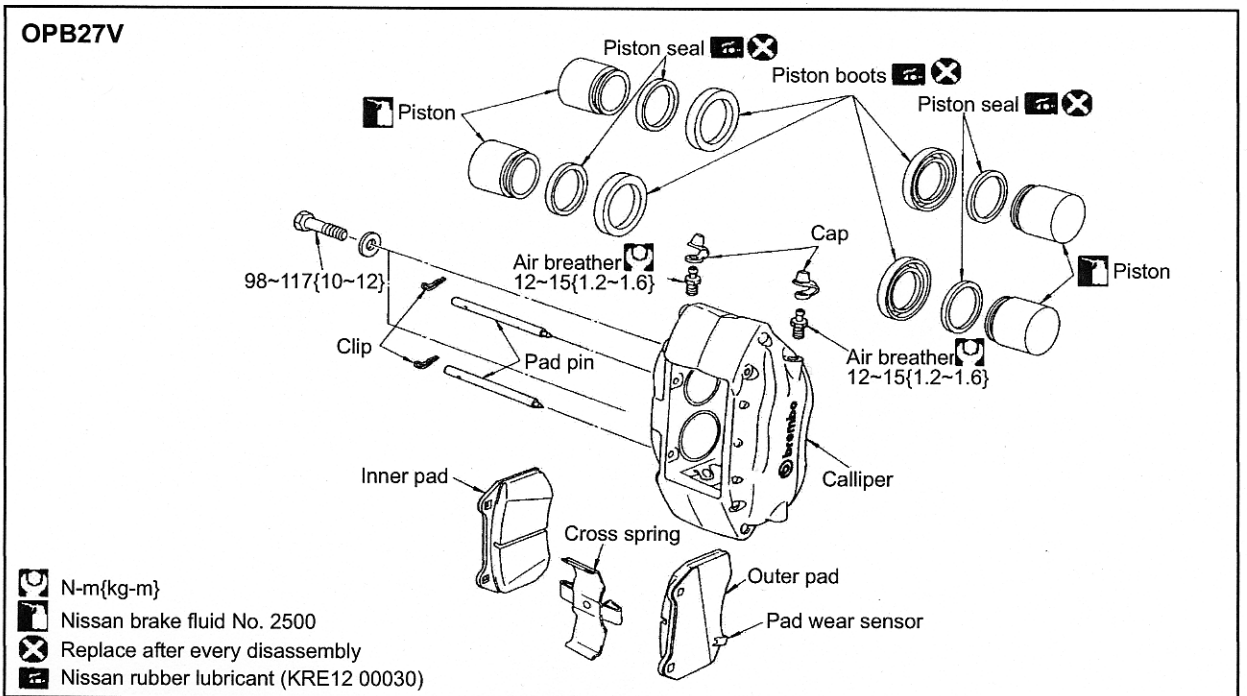

RB26DETT ENGINE

REAR DISC BRAKE

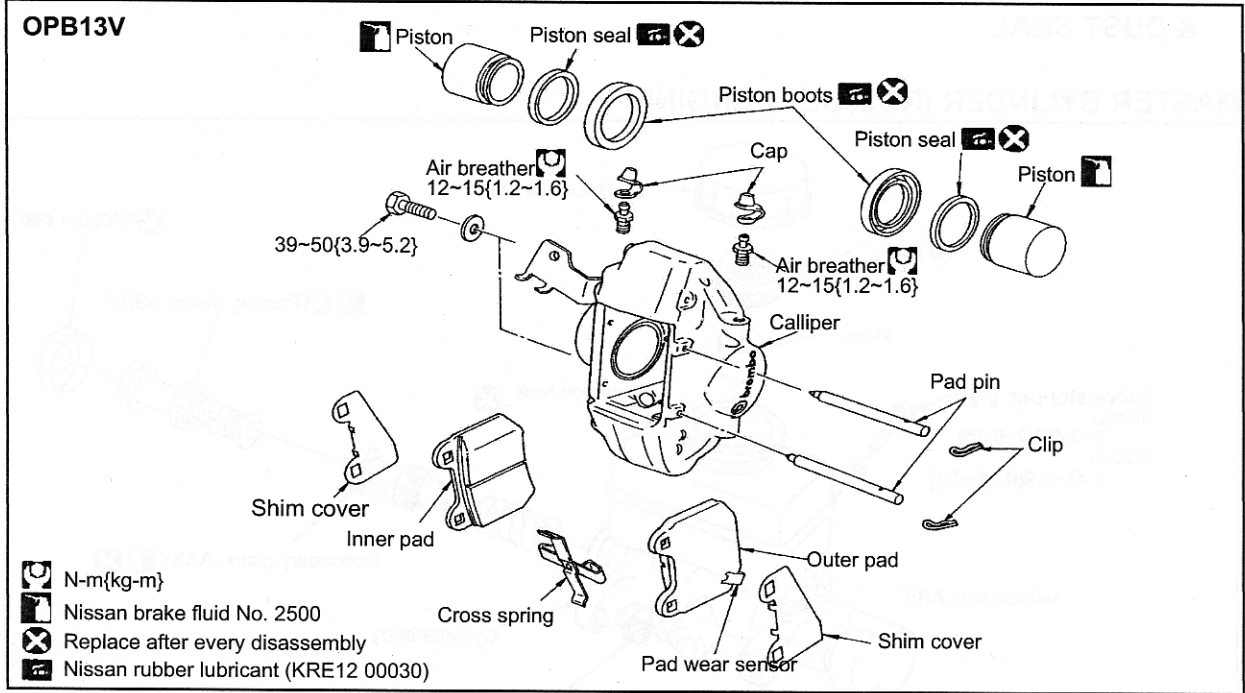

RB25DE / RB25DET ENGINE

7. SPARK PLUG (RB25DE / RB25DET)

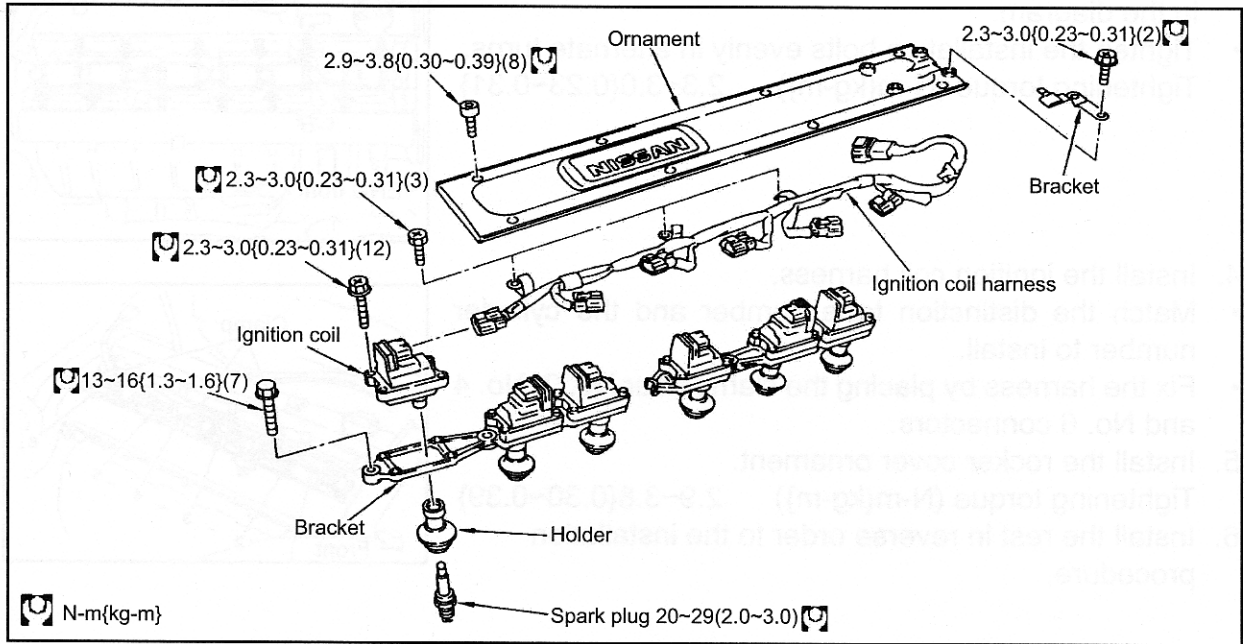

Removal

1. Disconnect negative battery terminal inside the engine room.
2. Remove the air duct.
3. Remove blowby hose between the rocker cover intake and the exhaust side (RB25DE).
4. Disconnect ignition coil harness connector.
5. Remove the rocker cover ornament.
6. Disconnect ignition coil connector.
7. Remove the ignition coil.
8. Use spark plug wrench to remove the spark plug.

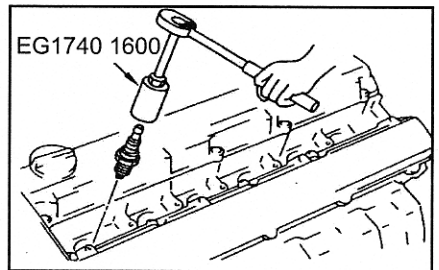
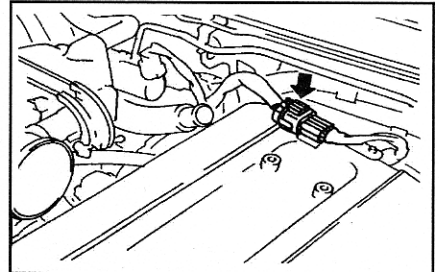

Installation

1. Use spark plug wrench to install spark plug.
Tightening torque (N-m{kg-m}) 20~29{2.0~3.0}
2. Install the ignition coil bracket.
 - Install the ignition coil bracket with mark "F" to front side. Make sure the arrow is facing the front.
 - Install the ignition coil bracket with mark "R" to rear, make sure the arrow is facing the back.
Tightening torque (N-m{kg-m}) 13~16{1.3~1.6}
3. Install the ignition coil.

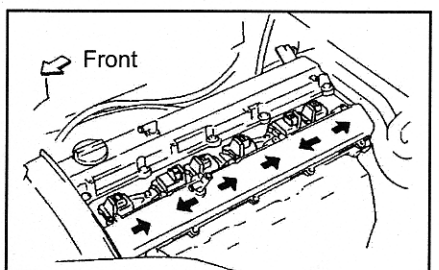
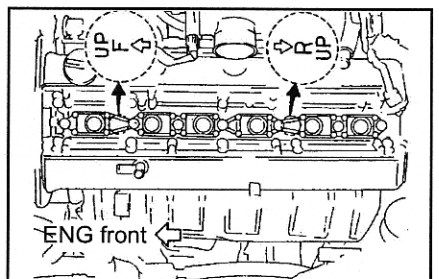

RB25DE / RB25DET ENGINE

- Install the installation bolts at marked position shown in the diagram.
- Tighten the installation bolts evenly in alternate turns. Tightening torque (N-m{kg-m}) 2.3~3.0{0.23~0.31}

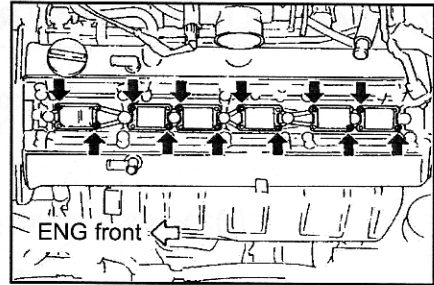

4. Install the ignition coil harness.
 - Match the distinction tape number and the cylinder number to install.
 - Fix the harness by placing the clamp near No. 2, No. 4 and No. 6 connectors.
5. Install the rocker cover ornament. Tightening torque (N-m{kg-m}) 2.9~3.8{0.30~0.39}
6. Install the rest in reverse order to the installation procedure.

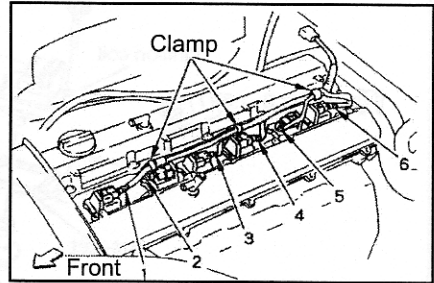

Removal
 1. Disconnect negative battery terminal inside the engine room.
 2. Remove the air duct.
 3. Remove clowby hose between the rocker cover intake and the exhaust side (RB25DE).
 4. Disconnect ignition coil harness connector.
 5. Remove the rocker cover ornament.
 6. Disconnect ignition coil connector.
 7. Remove the ignition coil.
 8. Use spark plug wrench to remove the spark plug.

Installation
 1. Use spark plug wrench to install spark plug. Tightening torque (N-m{kg-m}) 20~30(2.0~3.0).
 2. Install the ignition coil bracket.
 3. Install the ignition coil bracket with mark 'F' to front side. Make sure the arrow is facing the front.
 4. Install the ignition coil bracket with mark 'R' to rear. Make sure the arrow is facing the back.
 5. Tightening torque (N-m{kg-m}) 13~16(1.3~1.6).

7. Install the ignition coil.

RB26DETT ENGINE

7. SPARK PLUG (RB26DETT)

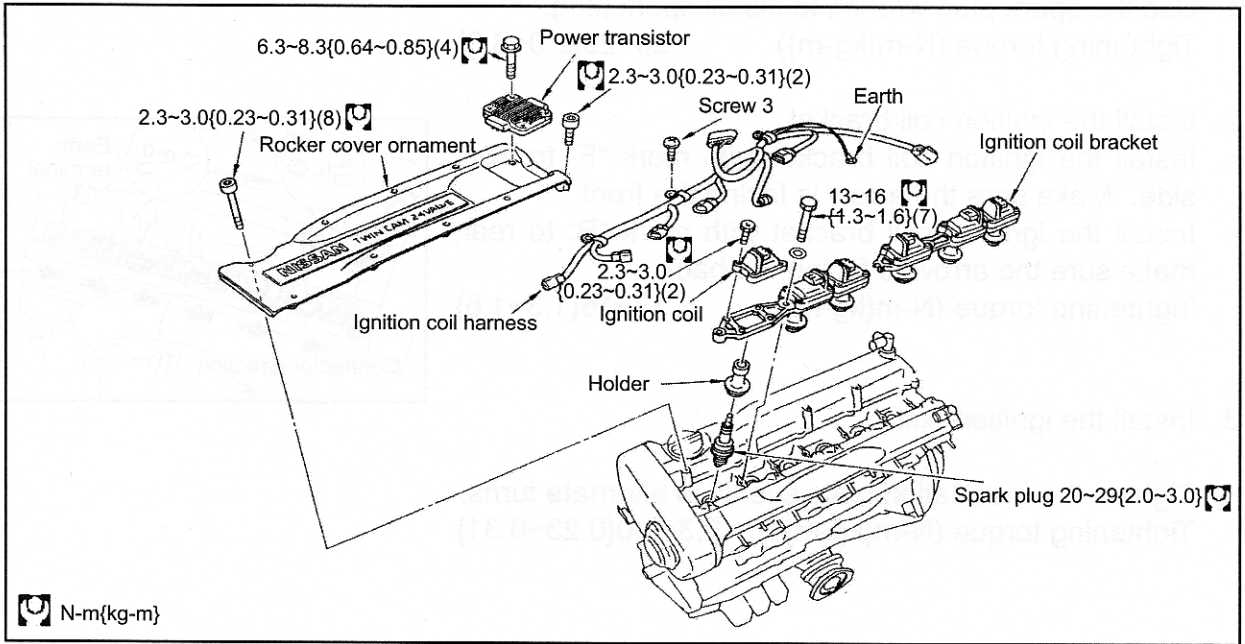

Removal

1. Disconnect the negative battery terminal in the engine room.
2. Remove the rocker cover ornament.
 - (1) Remove the blowby hose between right and left rocker cover.
 - (2) Remove the rear side connector and earth terminal from the power transistor unit.
 - (3) Lift up the rocker cover ornament and remove power transistor unit front connector from reverse side.
3. Remove the power transistor unit from the rocker cover ornament.
4. Disconnect the ignition coil harness connector.
5. Remove the ignition coil.
6. Use the spark plug wrench to remove the spark plug.

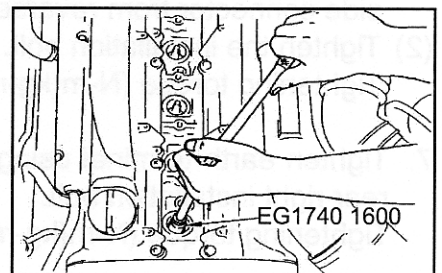
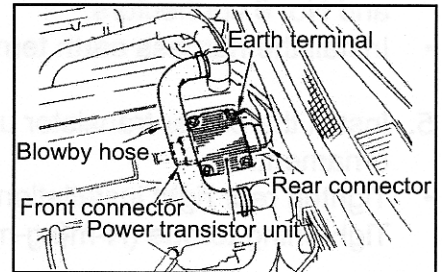

RB26DETT ENGINE

Installation

1. Use the spark plug wrench to install spark plug.
Tightening torque (N-m{kg-m}) 20~29{2.0~3.0}

2. Install the ignition coil bracket.

- Install the ignition coil bracket with mark "F" to front side. Make sure the arrow is facing the front.
 - Install the ignition coil bracket with mark "R" to rear, make sure the arrow is facing the back.
- Tightening torque (N-m{kg-m}) 13~16{1.3~1.6}

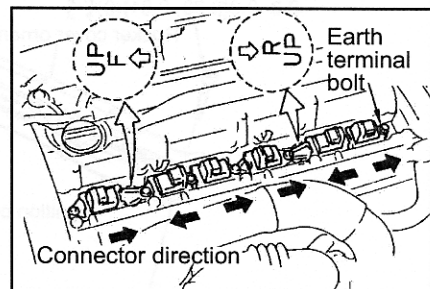

3. Install the ignition coil.

- Tighten the installation bolts evenly in alternate turns.
- Tightening torque (N-m{kg-m}) 2.3~3.0{0.23~0.31}

4. Install the ignition coil harness.

- Match the distinction tape number and the cylinder number to install.
- Fix the harness by placing the clamp near No. 2, No. 4 and No. 6 connectors.
- Install the harness earth terminal.

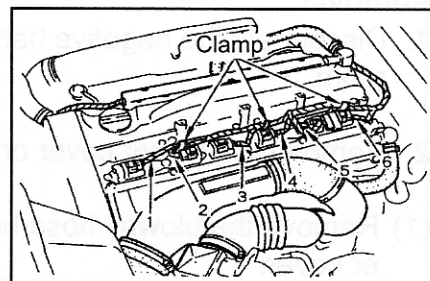

5. Install the power transistor unit to rocker cover ornament.

- Tighten rear right installation bolt to specified torque.
- Tightening torque (N-m{kg-m}) 2.3~3.0{0.23~0.31}

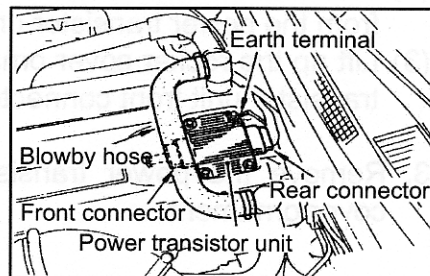

6. Install the rocker cover ornament.

- (1) Connect harness to the power transistor unit front side connector from reverse side.

- (2) Tighten the installation bolt.

Tightening torque (N-m{kg-m}) 2.3~3.0{0.23~0.31}

7. Tighten earth terminal using the power transistor unit rear right installation bolt.

Tightening torque (N-m{kg-m}) 2.3~3.0{0.23~0.31}

8. Install the rest in reverse order to the installation procedure.

RB20E ENGINE

8. TIMING BELT (RB20E)

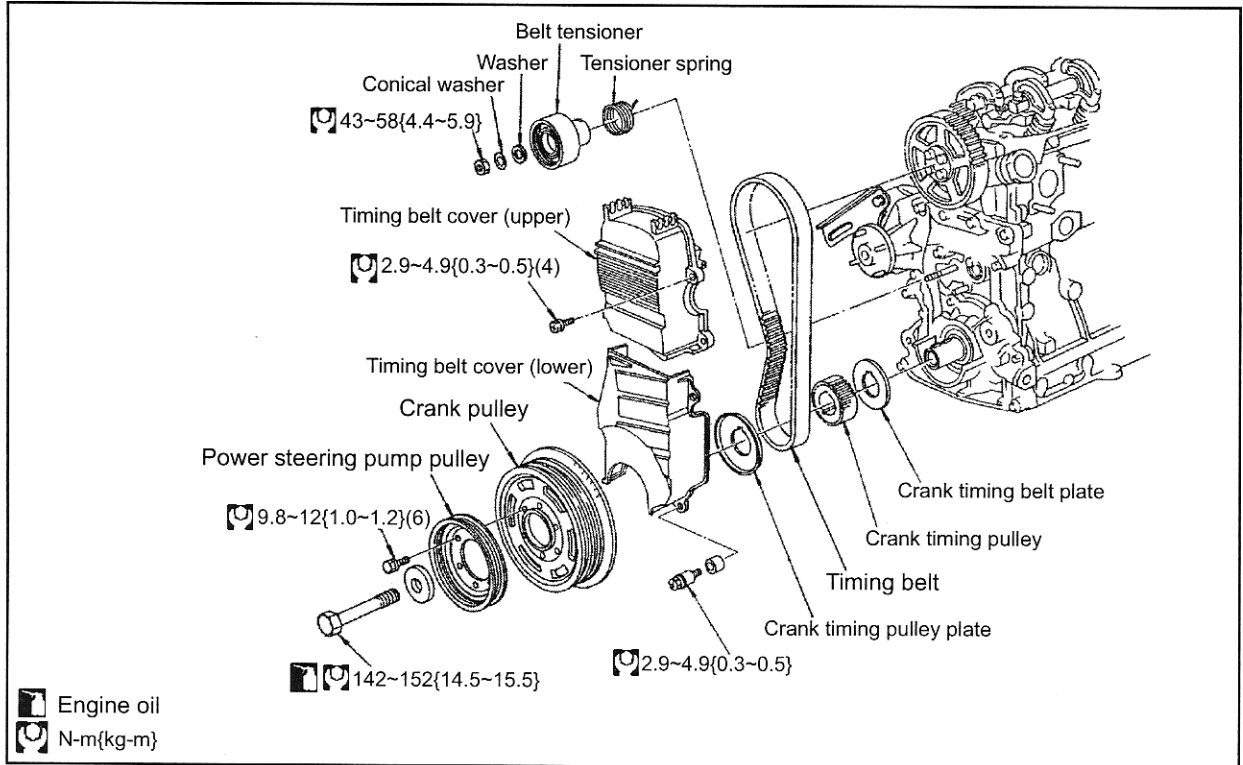

Replacement period: Every 100,000 km

Caution:

- Do not twist or bend the timing belt. Care must be taken not to allow grease or water to come in contact with the timing belt.
- Do not readjust (retension) the belt as it will shorten the life expectancy of the timing belt.
- It is recommended to replace the timing belt with a new one, once you have removed or loosened the timing belt during inspection or removal of other parts.

Removal

1. Remove a negative battery terminal.
 - (1) Open the boot lid.
 - (2) Remove the boot front finisher and disconnect negative battery terminal.
2. Remove the air cleaner and the air duct.
3. Remove the under cover.
4. Extract coolant from radiator drain plug.
5. Remove the cooling fan.
6. Remove the radiator.
7. Remove the supplement belt.
8. Remove the high-tension cord and the primary cord from the timing belt cover (upper).

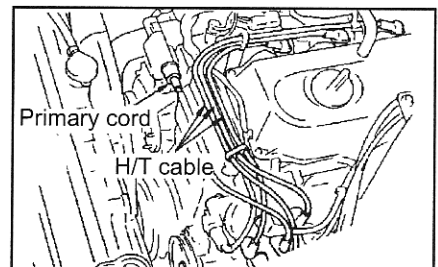

RB20E ENGINE

9. Remove the timing belt cover (upper).

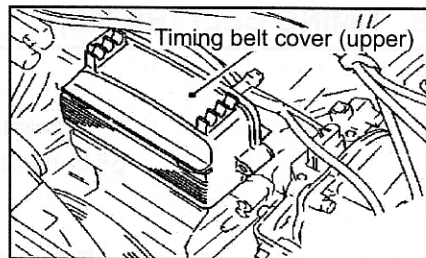

10. Remove the power steering pump pulley from the crank pulley.

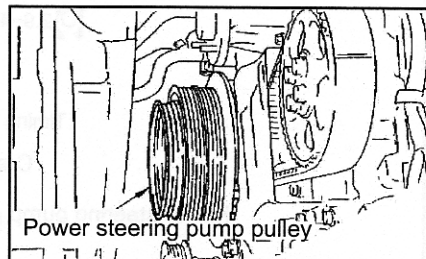

11. Position No. 1 cylinder at compression T.D.C (top dead centre).

- Turn the crank pulley clockwise and align belt cover timing indicator and the timing mark (0°).

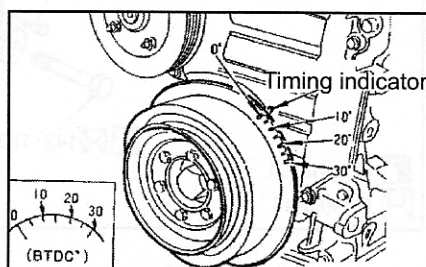

- At this time, the cam timing pulley alignment mark should be in the position shown in the diagram on right.
- If the cam timing pulley alignment is not at correct position, turn the crank pulley 360° clockwise.
- Place alignment mark on back side of the timing belt by aligning it to the cam timing pulley alignment mark.

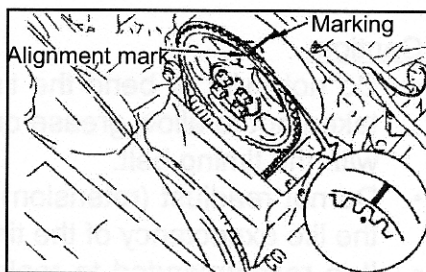

12. Remove the crank pulley.

- (1) Remove the starter motor.
- (2) Install the ring gear stopper to fix the drive plate.

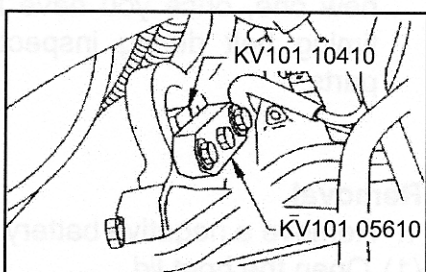

- (3) Loosen the crank pulley bolt and draw out approx. 1cm.
- (4) Install M6 x 1.0 with underhead approx. 40mm to crank pulley screw hole. Use the crank pulley to remove from the crankshaft.

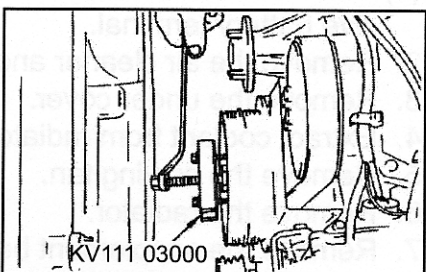

RB20E ENGINE

- 13. Remove the timing belt cover (lower).
- 14. Remove the crank timing pulley plate (front).
- 15. Place alignment mark on back side of the timing belt by aligning it to the crank timing pulley alignment mark.

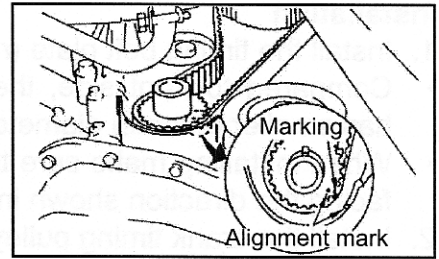

- 16. Remove the timing belt.
 - (1) Loosen the tension pulley installation nuts.
 - (2) Insert the wrench into tensioner pulley hexagonal hole and turn it to remove the timing belt.

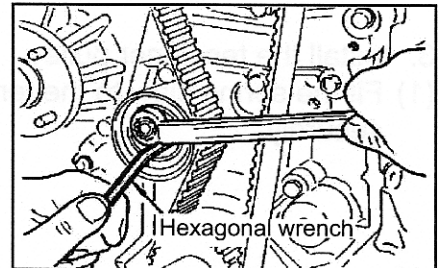

- 17. Remove the tensioner pulley.
- 18. Remove the crank timing pulley.
- 19. Remove the crank timing pulley plate (rear).

Inspection

- Refer to the diagram below to inspect the timing belt. Check for any wear or adhesion of foreign objects.
- Replace timing belt if inspection indicates any problem.

ITEM	CONDITION	CAUSE
Missing tooth Cracked tooth		Cam shaft lock
Cracks on rear side		Tensioner lock Engine overheat Interference with belt cover etc.
Wear and cracks on the side		Belt mis-alignment Belt plate malfunction
Worn teeth		Cam shaft rotation resistance
Grease or water adhesion	-	Oil seal malfunction Water pump leak

- Check each pulley tooth for any wear or cracks. Replace with new belt if any abnormality is found.

Installation

1. Install the timing belt plate (rear).
 - Compared to front side, the rear timing pulley plate has smaller external diameter.
 - When installing make sure the external diameter R is facing the direction shown in the diagram on the right.
2. Install the crank timing pulley.
 - Make sure the crankshaft key is facing the top.

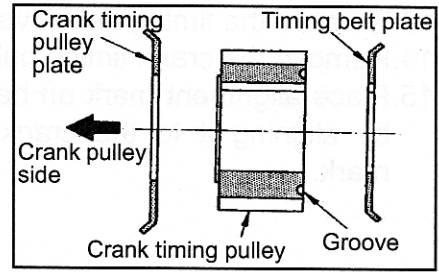

3. Install the tensioner pulley.
 - (1) Fit the spring claw to the tensioner pulley groove securely.
 - (2) Install it in a way so the tensioner pulley hexagonal hole and the spring claw is positioned as shown in the diagram on the right.

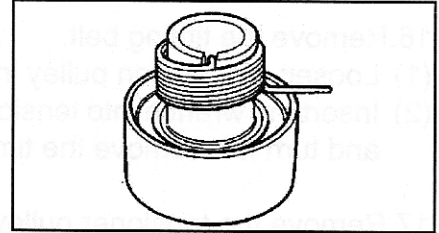

- (3) Hold the tensioner pulley with your finger. Hook the spring on top of the stud bolt by rotating the spring anti-clockwise.

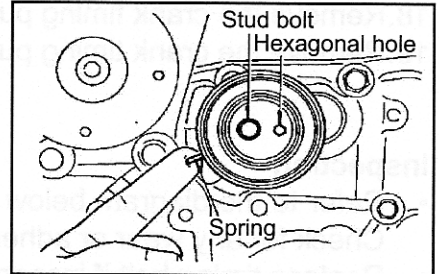

- (4) Temporarily install the tensioner pulley by installing in the order of washer, conical washer and installation nut.
 - Make sure the conical washer is facing the direction shown in the diagram on the right.

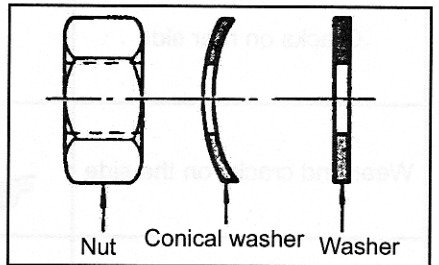
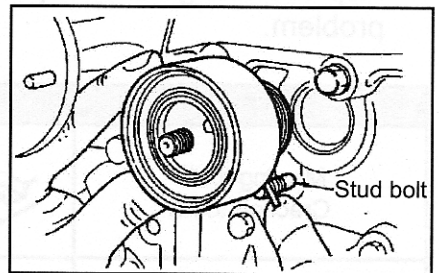

4. Install the timing belt.
 - (1) Check that the crank timing pulley key groove is facing up.
 - (2) Check that the cam timing pulley alignment mark is facing up.
 - (3) Insert wrench to the tensioner pulley hexagonal hole and turn it clockwise to temporarily tighten the installation nut to fix the tensioner pulley.
 - (4) Install the timing belt by aligning the crank timing pulley and cam timing pulley alignment mark to the timing belt reverse side alignment mark.
 - After installing make sure each pulley and the belt alignment mark is as shown in the diagram on the right.

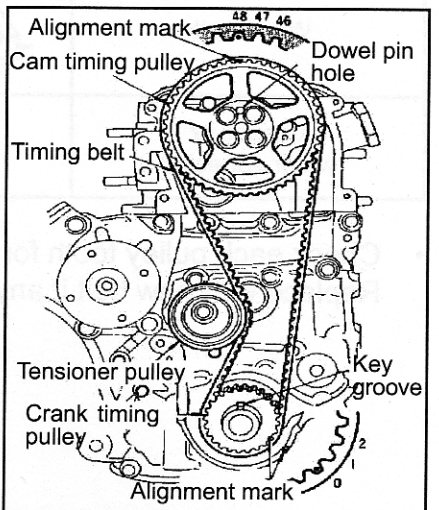

RB20E ENGINE

- (5) Loosen the tensioner pulley installation nut to tension the timing belt.
- Make sure the timing belt and the pulley is securely engaged at four locations as shown in the diagram on the right.

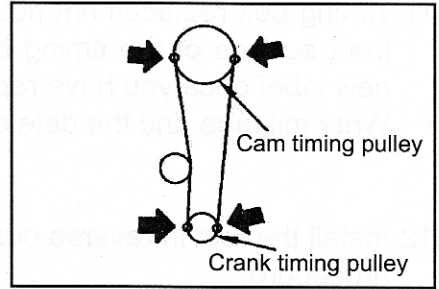

5. Adjust the timing belt tension.
- (1) Remove the spark plug.
 - (2) Remove the rocker cover.
 - (3) Loosen all rocker shaft installation bolts.
 - (4) Insert the wrench to tensioner pulley hexagonal hole and turn it anti-clockwise two to three turns to fit in the timing belt.
 - OR turn the crankshaft clockwise twice.

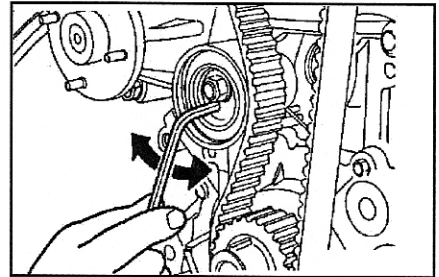

- (5) Insert wrench to tensioner pulley hexagonal hole to fix the tensioner pulley to tighten the installation nuts.
- Tightening torque (N-m{kg-m}) 43~58{4.4~5.9}

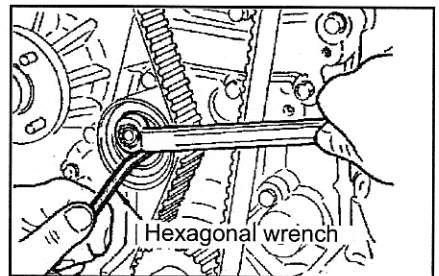

6. Install the crank timing pulley plate (front).
- Compared to rear side, the front timing pulley plate has bigger external diameter.
 - When installing make sure the external diameter R is facing the direction shown in the diagram on the right.

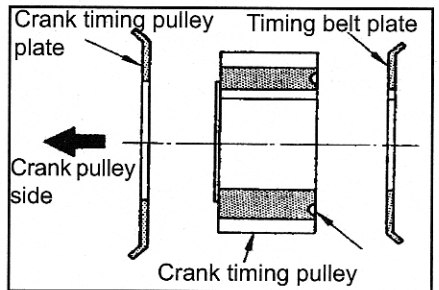

7. Install the timing belt cover (lower).
- Tightening torque (N-m{kg-m}) 2.9~4.9{0.3~0.5}
8. Install the timing belt cover (upper).
- Apply gasket to reverse side of the cover.
- Tightening torque (N-m{kg-m}) 2.9~4.9{0.3~0.5}

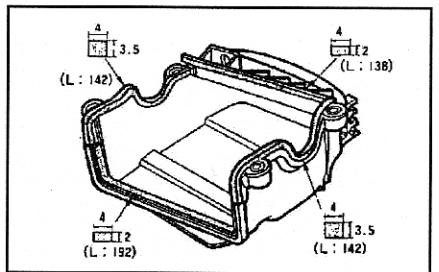

9. Install the crank pulley.
- Coat crank pulley bolt and the surface with engine oil.
 - Install the washer so the flat surface is facing the crank pulley.
- Tightening torque (N-m{kg-m}) 142~152{14.5~15.1}

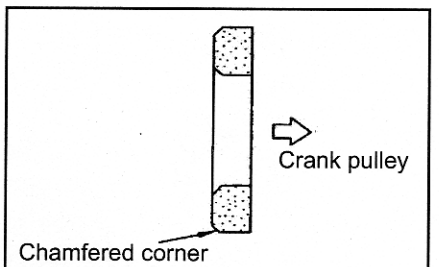

10. Install the power steering pump pulley.
- Tightening torque (N-m{kg-m}) 9.8~12{1.0~1.2}

RB20E ENGINE

- 11. Timing belt replacement notification label is placed in front surface of the timing belt cover (upper). Place new label once you have replaced the timing belt.
 - Write mileage and the date on the label.

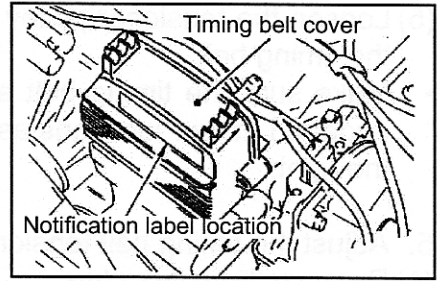

- 12. Install the rest in reverse order to the removal procedure.

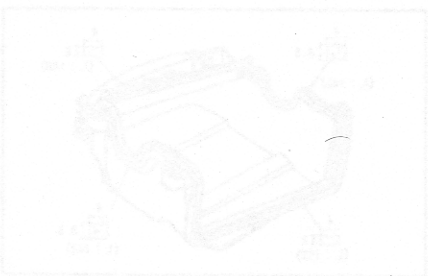
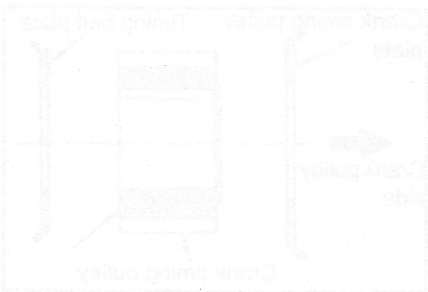
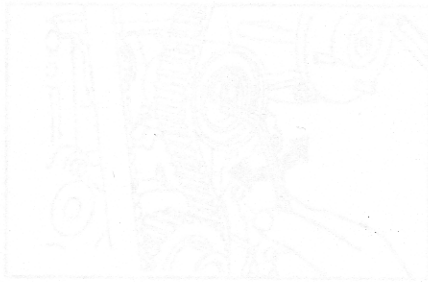

RB25DE / RB25DET ENGINE

8. TIMING BELT (RB25DE / RB25DET)

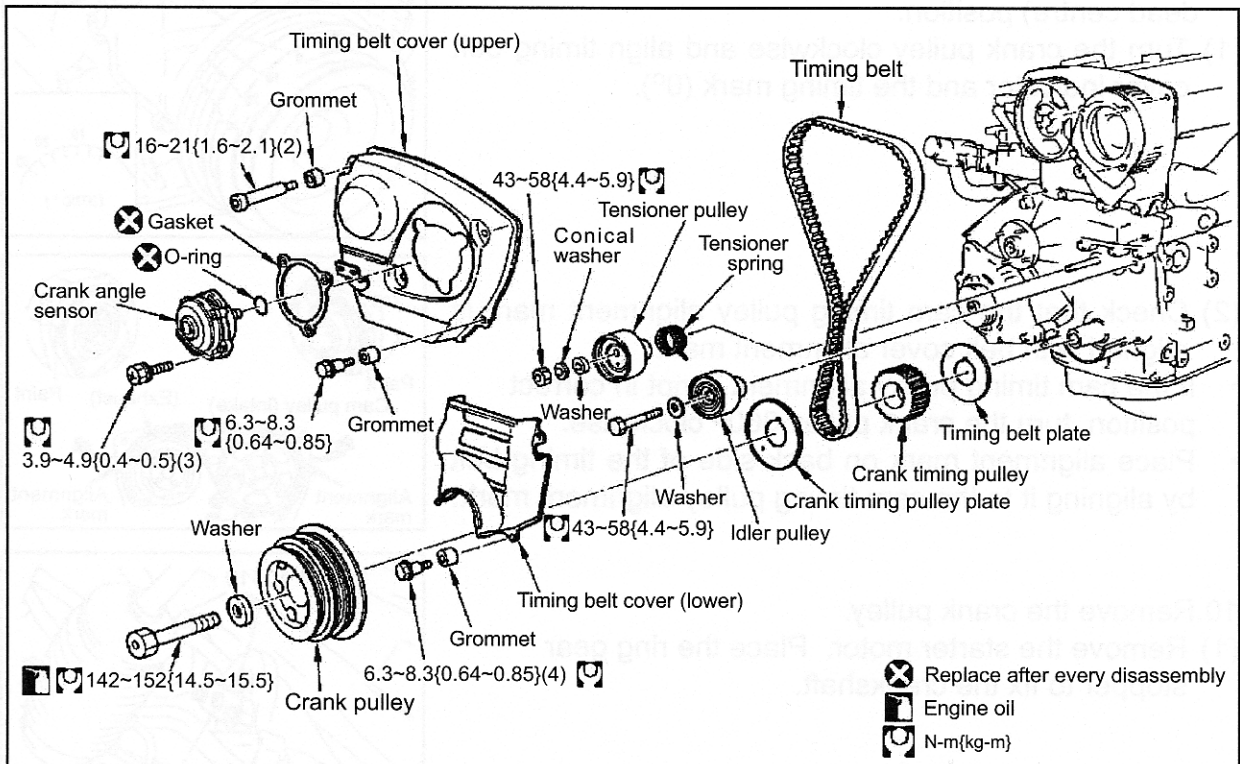

Caution:

- Do not twist or bend the timing belt. Care must be taken not to allow grease or water to come in contact with the timing belt.
- Do not readjust (retension) the belt as it will shorten the life expectancy of the timing belt.
- It is recommended to replace the timing belt with a new one, once you have removed or loosened the timing belt during inspection or removal of parts.

Removal

1. Remove the negative battery terminal.
 - (1) Open the boot lid.
 - (2) Remove the boot room front finisher and disconnect negative battery terminal.
2. Remove the under cover.
3. Extract coolant from radiator drain plug.
4. Remove the radiator.
5. Remove the cooling fan.
6. Remove the supplement belt.
7. Remove the crank angle sensor.
 - The crank angle sensor must be handled gently so it will not cause any damage.
8. Remove the timing belt cover (upper).

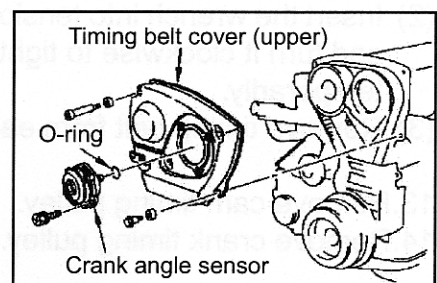

RB25DE / RB25DET ENGINE

9. Position No. 1 cylinder at compression T.D.C (top dead centre) position.

(1) Turn the crank pulley clockwise and align timing belt cover indicator and the timing mark (0°).

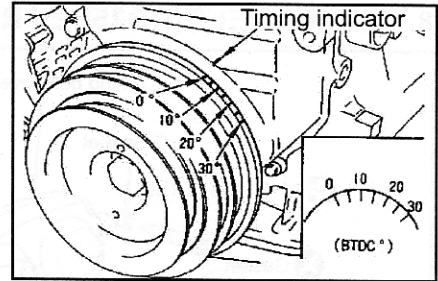

(2) Check that the cam timing pulley alignment mark is aligned with belt cover alignment mark.

- If the cam timing pulley alignment is not in correct position, turn the crank pulley 360° clockwise.
- Place alignment mark on back side of the timing belt by aligning it to the cam timing pulley alignment mark.

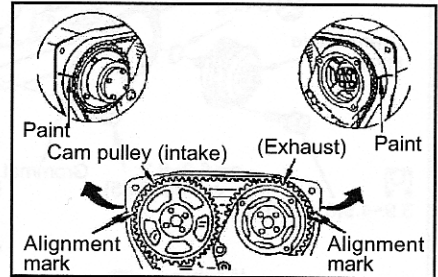

10. Remove the crank pulley.

(1) Remove the starter motor. Place the ring gear stopper to fix the crankshaft.

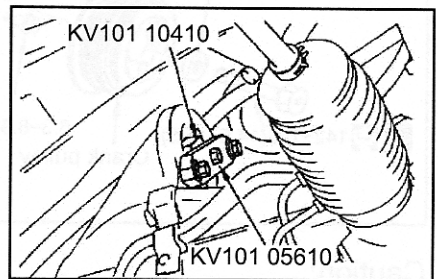

(2) Loosen the crank pulley bolt and draw out approx. 1cm.

- Install M6 x 1.0 (2) with underhead approx. 50mm to crank pulley screw holes. Use the pulley puller to remove the crank pulley from the crankshaft.

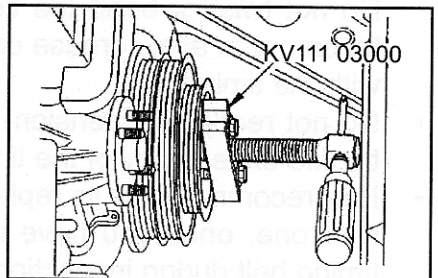

11. Remove the timing belt cover (lower).

- Remove the crank timing pulley plate.
- Place alignment mark on back side of the timing belt by aligning it to the crank timing pulley alignment mark.

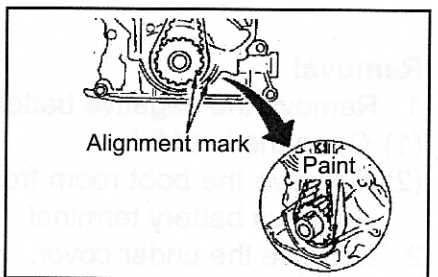

12. Remove the timing belt.

- (1) Loosen the tension pulley installation nuts.
- (2) Insert the wrench into tensioner pulley hexagonal hole and turn it clockwise to tighten the installation nut temporarily.
- (3) Remove timing belt from each pulley.

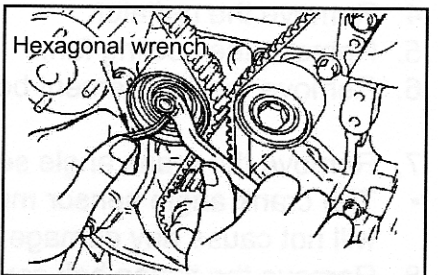

13. Remove cam timing pulley.



14. Remove crank timing pulley.

- 15. Remove the timing belt plate.
- 16. Remove the tensioner pulley and the spring.
- 17. Remove the idler pulley.

Inspection

Timing belt

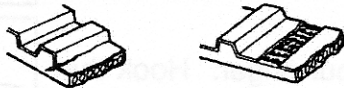
- Refer to the diagram below to inspect the timing belt. Check for any wear or adhesion of foreign objects.
- Replace timing belt if inspection indicates any problem.

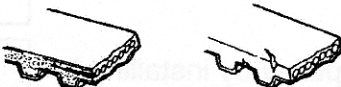
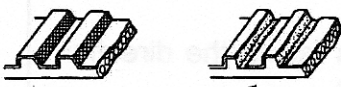
ITEM	CONDITION	CAUSE
Missing tooth Cracked tooth		Cam shaft lock
Cracks on rear side		Tensioner lock Engine overheat Interference with belt cover etc.
Wear and cracks on the side		Belt mis-alignment Belt plate malfunction
Worn teeth		Cam shaft rotation resistance
Grease or water adhesion	-	Oil seal malfunction Water pump leak

- Check each pulley tooth for any wear or cracks. Replace with new belt if any abnormality is found.

Timing belt cover gasket

- Check if there is any wear or damage to timing belt cover (upper and lower) reverse side dried liquid packing.
- Replace the cover ASSY if there is any fault or abnormal.

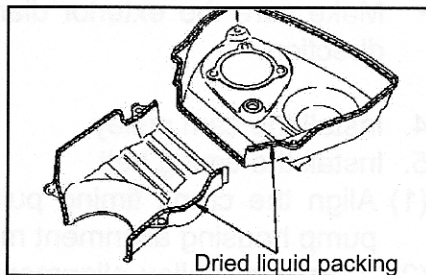

Installation

1. Install idler pulley.
Tightening torque (N-m{kg-m}) 43~58{4.4~5.9}

 - After tightening with correct torque, make sure the idler pulley will turn smoothly.

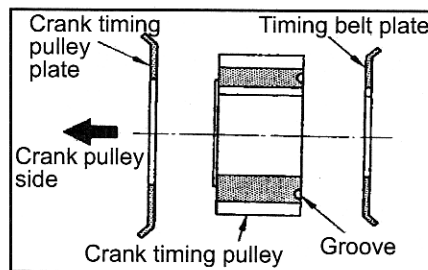

2. Install the tensioner pulley.
 - (1) Fit the tensioner spring claw to the tensioner pulley groove securely.

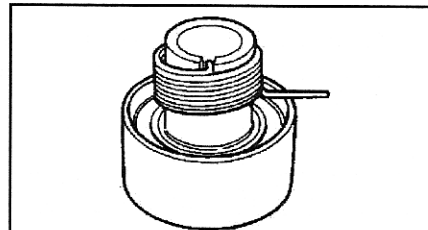

- (2) Hold the tensioner pulley with your finger. Hook the spring on top of the stud bolt by rotating the spring anti-clockwise.

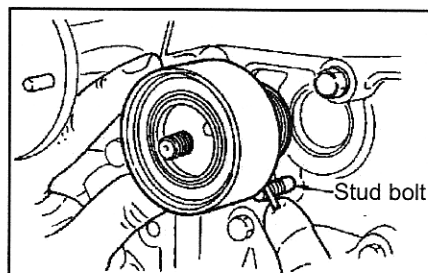

- (3) Temporarily install the tensioner pulley by installing in the order of washer, conical washer and installation nut.
 - Make sure the conical washer is facing the direction shown in the diagram on the right.

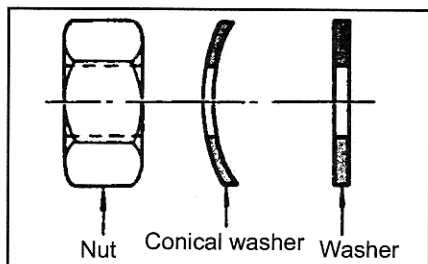

3. Install the timing belt plate (rear) and the crank timing pulley.
 - Crankshaft key must be facing up.
 - Rear timing belt plate has smaller exterior diameter compared to the front timing belt plate.
 - Make sure the exterior diameter 'R' is facing correct direction.

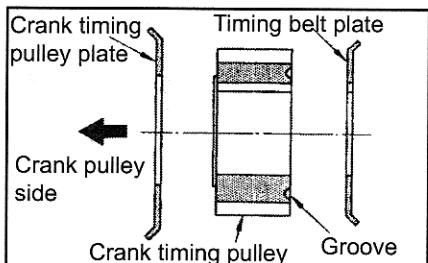

4. Install the cam pulley.
5. Install the timing belt.
 - (1) Align the crank timing pulley alignment mark to oil pump housing alignment mark (No. 1 cylinder T.D.C).
 - (2) Align cam pulley alignment mark to each belt cover alignment mark. (No. 1 cylinder T.D.C).
 - (3) Insert the wrench to tensioner pulley hexagonal hole and turn it clockwise to temporarily tighten the installation nut.
 - (4) Align timing belt and each pulley alignment mark to install the timing belt.
 - Make sure each timing pulley and timing belt alignment mark is at position shown in the diagram.

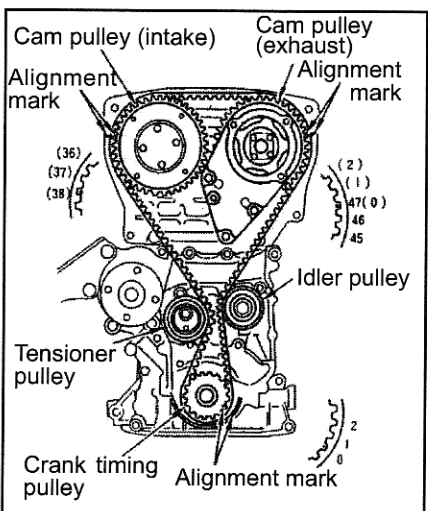

RB25DE / RB25DET ENGINE

6. Adjust the timing belt tension.

- (1) Turn the crankshaft clockwise twice with tensioner pulley installation bolt in loose condition.
 - (2) Insert wrench to tensioner pulley hexagonal hole to fix the tensioner pulley to tighten the installation bolts.
Tightening torque(N-m{kg-m}) 43~58{4.4~5.9}
- The timing belt tension should be at correct tension.

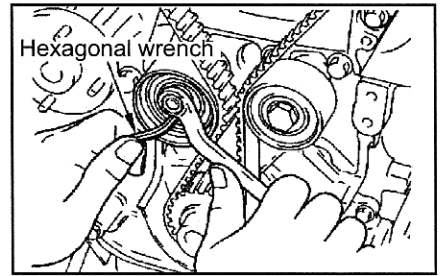

7. Install the crank timing pulley plate.

8. Install the timing belt cover (lower).

Tightening torque (N-m{kg-m}) 6.4~8.4{0.65~0.86}

9. Install the crank pulley.

- Fix the crankshaft using the ring gear stopper.
- Install the washer so the flat surface is facing the crank pulley.
- Coat installation bolt and flange surface then tighten the bolts.

Tightening torque (N-m{kg-m}) 142~152{14.5~15.5}

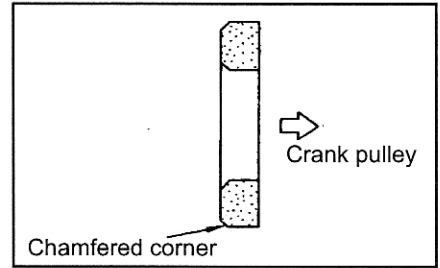

10. Install the timing belt cover (upper)

Tightening torque (N-m{kg-m})

Inner hexagonal installation bolt 16~21{1.6~2.1}

Installation bolt 6.4~8.4{0.65~0.86}

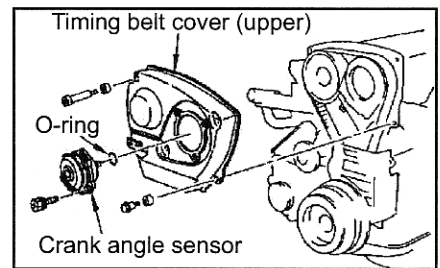

11. Install the crank angle sensor.

- (1) Apply grease to spline parts.

Caution:

Do not use chassis grease as it will outflow in high temperature.

- (2) There is a fitting joint inside the spline. Check the position of the spline before installing.
- (3) Check if it can be inserted in to the crank angle sensor belt cover hole easily, then tighten the bolt.
- (4) If it doesn't move easily, loosen the belt cover installation bolt while the crank angle sensor is in inserted position. Lightly move the belt cover up, down, right and left to align the centre of the belt cover hole and the cam shaft centre. Tighten the bolts.

Tightening torque (N-m{kg-m}) 3.9~4.9{0.4~0.5}

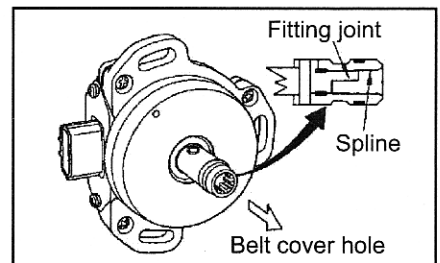

12. Place new timing belt replacement notification label on the timing belt cover surface (upper) once you have replaced the timing belt.

- Write mileage and the date on the label.

13. Install the rest in reverse order to the removal procedure.

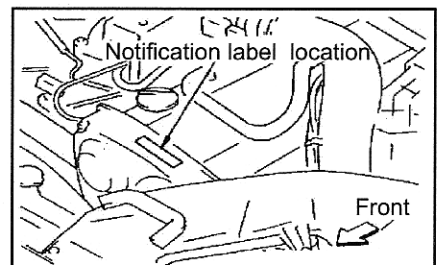

RB26DETT ENGINE

8. TIMING BELT (RB26DETT)

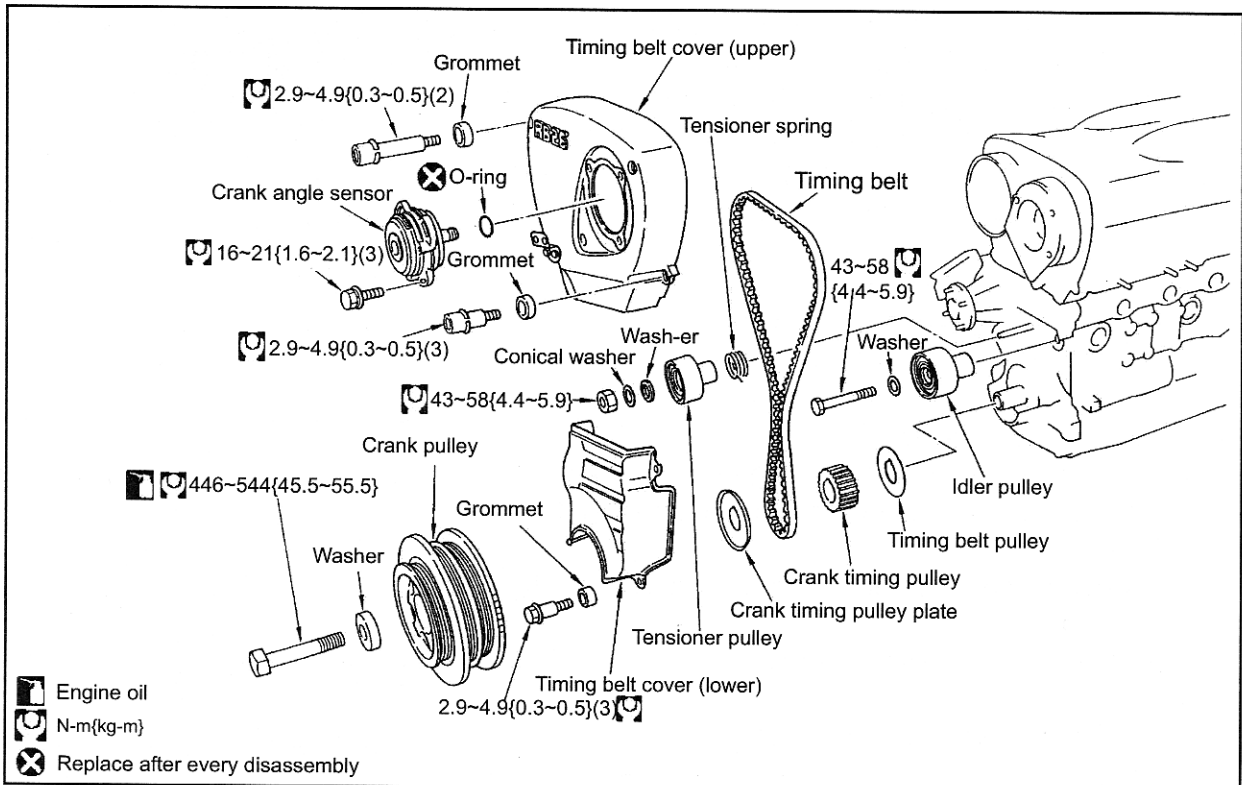

Caution:

- Do not twist or bend the timing belt. Care must be taken not to allow grease or water to come in contact with the timing belt.
- Do not readjust (retension) the belt as it will shorten the life expectancy of the timing belt.
- It is recommended to replace the timing belt with a new ones, once you have removed or loosened the timing belt during inspection or removal of parts.

Removal

1. Remove the negative battery terminal inside the boot.
2. Remove the front spoiler under cover.
3. Remove the under cover.
4. Extract coolant from radiator drain plug.
5. Remove the radiator.
6. Remove the cooling fan.
7. Remove the supplement belt.
8. Remove the crank angle sensor.
 - The crank angle sensor must be handled gently so it will not cause any damage.
9. Remove the timing belt cover (upper).

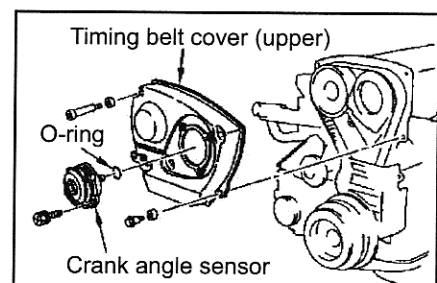

RB26DETT ENGINE

10. Position No. 1 cylinder at compression T.D.C (top dead centre) position.

- (1) Turn the crank pulley clockwise and align timing belt cover indicator and the timing mark (0°).

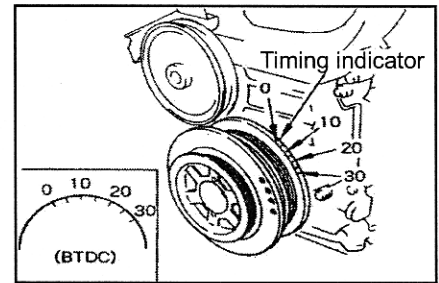

- (2) Check that the cam timing pulley alignment mark is aligned with belt cover alignment mark.

- If the cam timing pulley alignment is not at correct position, turn the crank pulley 360° clockwise.
- Place alignment mark on back side of the timing belt by aligning it to the cam timing pulley alignment mark.

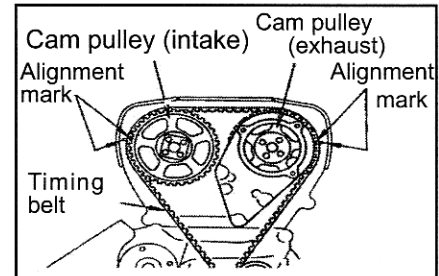

11. Remove the crank pulley.

- (1) Remove the starter motor.
- (2) Place the ring gear stopper to fix the crankshaft.

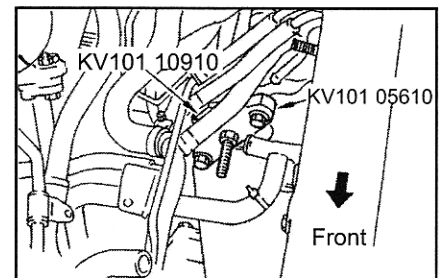

- (3) Loosen the crank pulley bolt and draw out approx. 1cm.

- Install M6 x 1.0 (2) with underhead approx. 50mm to crank pulley bolt holes. Use the pulley puller to remove the crank pulley from the crankshaft.

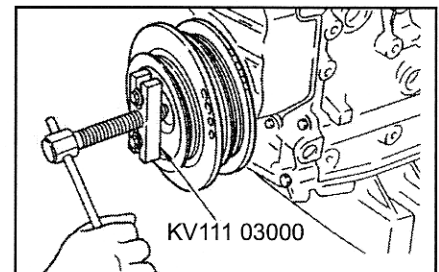

12. Remove the timing belt cover (lower).

13. Remove the crank timing pulley plate.

14. Place alignment mark on back side of the timing belt by aligning it to the crank timing pulley alignment mark.

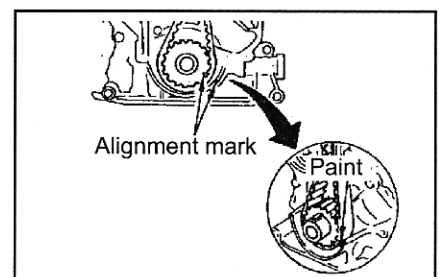

15. Remove the timing belt.

- (1) Loosen the tension pulley installation nuts.
- (2) Insert the wrench into tensioner pulley hexagonal hole and turn it clockwise to tighten the installation nut temporarily.
- (3) Remove the timing belt from each pulley.

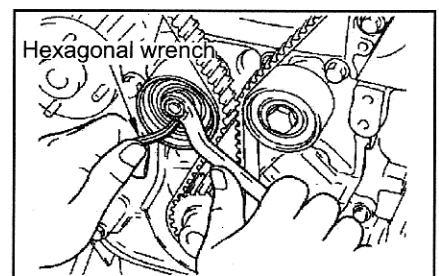

16. Remove the cam timing pulley.

17. Remove the crank timing pulley.

18. Remove the timing belt plate.





19. Remove the tensioner pulley and the spring.

20. Remove the idler pulley.

Inspection

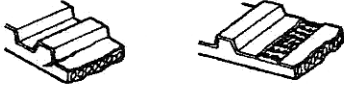
Timing belt

- Refer to the diagram below to inspect the timing belt. Check for any wear or adhesion of foreign objects.
- Replace timing belt if inspection indicates any problem.

ITEM	CONDITION	CAUSE
Missing tooth Cracked tooth		Cam shaft lock
Cracks on rear side		Tensioner lock Engine overheat Interference with belt cover etc.
Wear and cracks on the side		Belt mis-alignment Belt plate malfunction
Worn teeth		Cam shaft rotation resistance
Grease or water adhesion	-	Oil seal malfunction Water pump leak

- Check each pulley tooth for any wear or cracks. Replace with new belt if any abnormality is found.

Timing belt cover gasket

- Check if there is any wear or damage to timing belt cover (upper and lower) reverse side dried liquid packing.
- Replace the cover ASSY if there is any fault or abnormal.

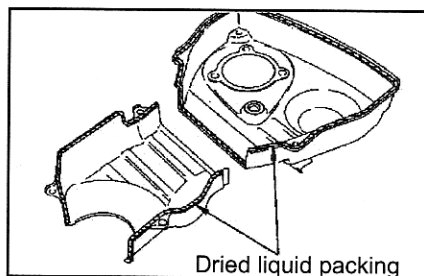

Installation

1. Install idler pulley.
Tightening torque (N-m{kg-m}) 43~58{4.4~5.9}
- After tightening with correct torque, make sure the idler pulley will turn smoothly.

2. Install the tensioner pulley.
 - (1) Fit the tensioner spring claw to the tensioner pulley groove securely.

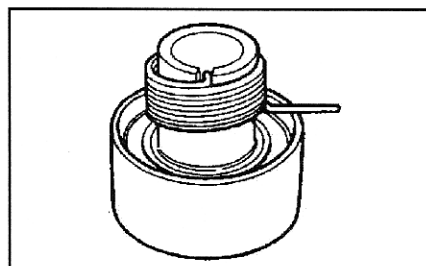

- (2) Hold the tensioner pulley with your finger. Hook the spring on top of the stud bolt by rotating the spring anti-clockwise.

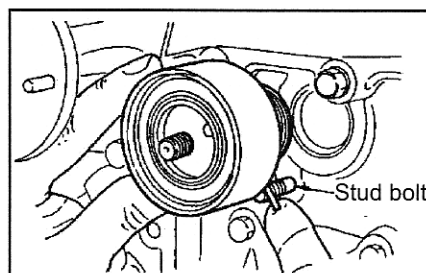

- (3) Temporarily install the tensioner pulley by installing in the order of washer, conical washer and installation nut.
 - Make sure the conical washer is facing the direction shown in the diagram on the right.

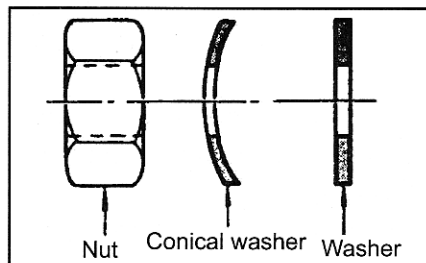

3. Install the timing belt plate (rear) and the crank timing pulley.
 - Crankshaft key must be facing up.
 - Rear timing belt plate has smaller exterior diameter compared to the front timing belt plate.
 - Make sure the exterior diameter 'R' is facing correct direction.

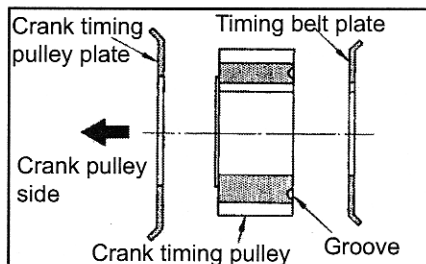

4. Install the cam pulley.
5. Install the timing belt.
 - (1) Align the crank timing pulley alignment mark to oil pump housing alignment mark (No. 1 cylinder T.D.C).
 - (2) Align cam pulley alignment mark to each belt cover alignment mark. (No. 1 cylinder T.D.C).
 - (3) Insert the wrench to tensioner pulley hexagonal hole and turn it clockwise to temporarily tighten the installation nut.
 - (4) Align timing belt and each pulley alignment mark to install the timing belt.
 - Make sure each timing pulley and timing belt alignment mark is at position shown in the diagram.

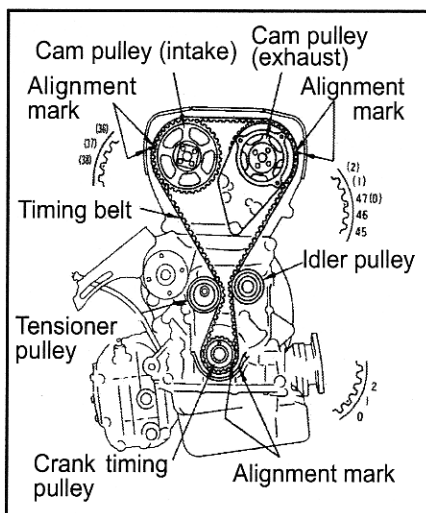

RB26DETT ENGINE

6. Adjust the timing belt tension.

- (1) Remove all spark plugs.
 - (2) Turn the crankshaft clockwise twice with tensioner pulley installation bolt in loose condition.
 - (3) Insert wrench to tensioner pulley hexagonal hole to fix the tensioner pulley to tighten the installation bolts.
Tightening torque(N-m{kg-m}) 43~58{4.4~5.9}
- The timing belt tension should be at correct tension.

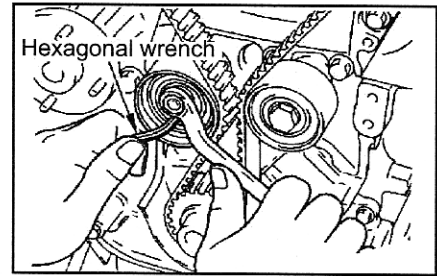

7. Install the crank timing pulley plate.

8. Install the timing belt cover (lower).
Tightening torque (N-m{kg-m}) 6.4~8.4{0.65~0.86}

9. Install the crank pulley.

- Fix the crankshaft using the ring gear stopper.
- Install the washer so the flat surface is facing the crank pulley.
- Coat installation bolt and flange surface then tighten the bolts.
Tightening torque (N-m{kg-m}) 142~152{14.5~15.5}

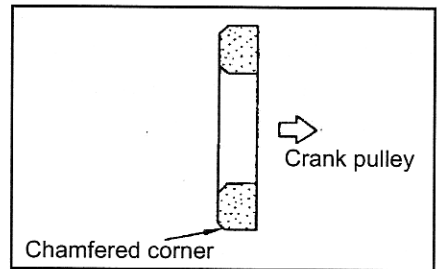

10. Install the timing belt cover (upper).

- Tightening torque (N-m{kg-m}) 2.9~4.9{0.3~0.5}

11. Install the crank angle sensor.

- (1) Apply grease to spline parts.

Caution:

Do not use chassis grease as it will outflow in high temperature.

- (2) There is a fitting joint inside the spline. Check the position of the spline before installing.
- (3) Check if it can be inserted in to the crank angle sensor belt cover hole easily, then tighten the bolt.
- (4) If it doesn't move easily, loosen the belt cover installation bolt while the crank angle sensor is in inserted position. Lightly move the belt cover up, down, right and left to align the centre of the belt cover hole and the cam shaft centre. Tighten the bolts.
Tightening torque (N-m{kg-m}) 3.9~4.9{0.4~0.5}

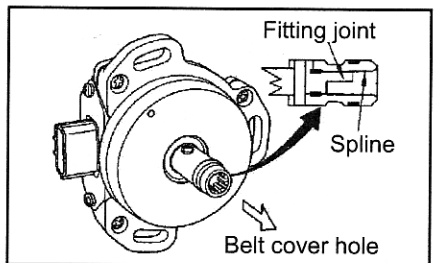
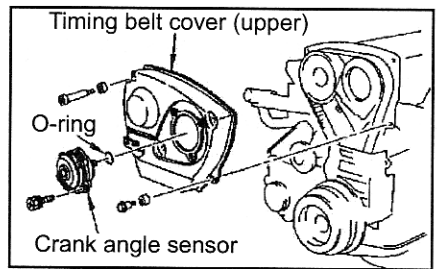

12. Place new timing belt replacement notification label once you have replaced the timing belt.

- Write mileage and the date on the label.

13. Install the rest in reverse order to the removal procedure.

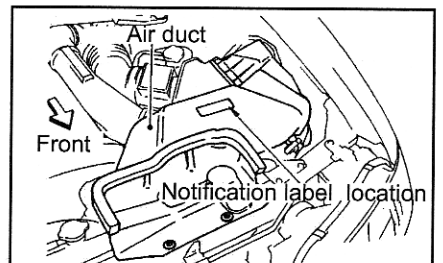

RB20E / RB25DE / RB25DET / RB26DETT ENGINE

9. ENGINE OIL

Engine oil replacement period

ENGINE	OIL TYPE	REPLACEMENT PERIOD
RB20E, RB25DE	SE, SF, SG	15,000 km or every year
RB25DET	SG	10,000 km or every year
	SE, SF	5,000 km or every 6 months
RB26DETT	SE, SF, SG	5,000 km or every 6 months

ITEM		ENGINE	RB25E / RB25DE	RB20E	RB26DETT	
					STD	N1
Oil tank capacity (L)		H level	4.0	4.1	4.5	5.8
		L level	3.0	3.3	3.5	4.8
Oil replacement amount (L)	Replacing oil only	Extracted from drain plug	Approx. 3.8	Approx. 3.9	Approx. 4.2	Approx. 4.8
		Extracted using oil changer	Approx. 4.0	Approx. 4.1	-	-
	Replacing oil and filter	Extracted from drain plug	Approx. 4.2	Approx. 4.3	Approx. 4.6	Approx. 5.2
		Extracted using oil changer	Approx. 4.4	Approx. 4.5	-	-

Oil pressure inspection

- Check engine oil level.
- Remove oil pressure switch.
- Connect oil pressure gauge
- Check if there is adequate oil pressure for engine rev after warming up the engine.

ENGINE REV		Idling	2000	6000
Discharge pressure (MPa {kg/cm ² } / rpm)	RB20E	0.1{1.0}	0.37{3.8}	0.47{4.8}
	RB25DE	0.1{1.0}	0.32{3.3}	0.52{5.3}
	RB25DET	0.11{1.1}	0.34{3.5}	0.55{5.6}
	RB26DETT	0.15{1.5}	0.30{3.0}	0.46{4.6}

(RB20E / RB25DE)

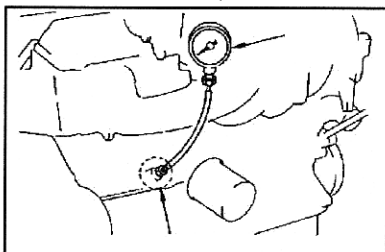

(RB25DET)

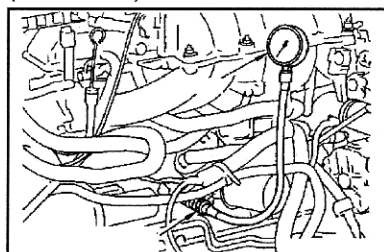

(RB26DETT)

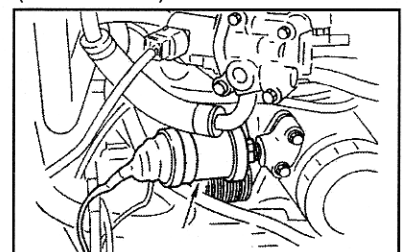

10. OIL FILTER

Oil filter replacement period

(When SE, SF or SG oil is used)

ENGINE	REPLACEMENT PERIOD
RB20E / RB25DE	15,000 km or every year
RB25DET	10,000 km or every year
RB26DETT	10,000 km or every year

Removal

Use oil filter wrench to remove the oil filter.

Caution:

Catch dripping waste oil when removing the oil filter.

Installation

1. Wipe off any dirt or dust from surface area of the cylinder block (oil filter bracket: RB25DET / RB26DETT) and coat the new filter oil seal area with engine oil.
2. Insert the oil filter and turn it 2/3 of a turn until it touches the cylinder block (oil filter bracket: RB25DET / RB26DETT).

Tightening torque (N-m{kg-m}) 15~21{1.5~2.1}

Caution:

Check to make sure there are no oil leaks after starting the engine.

(RB25DET)

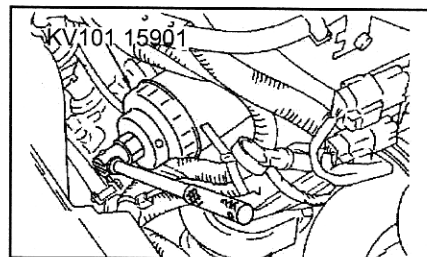

(RB26DETT)

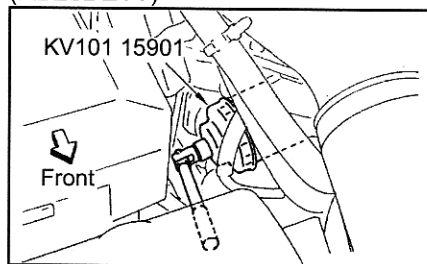

(RB26DETT)

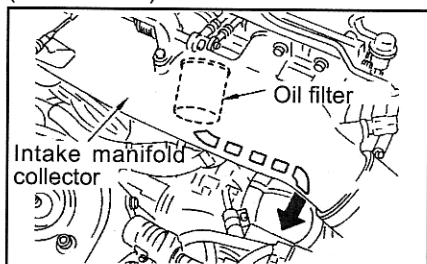

4 - 8 FUEL FILTER

Replacement period: Every 100,000 km

Removal

1. Release the fuel pressure.
2. Loosen the hose clamp and remove the fuel hose (RB20E / RB25DE / RB25DET), fuel feed and return hose (RB26DETT) from the filter.
3. Remove the fuel filter from the bracket.

Installation

- Carry out the removal procedures in reverse order noting the following points below:
 - Make sure to tighten the hose clamp.
 - Make sure there are no fuel leaking when the ignition is turned to ON position.
 - When installing the fuel filter, make sure the flange is touching the holder upper end.

(RB20E / RB25DE / RB25DET)

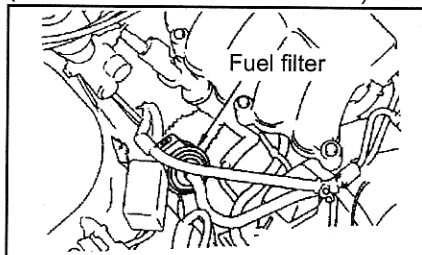

(RB26DETT)

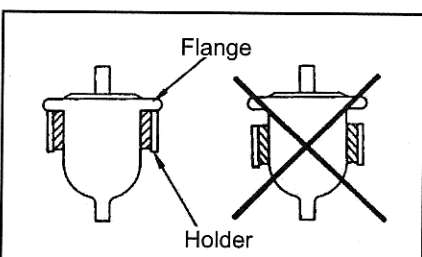
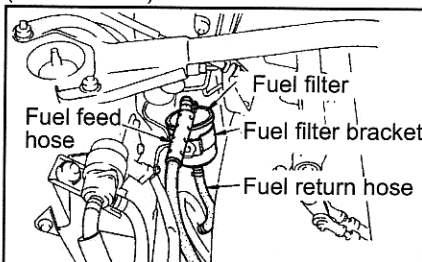

11. COOLANT

Replacement period: Every 2 years

Extracting coolant

1. Place the ignition switch to ON position and set the vehicle temperature to 32°C using the heater control temperature adjustment knob.
2. Remove the under cover (RB20E / RB25DE / RB25DET).
3. Remove the radiator drain plug and remove the radiator cap to extract the coolant.
4. Remove the exhaust front tube (RB26DETT).
5. Remove the drain plug on the left side of the cylinder block to extract the coolant inside the cylinder block.
6. Remove the reservoir tank and discharge coolant.

(RB20E / RB25DE / RB25DET)

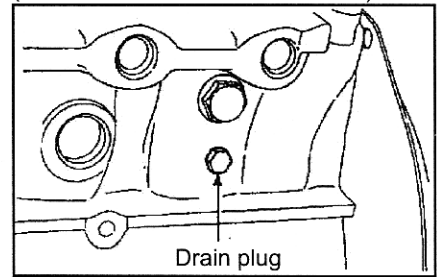

(RB26DETT)

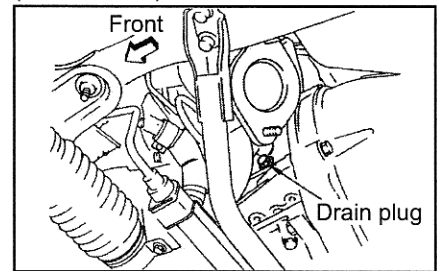

Filling up coolant

1. Install the reservoir tank.
2. Install the radiator drain plug and the cylinder drain plug.
 - Coat thread part of the cylinder block drain plug with sealing agent (Three bond 1386B)
3. Check each clamp to make sure it is tightened securely.
4. Place the ignition switch to ON position and set the vehicle temperature to 32°C using the heater control temperature adjustment knob.
5. Remove air release plug located at front side of the intake manifold collector.

(RB25DE)

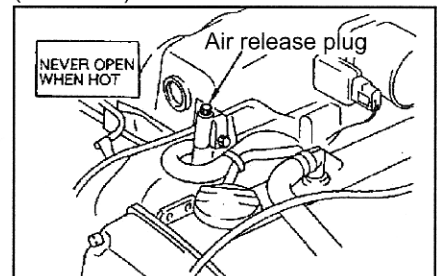

(RB26DETT)

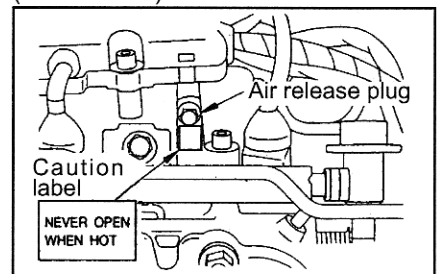

Note:

The bolt with copper washer is the air release plug. There is a caution label located near the air release plug.

6. Top up the radiator with coolant at filling speed of less than 2L / min. Close the plug if the coolant start spouting out from the air release plug while filling up the radiator. Top up coolant to the top.
 - Replace air release plug copper washer with a new one.
7. Close the radiator cap and start the engine. Keep idling until the thermostat injection valve opens.
8. Check that the engine coolant temperature gauge needle is pointing over mid way. Touch the radiator lower hose and make sure warm water is flowing.
9. After checking the thermostat injection valve, race the engine 2 to 3 times with 10 seconds interval between each at 2500rpm.

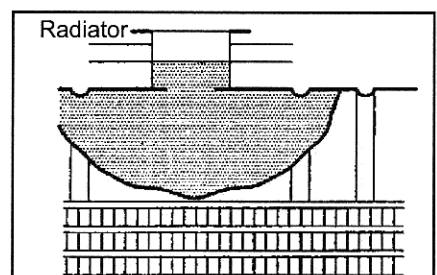

Caution:

Do not raise the engine coolant temperature too high.

RB20E / RB25DE / RB25DET / RB26DETT ENGINE

10. Stop the engine.
11. After cooling down the engine, open the radiator cap and check the level of coolant. If the coolant level has decreased repeat the steps from 7.
12. Once the coolant level has stabilised top up the coolant to the MAX line.
13. Refill the coolant to the filler tube. Place the radiator cap and stop the engine.
14. After cooling down the engine, refill the reservoir tank with coolant to the MAX line.
15. Restart the engine and increase the engine speed to 3000rpm from idling position. At this time make sure there is no heater core water flowing sound from the instrument panel area. If there is a water flowing sound, repeat steps 7 to 14 until the coolant level stabilises.

Reference: LLC density.

Standard	LLC 30%
Cold climate area	LLC 50%

EN3 ENGINE MECHANICAL (RB20E)

1. AIR CLEANER & AIR DUCT

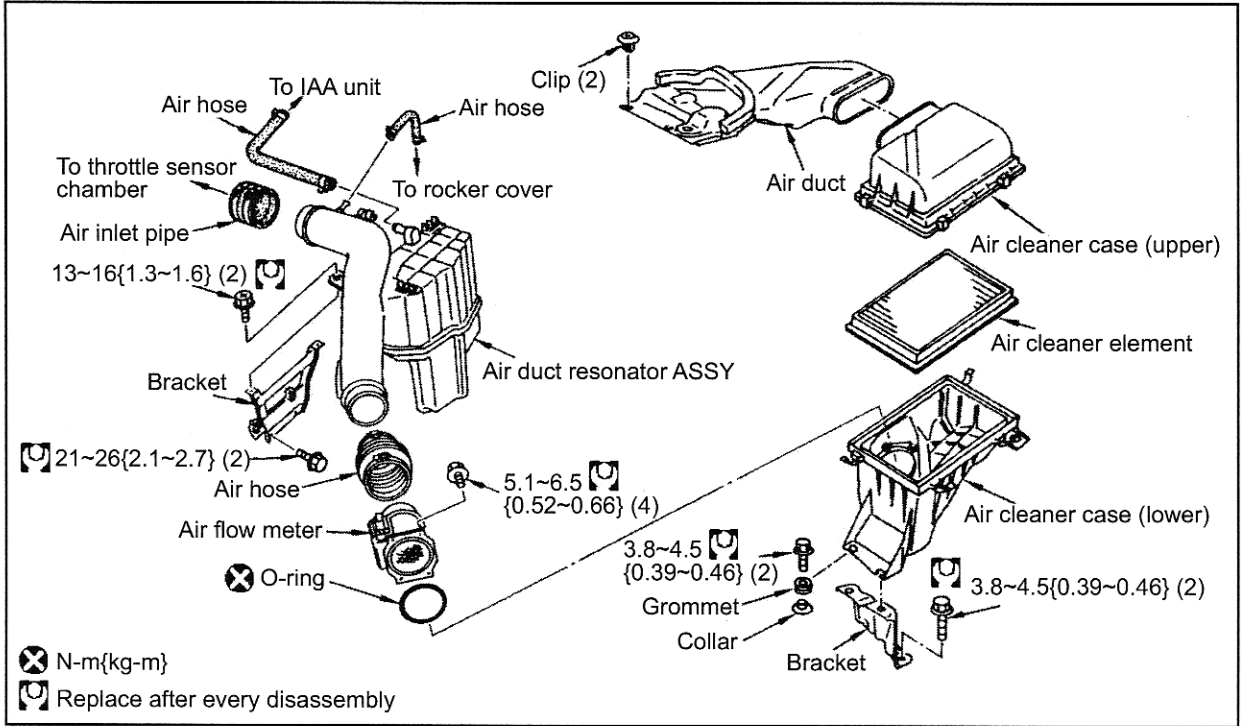

Removal

1. Remove negative battery terminal.
 - (1) Open the boot lid.
 - (2) Remove the boot front finisher and remove the negative battery terminal.
2. Before removing, use air gun to remove any rubbish, dust etc. to avoid foreign objects entering the duct.
3. Remove the air flow meter connector.
4. Remove the air duct, air cleaner case (upper) and air cleaner element.
 - Remove 2 air duct clips and 4 air cleaner case (upper) clips.
5. Remove the air cleaner case (lower).
 - Remove the installation bolts.
6. Remove the air duct, resonator ASSY.
 - Remove 2 air hoses, and installation bolts.

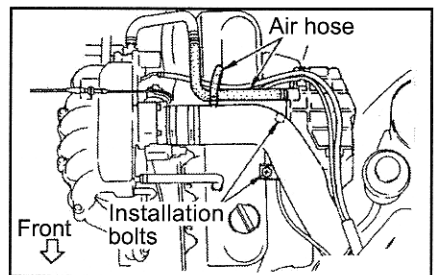
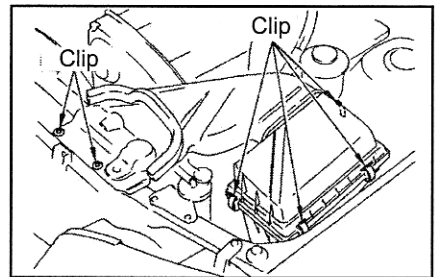
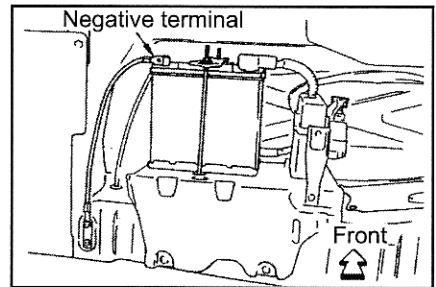

Inspection

- Make sure the cleaner element is not dirty.
 Inspection period: Every 60,000 km

Installation

1. Install the air duct and resonator ASSY.
 - Tighten installation bolts (2).
Tightening torque (N-m{kg-m}) 16~21{1.6~2.1}
 - Install the air hose (2).

2. Install the air cleaner case (lower).
Tightening torque (N-m{kg-m}) 5.1~6.5{0.52~0.66}
3. Install the air cleaner element, air cleaner case (upper) and the air duct.
 - Install 4 clips on the air cleaner case (upper) and 2 clips on the air duct clips.

4. Install the rest in reverse order to the removal procedure.

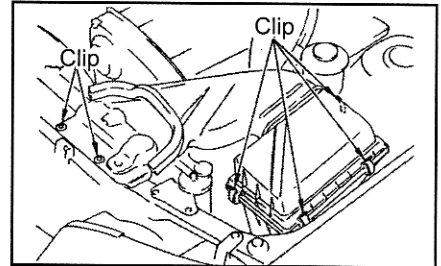
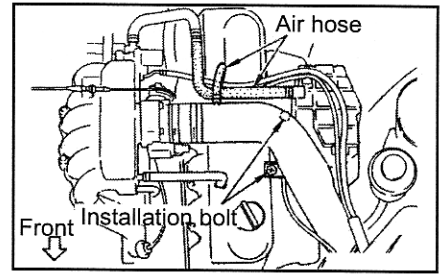

2. INTAKE MANIFOLD COLLECTOR

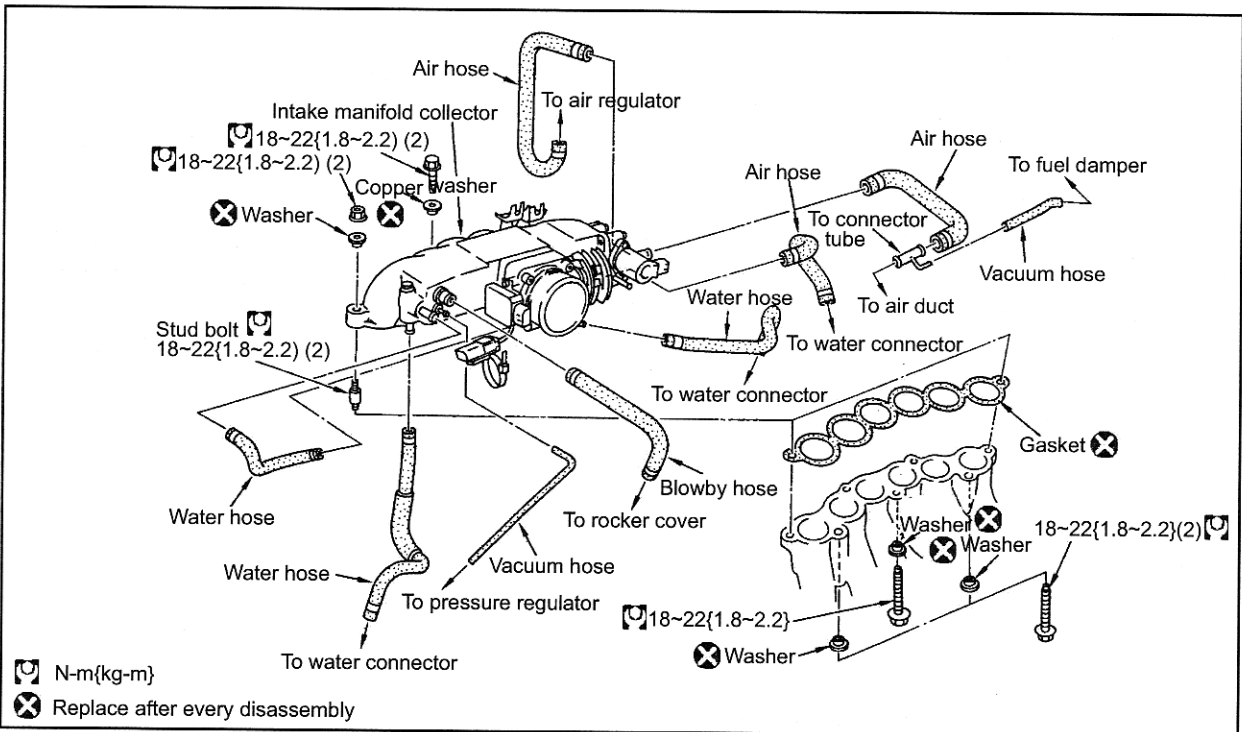

Removal

1. Remove the negative battery terminal.
 - (1) Open the boot lid.
 - (2) Remove the boot front finisher and remove the negative battery terminal.
2. Drain coolant from the radiator drain plug.
3. Remove the air duct and the resonator ASSY.
4. Remove the acceleration wire and the ASCD wire from the throttle drum.

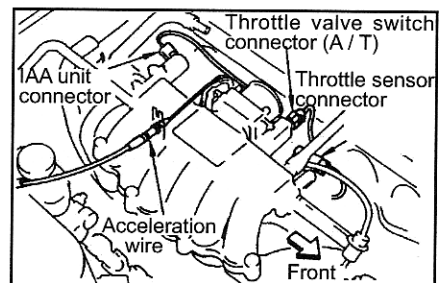

RB20E ENGINE

5. Remove the throttle valve switch (A / T), throttle sensor and AAC valve connectors.
6. Refer to the diagram below to remove each hoses.
 - The diagram refers to the reverse side of the intake manifold collector.
 - Remove the hose below the intake manifold collector after removing the installation bolts.

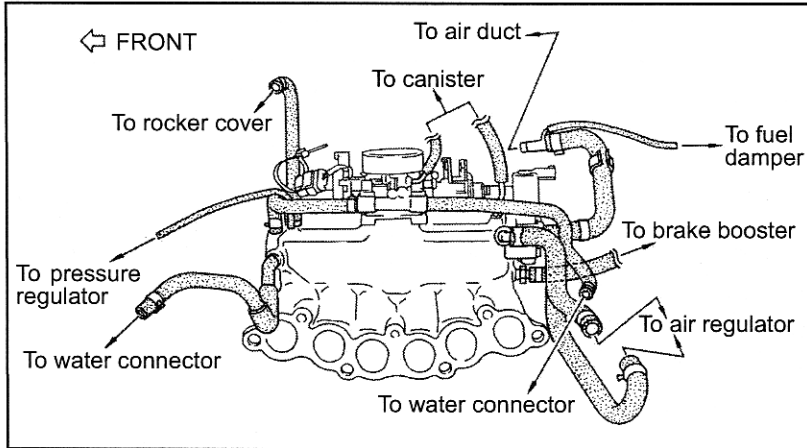

7. Remove the installation bolts in order shown in the diagram.
8. Remove the intake manifold collector.
9. Remove the intake manifold collector gasket.

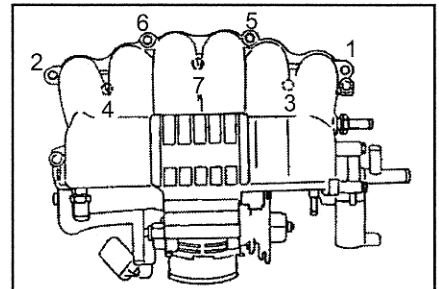

Inspection

Distortion of the intake manifold collector

(1) Completely remove the gasket on reverse side of the intake manifold collector.

- Use the straight gauge and the feeler gauge to measure the distortion in six directions.

Limit value (mm) 0.1

- If the distortion is over the limit use a surface grinder to repair distortion. Replace the intake manifold collector if the distortion is too excessive to fix.

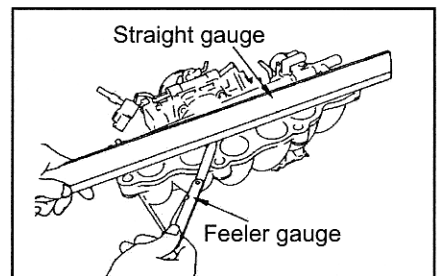

Installation

1. Install the intake manifold collector gasket.
 - Replace the gasket with a new one.
 - Remove any fluid, grease, rubbish etc. adhered to installation surface.
2. Install the intake manifold collector ASSY.
 - Care must be taken to select the correct bolt.

Installation position	Bolt underhead length (mm)
1	100
2, 3	37
4, 5	109
6, 7	Stud bolt + nut

RB20E ENGINE

- Install the installation bolts in the order shown in the diagram on the right.
- Make sure the gasket is fitted correctly.
Tightening torque (N-m{kg-m}) 18~22{1.8~2.2}
- 3. Install the rest in reverse order to the removal procedure.
- Make sure to tighten the hose clamp securely.

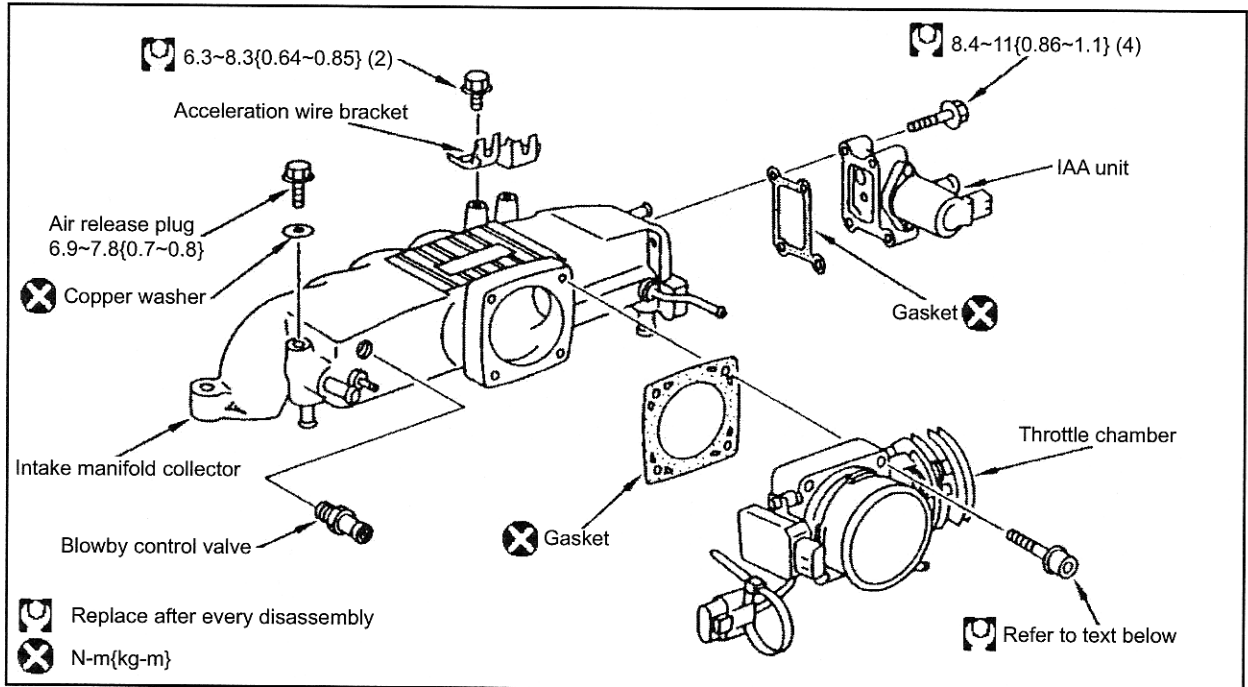
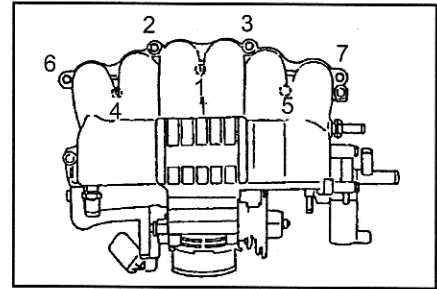

Disassembly

1. Remove the throttle chamber.
 - Remove the installation bolts in order shown.
2. Remove the IAA unit.

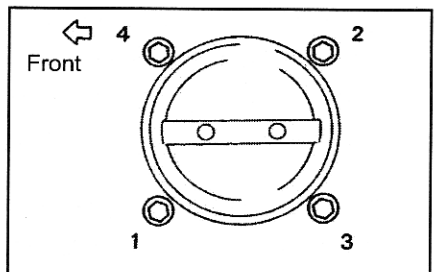

Assembly

1. Install the IAA unit.
 - Replace the gasket with a new one.
Tightening torque (N-m{kg-m}) 8.4~11{0.86~1.1}

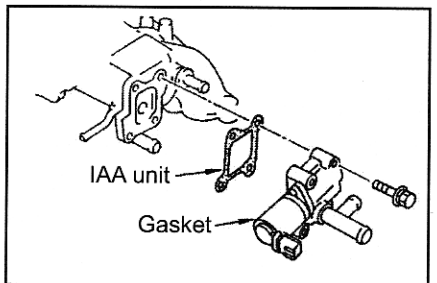

2. Install the throttle chamber.
 - Remove old gasket and other foreign objects adhered to installation surface.
 - Replace the gasket with a new one.
 - Install the bolts in two stages in the order shown.
Tightening torque (N-m{kg-m})

1st	8.8~11{0.9~1.1}
2nd	18~22{1.8~2.2}

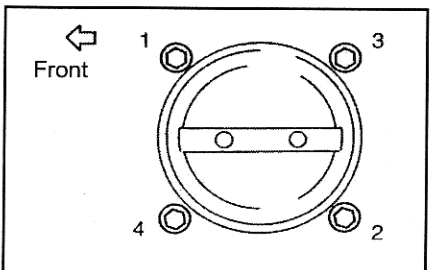

RB20E ENGINE

3. FUEL INJECTOR

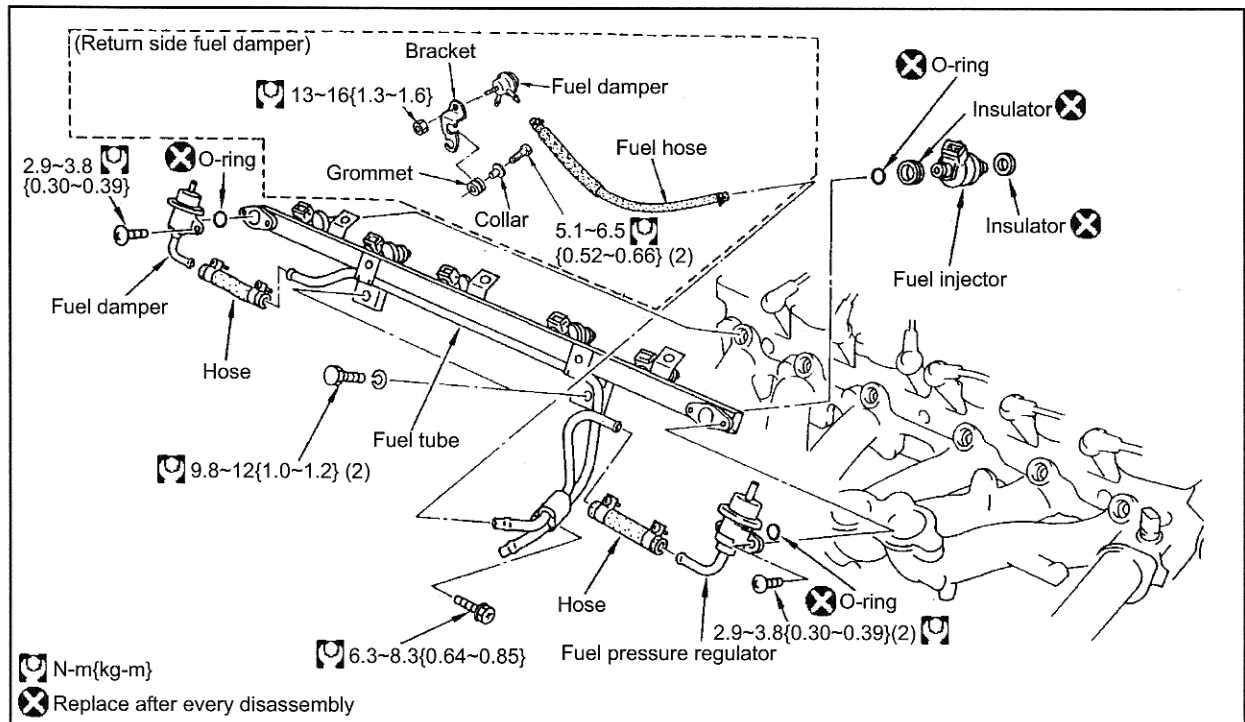

Removal

1. Release the fuel pressure.
2. Remove the battery negative terminal.
 - (1) Open the boot lid.
 - (2) Remove the boot front finisher and remove the negative battery terminal.
3. Drain coolant from the radiator drain plug.
4. Remove the air duct and resonator ASSY.
5. Remove the intake manifold collector.
6. Remove the fuel feed and return hose from fuel tube side.

Caution:

Make sure to place a hole cap to avoid fuel leakage.

7. Remove the fuel injector harness connector.
8. Remove the intake manifold front side fuel sub tube installation bolt.
9. Remove the fuel tube installation bolt to remove fuel tube and the injector ASSY.
 - Care must be taken not to drop insulator attached to the injector inside the engine bay when removing the injector ASSY.
10. Remove fuel injector from the fuel tube.

Caution:

- Care must be taken not to damage fuel injector.
 - Do not disassemble fuel injector.
11. Remove fuel pressure regulator (front side) and fuel damper (rear side) from the fuel tube.

Caution:

The fuel inside the fuel tube may leak.

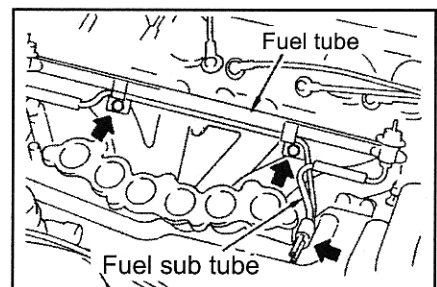
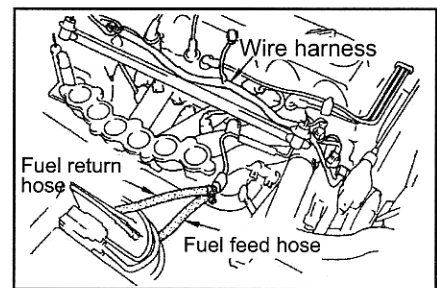

Inspection**Fuel tube & fuel hose**

- Look for any fuel leakage from the fuel tube and the fuel hoses.
- Replace with new ones if there are any abnormalities.

Installation

1. Install fuel pressure regulator (front side) and the fuel damper (rear side).
 - Replace O-ring with new ones.
 - Read the handling note before carrying out the operation.

Tightening torque (N-m{kg-m}) 2.9~3.8{0.30~0.39}

Handling note

- Always handle the O-ring with bare hands (no gloves).
- Only apply engine oil (7.5W-30 or similar viscosity) and never clean or soak the o-ring in a solvent solution.
- Avoid using dirty o-ring and devices with dust or other foreign objects adhered to it.
- When installing the o-ring care must be taken not to scratch the o-ring with tools or nails. Also do not twist or stretch them.
- When inserting fuel injector, pressure regulator or fuel dumper into the fuel tube, do not twist or turn the parts.

2. Install the fuel injector to fuel tube.
 - Replace the insulator (up & down) with a new one.
 - Replace the o-ring with a new one.

- Replace the insulator (up & down) with a new one.
- Replace the o-ring with a new one.

3. Install the fuel tube and the injector ASSY.

- Tighten right and left evenly.

Tightening torque (N-m{kg-m}) 9.8~12{1.0~1.2}

4. Fuel sub tube installation bolts.

Tightening torque (N-m{kg-m}) 6.3~8.3{0.64~0.85}

5. Install fuel injector harness connector.
6. Install fuel feed and return hose to fuel tube.
 - Install feed hose (fuel filter side hose) to fuel tube bottom side and install return hose to upper side.
7. Place the ignition switch to the ON position and apply pressure to the fuel pipings to check for any fuel leakage.
8. Install the rest in reverse order to the removal procedure.

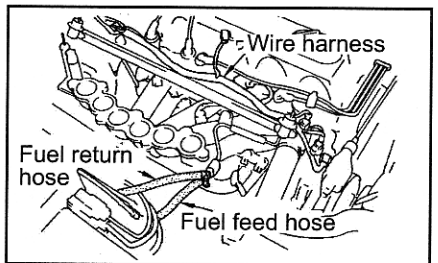
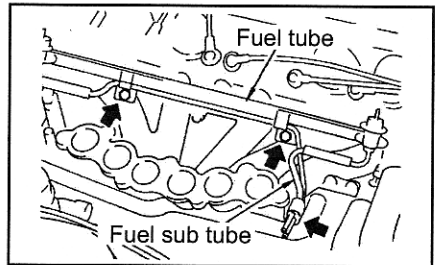
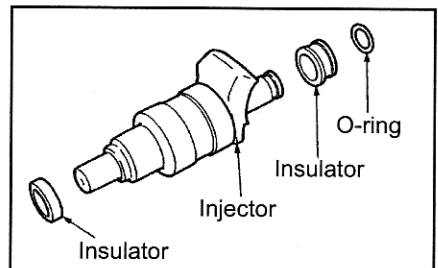
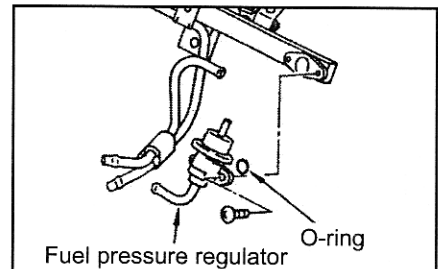

4. INTAKE MANIFOLD

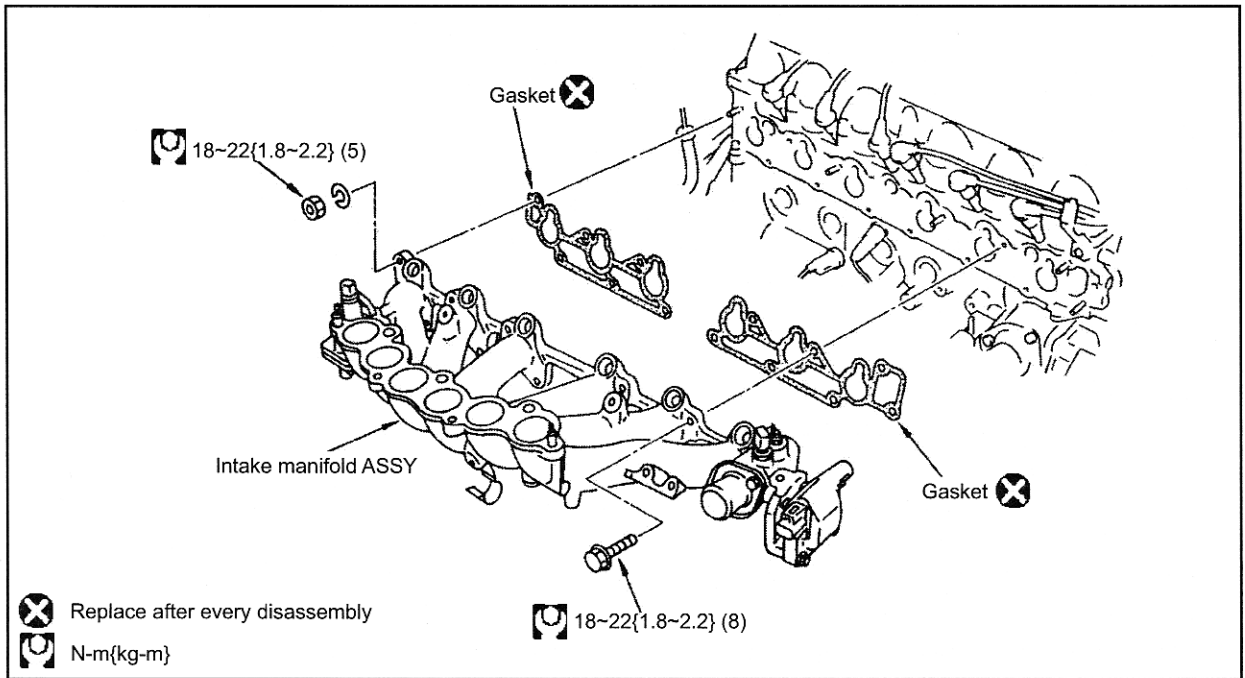

Removal

1. Release the fuel pressure.
2. Remove the battery negative terminal.
 - (1) Open the boot lid.
 - (2) Remove the boot front finisher and remove the negative battery terminal.
3. Drain coolant from the radiator drain plug.
4. Drain coolant from the cylinder block drain plug.
5. Remove the air duct and resonator ASSY.
6. Remove the intake manifold collector.
7. Remove the fuel injector.
8. Remove the connector and primary terminal from the ignition coil.
9. Disconnect the thermal transmitter and engine coolant temperature sensor connector.
10. Remove the radiator upper hose from water outlet side.
11. Disconnect the air regulator connector.
12. Disconnect two earth terminals.
13. Remove water hose from the bracket below the intake manifold.
14. Remove the intake manifold.
 - Remove installation bolts and nuts in the order shown in the diagram on the right.
15. Remove the intake manifold gasket.

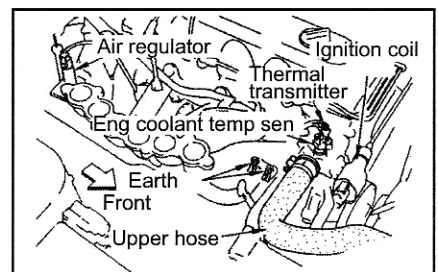

Nut: 1, 2, 4, 10, 12
 Bolt: 3, 5, 6, 7, 9, 11, 13

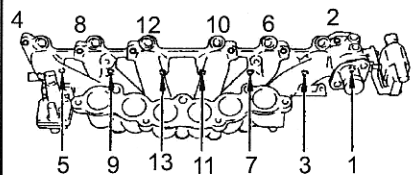

Inspection

Distortion of the intake manifold

- Use a straight gauge and the feeler gauge to measure the distortion of the front and reverse surface in six directions.

Limit value (mm) 0.1

- If the distortion is over the limit use a surface grinder to repair distortion. Replace the intake manifold if the distortion is too excessive to fix.

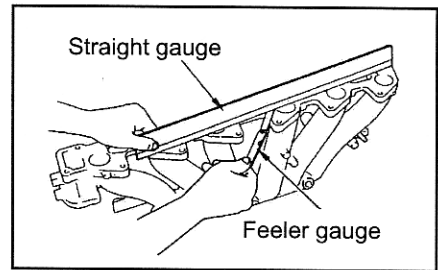

Installation

1. Install the intake manifold gasket.
 - Use scraper to remove any gasket or foreign objects etc. adhered to intake manifold and cylinder head installation surface.
 - Clean the surface using white gasoline.
 - Replace the gasket with a new one.
 - Make sure the coolant passage way is facing the front when installing the gasket.

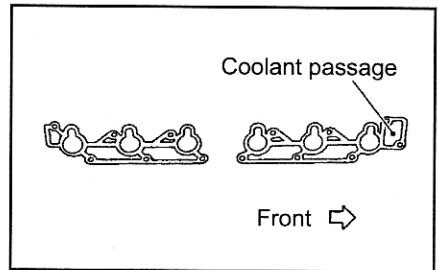

2. Install the intake manifold.
 - Tighten the installation bolts and nuts uniformly in several stages in order shown in the diagram on the right.

Tightening torque (N-m{kg-m}) 18~22{1.8~2.2}

3. Install the water hose to the bracket below intake manifold.
4. Connect two earth terminals.

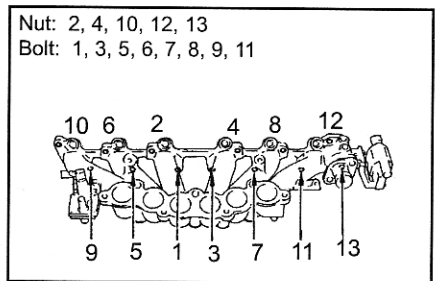

5. Install the air regulator connector.
6. Install the radiator upper hose to water outlet.
7. Install the engine coolant temperature sensor and thermal transmitter connector.
8. Install the connector and primary terminal to the ignition coil.
9. Install the rest in reverse order to the removal procedure.

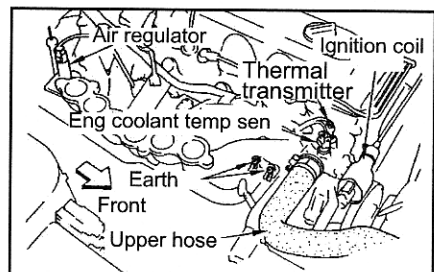

RB20E ENGINE

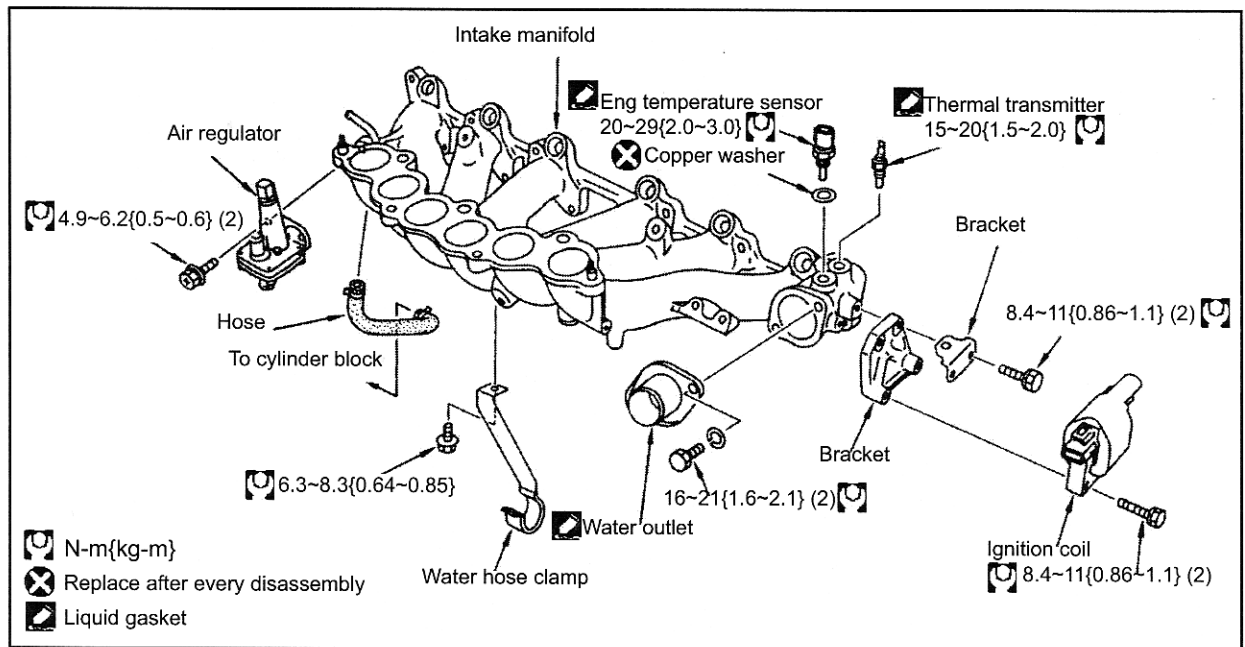

Disassembly

1. Remove the water outlet.
2. Remove the ignition coil.
3. Remove the ignition coil bracket.
4. Remove the thermal transmitter and water temperature sensor.
5. Remove the air regulator.

Assembly

1. Install the air regulator.
Tightening torque (N-m{kg-m}) 4.9~6.2{0.5~0.6}
2. Install the thermal transmitter and the water temperature sensor.
 - Replace the engine coolant temperature sensor copper washer with a new one.
 - Apply sealing agent to thread part and tighten to specified torque.

Thermal transmitter	Tightening torque (N-m{kg-m})	15~20{1.5~2.0}
Engine coolant temperature sensor	Tightening torque (N-m{kg-m})	20~29{2.0~3.0}
3. Install the ignition coil bracket.
Tightening torque (N-m{kg-m}) 8.4~11{0.86~1.1}
4. Install the ignition coil.
Tightening torque (N-m{kg-m}) 8.4~11{0.86~1.1}
5. Install the water outlet.

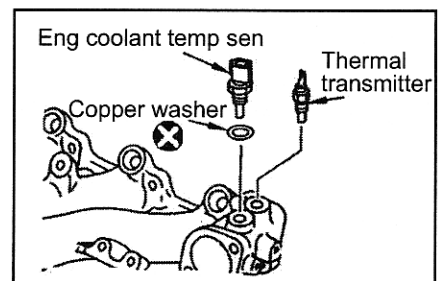

5. EXHAUST MANIFOLD

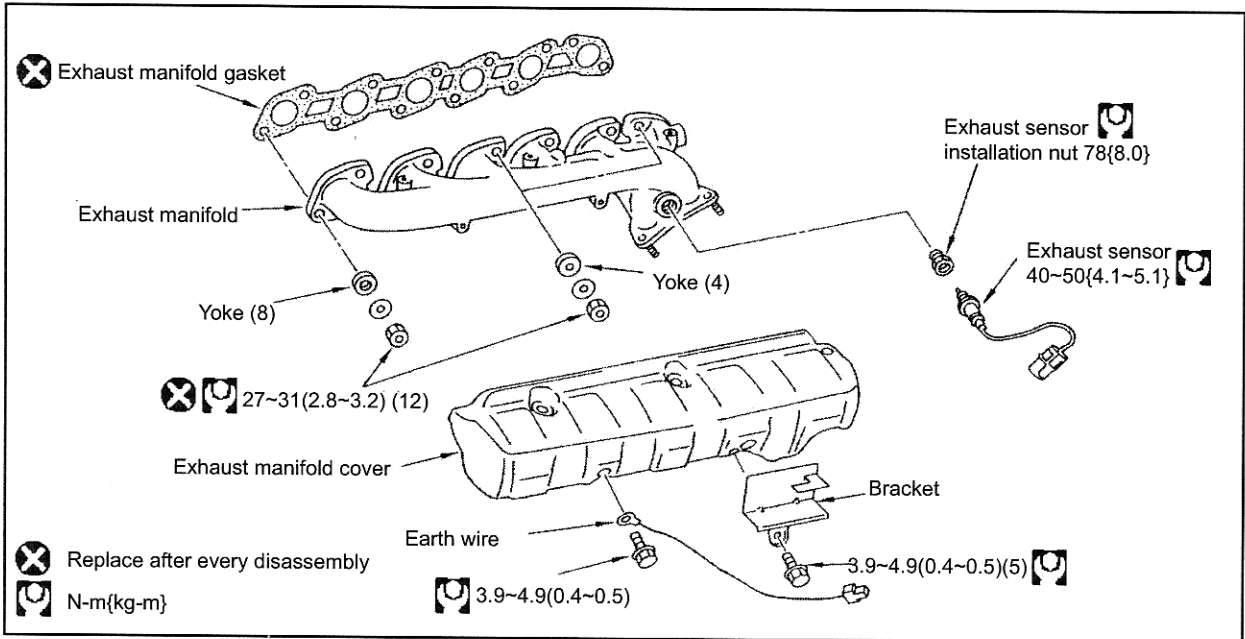

Removal

1. Remove the battery negative terminal.
 - (1) Open the boot lid.
 - (2) Remove the boot front finisher and remove the negative battery terminal.
2. Remove air duct and resonator ASSY.
3. Remove the exhaust front tube from exhaust manifold.
4. Remove the exhaust sensor connector.
5. Disconnect earth wire from the exhaust manifold cover side.
6. Remove the exhaust manifold cover.
7. Remove the exhaust sensor.
 - Care must be taken not to cause any damage to the exhaust sensor.
8. Remove the exhaust manifold.
 - Remove the installation nuts in the order shown in diagram on right.
9. Remove the exhaust manifold gasket.

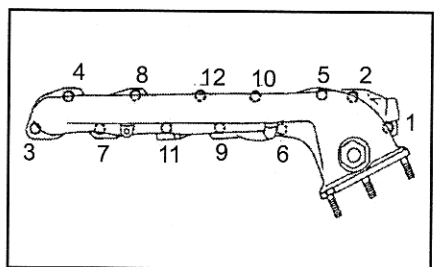
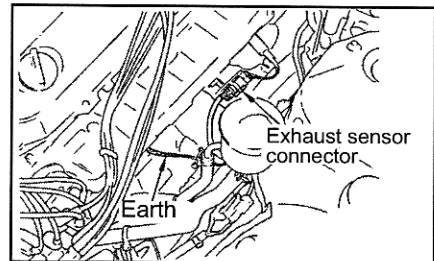

Inspection

Distortion of exhaust manifold

- Use a scraper to remove gasket on the installation surface.
- Use a straight gauge and feeler gauge to measure the installation surface distortion in four directions.

Limit value (mm)	0.3
------------------	-----
- If the distortion is over the limit use the surface grinder to repair distortion. Replace the exhaust manifold if the distortion is too excessive to fix.

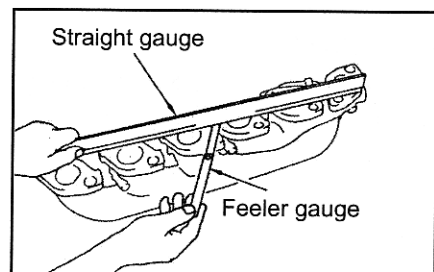

Installation

1. Install exhaust manifold gasket.
 - Use the scraper to remove gasket and other foreign object from exhaust manifold and cylinder head installation area.
 - Clean the installation surface with white gasoline.

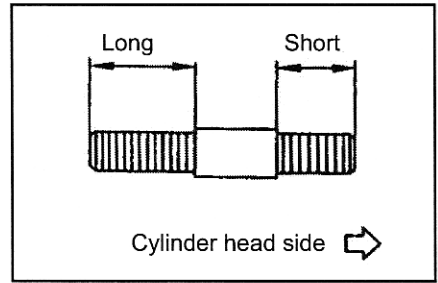

- When installing the stud bolt, make sure the stud bolt with shorter thread side if on the cylinder head side.
- Replace the gasket with a new one.
- Install the gasket in the correct direction shown.

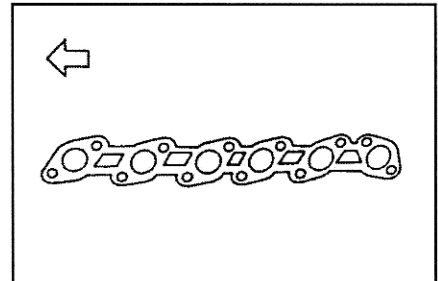

2. Install exhaust manifold.
 - There are No. 3, No.4 for port (4) and non-port (12) yokes. Make sure to use correct yoke for each parts.

Diameter ΦD (mm)	
No. 3, No. 4 port	22
No. 1, 2, 5, 6 port	24

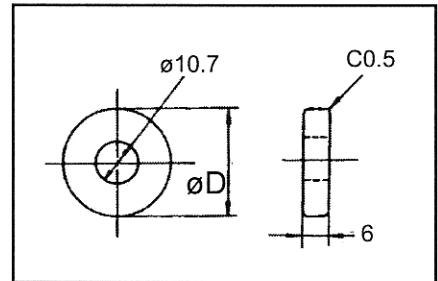

- Install the washer in the direction shown.
3. Install the exhaust manifold cover.

Tightening torque (N-m{kg-m})	3.9~4.9{0.4~0.5}
-------------------------------	------------------
 4. Install exhaust front tube.

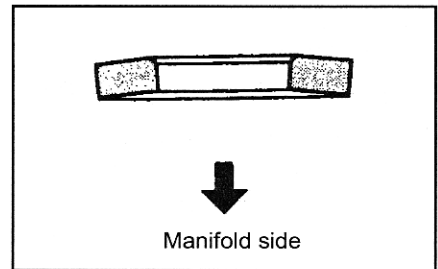

- Replace the installation nuts with a new one.
 - Tighten the installation nuts in the order shown in the diagram on the right.
- | | |
|-------------------------------|----------------|
| Tightening torque (N-m{kg-m}) | 27~31{2.8~3.2} |
|-------------------------------|----------------|

5. Install the rest in reverse order to the removal procedure.
6. Install exhaust sensor.

Tightening torque (N-m{kg-m})	
Exhaust sensor installation nuts	78{8.0}
Exhaust sensor	40~50{4.1~5.1}

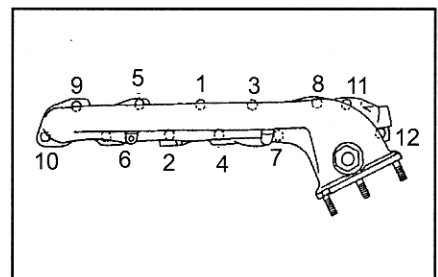

6. ROCKER COVER

Removal

1. Remove the battery negative terminal.
 - (1) Open the boot lid.
 - (2) Remove the boot front finisher and remove the negative battery terminal.
2. Remove the air duct and resonator ASSY.
3. Remove the blowby hose.

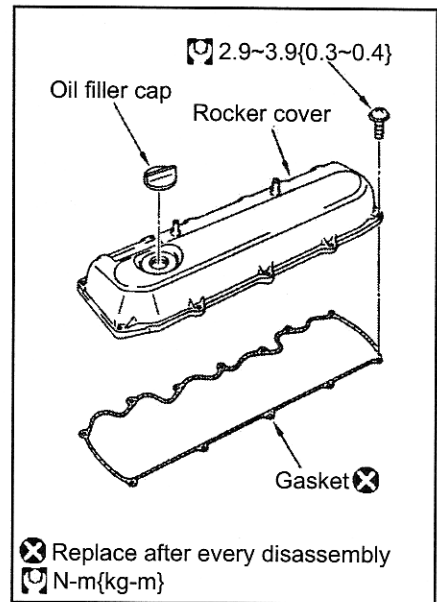

4. Remove installation screws in order shown in the diagram on the right.
5. Remove gasket from the rocker cover.

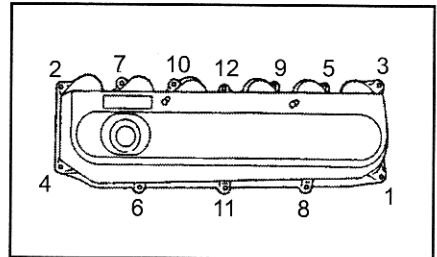

Inspection

- Check for any cracks, damage or oil leaking from the rocker cover.
- Replace the rocker cover if any abnormality is found.
- Make sure engine oil is not leaking from between the rocker cover and the cylinder head.

Installation

1. Install the gasket to rocker cover.
 - Replace the gasket with a new one.
 - Install the gasket to rocker cover installation groove securely.
2. Install the rocker cover.
 - Remove any oil and rubbish etc. from cylinder head side installation surface.
 - Tighten installation screws in order shown in the diagram on the right.

Tightening torque (N-m{kg-m}) 2.0~3.9{0.2~0.4}
3. Install the rest in reverse order to the removal procedure.

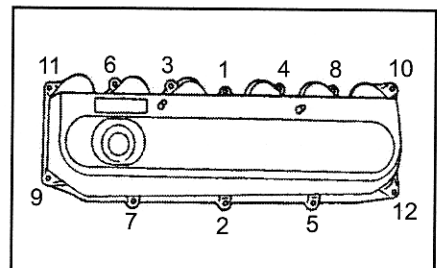

RB20E ENGINE

7. ROCKER SHAFT

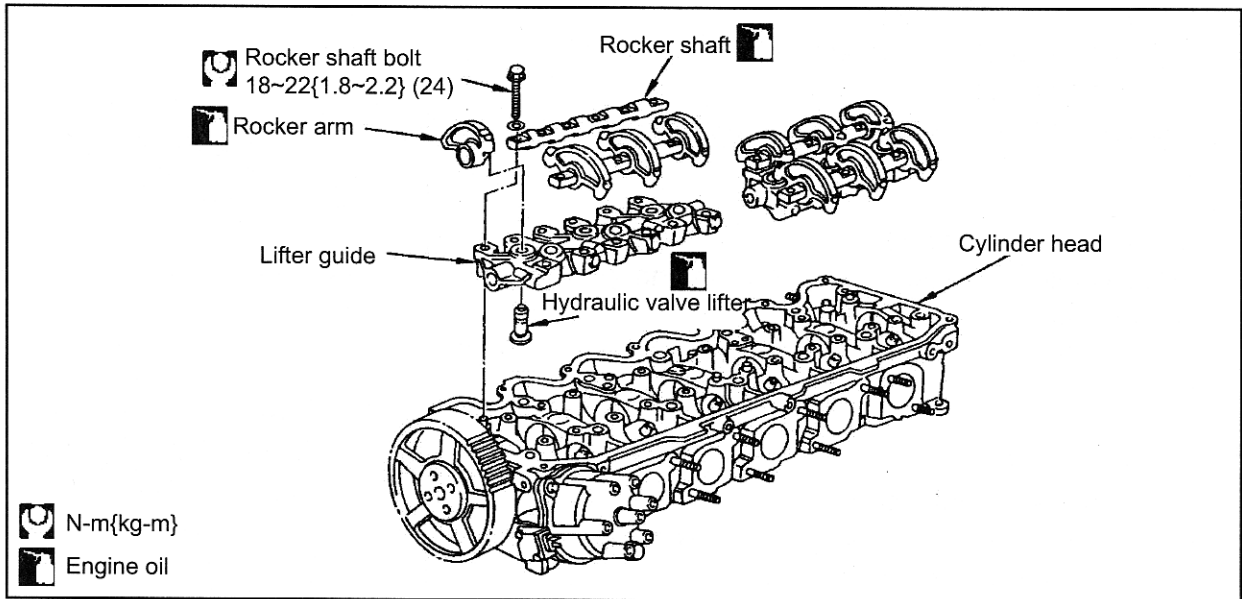
**Removal**

1. Remove the battery negative terminal.
 - (1) Open the boot lid.
 - (2) Remove the boot front finisher and remove the negative battery terminal.
2. Remove the air duct and resonator ASSY.
3. Remove the rocker cover.
4. Remove the rocker shaft and rocker arm ASSY by removing the rocker shaft bolt.
5. Remove the rocker arm from the rocker shaft.
 - Check the installation position and store it away to avoid confusion.
6. Remove the lifter guide together with hydraulic lifter.
 - Secure each hydraulic valve lifter with wire etc. and remove carefully without dropping.
7. Remove the hydraulic valve lifter from the lifter guide.
 - Check the installation position and store it away to avoid confusion.
 - Store the hydraulic valve lifter in stand up position. If stored for a longer period of time, store it in clean engine oil.
 - Do not disassemble hydraulic valve lifter.

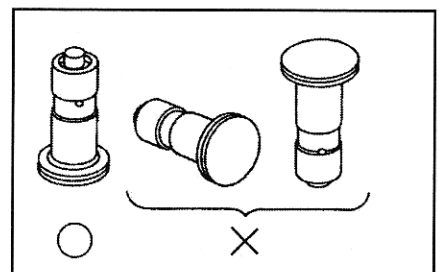
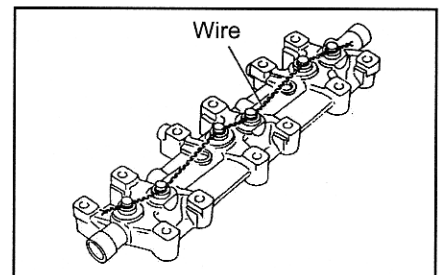

Inspection**Rocker shaft visual inspection**

- Visually inspect rocker arm rotational part for any wear or damage.
- If there are any abnormalities replace with a new one.

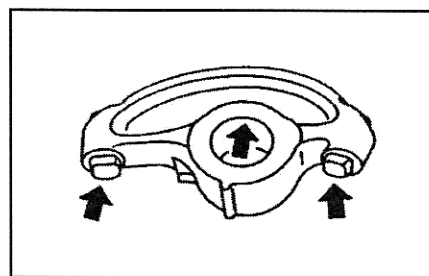
**Rocker arm visual inspection**

- Visually inspect rocker arm and rotational part for any wear or damage.
- If there are any abnormalities replace with a new one.

Rocker arm oil clearance**(Rocker shaft external diameter)**

- Use micrometer to measure the external diameter near the rocker shaft oil groove.

Standard value (mm) $\Phi 17.979 \sim 18.000$

(Rocker arm internal diameter)

- Use inside micrometer to measure the internal diameter of the rocker arm shaft hole.

Standard value (mm) $\Phi 18.007 \sim 18.028$

(Rocker arm oil clearance) =

(Rocker arm internal diameter) -

(Rocker shaft external diameter)

Standard value (mm) $\Phi 0.007 \sim 0.049$

- Replace rocker arm or rocker shaft if the standard value is incorrect.

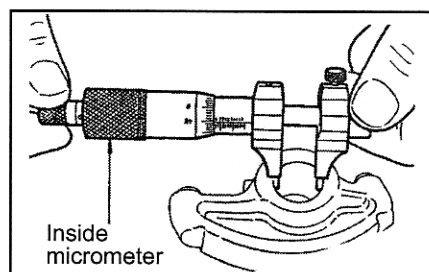
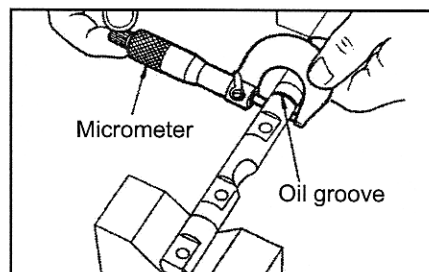
**Hydraulic valve lifter visual inspection**

- Visually inspect cam shaft working surface, lifter surface and guide rotational parts for any wear or damage. Replace with a new one if there are any abnormalities.

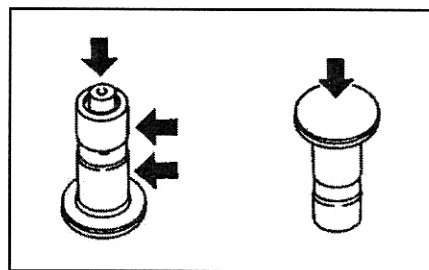
**Hydraulic valve lifter clearance****(Hydraulic valve lifter external diameter)**

- Use micrometer to measure the external diameter of hydraulic valve lifter.

Standard value (mm) $\Phi 15.947 \sim 15.957$

(Hydraulic valve lifter hole diameter)

- Use inside micrometer to measure the diameter of hydraulic valve lifter hole diameter.

Standard value (mm) $\Phi 16.000 \sim 16.013$

(Hydraulic valve lifter clearance) =

(valve lifter hole diameter) -

(valve lifter external diameter)

Standard value (mm) $\Phi 0.043 \sim 0.066$

- Replace rocker arm or rocker shaft if the standard value is incorrect.

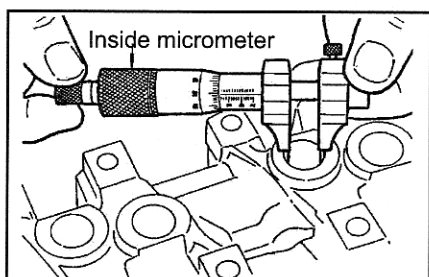
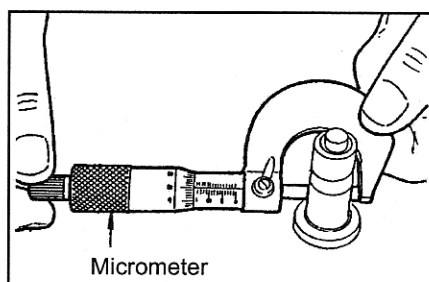

RB20E ENGINE

Hydraulic valve lifter air interfusion inspection

- Apply engine oil to rotational surface to install.
 - After installation push down on the plunger head. If it moves more than 1mm carry out the air release operation using method below. (Use same method to check the valve lifter when abnormal sound is heard when the engine is started).
- (1) After installing the rocker cover, run the engine at approx. 1000rpm with no-load for 10 minutes. Recheck the plunger head movement.
 - (2) If the air is not released by carrying out above method, replace the hydraulic valve lifter with a new one.

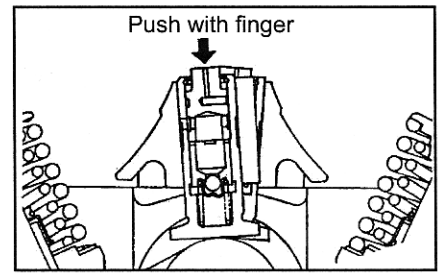
**Installation**

1. Install the hydraulic valve lifter to the lifter guide.
 - Apply engine oil to rotational parts.
 - Install parts back in same position as before removal and fix using wire etc. to avoid them falling into the engine bay.
2. Install the lifter guide.
 - The front (No. 1~3 cylinders) and the rear (No. 4~6 cylinders) can be distinct by molded mark F and R. Make sure the molded marks are facing correct direction as shown in the diagram on the right.
3. Install rocker arm to the rocker shaft.
 - Apply engine oil to rotational parts, the valve lifter and the valve stem contact part.
 - Install them back in same position.
 - The front (No. 1~3 cylinders) and the rear (No. 4~6 cylinders) rocker arm are shaped different. Care must be taken to place them correctly.
- The front (No. 1~3 cylinders) and the rear (No. 4~6 cylinders) rocker shaft are shaped different. They can be distinct by distinction mark.
4. Install the rocker shaft and the rocker arm ASSY.
 - Check the front and rear before installing.
 - When installing the rocker shaft make sure the cylinder head bolt installation notch is facing out.

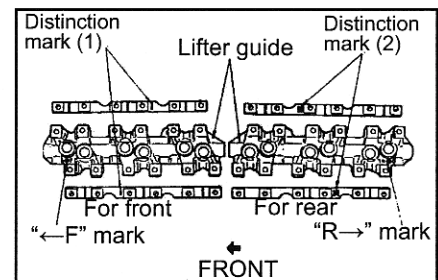
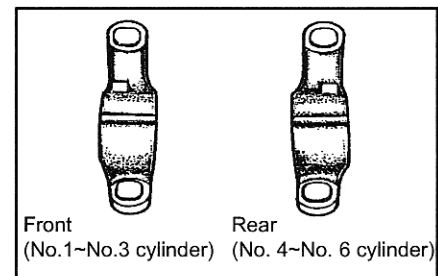
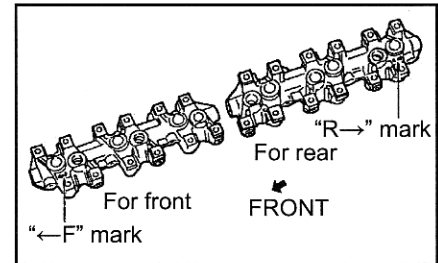
**Caution:**

Do not completely tighten the rocker shaft bolts.

RB20E ENGINE

5. Tighten rocker shaft bolts.
 - Use the following method to tighten the rocker shaft bolts uniformly.
 - (1) Position No.1 cylinder at T.D.C (top dead centre) position.
 - (2) Tighten No.4~6 cylinder rocker shaft bolts.
Tightening torque (N-m{kg-m}) 18~22{1.8~2.2}
 - (3) Position No.6 cylinder at T.D.C by turning the crankshaft once.
 - (4) Tighten No.1~3 cylinder rocker shaft bolts.
Tightening torque (N-m{kg-m}) 18~22{1.8~2.2}
6. Make sure there is no trapped air inside the hydraulic valve lifter.
7. Install the rest in reverse order to the removal procedure.
8. Start the engine and make sure there is no abnormal sound from the hydraulic valve lifter.

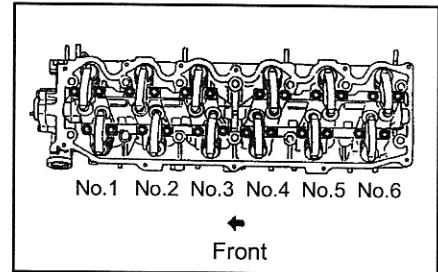

RB20E ENGINE

8. CAM SHAFT

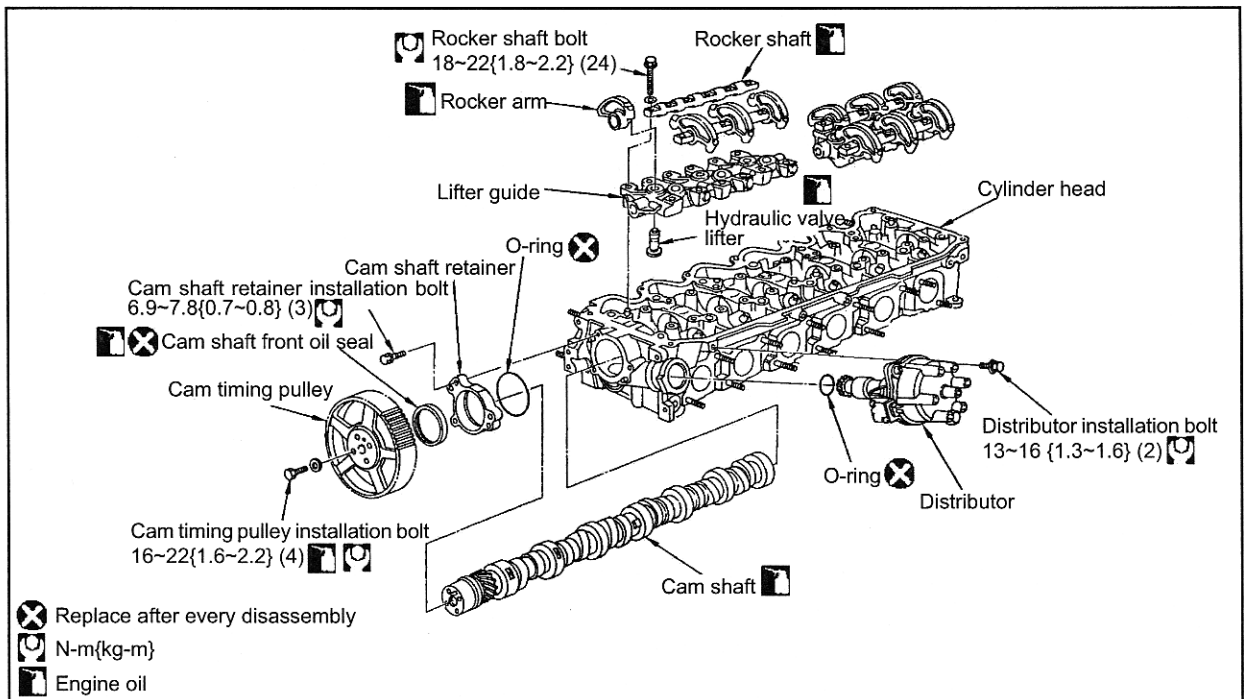
**Removal**

1. Release the fuel pressure.
2. Remove the battery negative terminal.
 - (1) Open the boot lid.
 - (2) Remove the boot front finisher and remove the negative battery terminal.
3. Remove the under cover.
4. Drain coolant from the radiator drain plug.
5. Drain coolant from the cylinder block drain plug.
6. Remove the radiator upper hose and the lower hose from engine side.
7. Remove the air duct and the resonator ASSY.
8. Remove the intake manifold collector.
9. Remove the fuel injector.
10. Remove the intake manifold.
11. Remove the exhaust front tube.
12. Remove the exhaust manifold.
13. Remove the cooling fan.
14. Remove the radiator.
15. Remove the auxiliary belt.
16. Remove the timing belt.
17. Remove the rocker cover.
18. Remove the cylinder head.
19. Remove the distributor.
20. Remove the rocker shaft and the rocker arm ASSY.
21. Remove the lifter guide.
22. Remove the cam timing pulley.
 - Use pulley holder to fix the cam timing pulley to remove the installation bolts.
23. Remove the cam shaft retainer.

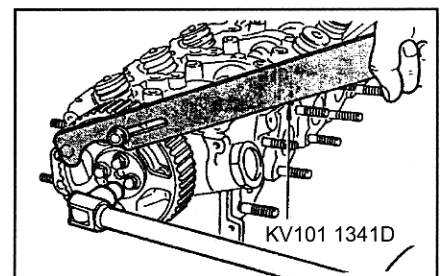

RB20E ENGINE

24. Remove front oil seal from the cam shaft retainer.

- Use negative driver to remove oil seal from the cam shaft retainer.

25. Remove the cam shaft.

- Carefully remove journal and the cam from the cylinder head, making sure they will not touch the cam shaft bracket.

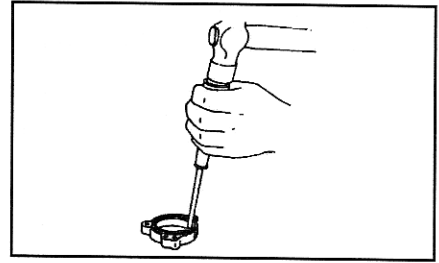
**Inspection**

Cam shaft visual inspection

- Check to make sure there is no damage or wear to the cam shaft.
- Replace if any abnormalities are found.

Cam shaft run-out

- Use V-block on the fixed surface and support cam shaft No. 1 and No. 7 journal.
- Set dial gauge vertically to No. 4 journal.
- Rotate the cam shaft in one direction and read the movement width on the dial gauge.
- Cam shaft run-out is equal to half of movement width indicated on dial gauge.

Limit value (mm) 0.01

- If the run-out is over the limit value replace the cam shaft.

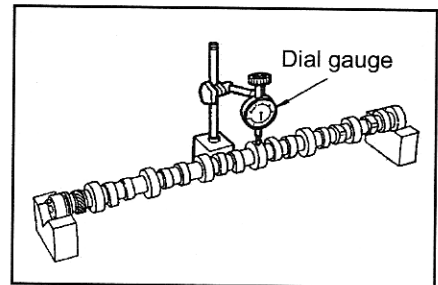

Cam nose height

- Use micrometer to measure cam nose height.

Standard value (mm)	Intake	39.242~39.432
	Exhaust	39.123~39.313

Wear out limit value (mm)	Intake	0.05
	Exhaust	0.05

- If the value is over the limit replace the cam shaft.

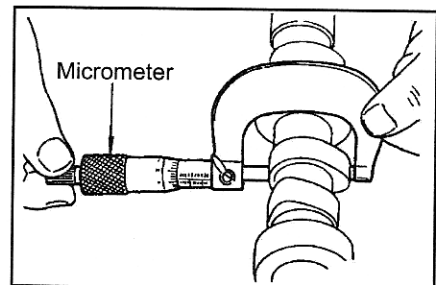

Cam shaft oil clearance

(Cam journal external diameter)

- Use micrometer to measure cam journal external diameter.

Standard value (mm)	
(No.1~No.6 journal)	$\Phi 46.935 \sim \Phi 47.025$
(No.7 journal)	$\Phi 46.415 \sim \Phi 46.435$

(Cam bracket internal diameter)

- Use bore gauge to measure.

Standard value (mm)	
(No.1~No.6 journal)	$\Phi 47.000 \sim \Phi 47.025$
(No.7 journal)	$\Phi 46.500 \sim \Phi 46.525$

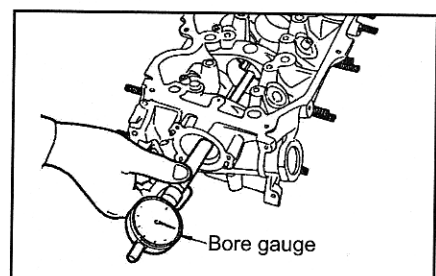
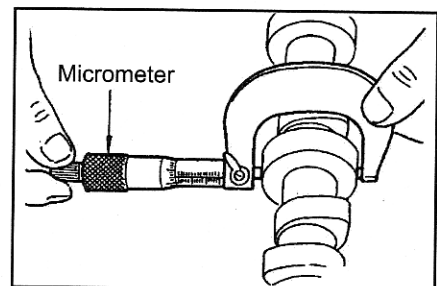

RB20E ENGINE

(Cam oil clearance) =

(Cam bracket internal diameter) -
(Cam journal external diameter)

Standard value (mm)

(No.1~No.6 journal) 0.045~0.090

(No.7 journal) 0.056~0.110

- If the value is not within standard value, replace cylinder head ASSY or cam shaft.

Cam shaft end play

- Set a dial gauge at front end of the cam shaft in thrust direction. Move the cam shaft forwards and backwards and read the dial gauge run-out measurement. Standard value (mm) 0.030~0.060
- If the value is not within standard value, replace the cam shaft. Re-measure and if the value is still not at standard value, also replace the cylinder head.

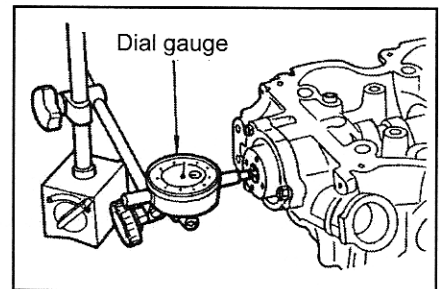

Installation

1. Install the cam shaft.
 - Apply engine oil to cam nose and the cam journal.
 - When installing make sure the knock pin on front side of the cam shaft is facing upwards.
 - Insert the journal and the cam straight so that it will not interfere with cam bracket.

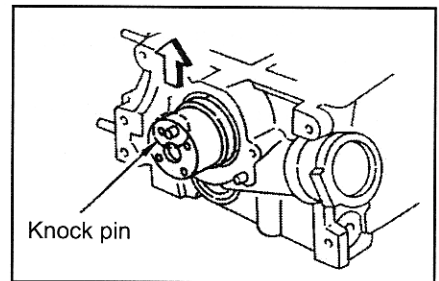

2. Install the cam shaft retainer.
 - If the cam shaft front oil seal has been removed, install the retainer without attaching the oil seal at this stage.
 - Replace the O-ring with a new one.

Tightening torque (N-m{kg-m}) 6.9~7.8{0.7~0.8}

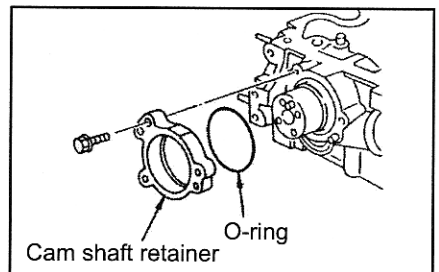

3. Install the cam shaft front oil seal.
 - Apply engine oil to oil seal lip area.
 - Carefully tap in the oil seal using 41mm box etc. until level with retainer front surface.

Caution:

Do not tap the oil seal too hard as it will block retainer oil return.

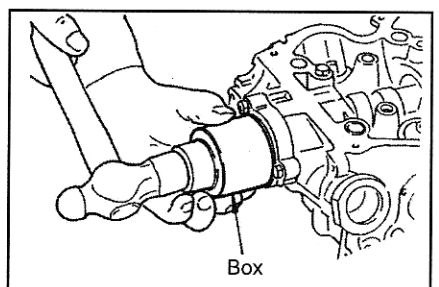

RB20E ENGINE

4. Install cam timing pulley.
 - When installing the washer face the side with chamfered internal diameter to bolt side.
 - Apply engine oil to installation bolt thread part.

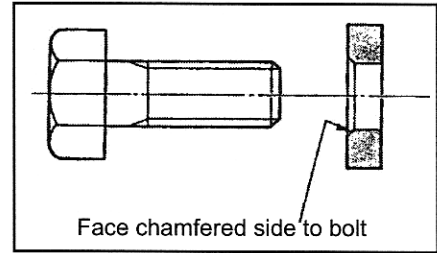

5. Use pulley holder to fix the cam timing pulley and tighten the bolts.
Tightening torque (N-m{kg-m}) 16~22{1.6~2.2}

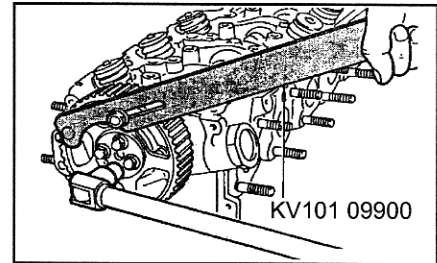

6. Install the distributor.
 - Replace the o-ring with a new one.
 - Make sure No.1 cylinder is at compression T.D.C position.
 - Install the distributor driven gear by aligning the distributor driven gear alignment mark to small housing side alignment mark.
 Tightening torque (N-m{kg-m}) 13~16{1.3~1.6}

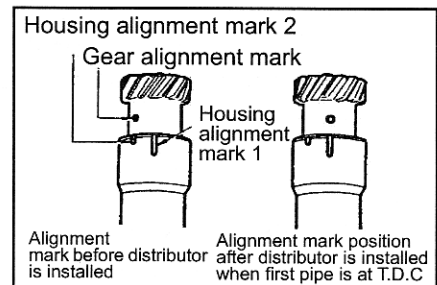

7. Install the rest in reverse order to the removal procedure.

RB20E ENGINE

9. CYLINDER HEAD GASKET

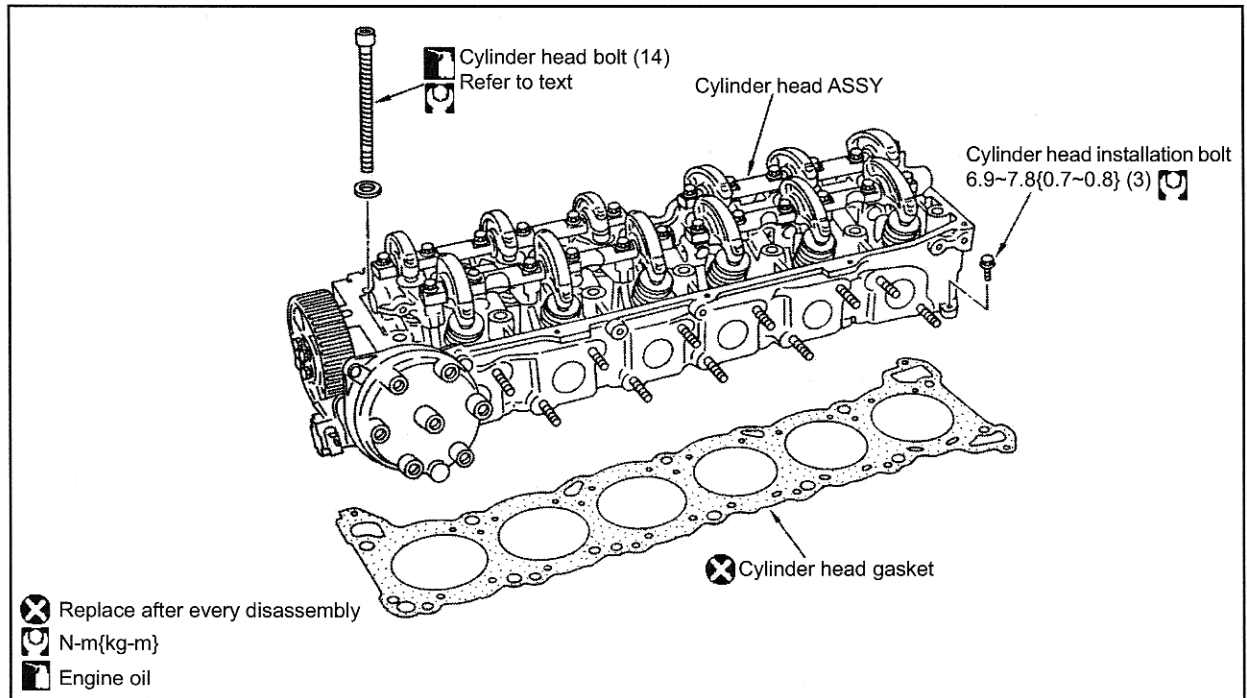
**Removal**

1. Release the fuel pressure.
2. Remove the battery negative terminal.
 - (1) Open the boot lid.
 - (2) Remove the boot front finisher and remove the negative battery terminal.
3. Remove the under cover.
4. Drain coolant from the radiator drain plug.
5. Drain coolant from the cylinder block drain plug.
6. Remove the radiator upper hose and the lower hose from engine side.
7. Remove the air duct and the resonator ASSY.
8. Remove the intake manifold collector.
9. Remove the fuel injector.
10. Remove the intake manifold.
11. Remove the exhaust front tube.
12. Remove the exhaust manifold.
13. Remove the cooling fan.
14. Remove the radiator.
15. Remove the auxiliary belt.
16. Remove the timing belt.
17. Remove the rocker cover.
18. Remove the cylinder head ASSY.
 - Remove the cylinder head auxiliary bolts in the order shown.

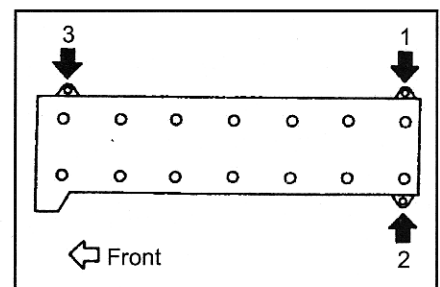

RB20E ENGINE

- Remove the cylinder head bolts in the order shown.
19. Remove the cylinder head gasket.

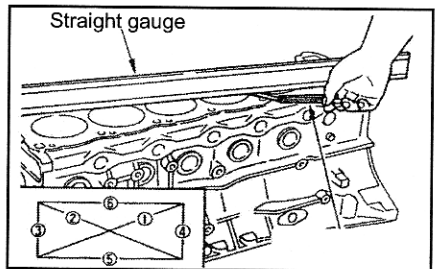
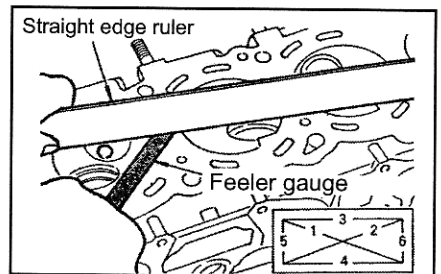
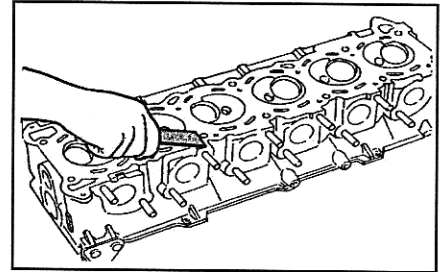
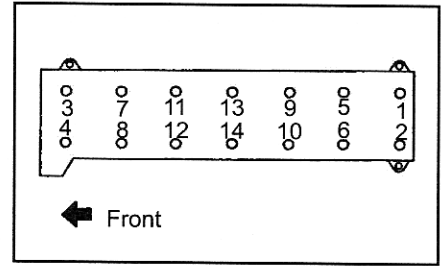
**Inspection**

Cylinder head distortion

- Use a scraper to remove gasket.

Caution:

Care must be taken not to allow removed gasket to enter oil and coolant passage.

- Measure cylinder head under surface for distortion in six directions.

Limit value (mm) 0.2

- If the value exceeds the limit apply compound to press platen and readjust the surface. If the value exceeds the limit greatly, replace the cylinder head with a new one.

Cylinder block top surface distortion

- Use the scraper to completely remove gasket, oil, water stains and carbon etc. on the cylinder block front surface.

Caution:

Care must be taken not to allow removed gasket to enter oil and coolant passage.

- Measure distortion of the block top surface in six directions using straight gauge.

Limit value (mm) 0.1

- If the value is over the limit use a surface grinder to correct the distortion.
- Replace the cylinder block if the distortion value is too great.

Installation

- Install the cylinder head gasket.
- Replace the gasket with a new one.
 - Use a scraper to remove gasket and other foreign objects from cylinder block side and cylinder head side installation surface.

Caution:

Care must be taken not to allow foreign objects to enter oil and coolant passage.

- Clean the surface using white gasoline.
- Install the gasket aligning to knock pin.

RB20E ENGINE

2. Install the cylinder head.
 - Make sure the No.1 cylinder head is at T.D.C position.
 - Check that No.1 cylinder intake and exhaust valve is not raised.
 - Install the cylinder head carefully trying not to damage the cylinder head gasket.

3. Tighten the cylinder head bolts.
 - Apply engine oil to thread part and bearing surface.
 - Install the washer with non-chamfered side facing the cylinder head.

4. Tighten the cylinder head bolts in order shown in the diagram to the right.
 - (1) Tighten to 29N-m{3kg-m}
 - (2) Tighten to 78N-m{8kg-m}
 - (3) Loosen to 0N-m{0kg-m}
 - (4) Tighten to 25~34N-m{2.5~3.5kg-m}
 - (5) Tighten to 100° ~ 105°. If you don't have an angle wrench tighten to 78~88N-m{8.0~9.0kg-m}

Caution:

Rotation angle should be checked using angle wrench or protractor. Never estimate visually.

5. Tighten the cylinder head auxiliary bolts in the order shown in the diagram to the right.
6. Install the rest in reverse order to the removal procedure.

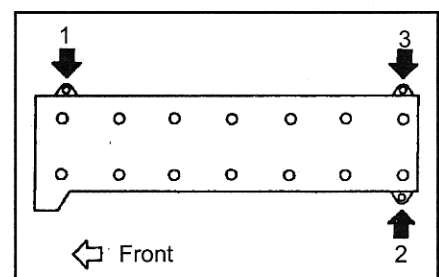
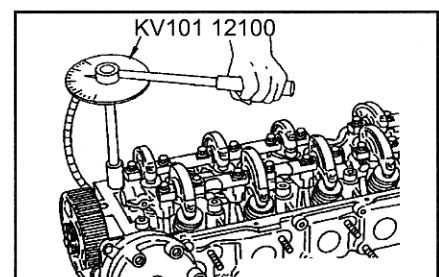
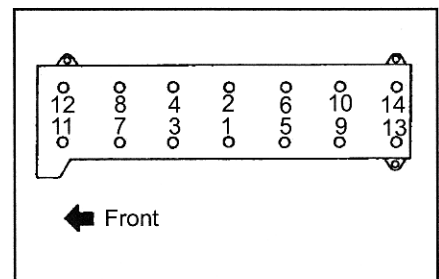
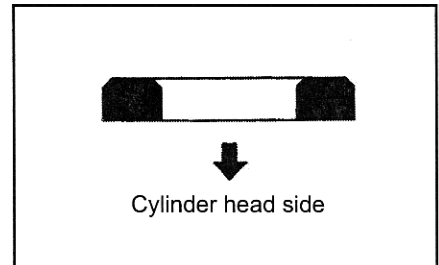

10. OIL PAN & OIL FILTER

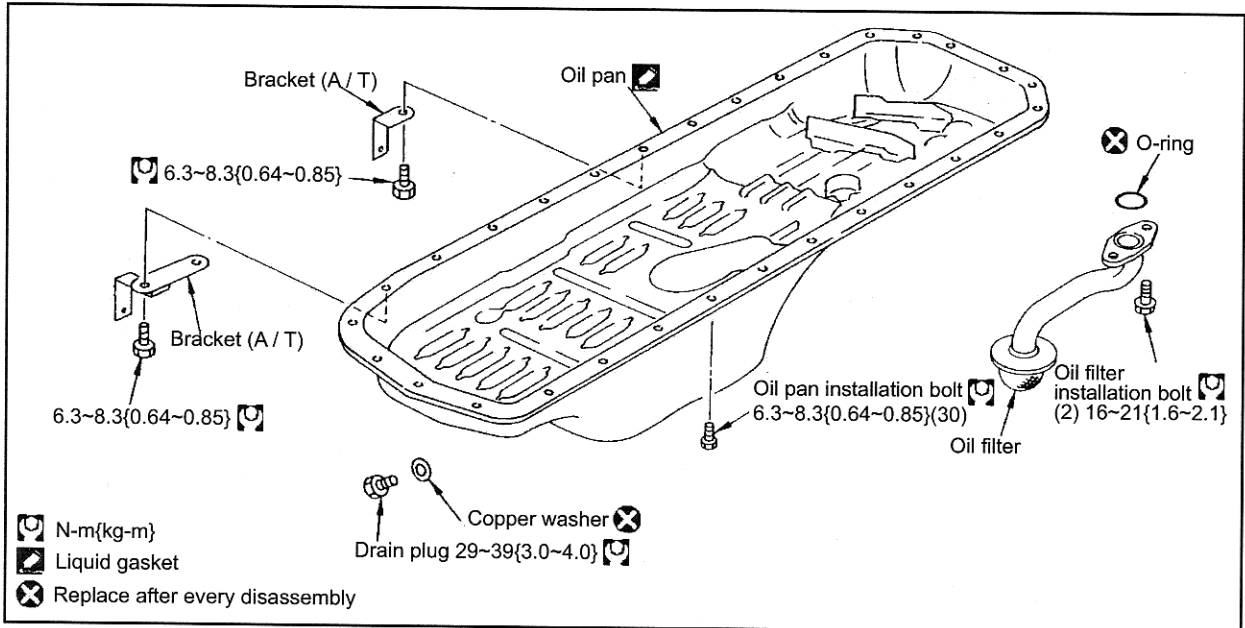

Removal

1. Remove the battery negative terminal.
 - (1) Open the boot lid.
 - (2) Remove the boot front finisher and remove the negative battery terminal.
2. Remove the under cover.
3. Drain engine oil from the oil pan drain plug.
4. Remove the tension rod.
5. Remove the stabilizer. OR remove stabilizer installation bolts and installation nuts located on the vehicle side and lower the stabilizer to below the oil pan.
6. Remove A / T oil cooler tube from the oil pan bracket.
7. Remove right and rear gasket.
8. Remove the lower rear plate (A / T vehicles).
9. Remove right and left front side engine mount installation nuts.
10. Attach a sling to the engine and raise using a hoist.

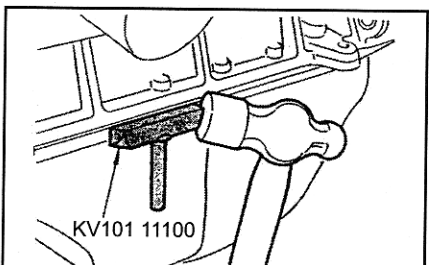
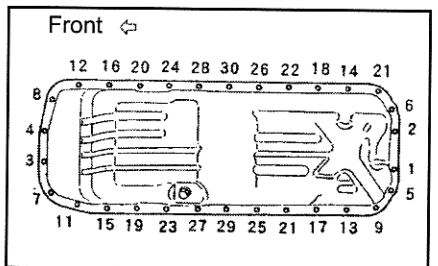
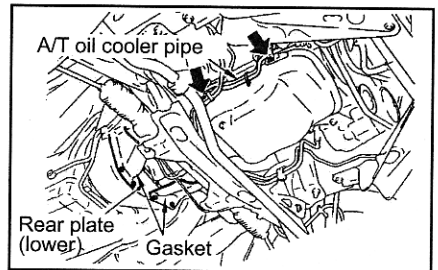
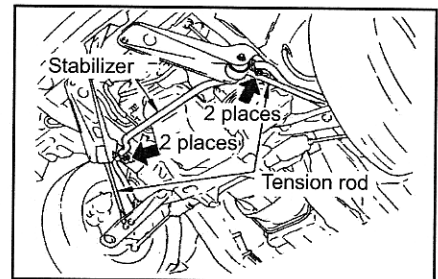

11. Remove installation bolts in the order shown in the diagram to the right.

12. Remove oil pan from the cylinder block.
 - (1) Insert seal cutter between the oil pan and the cylinder block.
 - (2) Tap the seal cutter rear surface using a hammer to remove the oil pan.

RB20E ENGINE

13. Remove oil pan.

- Remove the oil pan carefully making sure it will not interfere with oil filter net area.

14. Remove the oil filter.

Inspection

Oil filter visual inspection

- Check that there are no foreign objects on the oil filter net.
- Clean the net if there are any foreign objects.
- Replace with new one if there are any fault.

Installation

1. Install the oil filter.

- Replace the o-ring with a new one.

Tightening torque (N-m{kg-m}) 16~21{1.6~2.1}

2. Install the oil pan.

- Use scraper to remove any oil liquid gasket on the oil pan and cylinder block installation surface.
- Clean the installation surface using white gasoline.
- Apply bond (KP510 00150) to specified position shown in the diagram on right at approx. $\Phi 3.5\sim 4.5$.
- Place the oil pan below cylinder block. Care must be taken not to allow liquid gasket to come in contact with the cylinder block and other parts.
- Place 2 bolts (M6 x 1.25) at suitable position and tighten temporarily. Install other bolts temporarily.
- Tighten the bolts to specified torque in order shown in the diagram on right.
Tightening torque(N-m{kg-m}) 6.3~8.3{0.64~0.85}
- No. 2 and No. 20 installation bolts will also tighten A / T oil cooler pipings.

Caution:

Do not over tighten the installation bolts.

3. Install oil pan drain plug.

- Replace the washer with a new one.
- Install in the direction shown.

Tightening torque (N-m{kg-m}) 29~39{3.0~4.0}

- 4. Install the rest in reverse order to the removal procedure.

Inspection

- Check the level of engine oil.

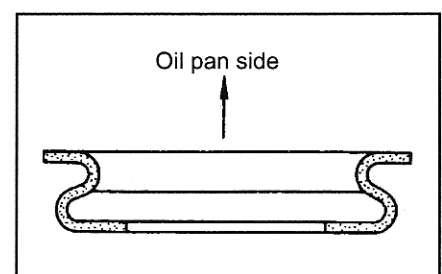
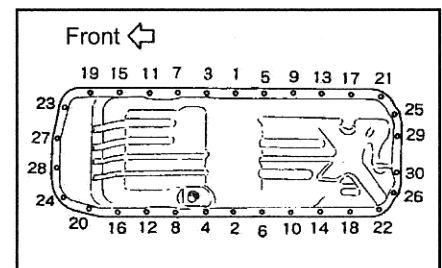
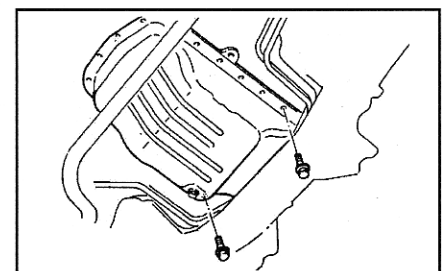
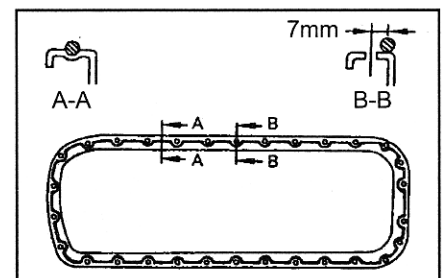
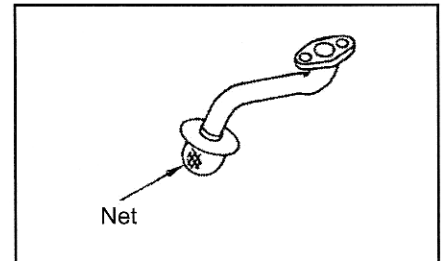
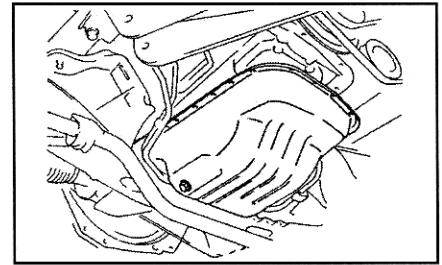

11. COLLECTOR ASSY

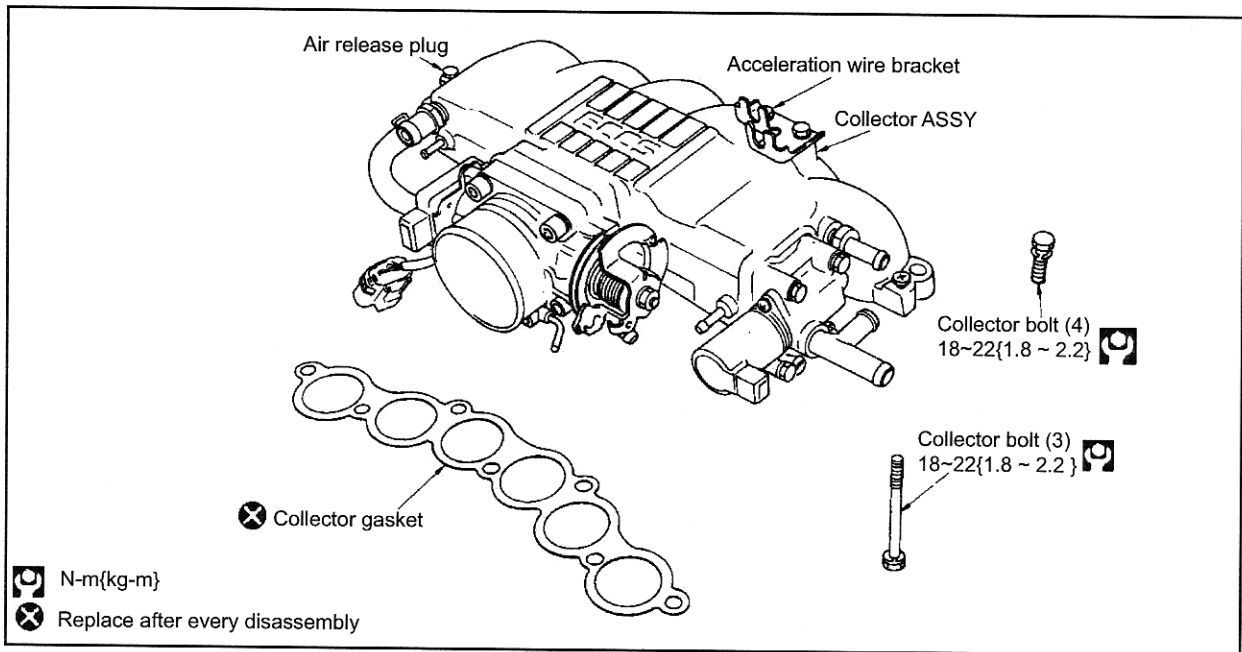
**Removal**

1. Release the fuel pressure inside the fuel pipings.
 - Start the engine.
 - After starting the engine remove the fuel pump fuse and wait until the engine stops. Crank the engine two or three times to consume fuel remaining in the fuel pipes.
 - If the vehicle doesn't start, remove the fuel pump and the fuse and crank the engine four to five times to consume fuel remaining in the fuel pipes.

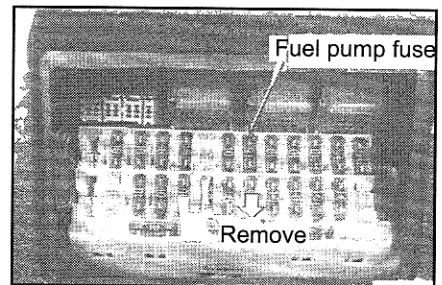
**Caution:**

The battery may become weak, use booster cable to connect to another battery if necessary.

2. Accelerator wire adjustment.
 - Provide adequate slack for the acceleration wire and use the lock nut to pull the outer case in the direction of the accelerator pedal.
 - Return the lock nut 1.0 ~ 1.5 turns from the position where the throttle drum starts moving (no play at this time) and tighten securely.

Tightening torque (N-m{kg-m}) 8~10{0.8~1.0}

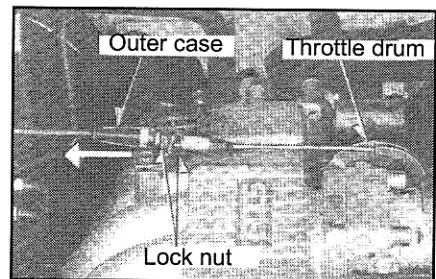

3. Remove the collector bolts.
 - Remove the bolts in order shown in the figure on the right.

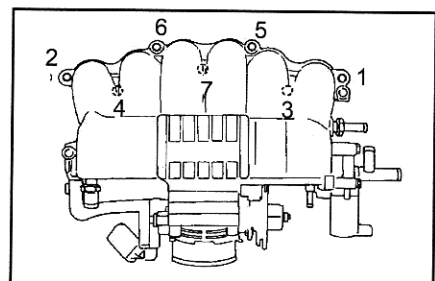

RB20E ENGINE

Installation

1. Install the collector bolts.
- Install the bolts in the order shown in the figure on the right uniformly in two to three stages.

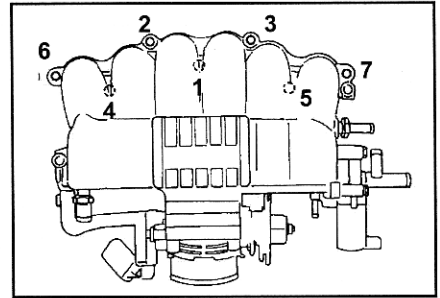

Disassembly

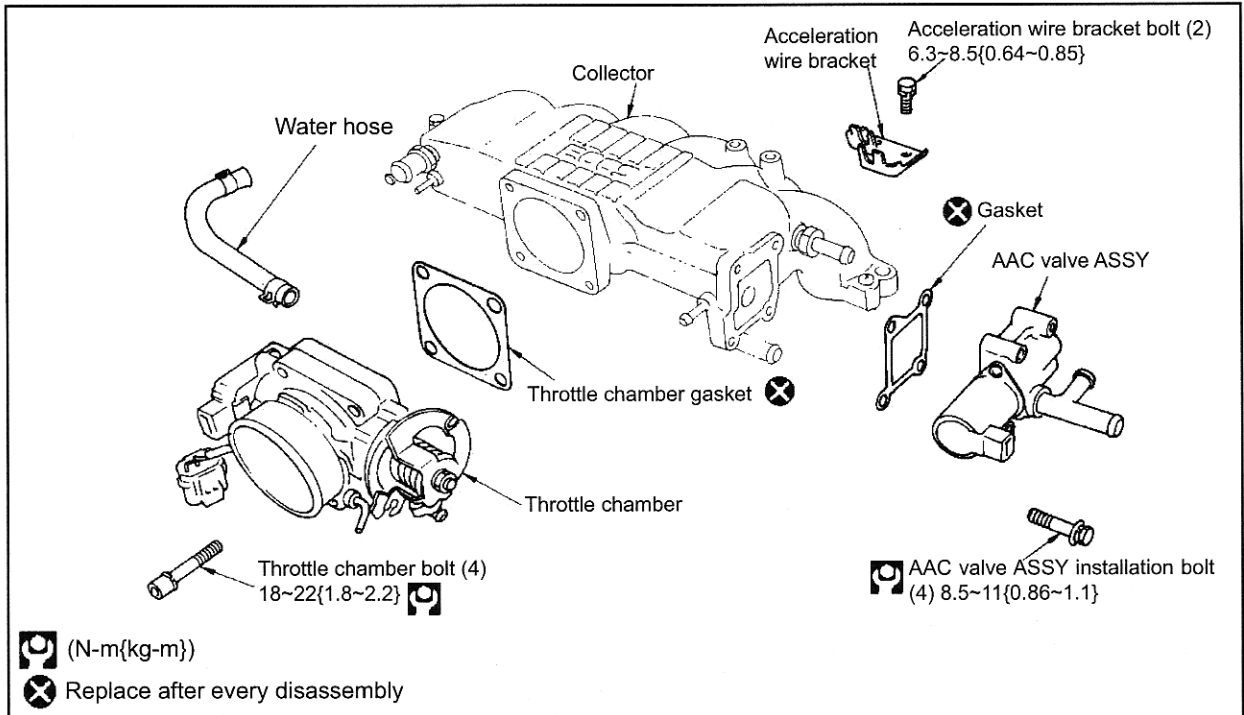

1. Remove throttle chamber bolts
- Remove the bolts in the order shown in the figure on the right.

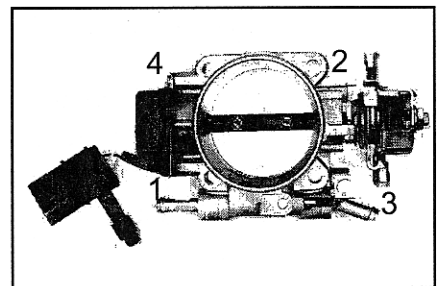

Assembly

1. Install the bolts in the order shown in the figure on the right uniformly in two stages.
Tightening torque (N-m{kg-m})

1st stage	9~11{0.9~1.1}
2nd stage	18~22{1.8~2.2}
2. Install the throttle chamber gasket.
 - When installing the throttle chamber gasket, make sure to install it in the correct direction.

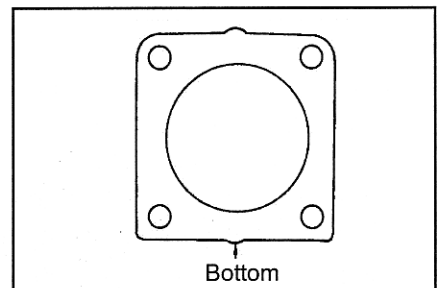

12. OIL PUMP

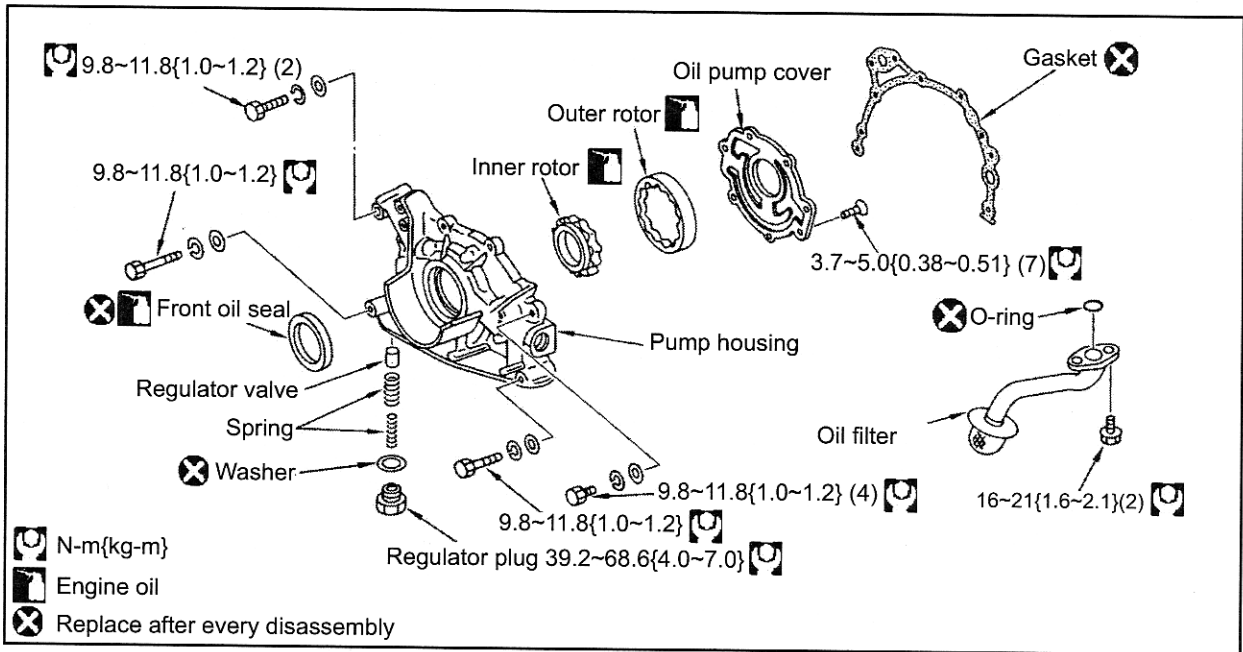
**Removal**

1. Remove the battery negative terminal.
 - (1) Open the boot lid.
 - (2) Remove the boot front finisher and remove the negative battery terminal.
2. Remove the under cover.
3. Drain coolant from the radiator drain plug.
4. Drain the engine oil from the oil pan.
5. Remove the air duct (external air introduction side).
6. Remove the cooling fan.
7. Remove the radiator.
8. Remove auxiliary belt.
9. Remove the timing belt.
10. Remove the crank timing pulley.
11. Remove the timing belt rear cover.
12. Remove the oil pan.
13. Remove the oil pump.

Installation

1. Install the oil pump.
 - Use the scraper to remove old gasket from the oil pump and the cylinder block.
 - Use white gasoline to remove grease, water and rubbish from the installation surface.
 - Replace the gasket with a new one.
 - Align to the knock pin on the cylinder block side to install.
 - There are four types of oil pump installation bolts. Make sure to use the correct bolts.

RB20E ENGINE

Installation position	Number	Installation bolt length below head (mm)
1	4	20
2	2	35
3	1	45
4	1	55

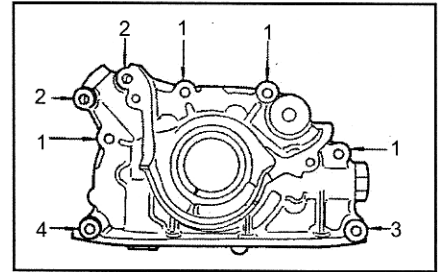

Tightening torque (N-m{kg-m}) 9.8~11.8{1.0~1.2}

2. Install the rest in reverse order to the removal procedure.

Disassembly

1. Remove the front oil seal.
 - Use a tool such as a screwdriver to remove.

Caution:

Care must be taken not to damage the oil pump housing.

2. Remove the oil pump cover.
3. Remove the inner and outer rotor.
4. Disconnect the regulator plug and remove the spring and the regulator valve.

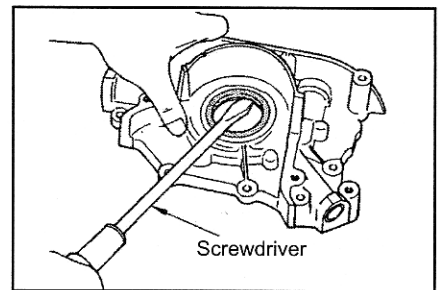

Inspection

Oil pump visual inspection

- Check for any wear or damage on the inner and outer rotor and the oil pump housing.
- Replace the oil pump ASSY if there is any abnormality.

Oil pump parts clearance inspection

- Use the feeler gauge to check the following clearance.
 - (1) Outer rotor to oil pump housing clearance
Standard value (mm) 0.11~0.2
 - (2) Outer rotor and inner rotor chip clearance.
Standard value (mm) Below 0.180
 - (3) Inner rotor to oil pump housing side clearance
Standard value (mm) 0.05~0.07
 - (4) Outer rotor to oil pump housing side clearance
Standard value (mm) 0.05~0.11
- Replace the oil pump ASSY if any of the measurements are out of standard value.

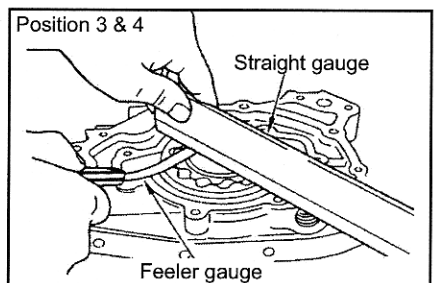
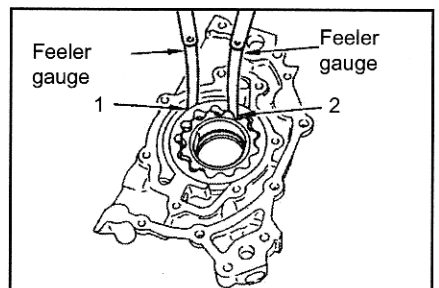

RB20E ENGINE

- (5) Inner rotor to oil pump housing inlow area clearance
- Use the method below to measure the clearance between the inner rotor and oil pump housing inlow area.
 - Use the micrometer to measure the oil pump housing inlow inner diameter.

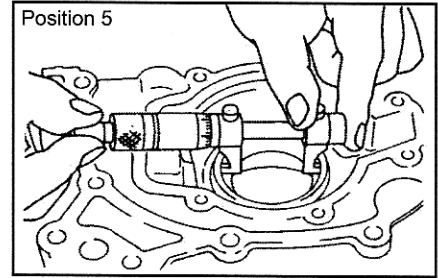

- (6) Use the micrometer to measure the inner rotor inlow outer diameter.

$$\begin{aligned} \text{(Inner rotor to oil pump housing inlow area clearance)} &= \\ &= \text{(Oil pump housing inlow inner diameter)} - \\ &= \text{(Oil pump housing inlow outer diameter)} \end{aligned}$$

Standard value (mm) 0.045~0.091

- Replace the oil pump ASSY if the measurements are out of standard value.

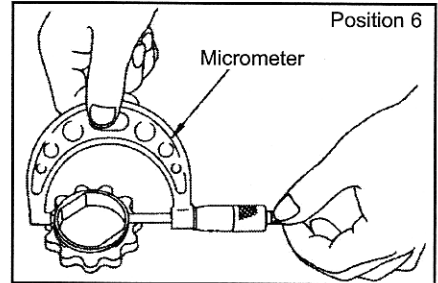

Regulator valve visual inspection

- Check for any wear or damage on the regulator valve rotational parts.
- Check the regulator spring for any abnormality.
- Replace the regulator valve or the oil pump ASSY if there are any faults.

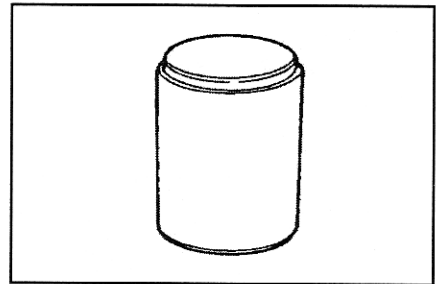
**Assembly**

1. Install the inner and the outer rotor.
 - Apply engine oil to each rotational and moving parts.
 - Position the inner rotor groove to the cover side.
2. Tighten the oil pump cover installation screws equally.

Tightening torque (N-m{kg-m}) 3.7~5.0{0.38~0.51}
3. Install the regulator valve.
 - Apply engine oil to rotational parts.
 - Replace the regulator washer with a new one.
 - Tighten the regulator plug.

Tightening torque (N-m{kg-m}) 39~69{4.0~7.0}
4. Install the front oil seal.
 - Replace the oil seal with a new one.
 - Check if there is any damage or deformation on oil seal periphery.
 - Position the oil seal side with writing towards front.
 - Use the oil seal drift to insert the oil seal in until level with installation surface.
 - Apply engine oil or chassis grease to oil seal lip surface.

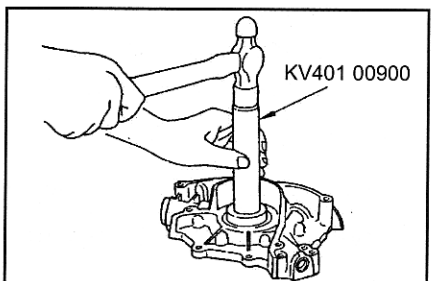
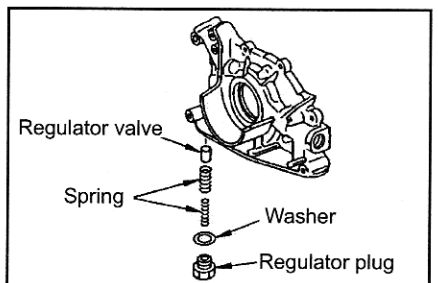
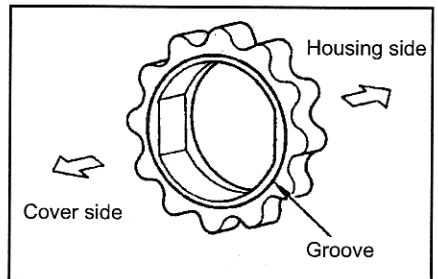

13. COOLING FAN

Removal

1. Remove the battery negative terminal inside the boot.
2. Remove the air duct.
3. Loosen the cooling fan installation nuts.
4. Loosen the fan belt.
5. Remove the installation nuts to remove the cooling fan.
6. Remove the installation bolts to remove the fan from the cup ring.

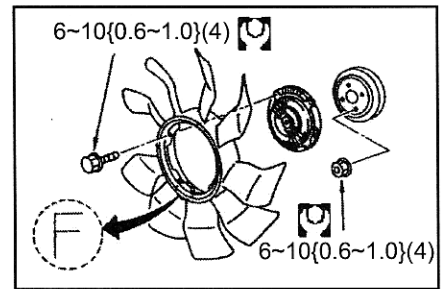

Inspection

Cup ring inspection

- Check for any silicon oil leak.

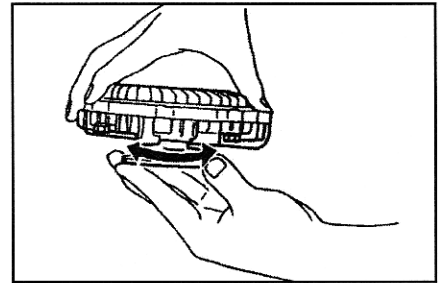

Cooling fan inspection

- Check for any damage or cut.

Installation

Install parts in the reverse order to the removal procedure.

- Install the fan to the cup ring making sure the front mark is facing front.
Tightening torque (N-m{kg-m}) 6~10{0.6~1.0}
- Adjust the fan belt tension.

RB20E ENGINE

14. WATER PUMP

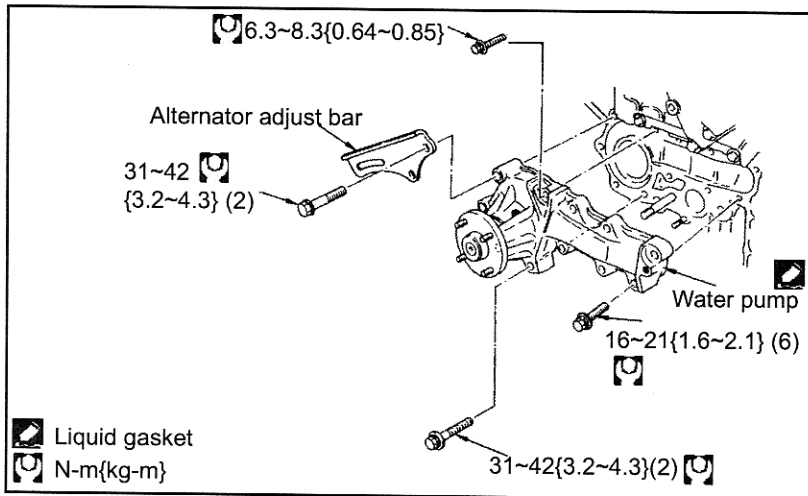
**Removal**

1. Remove the battery negative terminal inside the boot.
- (1) Open the boot lid.
- (2) Remove the boot front finisher and remove the negative battery terminal.
2. Remove the air duct.
3. Remove the under cover.
4. Drain coolant from the radiator drain plug.
5. Drain coolant from the cylinder block drain plug.
6. Remove the cooling fan.
7. Remove the radiator.
8. Remove the auxiliary belt.
9. Remove the water pump pulley.
10. Remove the timing belt.
11. Remove the tensioner pulley.
12. Remove the alternator adjust bar.
13. Remove the installation bolts in the order shown.
14. Remove the water pump.

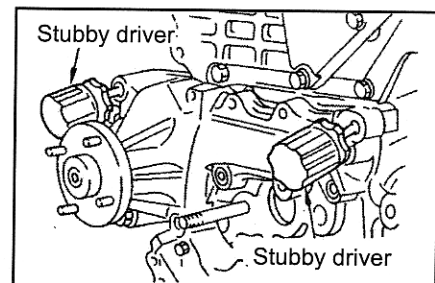
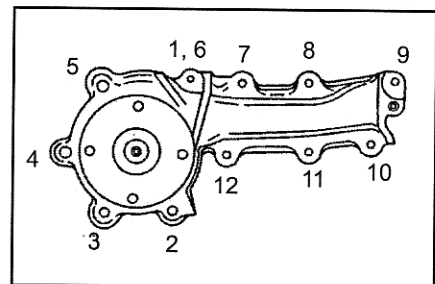

- Insert a stubby driver into the installation bolt hole and move it up and down to remove.

Caution:

Care must be taken not to damage the cylinder block side screws.

RB20E ENGINE

Inspection

- Check the water pump main body and the vane for rust or foreign objects.
- Make sure the water pump is not warpy.
- Replace the water pump if there is any abnormality.

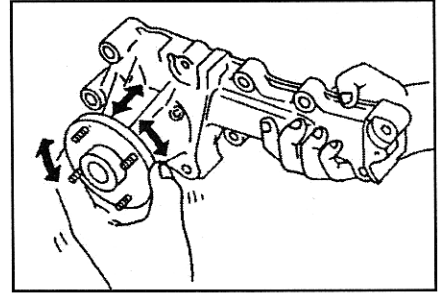

Installation

1. Install the water pump.
 - Use a scraper to remove old gasket from the water pump and the cylinder block installation surface.
 - Clean the installation surface with white gasoline.
 - Apply sealing agent (KP710 00150) to the position shown in approx. $\Phi 2.0\sim 3.0\text{mm}$.

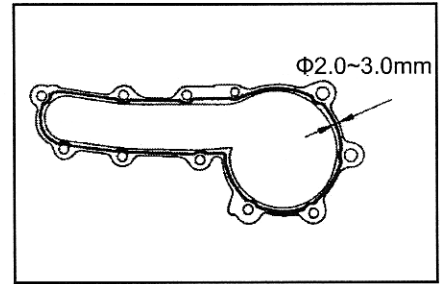

- Tighten the installation bolts in the order shown.
- Tighten the installation bolts 8 and 9 together with the alternator adjust bar.

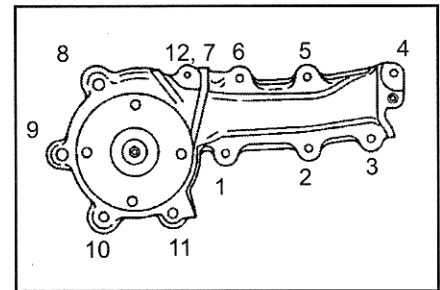

- There are four types of installation bolts.

Tightening torque (N-m{kg-m})

M6	6.3~8.3{0.64~0.85}
M8	16~21{1.6~2.1}
M10	31.4~42.1{3.2~4.3}

2. Install the rest in reverse order to the removal procedure.

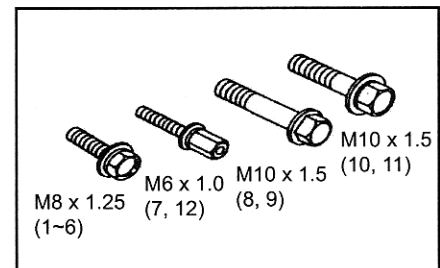

15. THERMOSTAT & WATER INLET

Removal

1. Remove the battery negative terminal inside the boot.
 - (1) Open the boot lid.
 - (2) Remove the boot front finisher and remove the negative battery terminal.
2. Drain coolant from the radiator drain plug.
3. Drain coolant from the cylinder block drain plug.
4. Remove the alternator belt to shift the alternator down.
5. Remove the alternator adjust bracket.
6. Remove the radiator lower hose at the thermostat housing side.

7. Remove the water inlet.
 - Insert end of a tool such as a screwdriver into the thermostat housing and move it up and down to remove.
8. Remove the thermostat.

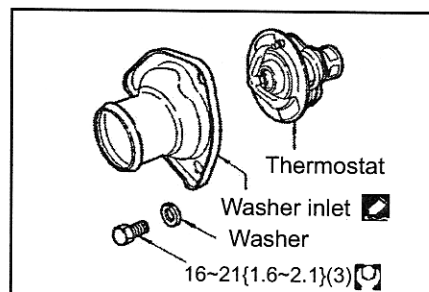

Inspection

Thermostat inspection

Check the valve opening temperature and maximum valve lift.

- Hang the thermostat by string to the valve and submerge in heated water in double walled container and stir water while heating it up.
- The opening temperature is the temperature when the valve opens and thermostat falls from the string.

Valve opening temperature (°C)	76.5
Max. valve lift (mm/°C)	Over 10 / 90
- Replace the thermostat if the value is not at standard value.

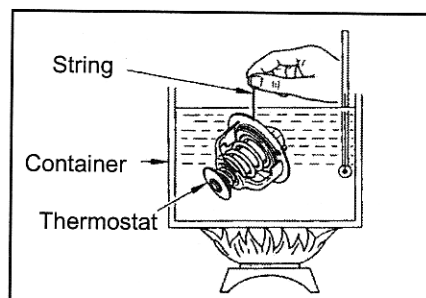

Installation

1. Use a scraper to remove old liquid gasket from the water inlet and the cylinder block installation surface.
 - Use white gasoline to clean the surface.
2. Install the thermostat.
 - Position the thermostat so the jiggle valve (TOP mark) is on the top.

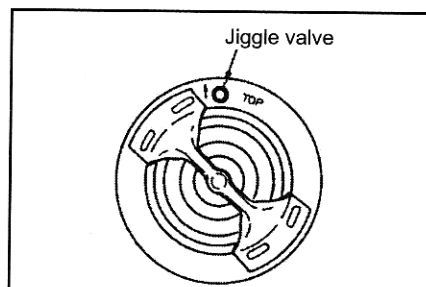

RB20E ENGINE

3. Install the water inlet.

- Apply sealing agent (KP510 00150) at approx. $\Phi 2.0\sim 3.0\text{mm}$ as shown in the figure on the right.

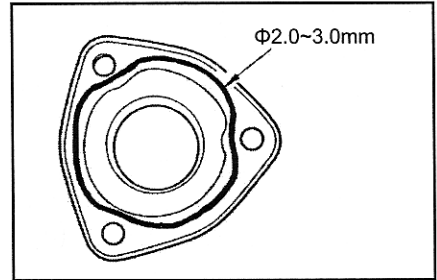

- Install in position as shown.
- Tighten the installation bolts.
Tightening torque (N-m{kg-m}) 16~21{1.6~2.1}

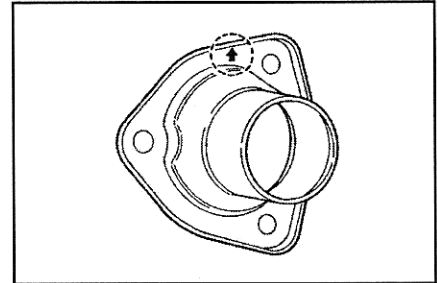

- 4. Install the rest in reverse order to the removal procedure.

16. WATER OUTLET

Removal

1. Remove the battery negative terminal inside the boot.
 - (1) Open the boot lid.
 - (2) Remove the boot front finisher and remove the negative battery terminal.
2. Drain coolant from the radiator drain plug.
3. Remove the radiator upper hose at the water outlet side.

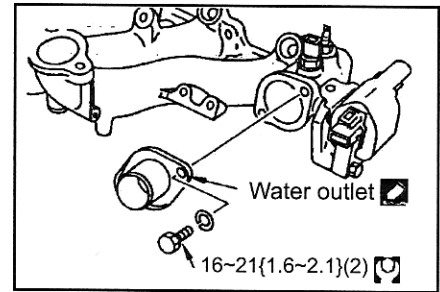

4. Remove the water outlet.
 - Insert end of a tool such as a screwdriver into the water outlet and move it up and down to remove.

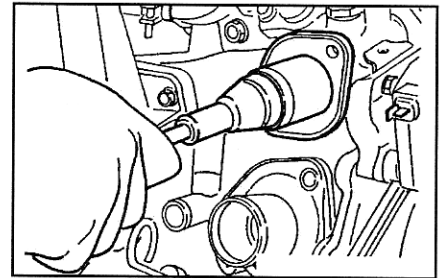

Inspection

Visual inspection

- Check the water outlet for any deformation or wear.
- Replace the water outlet if there is any abnormality.

Installation

1. Use a scraper to remove old liquid gasket on the water outlet and intake manifold installation surface.
 - Use white gasoline to clean the installation surface.
2. Install the water outlet.
 - Apply sealing agent (KP510 00150) at $\Phi 2.0\sim 3.0$ mm and install the water outlet.

Tightening torque (N-m{kg-m}) 16~21{1.6~2.1}
3. Install the rest in reverse order to the removal procedure.

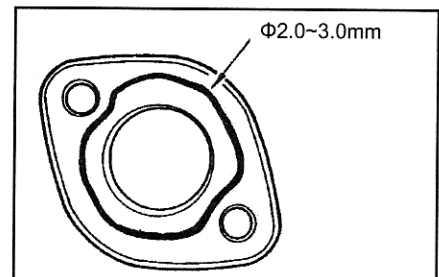

1. AIR CLEANER & AIR DUCT (RB25DE / RB25DET)

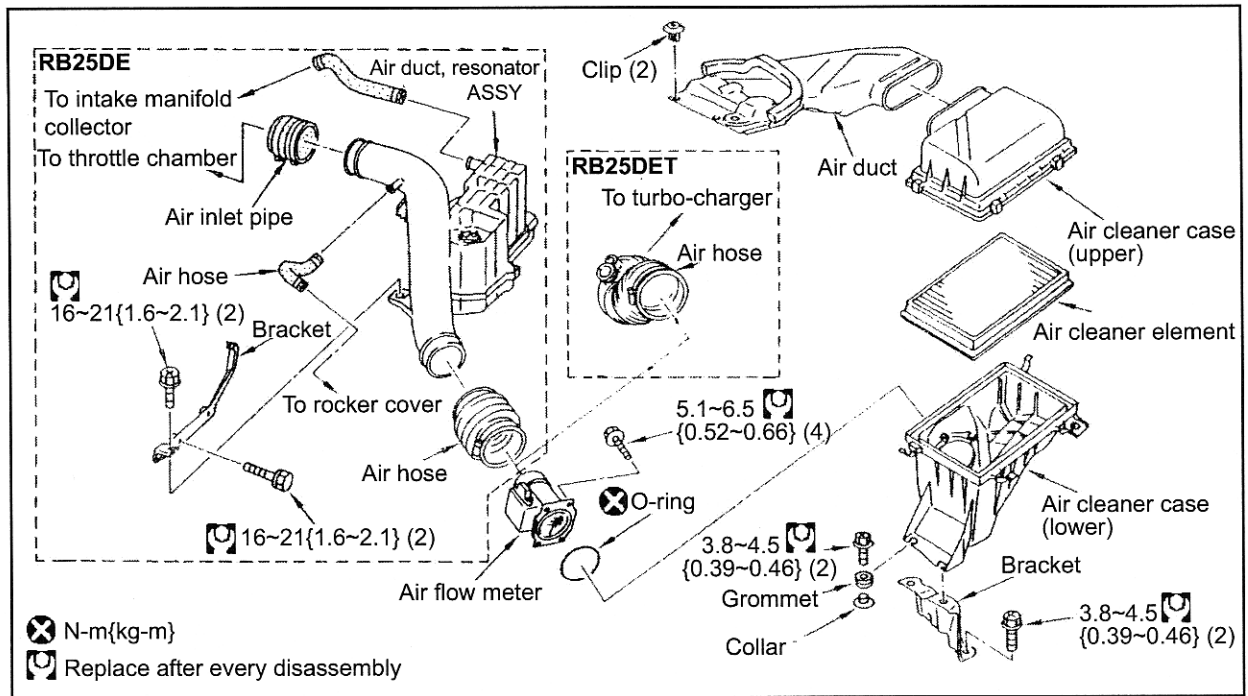

Removal

1. Remove negative battery terminal.
 - (1) Open the boot lid.
 - (2) Remove the boot front finisher and remove the negative battery terminal.
2. Before removing, use air gun to remove any rubbish, dust etc. to avoid foreign objects entering the duct.
3. Remove the air flow meter connector.
4. Remove the air duct, air cleaner case (upper) and air cleaner element.
 - Remove 2 air duct clips and 4 air cleaner case (upper) clips.
5. Remove the air cleaner case (lower).
 - Remove 4 installation bolts.
6. Remove the air duct, resonator ASSY (RB25DE).
 - Remove 2 air hoses, and installation bolts.
7. Remove the air hose (RB25DET).
 - (1) Remove the air inlet tube.
 - Remove 3 installation bolts.
 - (2) Remove power steering reservoir tank installation bolts and shift it towards front.

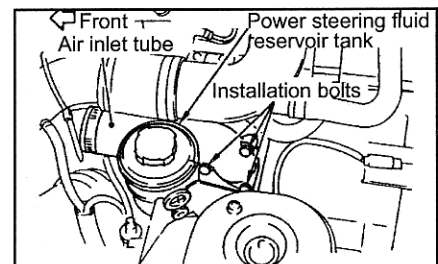
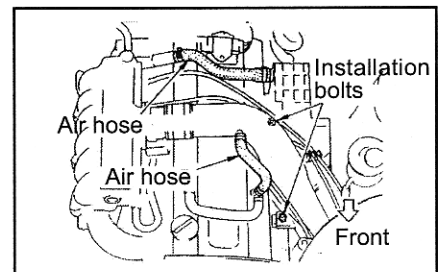
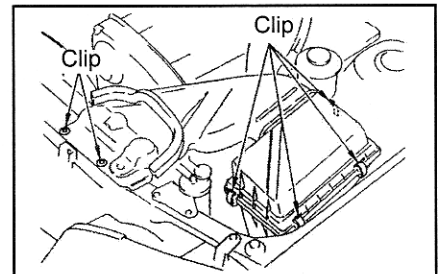
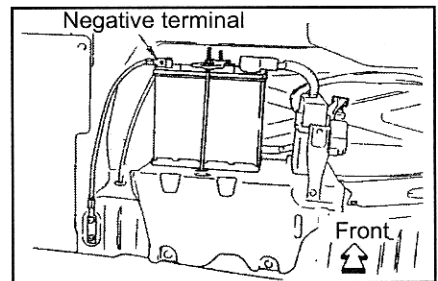

RB25DE / RB25DET ENGINE

- (3) Remove air tube from the air hose.
- (4) Remove air hose clamp to take out the air hose.

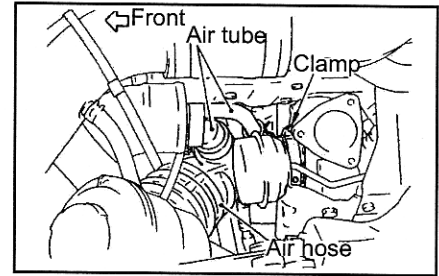
**Inspection**

- Make sure the air cleaner element is clean.
Periodic replacement period: Every 60,000km

Installation

1. Install the air hose (RB25DET).
 - Make sure the clamp is facing correct direction when installing.
2. Install the air duct and resonator ASSY (RB25DE).
 - Tighten 2 installation bolts.
Tightening torque (N-m{kg-m}) 16~21{1.6~2.1}
 - Install 2 air hoses.
3. Install the lower air cleaner case.
 - Tightening torque (N-m{kg-m}) 3.8~4.5{0.39~0.46}
4. Install the air cleaner element, air cleaner case (upper) and the air duct.
 - Place 4 air cleaner case (upper) clips and 2 air duct clips.
5. Install the rest in reverse order to the removal procedure.
 - When the air flow meter is removed, replace the o-ring at installation.

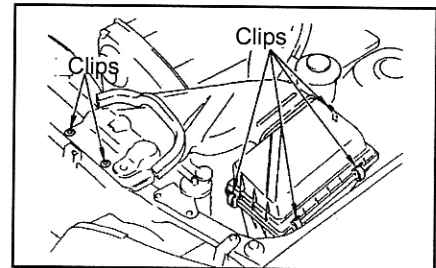
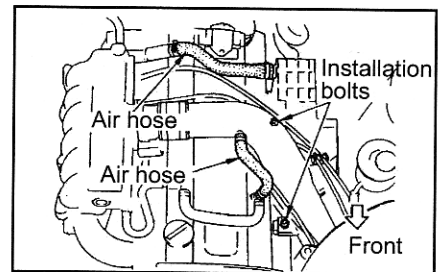

2. INTAKE MANIFOLD COLLECTOR

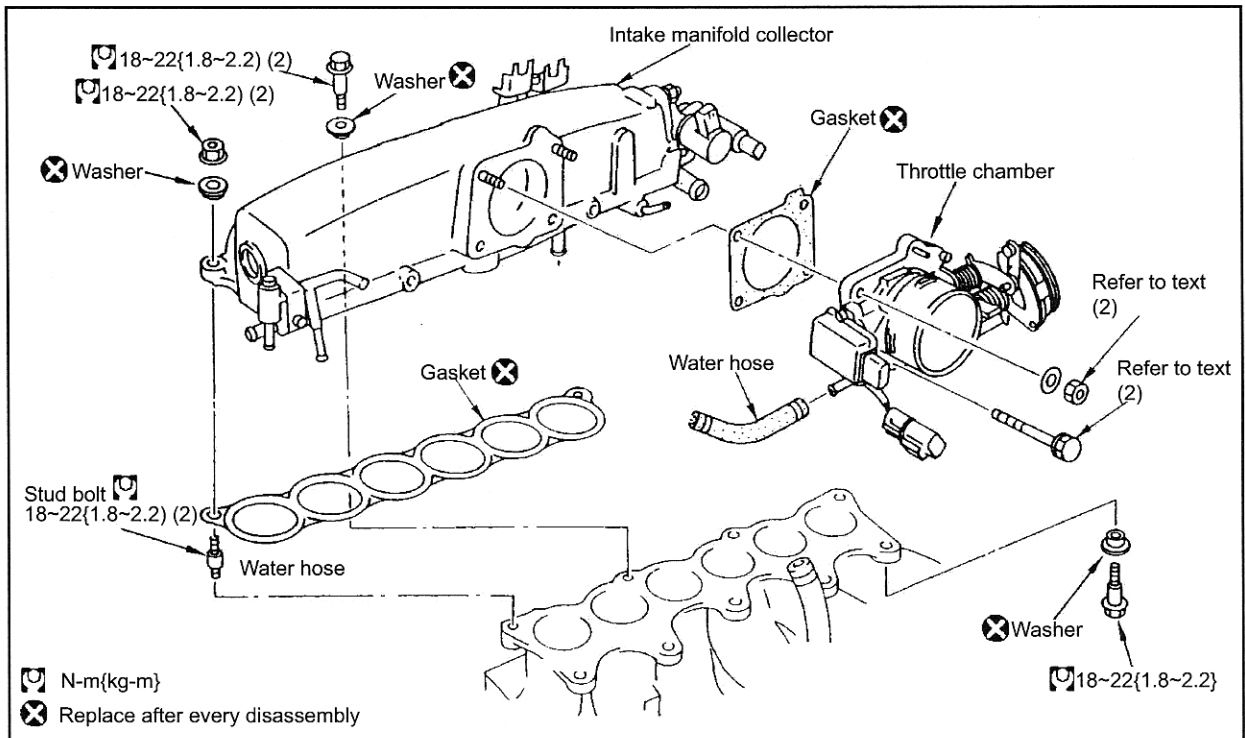

Removal

1. Remove the negative battery terminal.
 - (1) Open the boot lid.
 - (2) Remove the boot front finisher and remove the negative battery terminal.
2. Drain coolant from the radiator drain plug.
3. Remove the air duct and the resonator ASSY.
4. Remove the air inlet pipe.
5. Disconnect the accelerator wire and the ASCD wire.
6. Remove the throttle sensor, throttle valve switch, AAC valve and FICD connector.
7. Disconnect the water vacuum, blow-by and air hoses on the intake manifold collector.
8. Remove the throttle chamber ASSY.
 - Remove the installation bolts in the order shown.
 - Remove the gasket.
9. Remove the intake manifold collector ASSY.
 - Remove the installation nuts and bolts in the order shown in the figure to the right.
 - Check if you have removed all hoses and wires.
10. Remove the gasket.

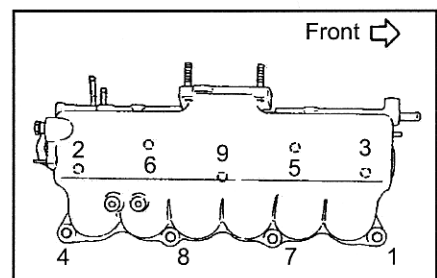
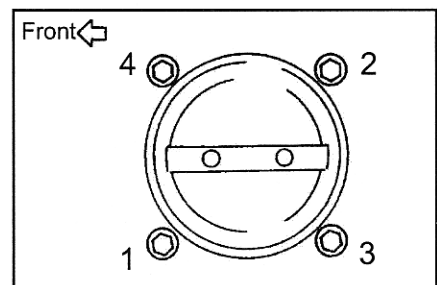

Inspection

Distortion of the intake manifold collector

- Use the straight gauge and the feeler gauge to measure the distortion in six directions.
Limit value (mm) 0.1
- If the distortion is over the limit use the surface grinder to repair distortion. Replace the intake manifold collector if the distortion is too excessive to fix.

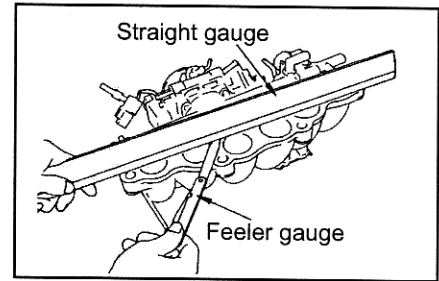

Installation

1. Install the gasket.
 - Replace the gasket with a new one.
 - Remove any fluid, grease, rubbish etc. adhered to installation surface.
2. Install the intake manifold collector ASSY.
 - Tighten installation nuts and bolts in several stages in order shown.

Tightening torque (N-m{kg-m}) 18~22{1.8~2.2}

Caution:

Install 1, 4, 5, and 7 installation bolts from below intake manifold.

No. 6 and 9 is a stud bolt and nut.

3. Install intake manifold collector hoses.

4. Install the throttle chamber.

(1) Make sure there are no grease or rubbish on the gasket and installation surface.

(2) Install the gasket.

- Replace the gasket with a new one.

(3) Install the bolts in the order shown in two stages.

Tightening torque (N-m{kg-m})

1 st 8.8~11{0.9~1.1}

2 nd 18~21{1.8~2.1}

5. Install each pipes according to the diagram on the following page.

- The diagram shows the reverse side of the intake manifold collector.

6. Install the rest in reverse order to the removal procedure.

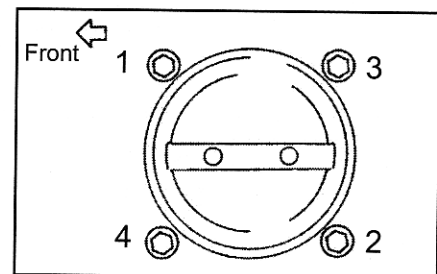
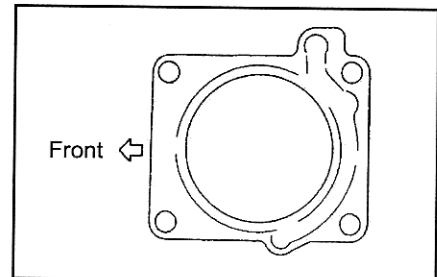
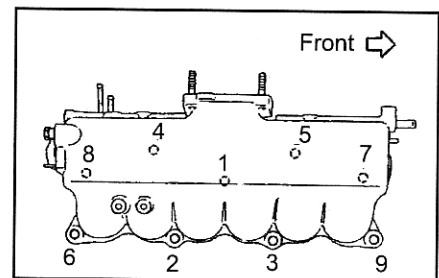

RB25DE / RB25DET ENGINE

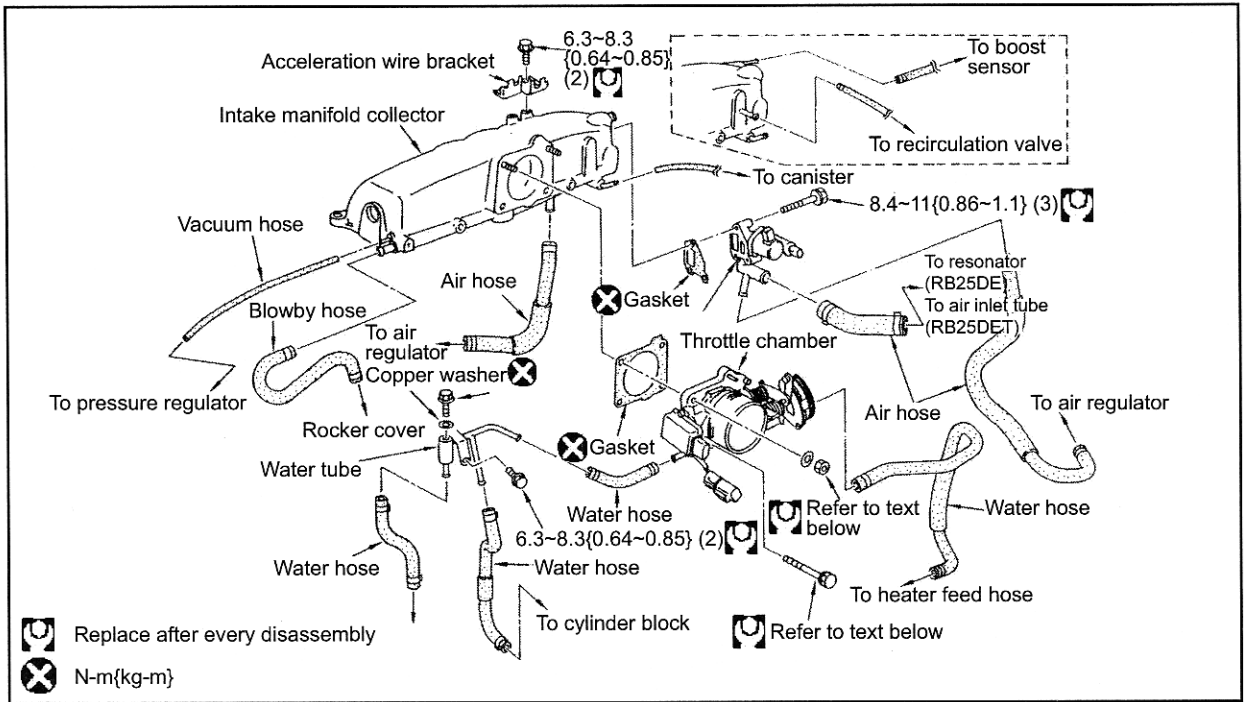

Disassembly

1. Remove the IAA unit.

Caution:

Do not disassemble IAA unit.

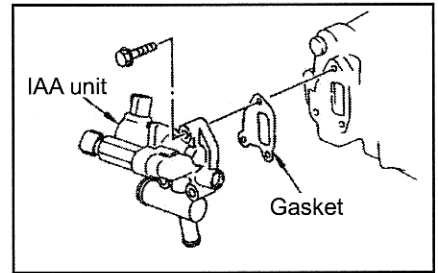

Assembly

1. Install the IAA unit.
 - Replace the gasket with a new one.
 - Make sure there are no grease or rubbish on the gasket and installation surface.

Tightening torque (N-m{kg-m}) 8.4~11{0.86~1.11}

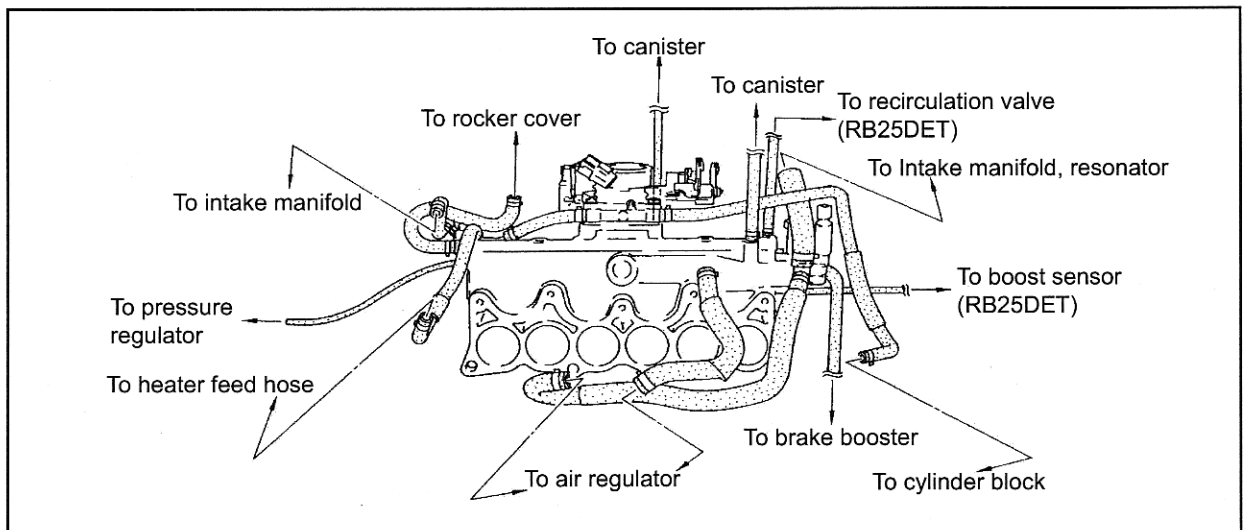

3. FUEL INJECTOR

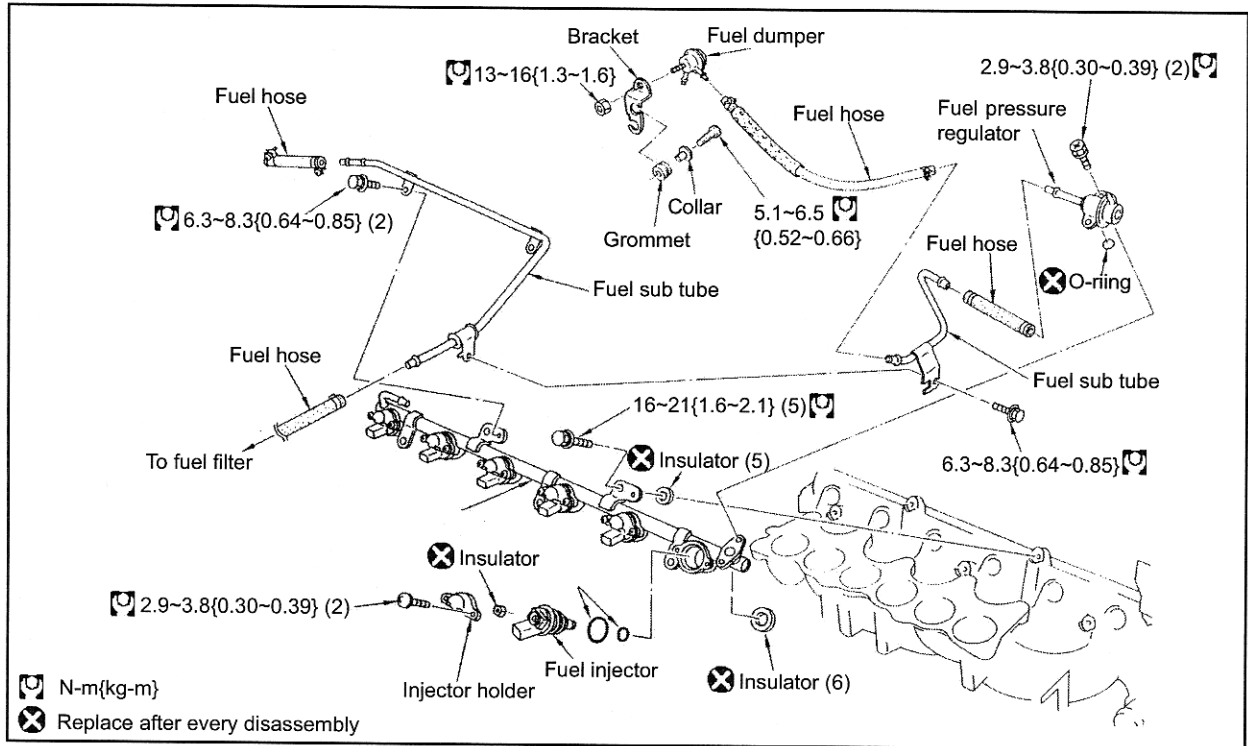

Removal

1. Release the fuel pressure.
2. Remove the battery negative terminal.
 - (1) Open the boot lid.
 - (2) Remove the boot front finisher and remove the negative battery terminal.
3. Drain coolant from the radiator drain plug.
4. Remove air duct and resonator ASSY.
5. Remove air inlet pipe.
6. Remove intake manifold collector ASSY.
7. Remove fuel tube and fuel injector ASSY.
 - (1) Remove fuel feed and the return hose.
 - Place a hole cap immediately after removing the fuel hose to avoid fuel leak.
 - (2) Disconnect the fuel injector harness connector.
 - (3) Remove fuel tube installation bolts.
 - (4) Remove fuel tube installation bolts in order shown in the diagram on right.
8. Remove the fuel pressure regulator.

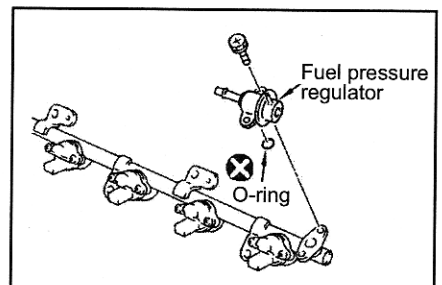
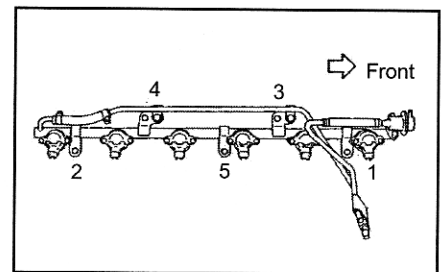

Caution:

Fuel remaining in the fuel tube may leak.

9. Remove fuel injector from the fuel tube.
 - (1) Remove the injector hose.
 - (2) Remove the fuel injector by pushing from nozzle side.
 - Do not hold the connector parts.
 - Care must be taken not to drop them.

Caution:

Do not disassemble the fuel injector.

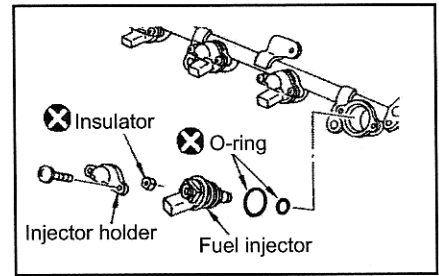
**Inspection****Fuel tube & fuel hose**

- Check to make sure the fuel is not leaking from the fuel tube and the fuel hose.
- Replace the parts if there are any abnormalities.

Installation

1. Install fuel injector to the fuel tube.
 - (1) Install o-ring to fuel injector.
 - Replace o-ring with a new one.
 - Read the handling note before carrying out the operation.

Handling note

- Always handle the O-ring with bare hands (no gloves).
- Only apply engine oil (7.5W-30 or similar viscosity) and never clean or soak the o-ring in solvent solution.
- Avoid using dirty o-ring and devices with dust or other foreign objects adhered to it.
- When installing the o-ring care must be taken not to scratch the o-ring with tools or nails. Also do not twist or stretch them.
- When inserting the fuel injector, pressure regulator or fuel dumper into the fuel tube, do not twist or turn the parts.

- (2) Install the fuel injector to fuel tube.
 - Care must be taken not to damage the nozzle tip.

Note:

If it is difficult to install the fuel injector due to o-ring resistance, first install the injector holder and use a screw with under head approx. 30mm to tighten up alternately to insert the fuel injector.

Tightening torque (N-m{kg-m}) 2.9~3.8{0.30~0.39}

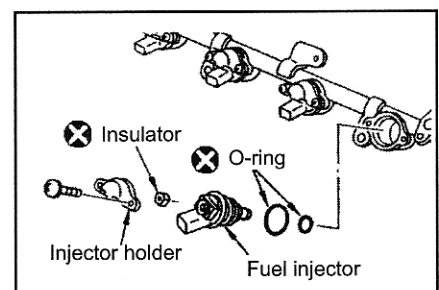

RB25DE / RB25DET ENGINE

2. Install the fuel pressure regulator.
 - Replace the o-ring with a new one.
Tightening torque (N-m{kg-m}) 2.9~3.8{0.30~0.39}
3. Install fuel tube and fuel injector ASSY.
 - (1) Install fuel sub tube to the fuel tube.
Tightening torque (N-m{kg-m}) 6.3~8.3{0.64~0.85}
 - (2) Tighten the fuel tube installation bolts in the order shown in two stages.
Tightening torque (N-m{kg-m}) 16~21{1.6~2.1}
 - Replace the insulator with a new one.
4. Install the fuel injector connectors.
5. Install the fuel feed and return hose.
 - Insert the hose tip up to the second bulged part of the fuel tube and make sure to securely tighten the clamp.
6. Install the rest in reverse order to the removal procedure.
7. Place the ignition switch to the ON position to place fuel pressure to fuel pipings to check for any fuel leak.

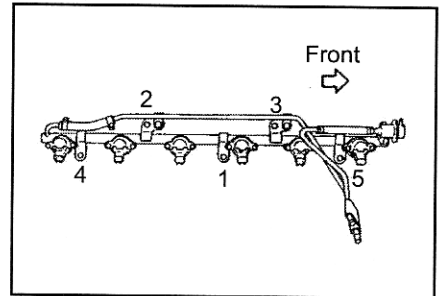
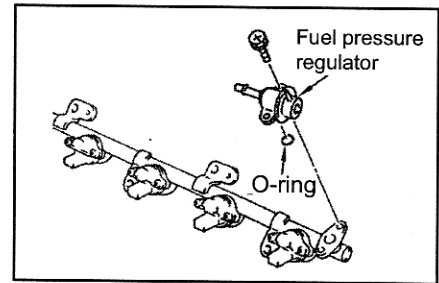

4. INTAKE MANIFOLD

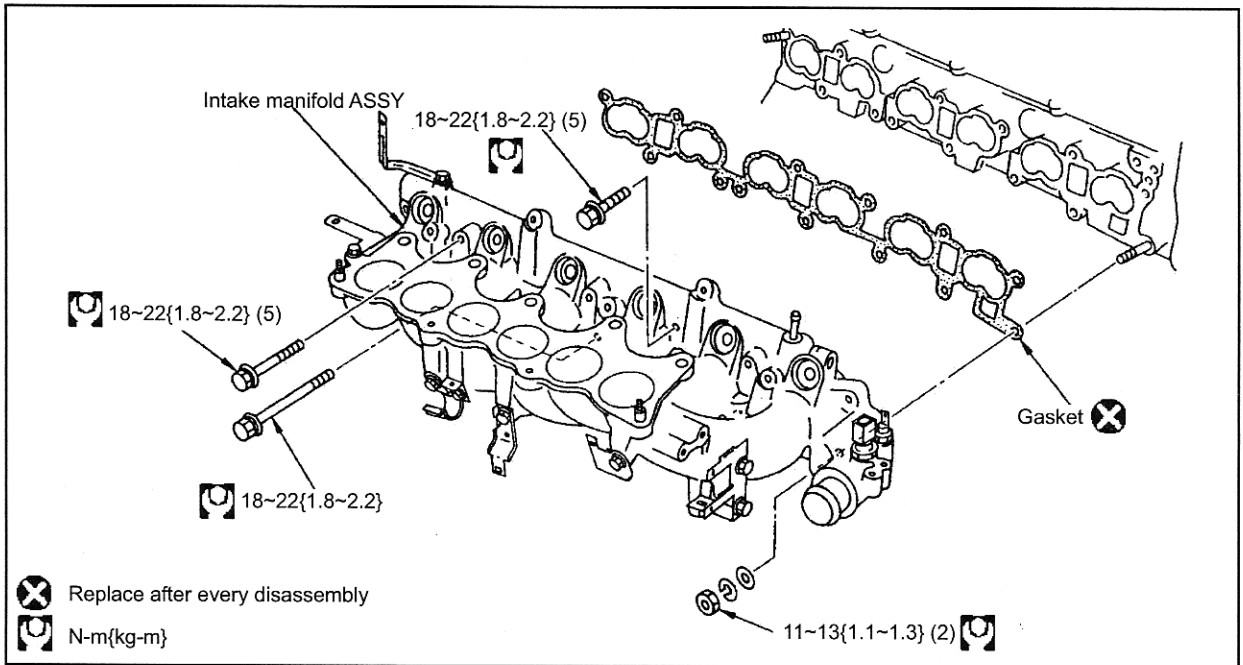

Removal

1. Release the fuel pressure.
2. Remove the battery negative terminal.
 - (1) Open the boot lid.
 - (2) Remove the boot front finisher and remove the negative battery terminal.
3. Drain coolant from the radiator drain plug.
4. Drain coolant from the cylinder block drain plug.
5. Remove air duct and resonator ASSY.
6. Remove the air inlet pipe.
7. Remove the intake manifold collector ASSY.
8. Remove the fuel injector ASSY.
9. Remove the radiator hose (upper).
10. Disconnect thermal transmitter connector.
11. Disconnect engine coolant temperature sensor connector.
12. Disconnect VTC solenoid connector.
13. Remove ground terminals (2).
14. Disconnect air regulator connector.
15. Remove the oil level gauge guide installation bolt.
16. Remove the intake manifold ASSY.
 - (1) Remove installation bolts and nuts in order shown in the figure on the right.
 - (2) Remove each water hose below intake manifold. (RB25DET).
17. Remove the gasket.

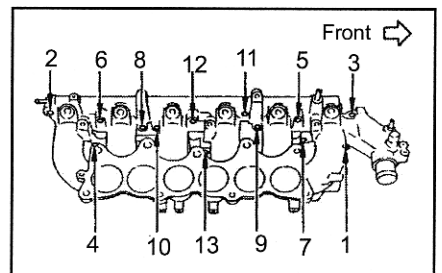
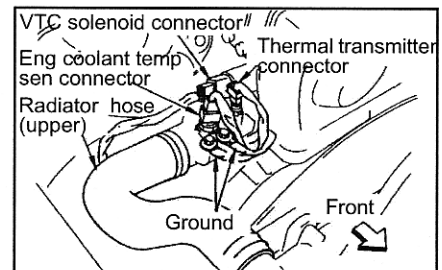

Inspection

Distortion of the intake manifold

- Use the straight gauge and the feeler gauge to measure the distortion of the front and reverse surface in six directions.
Limit value (mm) 0.1
- If the distortion is over the limit use the surface grinder to repair distortion. Replace the intake manifold if the distortion is too excessive to fix.

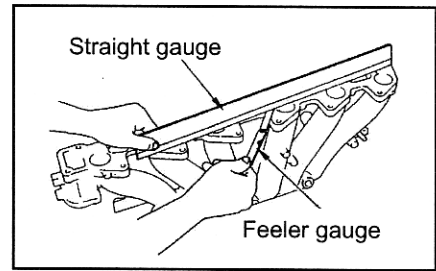

Installation

1. Install the gasket.
 - Use a scraper to remove any gasket or foreign objects etc. adhered to intake manifold and cylinder head installation surface.
 - Replace the gasket with a new one.
2. Install intake manifold ASSY.
 - (1) Install each water hoses below intake manifold (RB25DET).
 - (2) Install the bolts and nuts in the order shown in figure on the right.

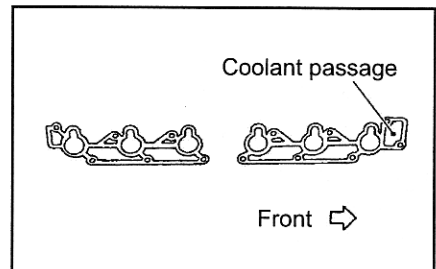

Tightening torque (N-m{kg-m})

Bolt 18~22{1.8~2.2}
Nut 11~13{1.1~1.3}

Installation position	Bolt			Nut
	3, 4, 5, 6, 11	2, 7, 8, 9, 10	1	12, 13
Bolt under head length (mm)	40	65	95	-

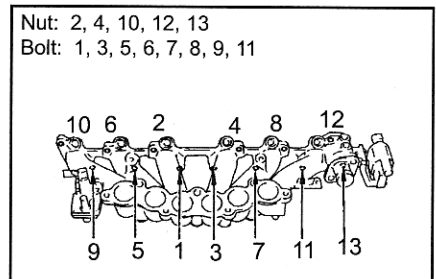

3. Install the oil level gauge guide installation bolt.
Tightening torque (N-m{kg-m}) 3.9~4.9{0.4~0.5}
4. Install the air regulator connector.
5. Install the radiator hose (upper).
6. Connect the earth terminal.
7. Install the VTC solenoid connector.
8. Install the engine coolant temperature sensor connector.
9. Install the thermal transmitter connector.
10. Install the rest in reverse order to the removal procedure.

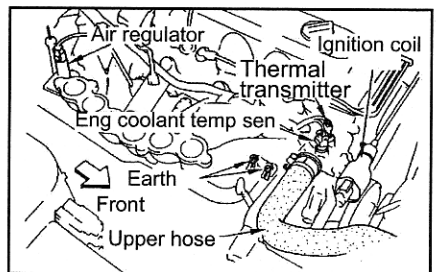

RB25DE / RB25DET ENGINE

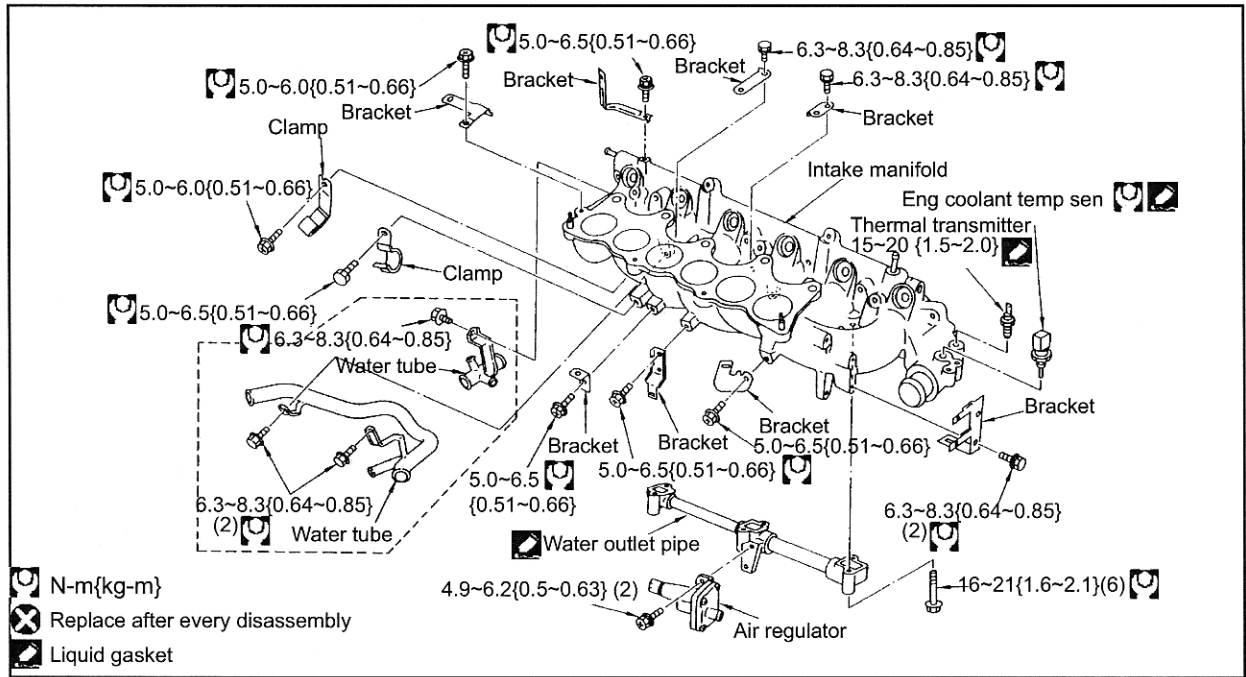

Disassembly

1. Remove the engine coolant temperature sensor and thermal transmitter.

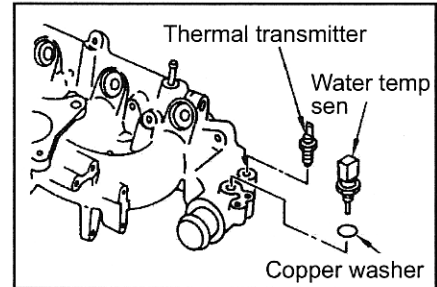

2. Remove each bracket and the clamps.
3. Remove the air regulator.

Caution:

- Do not disassemble and adjust the air regulator.
- Care must be taken not to damage parts by dropping tools.

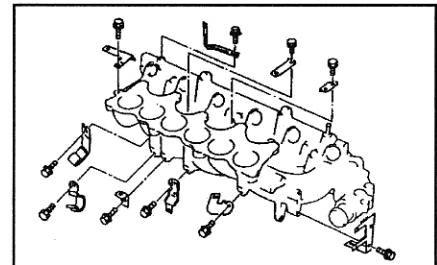

4. Remove water outlet pipe.
 - Place a screwdriver etc. between right and left water outlet pipe. Move it up and down gently to remove.
5. Remove the water tube. (RB25DET)

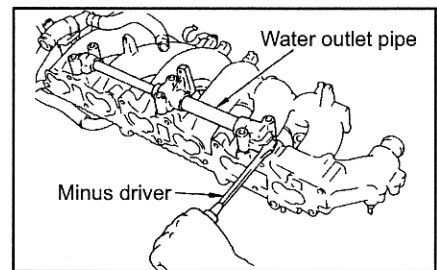

Assembly

1. Install the water tube (RB25DET)
Tightening torque (N-m{kg-m}) 6.3~8.3{0.64~0.85}

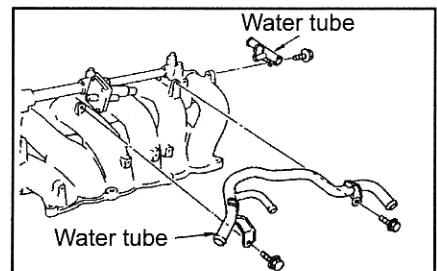

RB25DE / RB25DET ENGINE

2. Install water outlet pipe.

- (1) Use the scraper to remove gasket on water pipe installation surface and intake manifold side installation surface.
- (2) Apply sealing agent (KP510 00150) as shown in the figure on the right at approx. $\Phi 2.0 \sim 3.0$ mm.

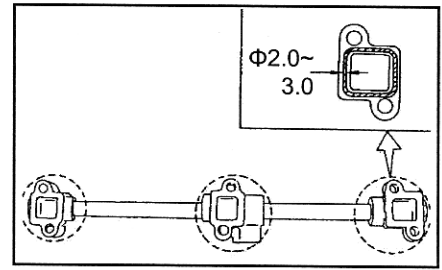

(3) Install the water outlet pipe to intake manifold.

- Make sure the front mark is facing the front when installing.

Tightening torque (N-m{kg-m}) 16~21{1.6~2.1}

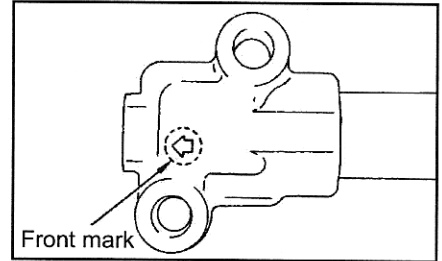

3. Install the air regulator.

Tightening torque (N-m{kg-m}) 4.9~6.2{0.5~0.63}

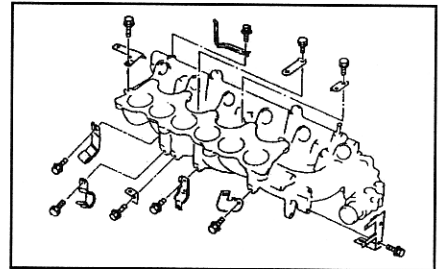

4. Install each bracket and the clamps as shown.

5. Install the engine coolant temperature sensor and thermal transmitter.

- Apply the sealing agent to thread part.

Tightening torque (N-m{kg-m})

Engine coolant temperature sensor 20~29{2.0~3.0}

Thermal transmitter 15~20{1.5~2.0}

- Replace the engine coolant temperature sensor copper washer with a new one.

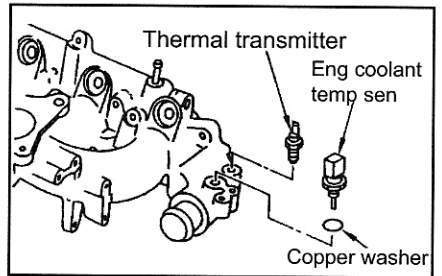

6. Install each pipings following the diagram below.

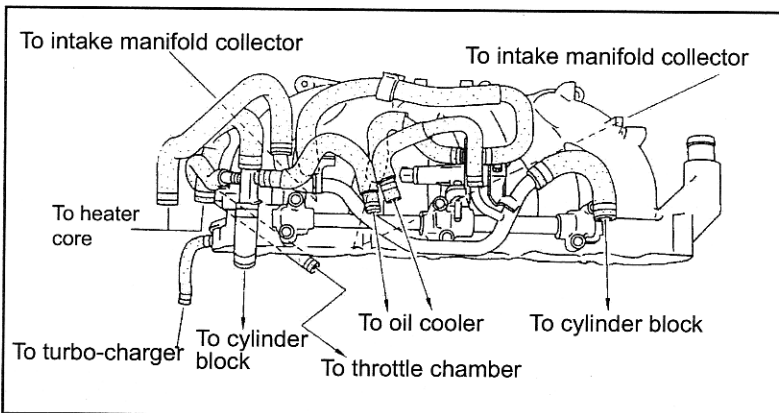

5. EXHAUST MANIFOLD

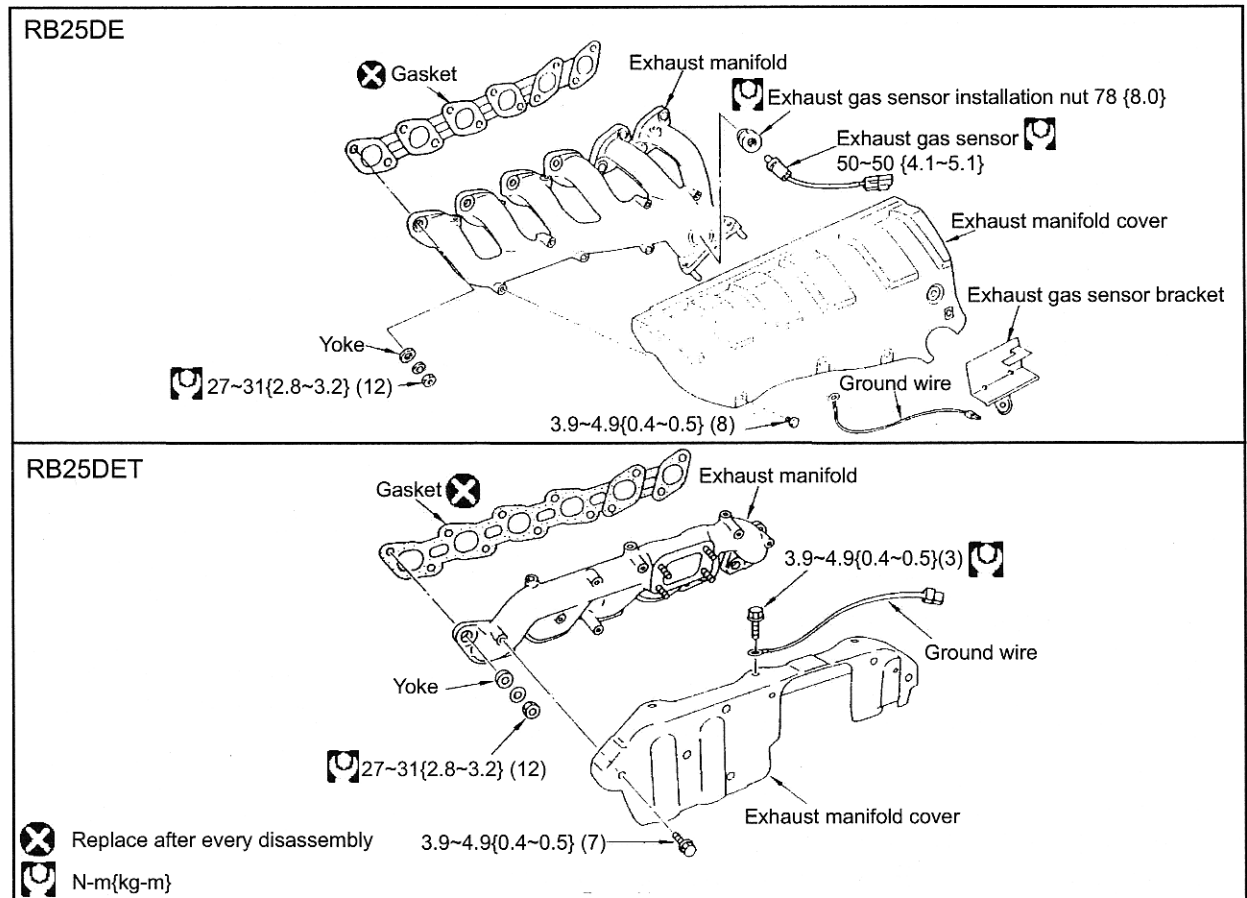

Removal

1. Remove the battery negative terminal.
 - (1) Open the boot lid.
 - (2) Remove the boot front finisher and remove the negative battery terminal.
2. Remove the under cover.
3. Remove the air duct and resonator ASSY.
4. Remove the air inlet pipe and air inlet hose (RB25DET).
5. Remove the air hose (RB25DET)
6. Remove the exhaust front tube from exhaust manifold (RB25DE), turbo-charger (RB25DET).
7. Disconnect the exhaust gas sensor connector.
8. Disconnect the earth wire between exhaust manifold and the body.
9. Remove the turbo-charger (RB25DET).
10. Remove exhaust manifold cover.
11. Remove exhaust gas sensor (RB25DE).
 - Use exhaust gas sensor socket remover to remove.

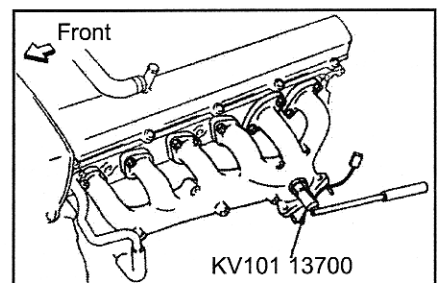

RB25DE / RB25DET ENGINE

12. Remove the exhaust manifold.

- Remove the installation nuts in the order shown in the figure on right.

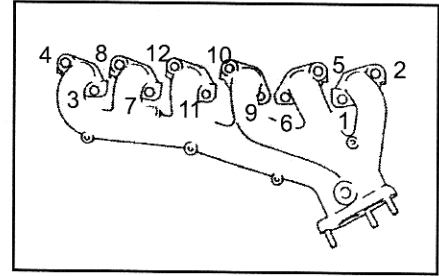

13. Remove the gasket.

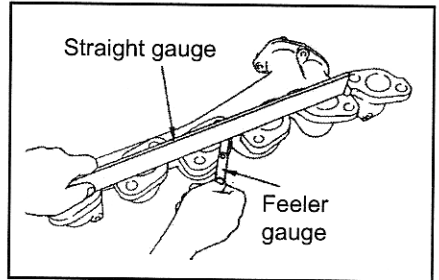
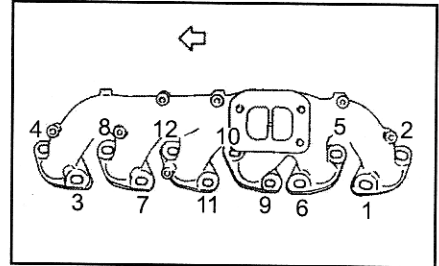
**Inspection**

Distortion of exhaust manifold

- Use the scraper to remove gasket on the installation surface.
- Use the straight gauge and the feeler gauge to measure the installation surface distortion in four directions.
Limit value (mm) 0.3
- If the distortion is over the limit use the surface grinder to repair distortion. Replace the exhaust manifold if the distortion is too excessive to fix.

Gas leak from the exhaust parts

- Look for any gas leak between the cylinder head side installation surface and exhaust front tube, (RB25DE), turbo-charger side installation surface (RB25DET).

Installation

1. Install exhaust sensor (RB25DE).

- Use exhaust sensor installation socket to install.

Caution:

Care must be taken not to cause any damage to exhaust gas sensor.

Tightening torque (N-m{kg-m})

Exhaust sensor installation nut	78{8.0}
Exhaust sensor	40~50{4.1~5.1}

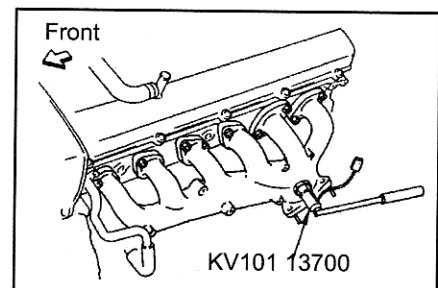

2. Install the stud bolt to cylinder head by placing the double nut.

Tightening torque (N-m{kg-m}) 27~31{2.8~3.2}

- Remove the double nut after installation.
- Replace the stud bolt with a new one.
- When installing the stud bolt, make sure the stud bolt with shorter thread side is on the cylinder head side.

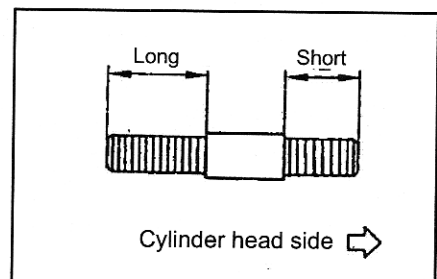

RB25DE / RB25DET ENGINE

3. Install the gasket.

- Use the scraper to remove gasket on the cylinder head and exhaust manifold installation surface.
 - Replace the gasket with a new one.
 - Make sure to install the gasket facing correct way.
- Tightening torque (N-m{kg-m}) 3.9~4.9{0.4~0.5}

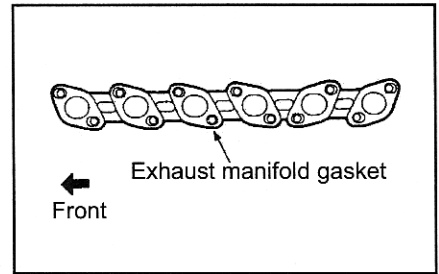

4. Install the exhaust manifold.

- Install the washer and the yoke.
- Make sure to place correct yoke when installing.

Exterior diameter ΦD (mm)

No.3 & No.4 port	22
No.1, No.2, No. 5 & No.6 port	24

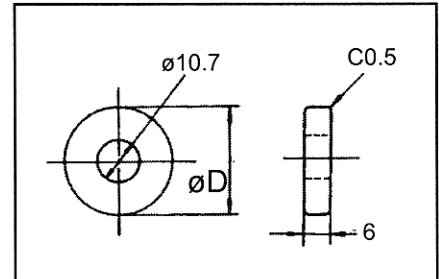

- Install the washer as shown.

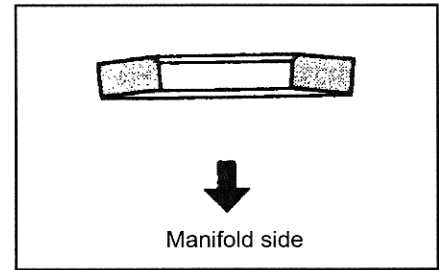

- Tighten the installation nuts in order shown in the figure on right.

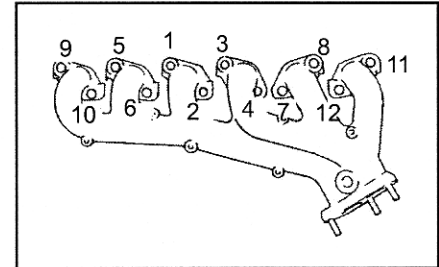

5. Install exhaust manifold cover.

Tightening torque (N-m{kg-m}) 3.9~4.9{0.4~0.5}

6. Install the turbo-charger (RB25DET).
7. Connect the earth wire between exhaust manifold and the body.
8. Install Exhaust gas sensor connector (RB25DE).
9. Install exhaust front tube.
10. Install the rest in reverse order to the removal procedure.
11. After installation is completed, start the engine and check for any exhaust gas leak.

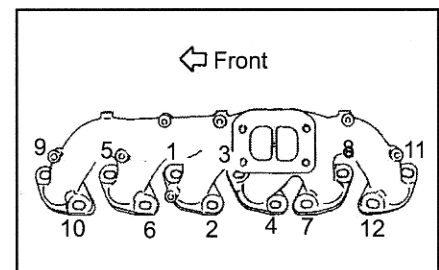

6. ROCKER COVER

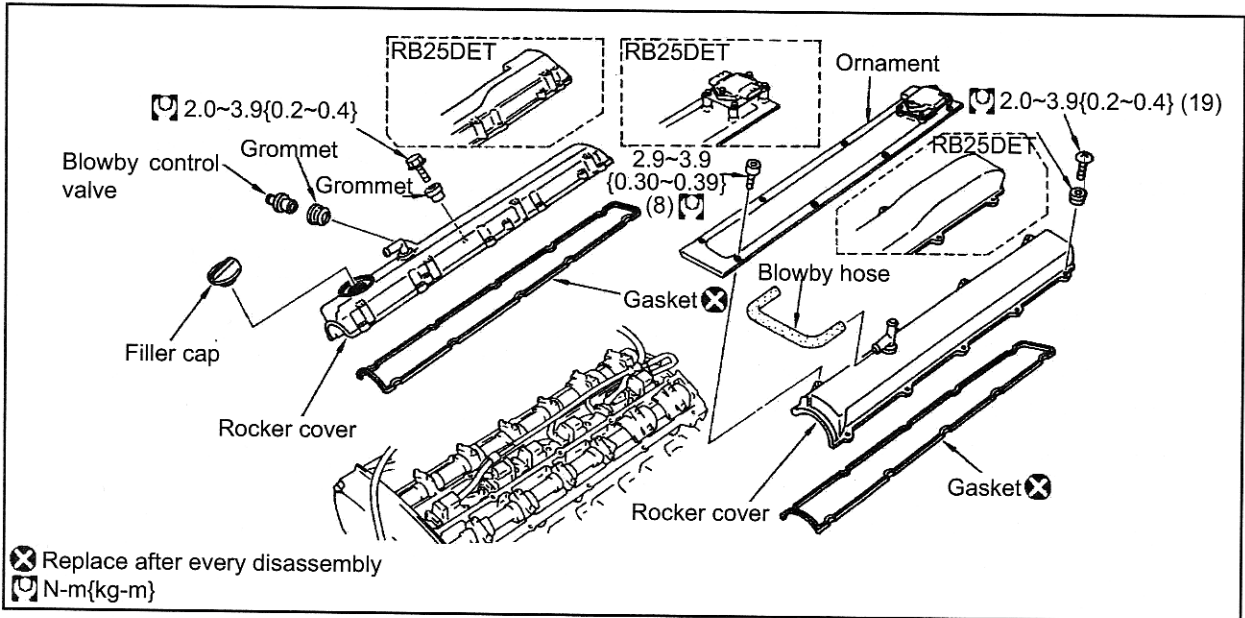

Removal

1. Remove the battery negative terminal.
 - (1) Open the boot lid.
 - (2) Remove the boot front finisher and remove the negative battery terminal.
2. Remove blowby hose.
3. Remove air duct and resonator ASSY (RB25DE).
4. Remove air inlet pipe (RB25DET).
5. Remove the canister hose (RB25DET).
6. Disconnect the power transistor unit connector.
7. Remove the ornament.
8. Disconnect ignition harness connector from the clamp.
9. Remove the rocker cover.
 - Loosen the installation screw on intake and exhaust side in order shown in the figure on right.

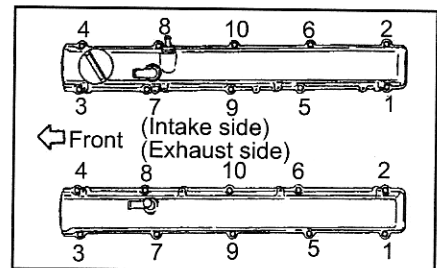

Inspection

- Check for any wear or damage on the rocker cover.
- Replace the rocker cover if any abnormality is found.
- Make sure the oil will not leak from the rocker cover and cylinder head alignment surface.

Installation

1. Install the gasket to rocker cover.
 - Replace the gasket with a new one.
2. Install the rocker cover.
 - Remove any oil and rubbish etc. from cylinder head side installation surface.
 - Intake side No.1 bolt is a hexagonal bolt.
 - Tighten the installation bolts and screws in several stages in order shown in the figure on right.
Tightening torque (N-m{kg-m}) 2.0~3.9{0.2~0.4}
3. Fix the ignition coil harness using the clamp.
4. Install the ornament.
5. Install the rest in reverse order to the removal procedure.

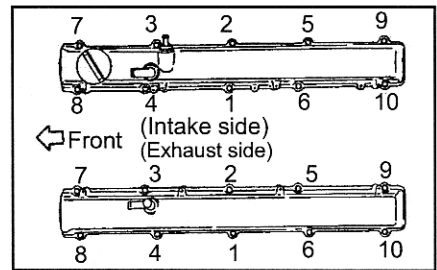

RB25DE / RB25DET ENGINE

7. OIL PAN & OIL FILTER

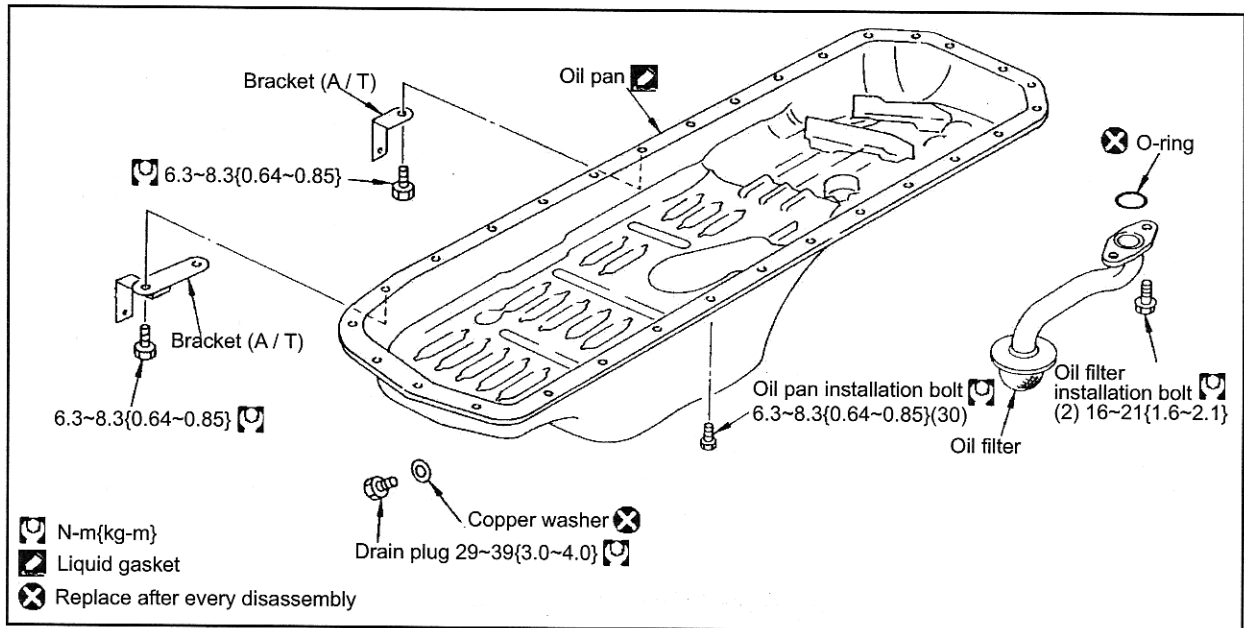

Removal

1. Remove the battery negative terminal.
 - (1) Open the boot lid.
 - (2) Remove the boot front finisher and remove the negative battery terminal.
3. Remove the under cover.
4. Drain engine oil from the oil pan drain plug.
5. Remove the stabilizer. OR remove stabilizer installation bolts and installation nuts located on the vehicle side and lower the stabilizer to below the oil pan.
6. Remove A / T oil cooler tube from the oil pan bracket.
7. Remove right and rear gasket.
8. Remove the lower rear plate (A / T vehicles).
9. Remove right and left front side engine mount installation nuts.
10. Attach the sling to engine and raise it up using the hoist.
11. Remove installation bolts in the order shown in the figure on right.

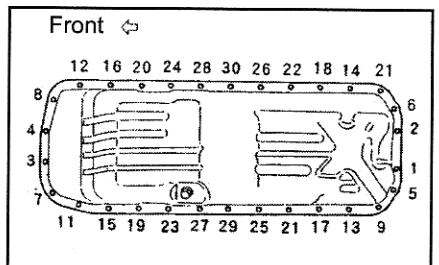
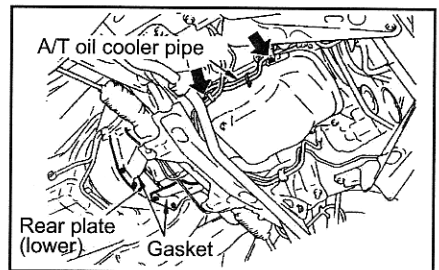
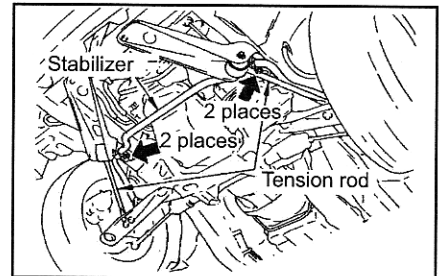

12. Remove oil pan from the cylinder block.
 - (1) Insert seal cutter between the oil pan and the cylinder block.
 - (2) Tap the seal cutter rear surface using the hammer to remove the oil pan.

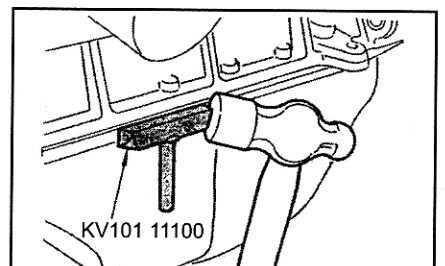

13. Remove the oil pan.

- Remove the oil pan carefully making sure it will not interfere with the oil filter net area.

14. Remove the oil filter.

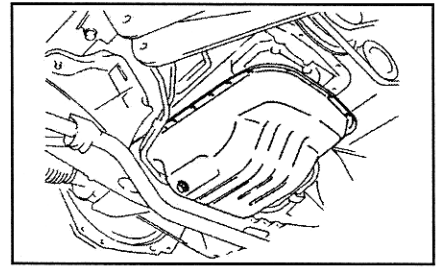
**Inspection**

Oil strainer visual inspection

- Check that there are no foreign objects on the oil filter net.
- Clean the net if there are any foreign objects.
- Replace with a new one if there is any fault.

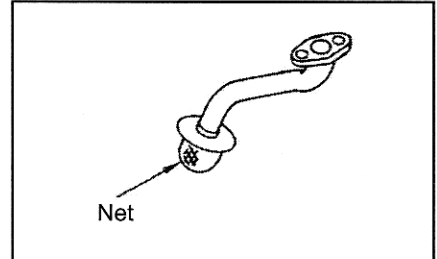
**Installation**

1. Install the oil filter.

- Replace the o-ring with a new one.

Tightening torque (N-m{kg-m}) 16~21{1.6~2.1}

2. Install the oil pan.

- Use scraper to remove any oil liquid gasket on the oil pan and cylinder block installation surface.
- Clean the installation surface using white gasoline.
- Apply bond (KP510 00150) to specified position shown in the figure on right at approx. $\Phi 3.5\sim 4.5$.

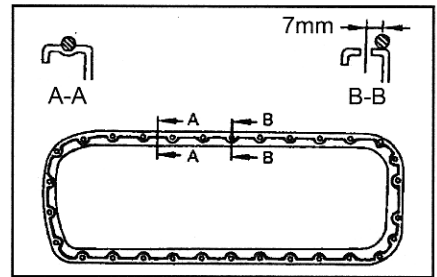

- Place the oil pan below cylinder block. Care must be taken not to allow liquid gasket to come in contact with the cylinder block and other parts.
- Place 2 bolts (M6 x 1.25) at suitable position and tighten temporarily. Install other bolts temporarily.

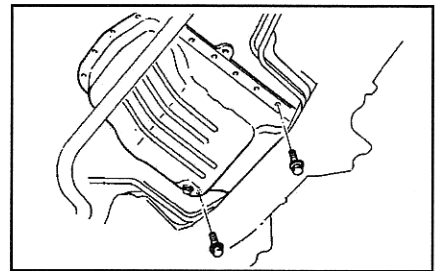

- Tighten the bolts to specified torque in order shown in the figure on right.

Tightening torque(N-m{kg-m}) 6.3~8.3{0.64~0.85}

- No. 2 and No. 20 installation bolts will also tighten A / T oil cooler pipings.

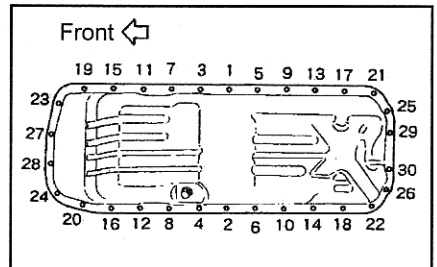
**Caution:**

Do not over tighten the installation bolts.

3. Install the oil pan drain plug.

- Replace the washer with a new one.
- Install in the direction shown.

Tightening torque (N-m{kg-m}) 29~39{3.0~4.0}

- 4. Install the rest in reverse order to the removal procedure.

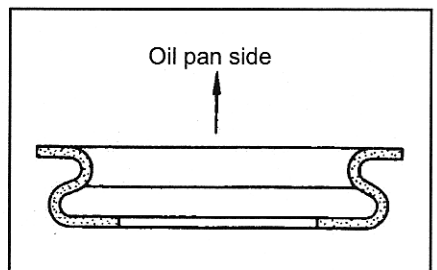
**Inspection**

- Check the level of engine oil.

RB25DE / RB25DET ENGINE

8. CAM SHAFT

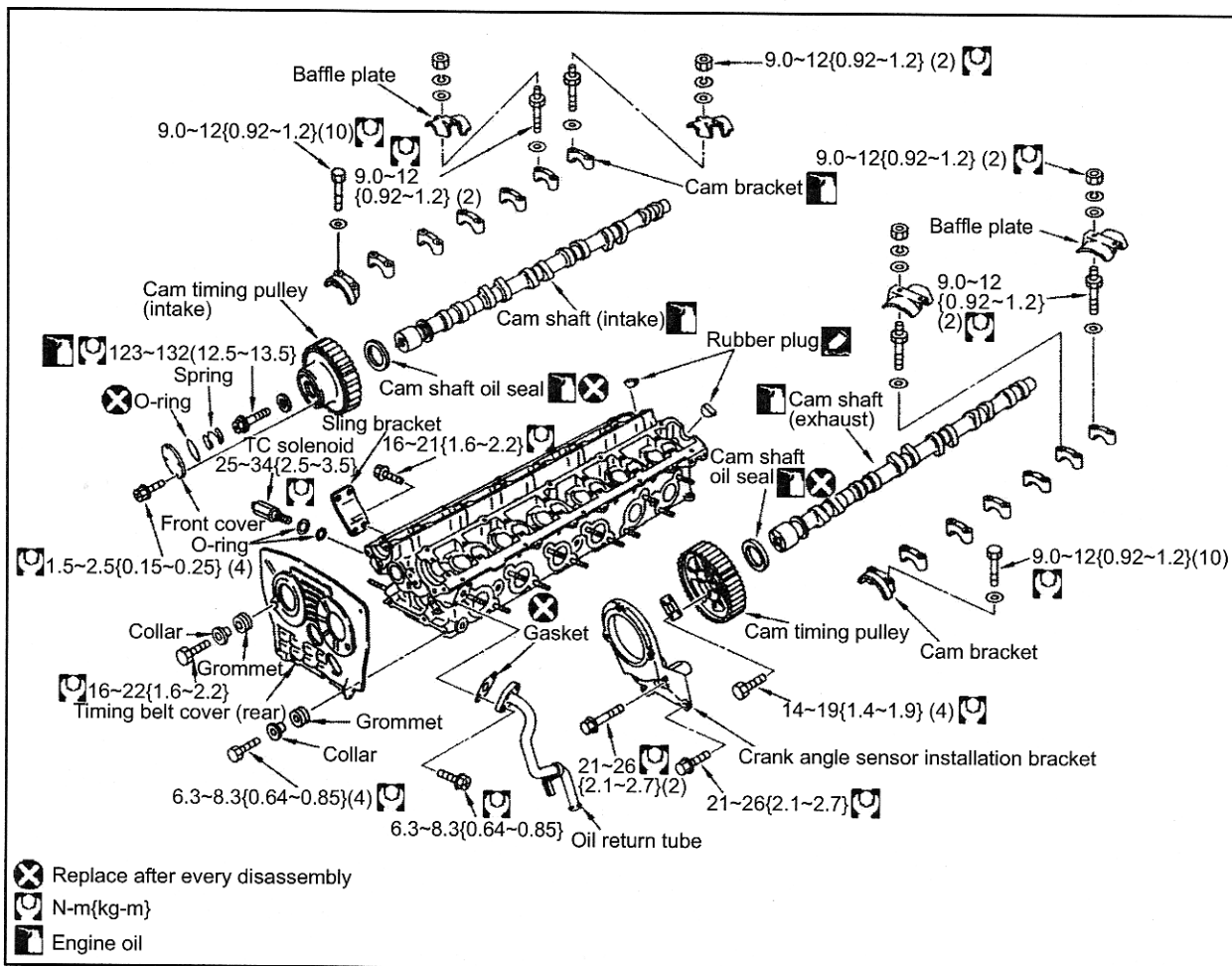

Removal

1. Remove the battery negative terminal.
 - (1) Open the boot lid.
 - (2) Remove the boot front finisher and remove the negative battery terminal.
2. Remove the under cover.
3. Remove air duct and resonator ASSY (RB25DE).
4. Remove air inlet pipe.
5. Drain coolant from the radiator drain plug.
6. Drain coolant from the cylinder block drain plug.
7. Remove cooling fan.
8. Remove the radiator.
9. Remove the auxiliary belt.
10. Remove the timing belt.
11. Remove the rocker cover.
12. Remove the cam timing pulley (intake side).
 - (1) Remove the crank angle sensor installation bracket.
 - (2) Fix cam shaft hexagonal part using the spanner to remove cam timing pulley installation bolts (4).
 - (3) Remove the cam timing pulley from the cam shaft.

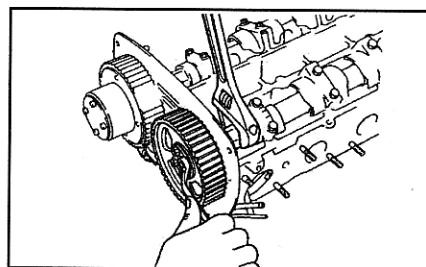

RB25DE / RB25DET ENGINE

13. Remove cam timing pulley (intake side).

(1) Remove the front cover, o-ring and the spring.

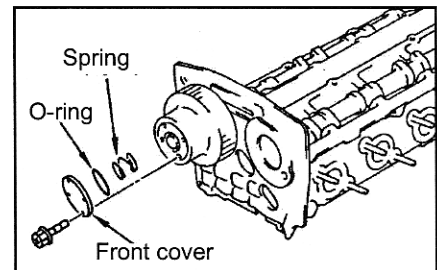

(2) Remove the cam timing pulley installation bolt by holding the cam shaft hexagonal part using the spanner.

(3) Remove cam timing pulley from the cam shaft.

Caution:

Do not use pulley holder etc. to fix when removing the intake side cam timing pulley as it could damage innards.

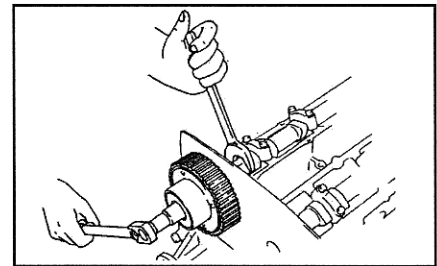

14. Remove the timing belt cover (rear).

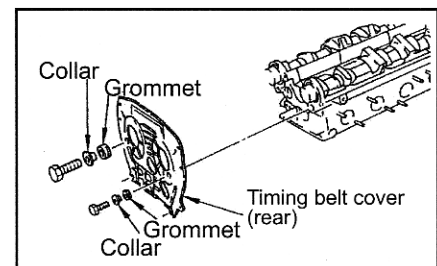

15. Remove the baffle plate from No.6 and No.7 cam shaft bracket.

16. Remove the cam bracket.

- Loosen the cam bracket installation bolts in the order shown in several stages in the figure on right.

Caution:

Before removal make sure to mark the installation position of the cam bracket.

- Inspect the cam shaft end play before loosening the cam bracket installation bolts.

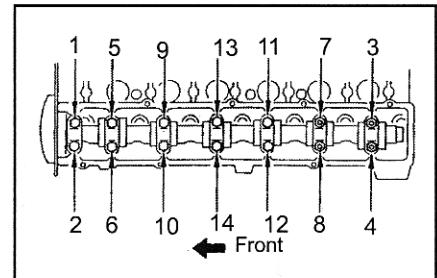

17. Remove the cam shaft.

18. Pull out the cam shaft oil seal from the cam shaft.

19. Remove the hydraulic valve lifter.

- Check the installation position and store it to avoid confusion.
- Store the hydraulic valve lifter in stand up position. If stored for a longer period of time, store it in clean engine oil.
- Do not disassemble the hydraulic valve lifter.

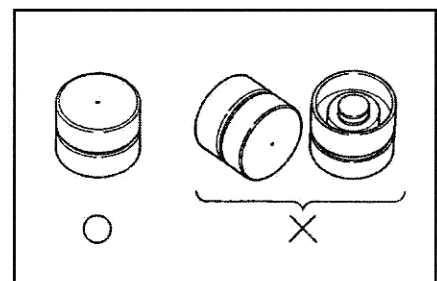

Inspection**Cam shaft visual inspection**

- Check to make sure there is no damage or wear to the cam shaft.
- Replace if any abnormalities are found.

Cam shaft run-out

- Use V-block on the fixed surface and support cam shaft No. 1 and No. 7 journal.
- Set dial gauge vertically to No. 4 journal.
- Rotate the cam shaft in one direction and read the movement width on the dial gauge.

Standard value (mm) 0.02

Limit value (mm) 0.05

- If the run-out is over the limit value replace the cam shaft.

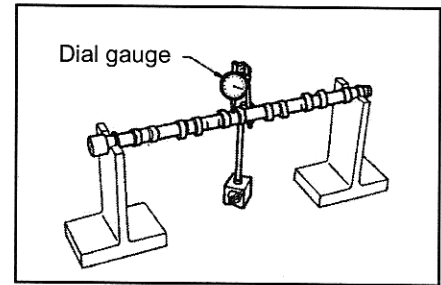
**Cam nose height**

- Use micrometer to measure cam nose height.

Standard value (mm)

Intake 39.705~39.895

Exhaust 39.705~39.895

Wear out limit value (mm)

Intake 0.05

Exhaust 0.05

- If the value is over the limit replace the cam shaft.

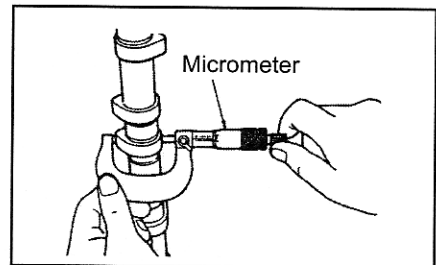
**Cam shaft oil clearance**

(Cam journal external diameter)

- Use micrometer to measure cam journal external diameter.

Standard value (mm)

No.1 ~ No.6 journal $\Phi 27.935 \sim \Phi 27.955$

No. 7 journal $\Phi 27.920 \sim \Phi 27.940$

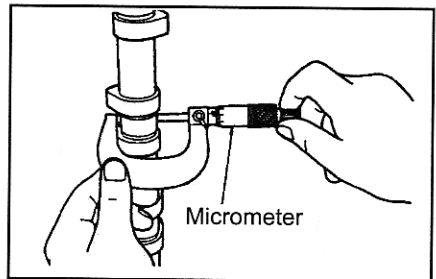

(Cam bracket internal diameter)

- Tighten cam bracket bolt to specified torque.
- Use inside micrometer to measure.

Standard value (mm) $\Phi 28.000 \sim \Phi 28.021$

(Cam shaft oil clearance) =

(Cam bracket internal diameter) -

(Cam journal external diameter)

Standard value (mm)

No.1 ~ No.6 journal $\Phi 0.045 \sim \Phi 0.086$

No.7 journal $\Phi 0.061 \sim \Phi 0.101$

- If the value is not within standard value, replace cylinder head ASSY or cam shaft.

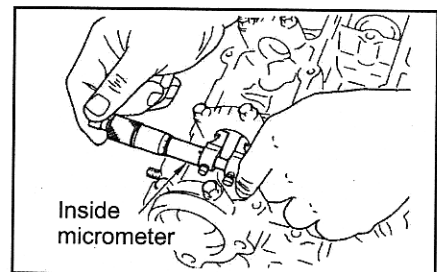

RB25DE / RB25DET ENGINE

Cam shaft end play

- Set a dial gauge at front end of the cam shaft in thrust direction. Move the cam shaft forwards and backwards and read the dial gauge run-out measurement. Standard value (mm) 0.060~0.110
- If the value is not within standard value, replace the cam shaft. Re-measure and if the value is still not at standard value, also replace the cylinder head.

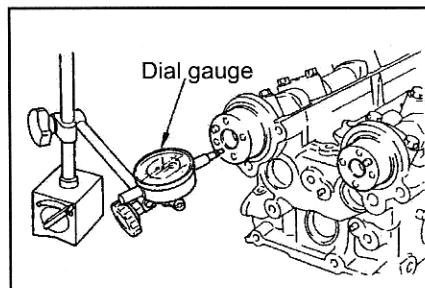

Hydraulic valve lifter visual inspection

- Look for any wear or damage on the cam shaft working face, lifter side surface and rotational parts. Replace the parts if any abnormalities are found.

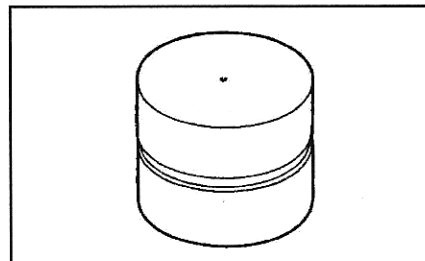

Hydraulic valve lifter clearance

(Hydraulic valve lifter external diameter)

- Use the micrometer to measure hydraulic valve lifter external diameter. Standard value (mm) $\Phi 30.955\sim 30.965$

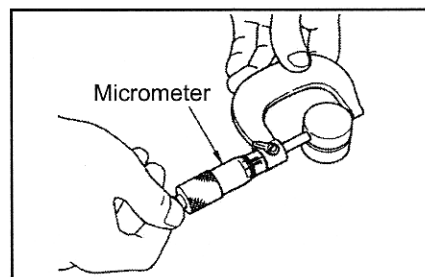

(Hydraulic valve lifter internal diameter)

- Use inside micrometer to measure hydraulic valve lifter internal diameter. Standard value (mm) $\Phi 31.000\sim 31.020$

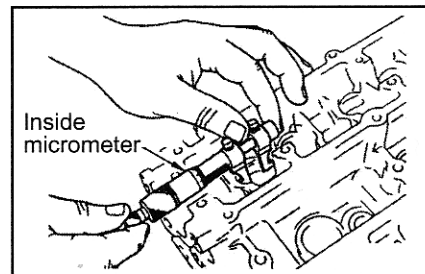

(Hydraulic valve lifter clearance) =

(Hydraulic valve lifter internal diameter) -

(Hydraulic valve lifter external diameter)

Standard value (mm) $\Phi 0.035\sim 0.065$

- If the value is not within standard value, replace hydraulic valve lifter or cylinder head.

Hydraulic valve lifter air interfusion inspection

- Apply engine oil to rotational surface and install hydraulic valve lifter to the cylinder head.
- After the installation push down on the head. If the head move more than 1 mm carry out the air release operation using the method below. (Use same method to check the valve lifter when abnormal sound is heard when the engine is started).

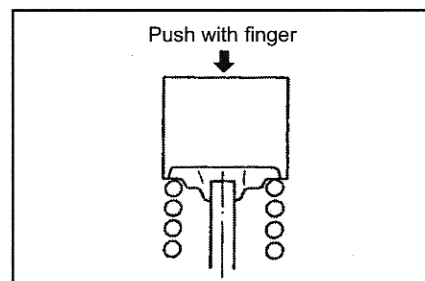

- (1) After installing the rocker cover, run the engine at approx. 1000rpm with no-load for 10 minutes. Recheck the head movement.
- (2) If the air is not released by carrying out the above method, replace the hydraulic valve lifter with a new one.

Installation

1. Install hydraulic valve lifter.
 - Apply engine oil to rotational surface.
 - Install the hydraulic valve lifter in the position before it was removed.
 - Carry out the air interfusion inspection.
2. Install cam shaft to the cylinder head.
 - Coat the cam nose, journal and thrust parts with engine oil.
 - The distinction between the intake and the exhaust side cam shaft can be determined by the crank angle sensor drive spline gear.
3. Install the cam shaft to the cylinder head so the knock pin is as shown in the figure.

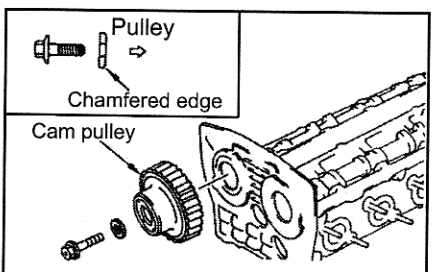
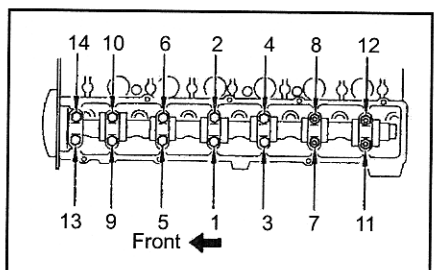
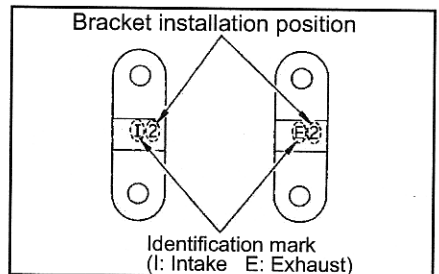
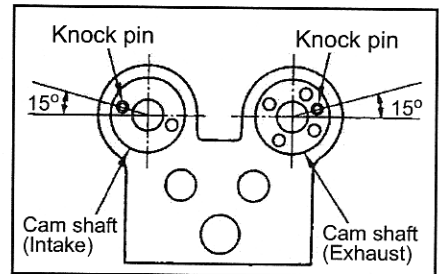
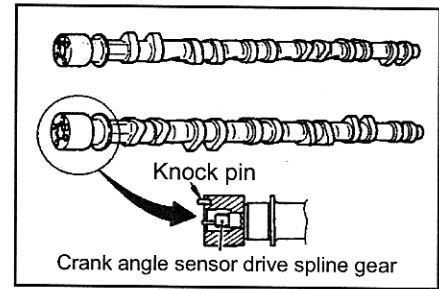

4. Install the cam bracket.
 - (1) Check the engraved mark on the cam bracket surface and the markings you have made at the removal to install the cam bracket in correct position.
 - (2) Tighten the cam bracket installation bolts in the order shown in several stages.

Tightening torque (N-m{kg-m})	9.0~12{0.92~1.2}
-------------------------------	------------------
5. Install the baffle plate to No. 6 and No. 7 cam shaft bracket.

Tightening torque(N-m{kg-m})	9.0~12{0.92~1.2}
------------------------------	------------------

6. Install the timing belt cover (rear).

Tightening torque (N-m{kg-m})	
M6 bolt	6.3~8.3{0.64~0.85}
M8 bolt	16~22{1.6~2.2}

7. Install the cam shaft front oil seal.
8. Install the cam timing pulley (intake side).
 - (1) Install the cam timing pulley to the cam shaft.
 - Face the washer with chamfered side towards the pulley.
 - (2) Apply engine oil to thread parts and the bearing surface of the installation bolts.

RB25DE / RB25DET ENGINE

- (3) Use the spanner to fix cam shaft hexagonal part to tighten installation bolt.

Caution:

Do not use tools such as pulley holder to fix intake side cam timing pulley as it will damage inner parts.

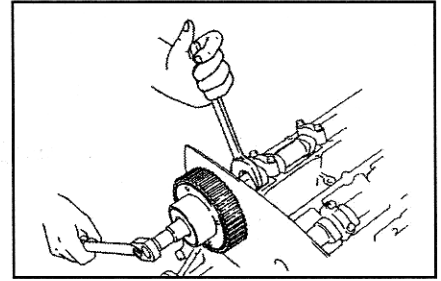

- (4) Insert a spring into pulley and fit the front cover.
- Replace the o-ring with a new one.
 - Care must be taken not to drop the o-ring.
- (5) Tighten installation bolts in opposite angles.
Tightening torque (N-m{kg-m}) 1.5~2.5{0.15~0.25}

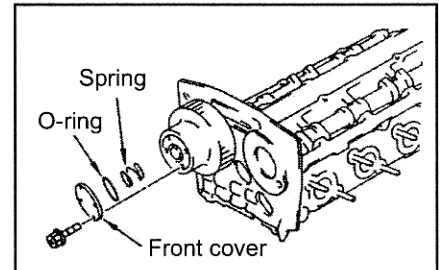

9. Install the cam timing pulley (exhaust side).
- (1) Install the cam timing pulley to the cam shaft.
- Fix the cam shaft hexagonal part using a spanner or use pulley holder to fix the timing pulley to tighten 4 installation bolts in opposite angle.
Tightening torque (N-m{kg-m}) 14~19{1.4~1.9}
- (2) Install the crank angle sensor installation bracket.
Tightening torque (N-m{kg-m}) 21~26{2.1~2.6}

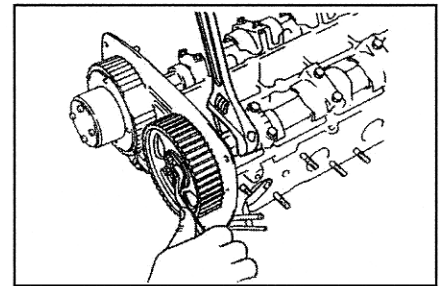

10. Install the rest in reverse order to the removal procedure.

9. CYLINDER HEAD GASKET

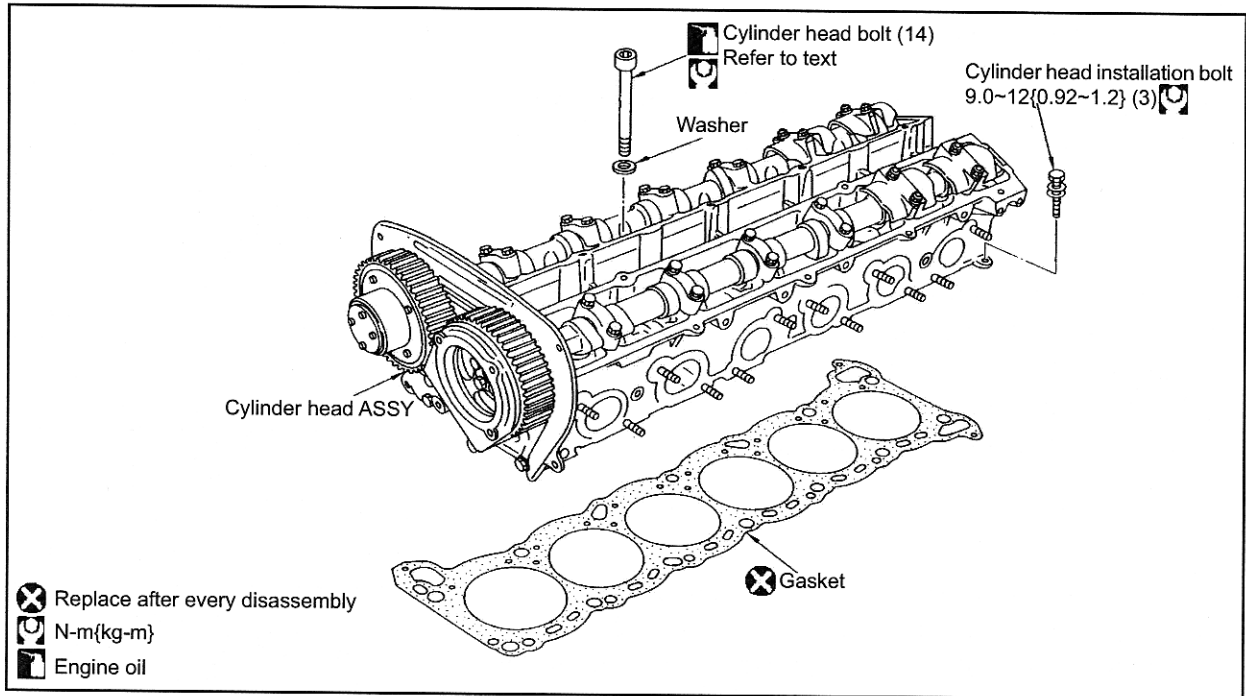

Removal

1. Release the fuel pressure.
2. Remove the battery negative terminal.
 - (1) Open the boot lid.
 - (2) Remove the boot front finisher and remove the negative battery terminal.
3. Remove the air duct and the resonator ASSY.
4. Remove the air inlet pipe.
5. Remove the under cover.
6. Drain coolant from the radiator drain plug.
7. Drain coolant from the cylinder block drain plug.
8. Remove the cooling fan.
9. Remove the radiator.
10. Remove the auxiliary belt.
11. Remove exhaust front tube.
12. Remove the turbo charger ASSY.
13. Remove exhaust manifold.
14. Remove intake manifold collector.
15. Remove the fuel injector.
16. Remove the intake manifold.
17. Remove the rocker cover.
18. Remove the timing belt, cam timing pulley, timing belt cover (rear).
19. Remove oil return tube and the top installation bolt on the power steering pump bracket.

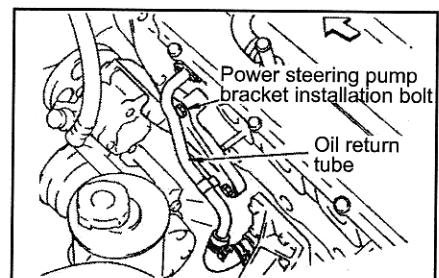

RB25DE / RB25DET ENGINE

20. Remove the cylinder head ASSY.

(1) Remove the cylinder head auxiliary bolts (1~3).

(2) Remove the cylinder head bolts (4~17).

- Loosen the cylinder head bolts in the order shown in the figure on right to remove the cylinder head ASSY.

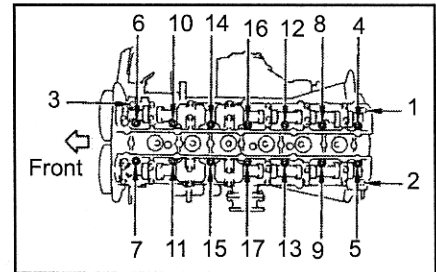

1~3: M6 x 1.0 4~7: M12 x 1.5

21. Remove the cylinder head gasket.

Inspection

Cylinder head distortion

- (1) Use a scraper to remove grease, water stain, carbon and gasket etc.

Caution:

Care must be taken not to allow removed gasket to enter oil and coolant passage.

- (2) Measure cylinder head under surface for distortion in six direction.

Limit value (mm) 0.2

- If the value exceeds the limit apply compound to press platen and readjust the surface. If the value exceeds the limit greatly, replace the cylinder head with a new one.

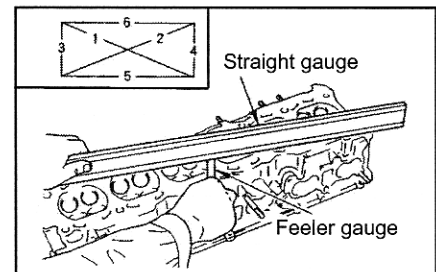

Cylinder block top surface distortion

- Use a scraper to completely remove gasket, oil, water stain and carbon etc. on cylinder block front surface.

Caution:

Care must be taken not to allow removed gasket to enter oil and coolant passage.

- Measure distortion of the block top surface in six directions using a straight gauge.

Limit value (mm) 0.1

- If the value is over the limit use surface grinder to correct the distortion.
- Replace the cylinder block if the distortion value is too great.

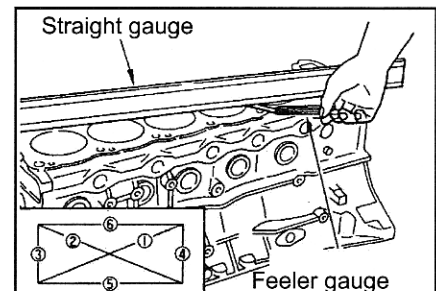

Installation

1. Install the cylinder head gasket.

- Use scraper to remove gasket on the installation surface.
- Replace the gasket with a new one.
- Align the cylinder head gasket to dowel pin to install.

RB25DE / RB25DET ENGINE

2. Install the cylinder head ASSY.
 - Check that No. 1 cylinder is at T. D. C (top dead centre)
 - Make sure each No. 1 cylinder intake and exhaust valve is not lifted.
 - Care must be taken not to damage the cylinder head gasket when installing the cylinder head.
3. Tighten the cylinder head bolts.
 - Apply engine oil to thread part of the screw.
 - Install the washer non-chamfered side facing the cylinder head.

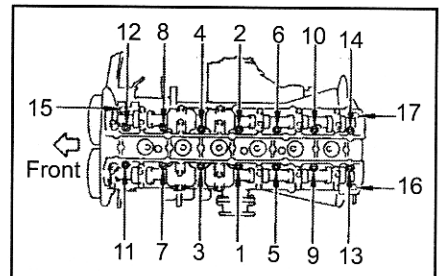
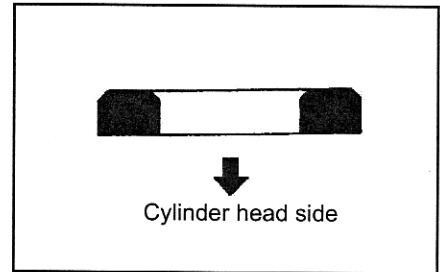

1 ~ 4: M12 x 1.5 15 ~ 17: M6 x 1.0

4. Tighten the installation bolts in the order shown (1 ~ 14).

- (1) Tighten to 29N-m {3kg-m}
- (2) Tighten to 98N-m {10kg-m}
- (3) Loosen to 0N-m {0kg-m}
- (4) Tighten to 25~34N-m {2.5~3.5kg-m}
- (5) Tighten to 95° ~ 100°
(OR 93~103N-m{9.5~10.5kg-m})
- Install the cylinder head auxiliary bolts.

Caution:

Tightening angle should be checked using the angle wrench or protractor. Never estimate visually.

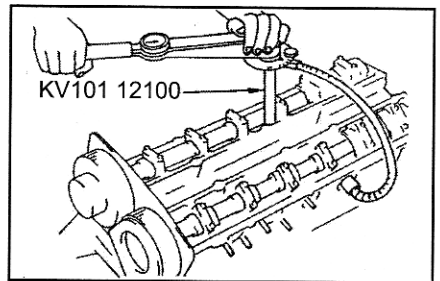

5. Install the oil return tube.
 - Replace the gasket with a new one.
Tightening torque (N-m{kg-m}) 6.3~8.3{0.64~0.85}
6. Install the top installation bolts for the power steering pump bracket.
 - Tightening torque (N-m{kg-m}) 37~50{3.8~5.1}

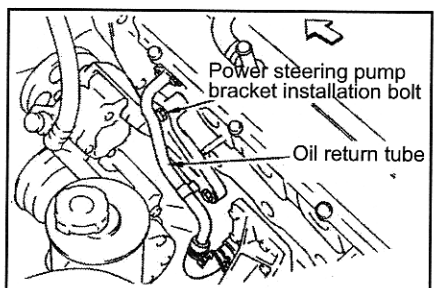

7. Install the rest in reverse order to the removal procedure.

10. OIL PUMP

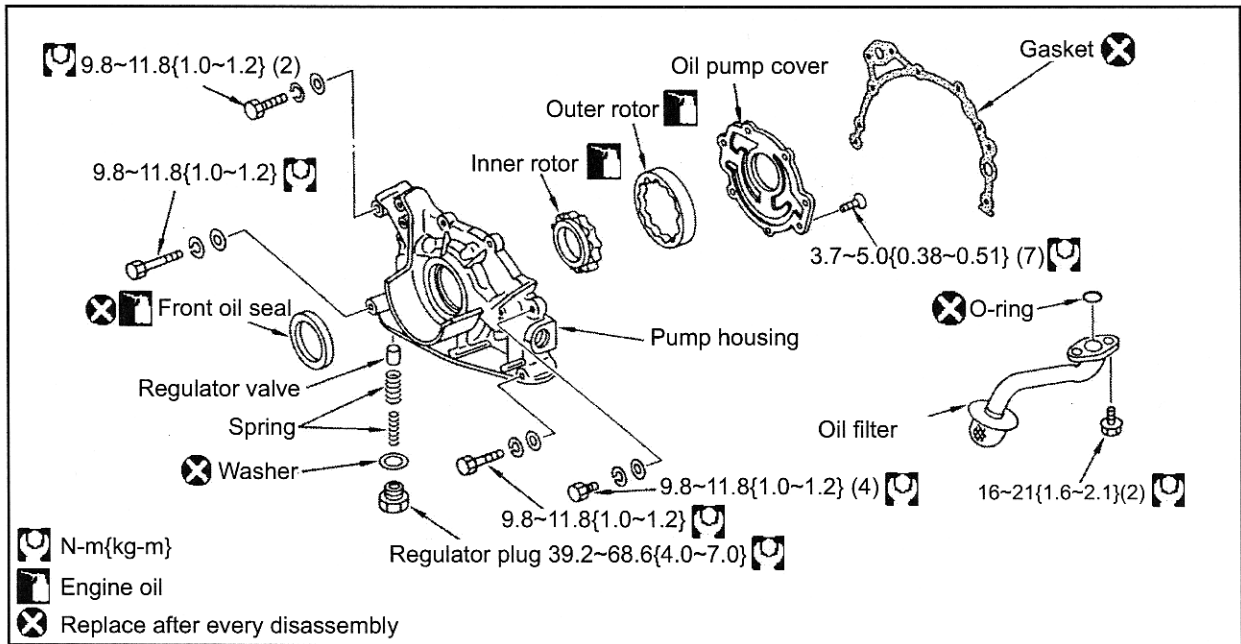

Removal

1. Remove the battery negative terminal.
 - (1) Open the boot lid.
 - (2) Remove the boot front finisher and remove the negative battery terminal.
2. Remove the under cover.
3. Drain coolant from the radiator drain plug.
4. Drain the engine oil from the oil pan.
5. Remove the air duct (external air introduction side).
6. Remove the cooling fan.
7. Remove the radiator.
8. Remove auxiliary belt.
9. Remove the timing belt.
10. Remove the crank timing pulley.
11. Remove the timing belt rear cover.
12. Remove the oil pan.
13. Remove the oil pump.

Installation

1. Install the oil pump.
 - Use a scraper to remove old gasket from the oil pump and the cylinder block.
 - Use white gasoline to remove grease, water and rubbish from the installation surface.
 - Replace the gasket with a new one.
 - Align to the knock pin on the cylinder block side to install.
 - There are four types of oil pump installation bolts. Make sure to use the correct bolts.

RB25DE / RB25DET ENGINE

Installation position	Number	Installation bolt length below head (mm)
1	4	20
2	2	35
3	1	45
4	1	55

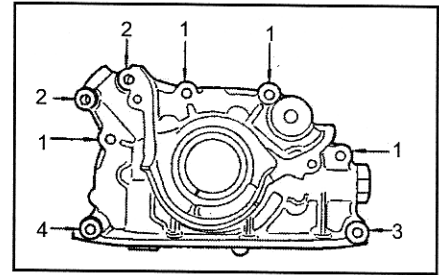

Tightening torque (N-m{kg-m}) 9.8~11.8{1.0~1.2}

2. Install the rest in reverse order to the removal procedure.

Disassembly

1. Remove the front oil seal.
 - Use a tool such as a screwdriver to remove.

Caution:

Care must be taken not to damage the oil pump housing.

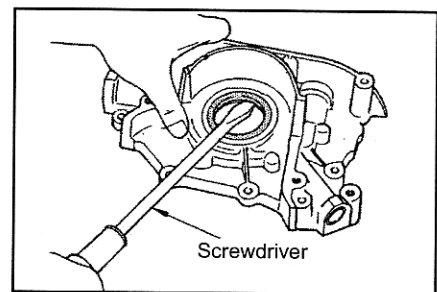

2. Remove the oil pump cover.
3. Remove the inner and outer rotor.
4. Disconnect the regulator plug and remove the spring and the regulator valve.

Inspection

Oil pump visual inspection

- Check for any wear or damage on the inner and outer rotor and the oil pump housing.
- Replace the oil pump ASSY if there is any abnormality.

Oil pump parts clearance inspection

- Use the feeler gauge to check the following clearance.

- (1) Outer rotor to oil pump housing clearance
Standard value (mm) 0.11~0.2
- (2) Outer rotor and inner rotor chip clearance.
Standard value (mm) Below 0.180
- (3) Inner rotor to oil pump housing side clearance
Standard value (mm) 0.05~0.09
- (4) Outer rotor to oil pump housing side clearance
Standard value (mm) 0.05~0.11

- Replace the oil pump ASSY if any of the measurements are out of standard value.

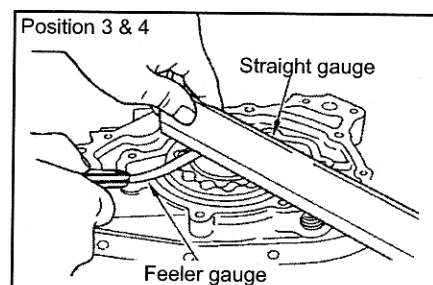
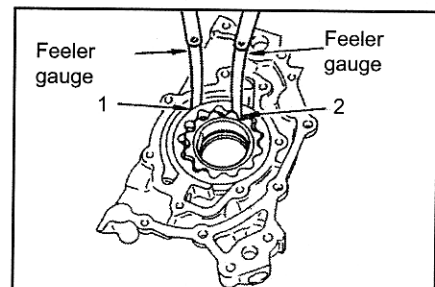

RB25DE / RB25DET ENGINE

(5) Inner rotor to oil pump housing inlow area clearance.

- Use method below to measure the clearance between the inner rotor and oil pump housing inlow area.
- Use a micrometer to measure the oil pump housing inlow inner diameter.

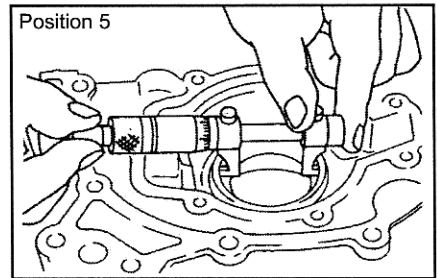

(6) Use a micrometer to measure the inner rotor inlow outer diameter.

(Inner rotor to oil pump housing inlow area clearance) =
 (Oil pump housing inlow inner diameter) -
 (Oil pump housing inlow outer diameter)
 Standard value (mm) 0.045~0.091

- Replace the oil pump ASSY if the measurements are out of standard value.

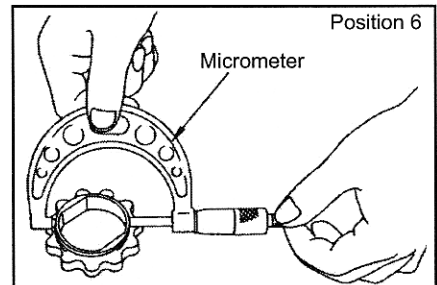

Regulator valve visual inspection

- Check for any wear or damage on the regulator valve rotational parts.
- Check the regulator spring for any abnormality.
- Replace the regulator valve or the oil pump ASSY if there is any fault.

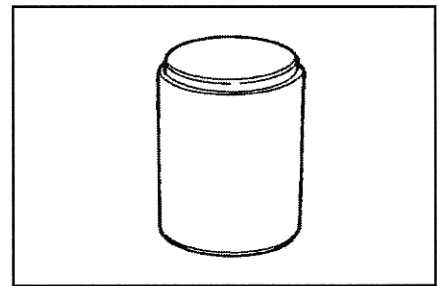
**Assembly**

1. Install the inner and the outer rotor.
 - Apply engine oil to each rotational and moving parts.
 - Position the inner rotor groove to cover side.

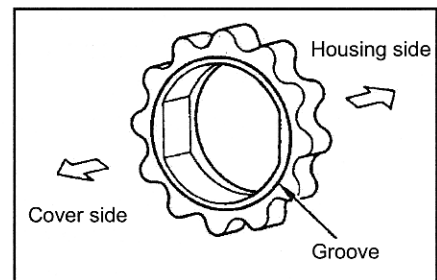

2. Tighten the oil pump cover installation screws equally.

Tightening torque (N-m{kg-m}) 3.7~5.0{0.38~0.51}

3. Install the regulator valve.

- Apply engine oil to rotational parts.
- Replace the regulator washer with a new one.
- Tighten the regulator plug.

Tightening torque (N-m{kg-m}) 39~69{4.0~7.0}

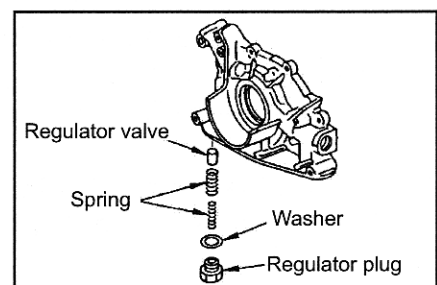

4. Install the front oil seal.

- Replace the oil seal with a new one.
- Check if there is any damage or deformation on oil seal periphery.
- Position the oil seal side with writing towards front.
- Use the oil seal drift to insert the oil seal in until level with installation surface.
- Apply engine oil or chassis grease to oil seal lip surface.

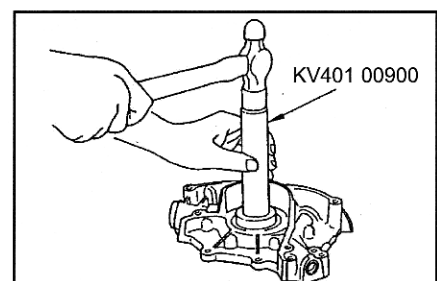

RB25DE / RB25DET ENGINE

11. RADIATOR

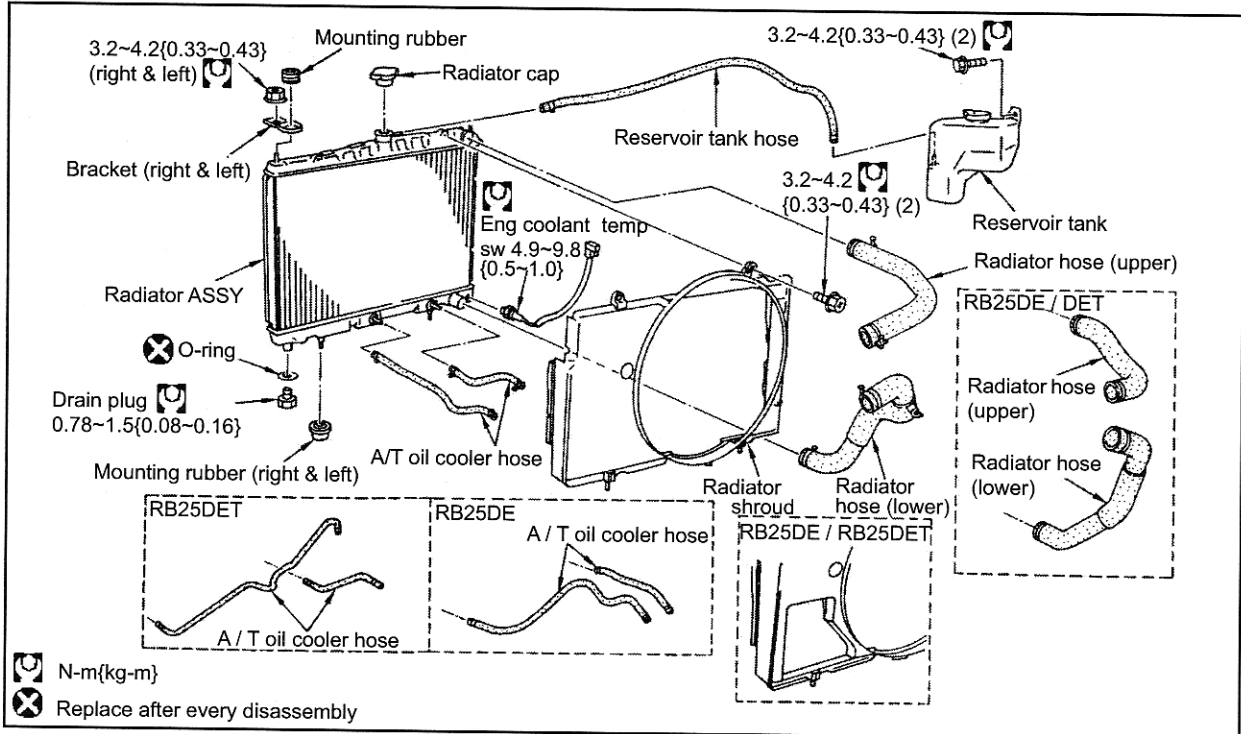
**Removal**

1. Remove the battery negative terminal.
 - (1) Open the boot lid.
 - (2) Remove the boot front finisher and remove the negative battery terminal.
2. Remove the under cover.
3. Drain coolant from the radiator drain plug.
4. Remove the air duct.
5. Remove the reservoir tank hose on the radiator side.
6. Remove the radiator upper hose.
7. Remove the radiator lower hose.
8. Remove the A/T oil cooler hose (A/T vehicle).
 - Place a hole cap on the A/T oil cooler pipe.
9. Disconnect the engine coolant temperature switch harness connector.
10. Remove the radiator upper mount bracket (right & left).
11. Remove the radiator ASSY.
 - Care must be taken not do damage the radiator core.
12. Remove the radiator shroud from the radiator.
13. Remove the engine coolant temperature switch from the radiator.

Installation

1. Install the engine coolant temperature switch to the radiator.
Tightening torque (N-m{kg-m}) 4.9~9.8{0.5~1.0}
2. Install the radiator shroud to the radiator.
Tightening torque (N-m{kg-m}) 3.2~4.2{0.33~0.43}
- Care must be taken not to damage the radiator core.
- Only use genuine shroud installation bolts.
3. Install the radiator ASSY.
- Care must be taken not to damage the radiator core.
4. Install right and left radiator upper mount bracket.
Tightening torque (N-m{kg-m}) 3.2~4.2{0.33~0.43}
5. Install the engine coolant temperature switch harness.
6. Install A/T oil cooler hose (A/T vehicle).
7. Install the rest in reverse order to the removal procedure.

Inspection

- Check the level of coolant and A/T fluid. Top up if necessary.
- Start the engine and look for any coolant or A/T fluid leakage.

12. COOLING FAN

Removal

1. Remove the battery negative terminal inside the boot.
2. Remove the air duct.
3. Loosen the cooling fan installation nuts.
4. Loosen the fan belt.
5. Remove the installation nuts to remove the cooling fan.
6. Remove the installation bolts to remove the fan from the cup ring.

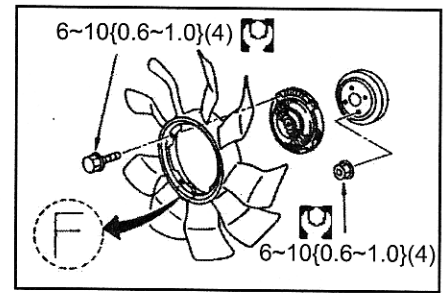

Inspection

Cup ring inspection

- Check for any silicon oil leak and bimetal bent.

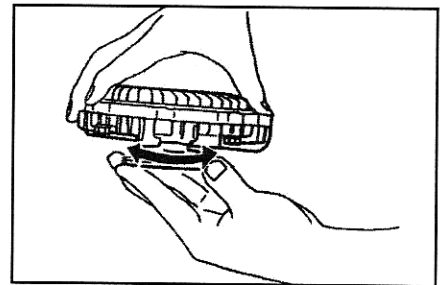

Cooling fan inspection

- Check for any damage or cut.

Installation

Install the parts in reverse order to the removal procedure.

- Install the fan to the cup ring making sure the front mark is facing front.
Tightening torque (N-m{kg-m}) 6~10{0.6~1.0}
- Adjust the fan belt tension.

13. AUXILIARY MOTOR FAN

Removal

1. Remove the battery negative terminal inside the boot.
 - (1) Open the boot lid.
 - (2) Remove the boot front finisher and remove the negative battery terminal.

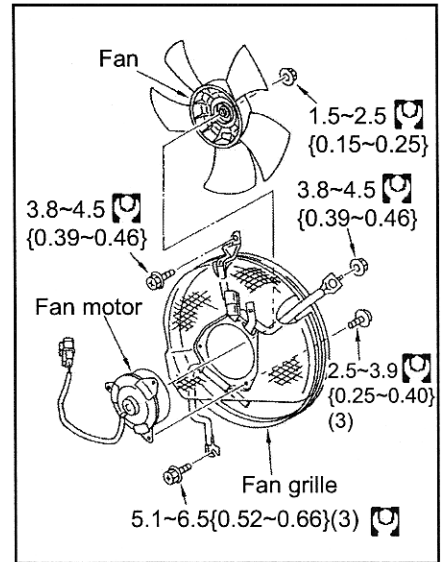

2. Remove the auxiliary fan harness connector.
3. Remove three installation bolts to remove the radiator fan from below.

Caution:

Care must be taken not to damage the air conditioner condenser.

4. Remove the fan from the fan motor.
5. Remove the fan motor from the fan grille.

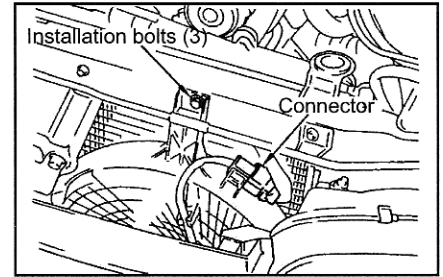

Installation

1. Install the fan motor to the fan grille.

Tightening torque (N·m{kg-m}) 2.5~3.9{0.25~0.40}
2. Install the fan to the fan motor.

Tightening torque (N·m{kg-m}) 1.5~2.5{0.15~0.25}
3. Install the auxiliary motor fan.

Caution:

Care must be taken not to damage the air conditioner condenser.

Tightening torque (N·m{kg-m}) 5.1~6.5{0.52~0.66}

4. Install the auxiliary motor fan harness connector.
5. Install the rest in reverse order to the removal procedure.

RB25DE / RB25DET ENGINE

14. WATER PUMP

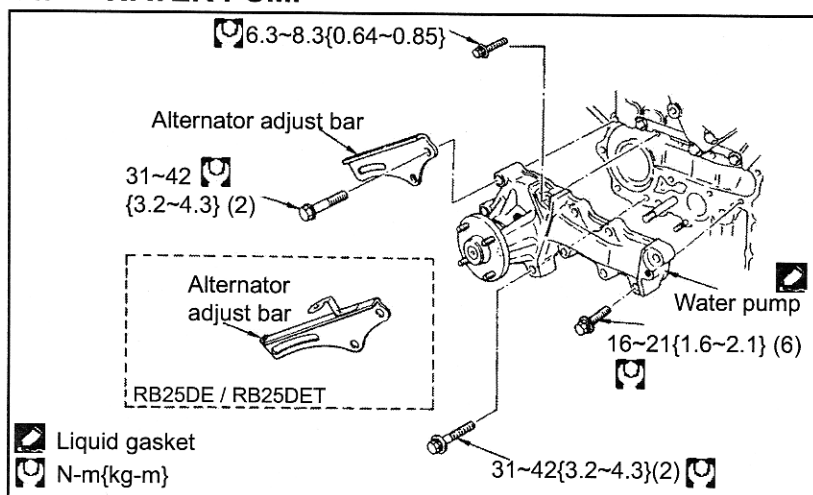
**Removal**

1. Remove the battery negative terminal inside the boot.
2. Remove the air duct.
3. Remove the under cover.
4. Drain coolant from the radiator drain plug.
5. Drain coolant from the cylinder block drain plug.
6. Remove the cooling fan.
7. Remove the radiator.
8. Remove the auxiliary belt.
9. Remove the water pump pulley.
10. Remove the timing belt.
11. Remove the tensioner pulley.
12. Remove the tensioner pulley and the idler pulley.
13. Remove the alternator adjust bar.
14. Remove the installation bolts in the order shown.
15. Remove the water pump.

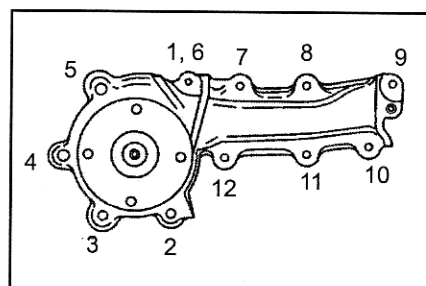

- Insert the stubby driver into the installation bolt hole and move it up and down to remove.

Caution:

Care must be taken not to damage the cylinder block side screws.

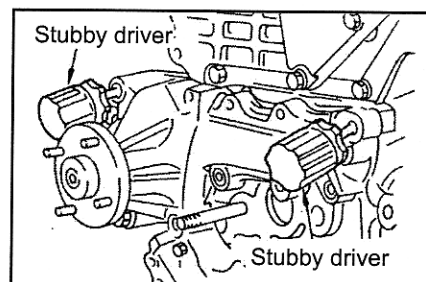

Inspection

- Check the water pump main body and the vane for rust or foreign objects.
- Make sure the water pump is not warpy.
- Replace the water pump if there are any abnormalities.

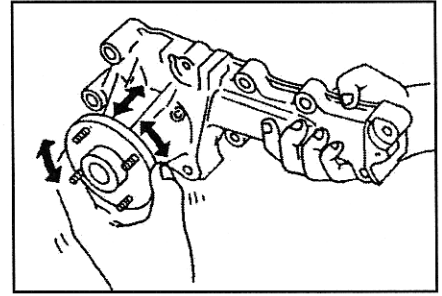

Installation

1. Install the water pump.
 - Use a scraper to remove old gasket from the water pump and the cylinder block installation surface.
 - Clean the installation surface with white gasoline.
 - Apply sealing agent (KP710 00150) to the position shown in approx. $\Phi 2.0\sim 3.0\text{mm}$.

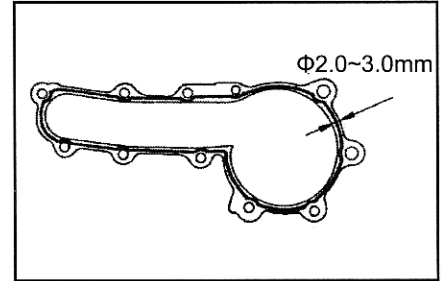

- Tighten the installation bolts in the order shown.
- Tighten the installation bolts 8 and 9 together with the alternator adjust bar.

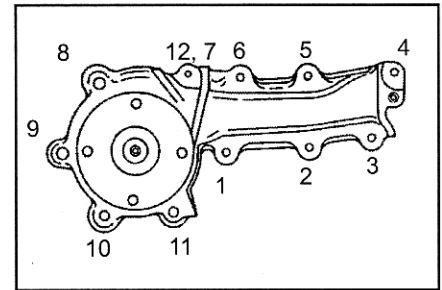

- There are four types of installation bolts.

Tightening torque (N-m{kg-m})

M6	6.3~8.3{0.64~0.85}
M8	16~21{1.6~2.1}
M10	31.4~42.1{3.2~4.3}

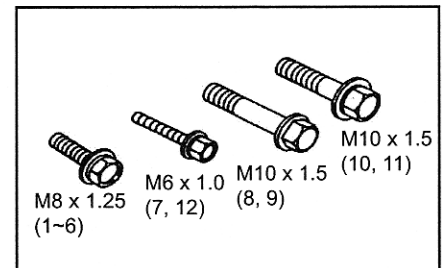

2. Install the rest in reverse order to the removal procedure.

15. THERMOSTAT & WATER INLET**Removal**

1. Remove the battery negative terminal inside the boot.
 - (1) Open the boot lid.
 - (2) Remove the boot front finisher and remove the negative battery terminal.
2. Drain coolant from the radiator drain plug.
3. Drain coolant from the cylinder block drain plug.
4. Remove the alternator belt to shift the alternator down.
5. Remove the alternator adjust bracket.
6. Remove the radiator lower hose at the thermostat housing side.
7. Remove the water inlet.
 - Insert end of a tool such as a screwdriver into the thermostat housing and move it up and down to remove.
8. Remove the thermostat.

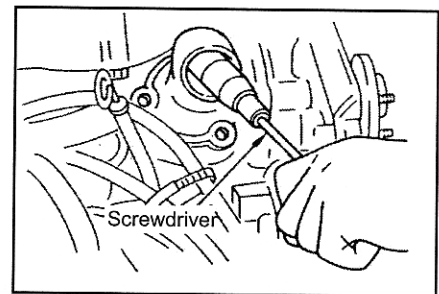
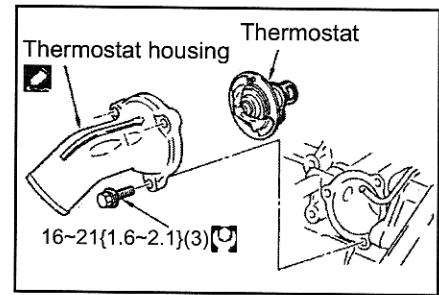
**Inspection****Thermostat inspection**

Check the valve opening temperature and maximum valve lift.

- Hang the thermostat by string on the valve and submerge in heated water in double walled container and stir water while heating it up.
- The opening temperature is the temperature when the valve opens and thermostat falls from the string.

Valve opening temperature (°C)	76.5
Max. valve lift (mm/°C)	Over 10 / 90
- Replace the thermostat if the value is not at standard value.

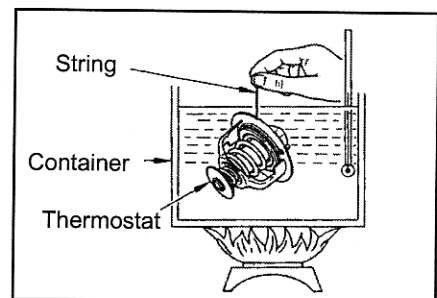
**Installation**

1. Use a scraper to remove old liquid gasket from the water inlet and the cylinder block installation surface.
 - Use white gasoline to clean the surface.
2. Install the thermostat.
 - Position the thermostat so the jiggle valve (TOP mark) is on the top.

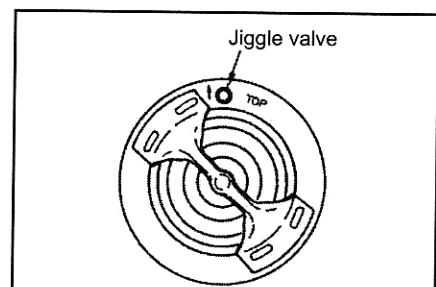

RB25DE / RB25DET ENGINE

3. Install the water inlet.

- Apply sealing agent (KP510 00150) at approx. $\Phi 2.0\sim 3.0\text{mm}$ as shown in the figure.

- Tighten the installation bolts.

Tightening torque (N-m{kg-m}) 16~21{1.6~2.1}

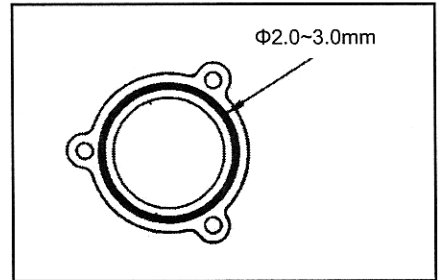

- 4. Install the rest in reverse order to the removal procedure.

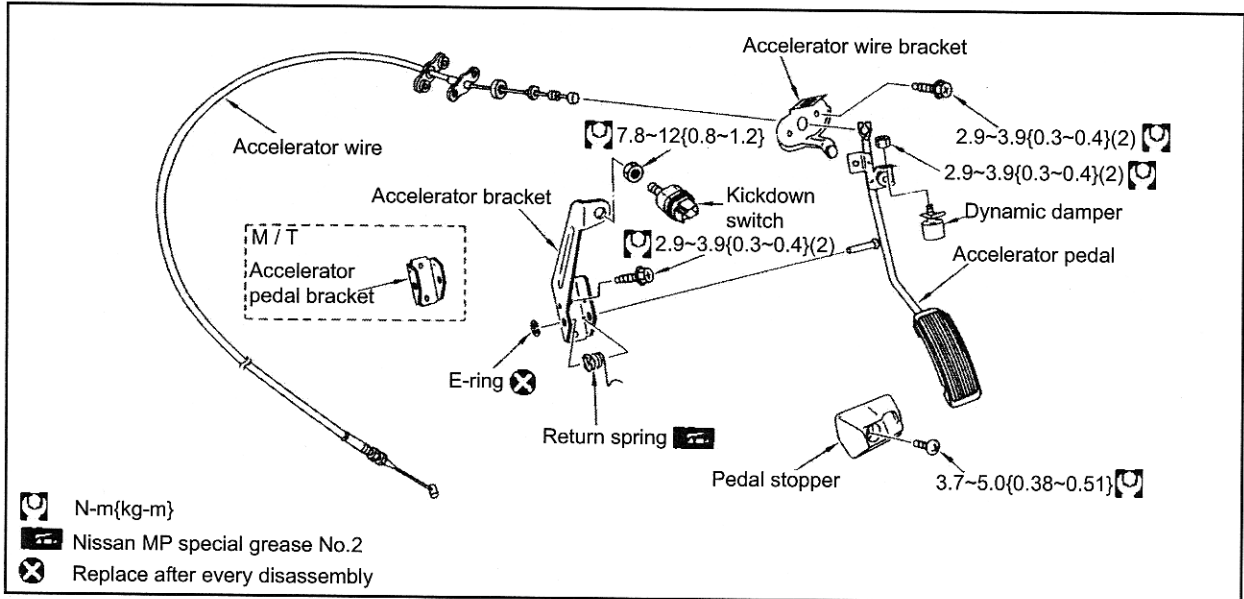
16. ACCELERATOR CONTROL SYSTEM**Removal**

1. Disconnect the accelerator wire at throttle drum side.
2. Disconnect the accelerator wire at accelerator pedal side.
3. Remove the accelerator pedal bracket installation bolt to remove the accelerator pedal / bracket ASSY.

Installation

Installation is the reverse order of the removal procedure.

- Apply Nissan MP special grease No. 2 to the return spring.
- Replace E-ring with a new one.
- Adjust the installation position when the kickdown switch is removed (A/T).
- Depress the accelerator pedal so the throttle drum is in full open position. In this position adjust the opening to approx. 0.3~1.0mm, then tighten the lock nut. Kickdown switch lock nut installation torque (N-m{kg-m}) 7.8~12{0.8~1.2}

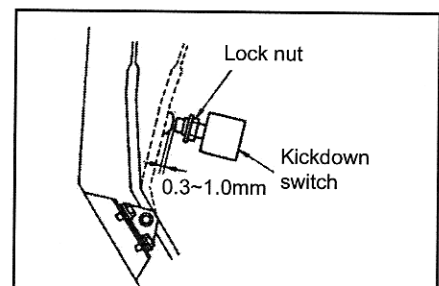
**Caution:**

- Do not position the switch to fully open stopper.
- Do not damage or bend the wire.
- Make sure to apply grease to each parts except for the inner wire at installation.

Inspection

- Make sure the throttle drum side is fully open when the accelerator pedal is depressed fully.
- Make sure the parts will move smoothly.

Adjustment

- Loosen the wire and adjust the adjust nut to pull the outer case towards the accelerator pedal until the throttle drum starts to move.
From this position turn back the adjust nut 1.5 ~ 2.0 turns, and secure the lock nut.

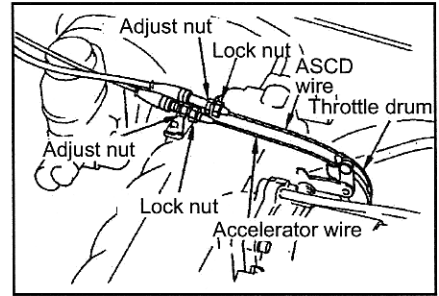

RB25DE / RB25DET ENGINE

17. EXHAUST SYSTEM

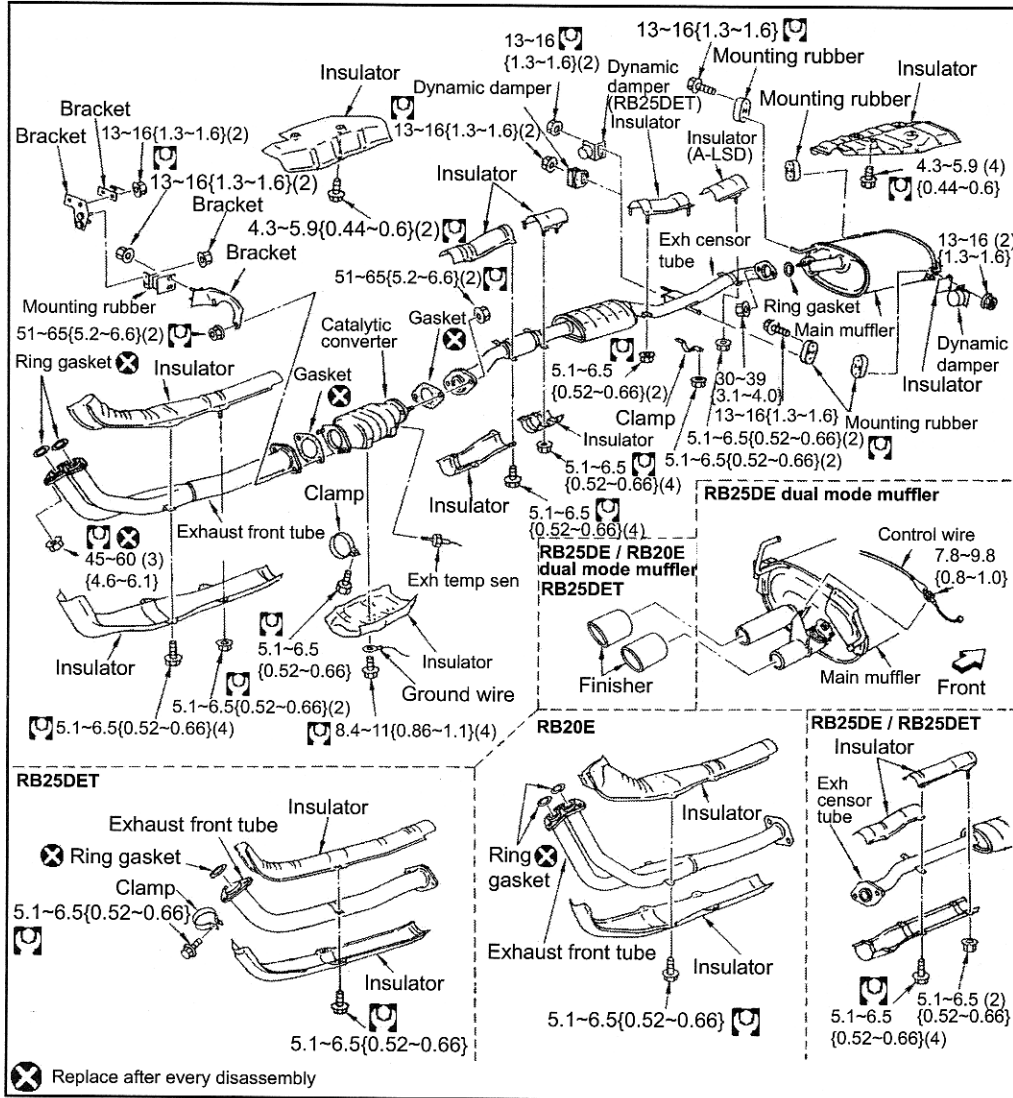

Removal

- Disconnect each part at connection and remove.
- Remove the muffler in the following way for the vehicle with dual mode muffler:
 - (1) First remove the main muffler rear mounting rubber and lower the rear end before separating with the rear tube.
 - (2) Disconnect dual mode muffler control wire from the main muffler.
 - (3) Remove the main muffler.

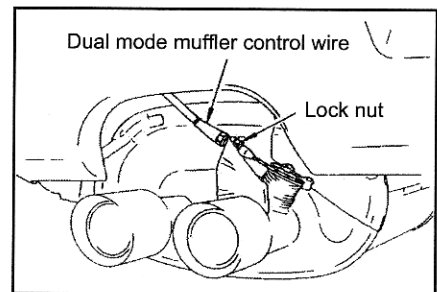

Installation

- Replace or repair the heat shield plate with deformation. Clean and remove foreign objects.
- Make sure there is no excessive gap between exhaust pipe and the heat shield plate when installed.

RB25DE / RB25DET ENGINE

- Remove old gasket etc. from each sealing surface at the connection. Connect securely to avoid any gas leaks.
- Replace each gasket with a new one.
- Replace the front tube installation nut with a new one.
- Install each clamp by aligning the insulator projection and the clamp hole.
- Install the dual mode muffler control wire. Lock nut tightening torque (N-m{kg-m})
7.8~9.8{0.8~1.0}
- Adjust the dual mode muffler control wire on the actuator side.
- Do not twist or pull the mount rubbera when installing.
- Offset measurements when each mount rubber is installed correctly.

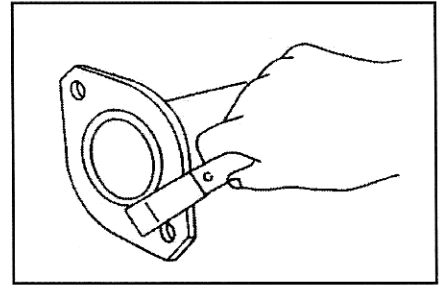

PARTS		X	Y	Z
Main muffler		-5~5	0~10	38~48
Centre muffler front		-5~5	0~10	38~48
Centre muffler rear	Right	33~43	-5~5	17~27
	Left	33~43	-5~5	17~27

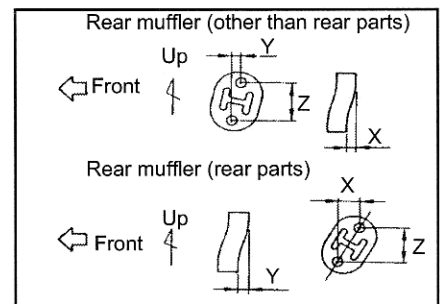

Inspection

- Start the engine and check for any gas leaks from each connection.
- Check for any exhaust gas leaks due to corrosion.
- Replace parts with new ones if there is a gas leak due to corrosion.

18. DUAL MODE MUFFLER**Removal**

1. Remove the battery negative terminal inside the boot.
 - (1) Open the boot lid.
 - (2) Remove the boot front finisher and remove the negative battery terminal.

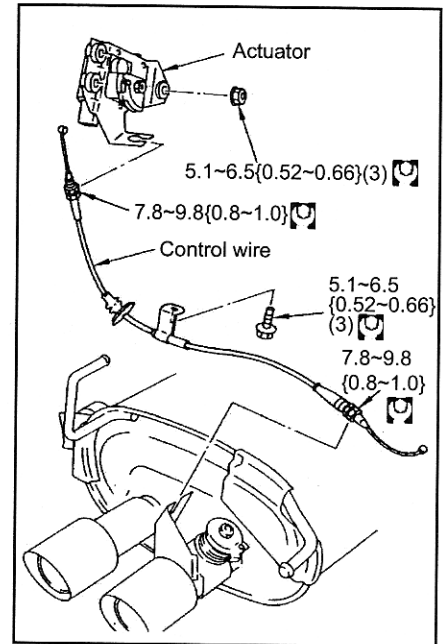

2. Remove the control wire.
 - First remove the actuator side then muffler side.
 - For the muffler side control wire, first remove from the mounting rubber then lower the rear end to remove the wire.

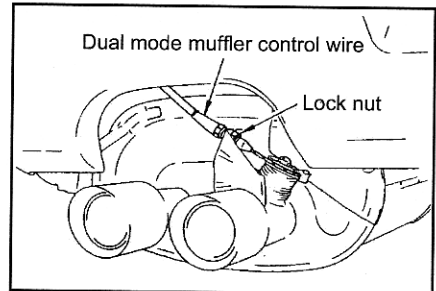

3. Remove the actuator.
 - Remove three installation nuts and remove the harness connector from behind the actuator. Then remove the actuator.

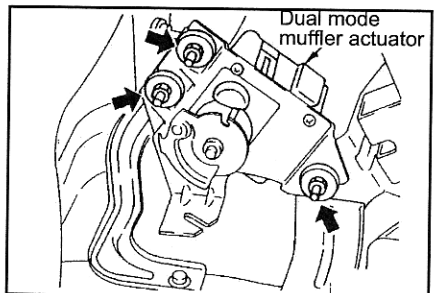
**Installation**

1. Install the actuator.
 - Connect the harness connector behind the actuator.
 - Tighten three installation nuts.
Tightening torque (N-m{kg-m}) 5.1~6.5{0.52~0.66}
2. Install the control wire to the main muffler side.
Tightening torque (N-m{kg-m}) 25~32{2.6~3.3}
3. Install the main muffler to the mount.
4. Temporarily connect control wire to the actuator.
 - Do not apply too much force to the wire.
5. Adjust the wire.

Adjustment

- To take up the slack from the inner wire, first loosen the wire bracket lock nut on the actuator side and then move the outer cable in the direction of the arrow.
- The outer cable will interfere with the wire drum if the outer cable is positioned excessively towards the actuator lever.
- If the inner wire is too tight, move the outer cable in the opposite direction to the arrow.

Caution:

The valve will be partially open if the wire is too tight.

- Inner wire adjustment.
Press down on the inner wire between the valve lever wire bracket and the tail tube wire bracket with a finger, the wire slack should be approx. 2mm.
 - Tighten the actuator side lock nut after the adjustment.
- Tightening torque (N-m{kg-m}) 7.8~9.8{0.8~1.0}

Inspection

- Make sure the valve is not half open when the ignition switch is in ON position. Check for any exhaust gas leaks from right side of the tail tube when idling.
- Check if the valve will open fully at approx. 4100rpm.

RB25DET ENGINE

1. INTER-COOLER (RB25DET)

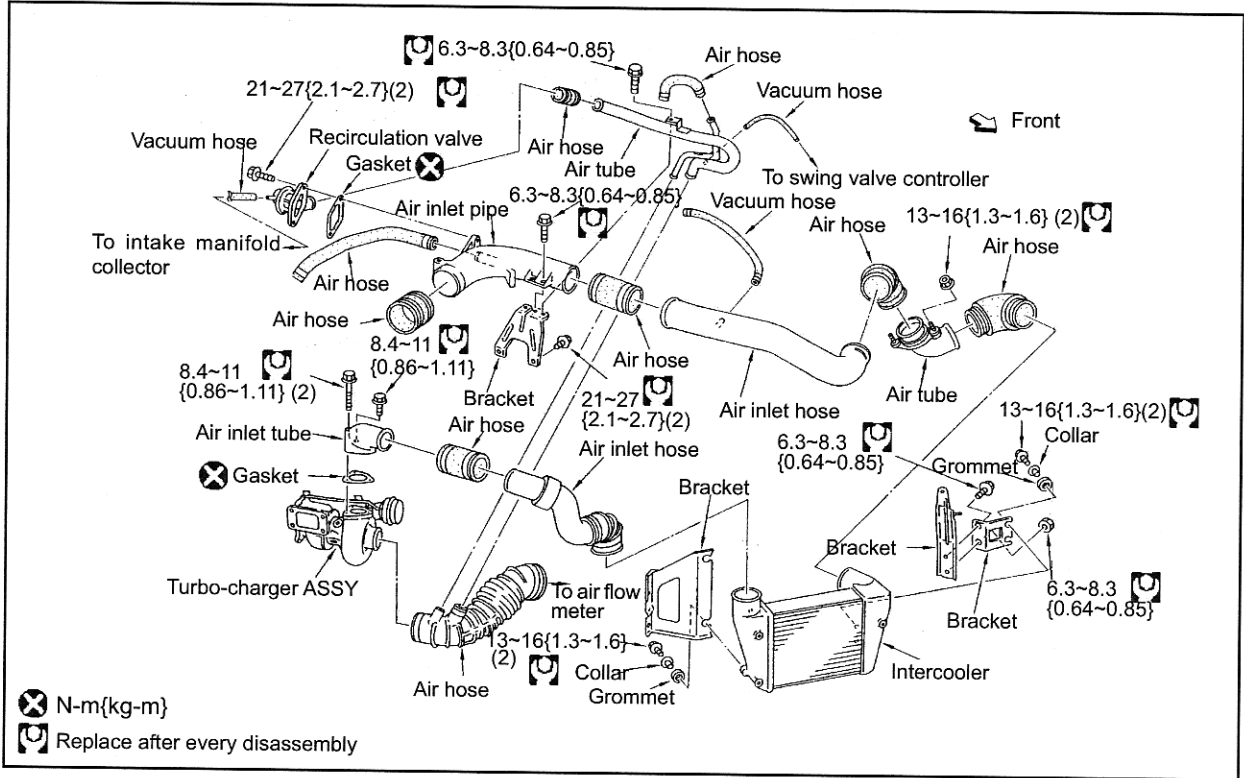

Removal

1. Remove the battery negative terminal.
 - (1) Open the boot lid.
 - (2) Remove the boot front finisher and remove the negative battery terminal.
2. Remove air duct and the air cleaner case.
3. Remove air inlet pipe and the air tube.
 - (1) Remove vacuum hose and the air hose.
 - (2) Remove the canister tube installation bolt (A), air inlet pipe installation bolt (B) and air tube installation bolt (C).
 - (3) Loosen each clamp to remove air inlet pipe and the air tube.
4. Remove the air inlet hose.
 - (1) Remove air hose and the vacuum hose from the boost control solenoid and air inlet hose.
 - (2) Place alignment marks as required and loosen each clamp to remove air inlet hose.
5. Remove inter-cooler.
 - (1) Remove the front fender protector (left).
 - (2) Remove 4 installation bolts shown.
 - (3) Loosen clamps on the air hose to remove inter-cooler.

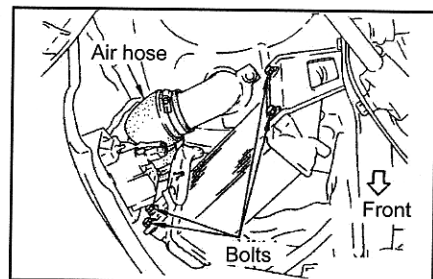
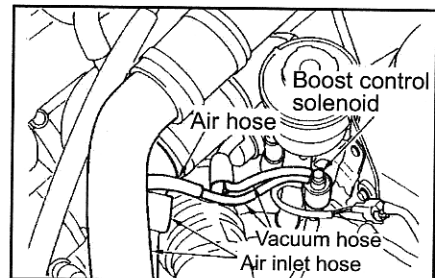
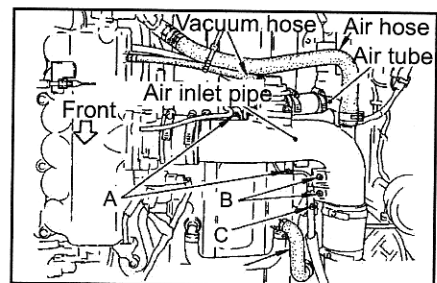

Inspection

Inter-cooler visual inspection

- Check inter-cooler for any damage or wear.
- Replace inter-cooler if there is any fault.

Recirculation valve

Function inspection

- Disconnect recirculation valve compressor upper end hose (place a hole cap). Check if the air will blow back when the throttle is closed.

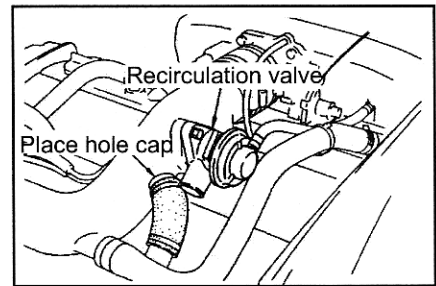

Element inspection

- Make sure the recirculation valve diaphragm will rise and the negative pressure is retained when the vacuum handy pump is used to apply negative pressure (-230+/-50mmHg).

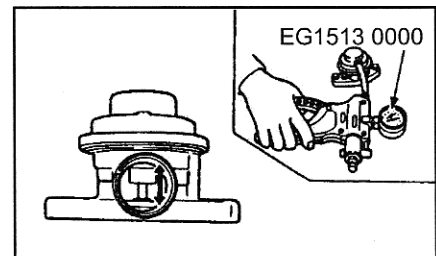
**Installation**

1. Install the inter-cooler.

(1) Tighten 4 installation bolts.

Tightening torque (N-m{kg-m}) 13~16{1.3~1.6}

(2) Tighten air hose clamps.

(3) Install front fender protector (left side).

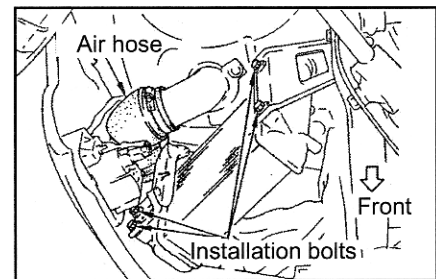

2. Install air inlet hose.

(1) Align the alignment mark to install the air inlet hose.

(2) Install three vacuum hoses boost control solenoid and air inlet hose.

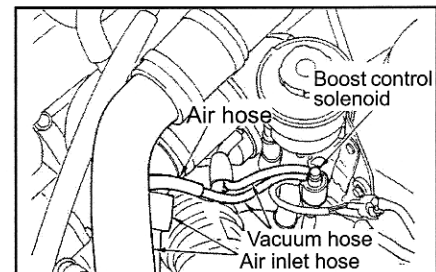

3. Install the air inlet pipe.

Tightening torque (N-m{Kg-m}) 6.3~8.3{0.64~0.85}

4. Install the air tube.

• Tighten installation bolt (C).

Tightening torque (N-m{kg-m}) 6.3~8.3{0.64~0.85}

5. Install the canister tube.

• Tighten installation bolt (A).

Tightening torque (N-m{kg-m}) 6.3~8.3{0.64~0.85}

6. Install the air hose and the vacuum hose.

7. Install the rest in reverse order to the removal procedure.

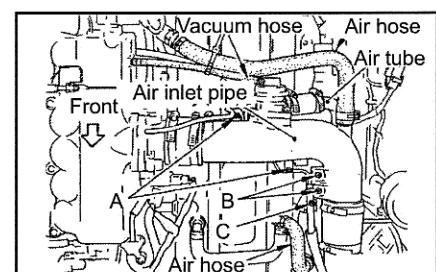

RB25DET ENGINE

2. TURBO-CHARGER

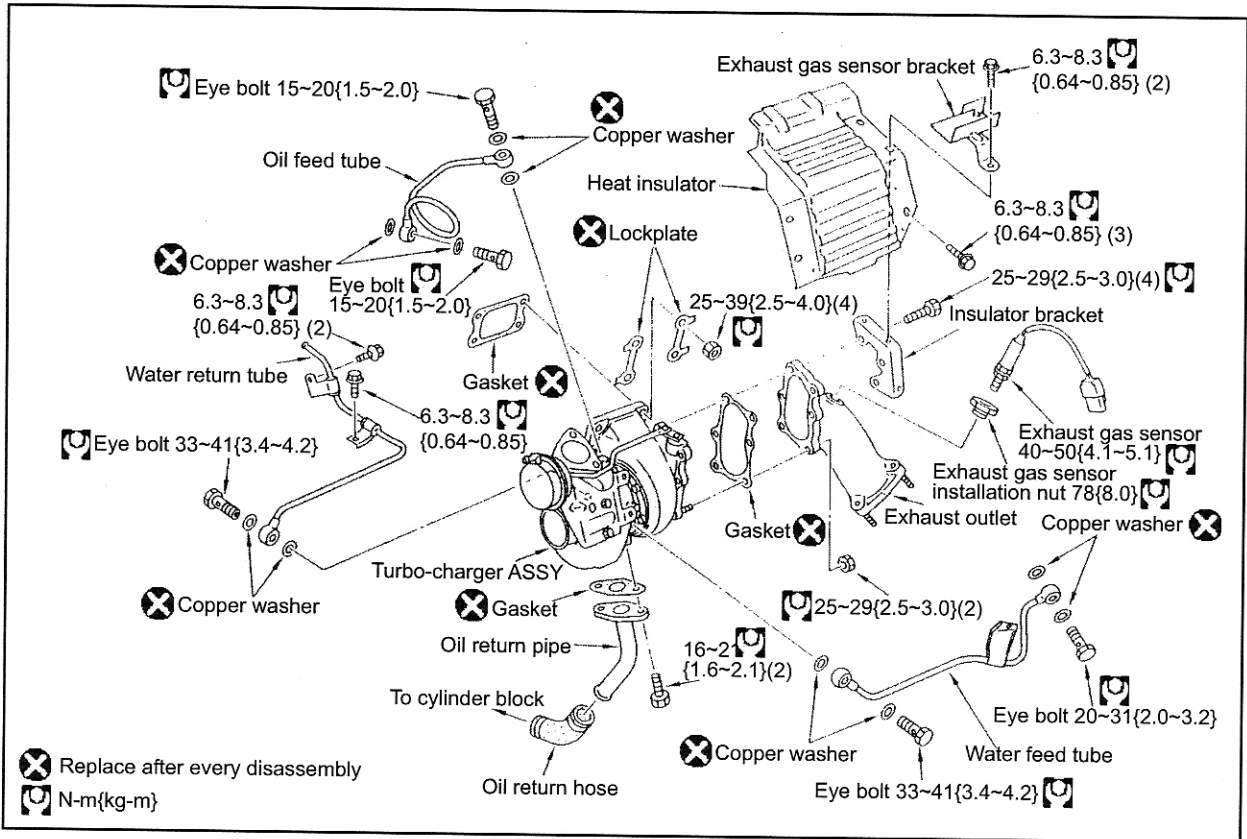

Removal

1. Remove the battery negative terminal.
 - (1) Open the boot lid.
 - (2) Remove the boot front finisher and remove the negative battery terminal.
2. Drain coolant from the radiator drain plug.
3. Remove the exhaust front tube.
4. Remove air inlet tube.
5. Remove air hose from the turbo-charger.
6. Remove swing valve controller from the vacuum hose.
7. Remove the earth wire.
8. Disconnect exhaust gas sensor connector.
9. Remove the heat insulator and exhaust gas sensor bracket.
10. Remove exhaust sensor.
 - Use exhaust sensor remover socket to remove.
 - Do not cause damage to exhaust sensor.
11. Remove water feed tube.
 - Drain coolant from an eye bolt on the water feed tube on the cylinder block side or from the cylinder block drain plug.
 - Remove two eye bolts and installation bolt.
12. Remove water return tube.
 - Remove eye bolt and two installation bolts.

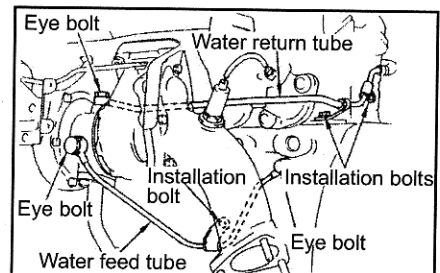
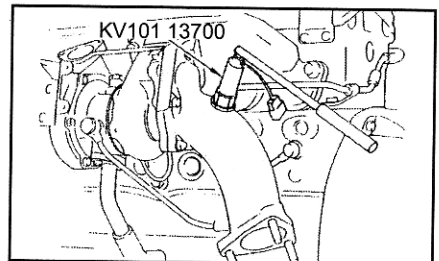
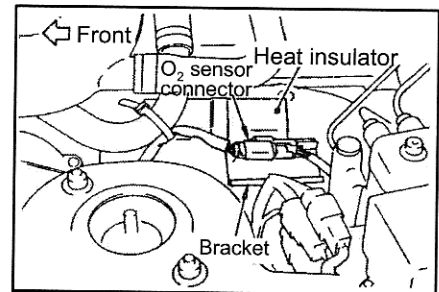

13. Remove oil feed tube.

- Remove two eye bolts.

14. Remove oil return pipe.

- Loosen oil return hose clamp to remove two installation bolts.

15. Remove exhaust outlet and the insulator bracket.

16. Lift up the claw to remove four turbo-charger installation nuts.

17. Remove the turbo-charger.

Warning:

Do not disassemble turbo-charger.

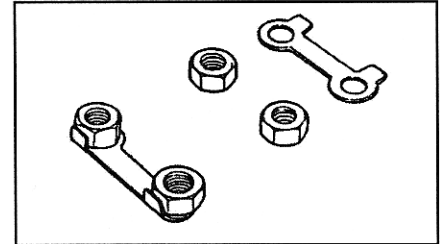
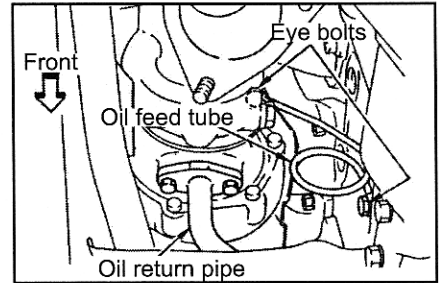

Inspection

Water feed / Return tube

Check to make sure there are no blockages or rust inside the water feed and the return tube by blowing in air using the air gun after cleaning the tube with radiator cleaner.

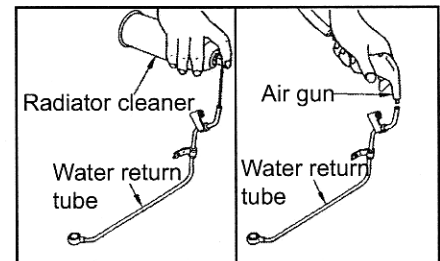

Oil feed / Return tube

Check to make sure there are no blockages or rust inside the oil feed and the return tube by blowing air in using the air gun after cleaning the tube with engine conditioner.

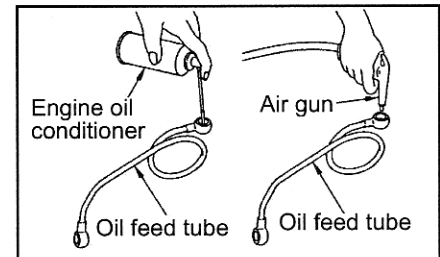

Turbo-charger

- Clean before inspection.
- Clean the oil feed and the oil return with engine conditioner.
- Clean the water inlet and outlet with radiator cleaner.

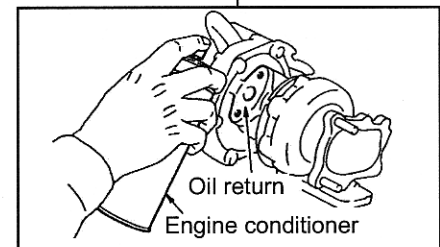

- After cleaning use the air gun to blow clean.
- Also blow air to the compressor wheel, turbine wheel, compressor housing and turbine housing.

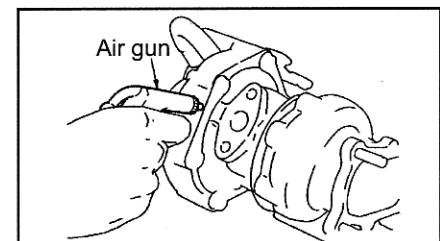

RB25DET ENGINE

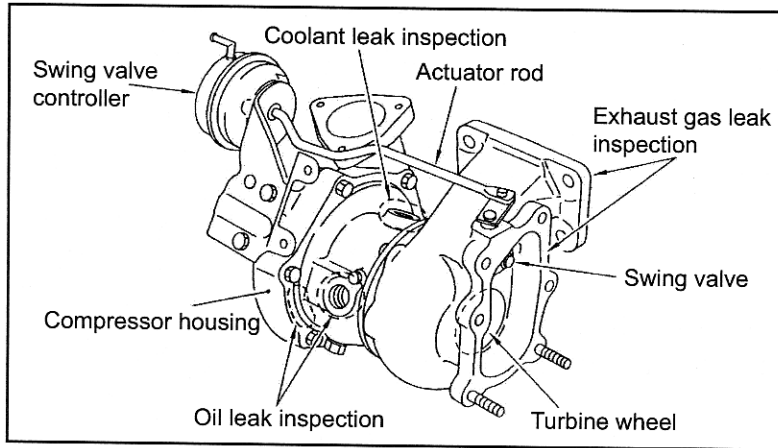

Rotor shaft

- Make sure the rotor shaft will turn smoothly when pushed with finger.
- The rotor shaft must not be loose when moved right / left.

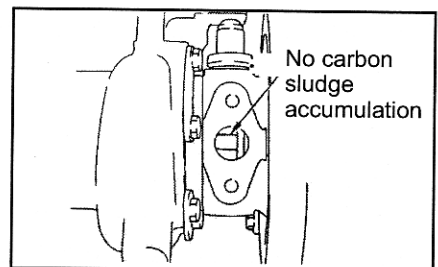
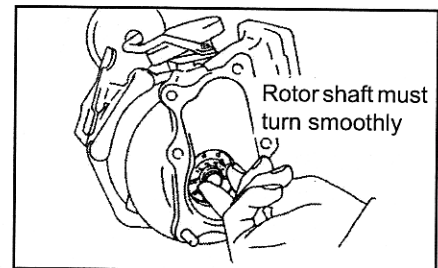

- Make sure there is no carbon sludge accumulation.
- Make sure there is no change in colour with the rotor shaft.

Rotor shaft end play

- Set end play by placing the dial gauge to the rotor shaft end and place it to the axle direction.
Standard value (mm) 0.120 ~ 0.200

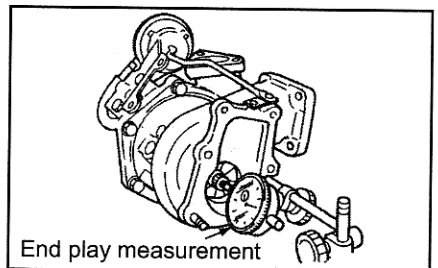

Turbine wheel

- Make sure there is no grease adhesion.
- Make sure there is no carbon accumulation.
- Make sure the turbine wheel blade is not bent or broken.
- Make sure there is no interference between the turbine housing and the wheel.

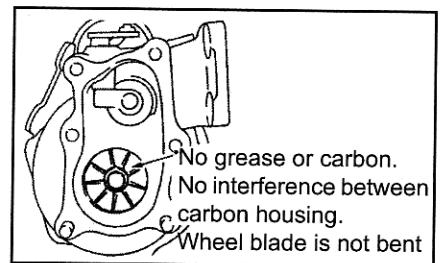

Swing valve

- Remove actuator rod E-ring and check if the swing valve will move smoothly with no deformation or damage.
- Check for any abnormality with the turbine housing seat surface.

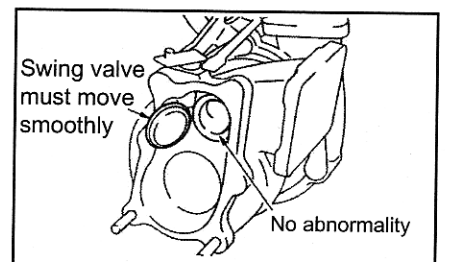

RB25DET ENGINE

Compressor wheel

- Make sure there is no grease adhesion at admission port.
- Check for any interference between the compressor housing.
- Make sure the wheel is not bent or damaged.

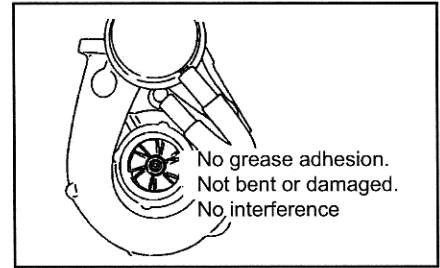

Swing valve controller

- Remove swing valve controller rubber hose at compressor housing side.
- Inspection must be carried out when actuator rod is installed and removed.
- Make sure the swing valve controller rod will move when the air gun is used to blow air in (approx. 51kPa{385mmHg} [M/T vehicle], approx. 36kPa{270mmHg} [A/T vehicle]). Stop air gun operation as soon as it starts moving.

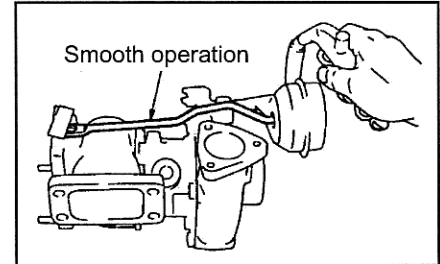
Caution:

Before blowing the air to the swing valve controller rod make sure to check the air gun pressure using the LPG pressure gauge (0.10MPa{1kg/cm²} ST1957 2000) so it will not damage the diaphragm.

Turbo-charger fault diagnosis (oil leak, smoke, lack of power, lack of acceleration, abnormal noise)

Points to be checked before diagnosis:

- (1) Level of engine oil is between MIN and MAX line (If the level is over the MAX line, the engine oil will flow into the intake duct causing a fault with the turbo-charger).
 - (2) Enquire the customer if the oil had been cooled down by idling the vehicle after driving.
- Referring to the table on the following page, replace the turbo ASSY if any of the unit tests are faulty.
 - If no fault is detected there is no fault with the turbo unit, inspect other vehicle parts.

Inspection parts	Inspection result	Phenomenon			
		Oil leak	Smoke	Noise	No power No Acceleration
Turbine wheel	Dirty with oil	▲	●	▲	▲
	Carbon accumulation	▲	●	○	○
	Interference with housing	▲	○	●	○
	Wheel is bent or broken			●	●
Compressor wheel	Inside the admission port is dirty with oil	○	○		
	Interference with housing	▲	○	●	○
	Wheel is bent or broken			●	●
Rotor shaft end play checking both turbine and compressor	Doesn't turn smoothly when pushed with a finger		▲	▲	○
	Doesn't turn when pushed with a finger				●
	Movement of the bearing is great	▲	▲	○	▲
Rotor shaft and oil return	Carbon sludge accumulation at scavenge hole	▲	●	▲	▲
Swing valve operation (use air gun)	Doesn't operate smoothly when correct air pressure is applied (Approx. 51kPa{385mmHg} [M/T vehicle], Approx. 36kPa{270mmHg} [A/T vehicle])				●

[● Extremely high ○ High ▲ Small]

Installation

- Install turbo-charger to the exhaust manifold.
 - Replace the gasket with a new one.
Tightening torque (N-m{kg-m}) 25~39{2.5~4.0}
 - After tightening the installation nut fold the lock plate claw towards the installation nut to fix the installation nut.
 - Replace the lockplate with a new one.
- Install the exhaust outlet and the insulator bracket.
Tightening torque (N-m{kg-m}) 25~29{2.5~3.0}
- Install the oil return pipe.
 - Replace the gasket with a new one.
Tightening torque (N-m{kg-m}) 16~21{1.6~2.1}
 - Tighten oil return hose clamp.
- Install the oil feed tube.
 - Replace the copper washer with a new one.

Caution:

The eye bolts for the oil feed tube are labelled "G" as they are different to other eye bolts.

Tightening torque (N-m{kg-m}) 15~20{1.5~2.0}

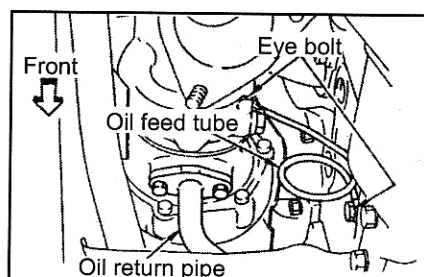
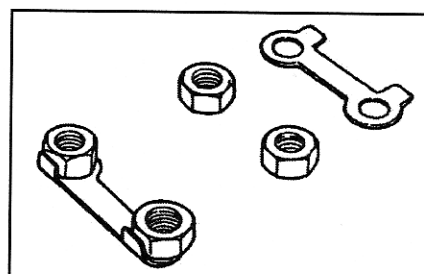

RB25DET ENGINE

5. Install the water return tube.

- Replace the copper washer with a new one.

Tightening torque (N-m{kg-m})

Installation bolt 6.3~8.3{0.64~0.85}

Eye bolt 33~41{3.4~4.2}

6. Install the water feed tube.

- Replace the copper washer with a new one.

Tightening torque (N-m{kg-m})

Turbo-charger side eye bolt 33~41{3.4~4.2}

Cylinder block side eye bolt 20~31{2.0~3.2}

7. Install the exhaust sensor to exhaust outlet.

- Use the exhaust sensor installation socket to install.

Caution:

Do not cause any damage to the exhaust sensor when installing.

Tightening torque (N-m{kg-m})

Exhaust sensor installation nut 78{8.0}

Exhaust sensor 40~50{4.1~5.1}

8. Install the heat insulator and the exhaust sensor bracket.

Tightening torque(N-m{kg-m}) 6.3~8.3{0.64~0.85}

9. Install the exhaust sensor connector and the ground wire.

10. Install the rest in reverse order to the removal procedure.

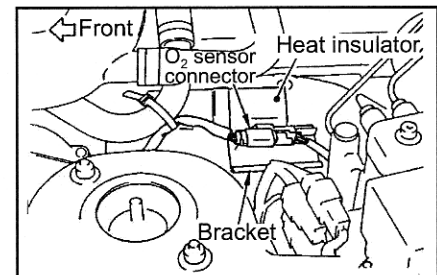
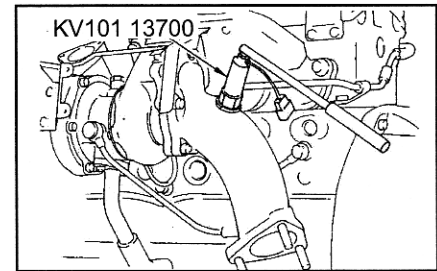
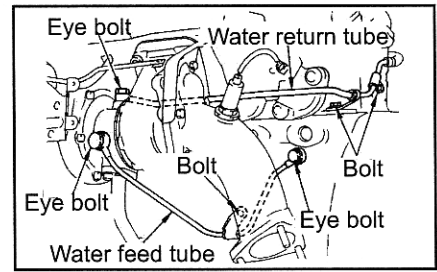

Inspection

- Start the engine and look for any leakage from the turbo-charger pipings such as coolant and engine oil. Also check exhaust manifold and the turbo-charger connection for any exhaust gas leak.

Turbo-charger function inspection

- Stop the engine after engine has warmed up.
- Connect three-way connector to the air hose between the air inlet pipe and the swing valve control and install the compound gauge.
- Start the engine and increase the engine rev. Read the maximum value on the compound gauge.

Swing valve opening pressure (kPa{mmHg})

M / T 49~54{365~405}

A / T (when lifting 0.38mm) 33~39{250~290}

- If the value is not within the standard value carry out the inspection below.

Compound gauge pointer	Inspection
Pressure is low / incorrect	<ul style="list-style-type: none"> • Air leak with breath system • Faulty turbo-charger
Doesn't increase swing valve opening pressure (standard value)	<ul style="list-style-type: none"> • Disconnected / broken swing valve controller hose • Non-operational swing valve controller

RB25DET ENGINE

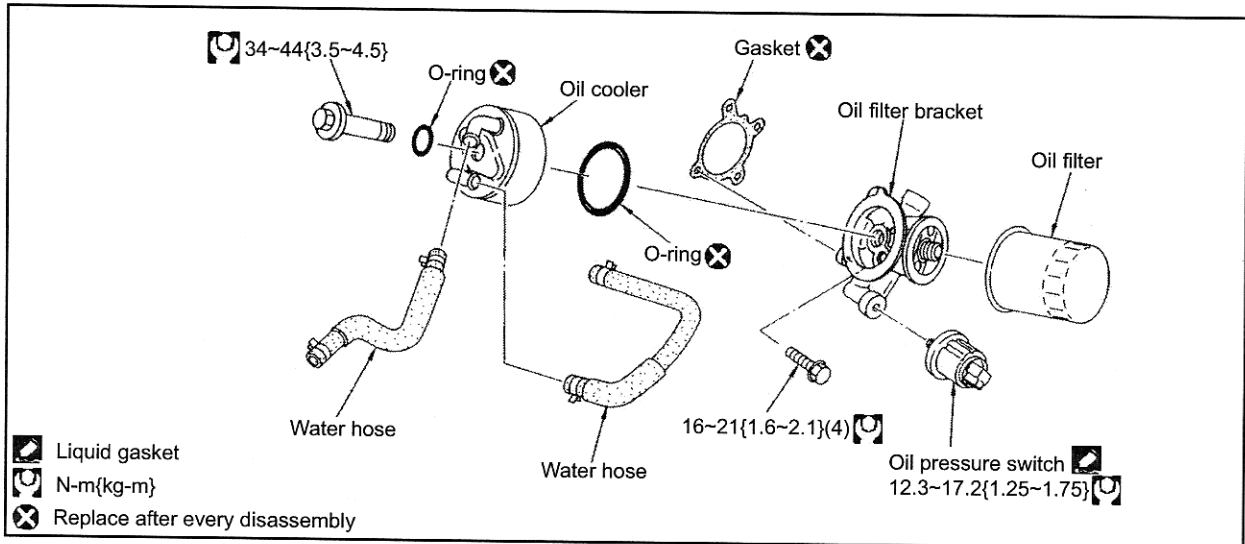
3. OIL FILTER BRACKET & OIL COOLER**Removal**

1. Remove the battery negative terminal.
 - (1) Open the boot lid.
 - (2) Remove the boot front finisher and remove the negative battery terminal.
2. Remove the under cover.
3. Drain coolant from the radiator drain plug.
4. Drain coolant from the cylinder block drain plug.
5. Remove the oil filter.
6. Disconnect two water hoses on the oil cooler side.
7. Remove the oil pressure switch connector.
8. Remove the oil filter bracket and the oil cooler ASSY.
9. Remove the gasket.

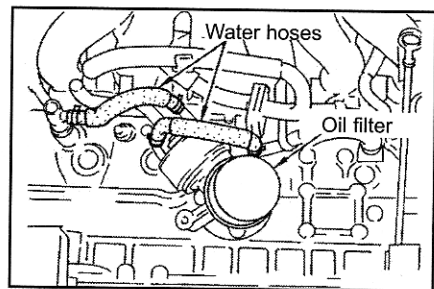
**Installation**

1. Install the oil filter bracket and the oil cooler ASSY.
 - Replace the gasket with a new one.
 Tightening torque (N-m{kg-m}) 16~21{1.6~2.1}
2. Install two water hoses.
3. Install the oil filter.
4. Install the rest in reverse order to the removal procedure.

Disassembly

1. Remove the oil pressure switch.
2. Remove the oil cooler from the oil filter bracket.

Inspection

Oil filter bracket visual inspection

- Check for any damage or wear.
- Replace the oil filter bracket if there is any abnormality.

Oil cooler inspection

- Check for any clogs in the oil cooler.
- Replace the oil cooler with a new one if there is any abnormality.

Assembly

1. Install the oil cooler to the oil filter bracket.
 - Replace the o-ring with a new one.
 - Align the oil cooler stopper to the oil filter bracket stopper and tighten the installation bolts.

Tightening torque (N-m{kg-m}) 34~44{3.5~4.5}
2. Install the oil pressure switch.
 - Apply sealing agent (KP510 00150) to the thread part then install.

Tightening torque (N-m{kg-m}) 12.3~17.2{1.25~1.75}

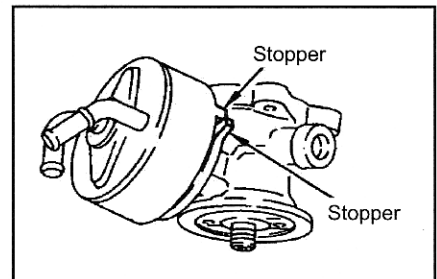

RB26DETT ENGINE

1. AIR CLEANER & AIR DUCT (RB26DETT)

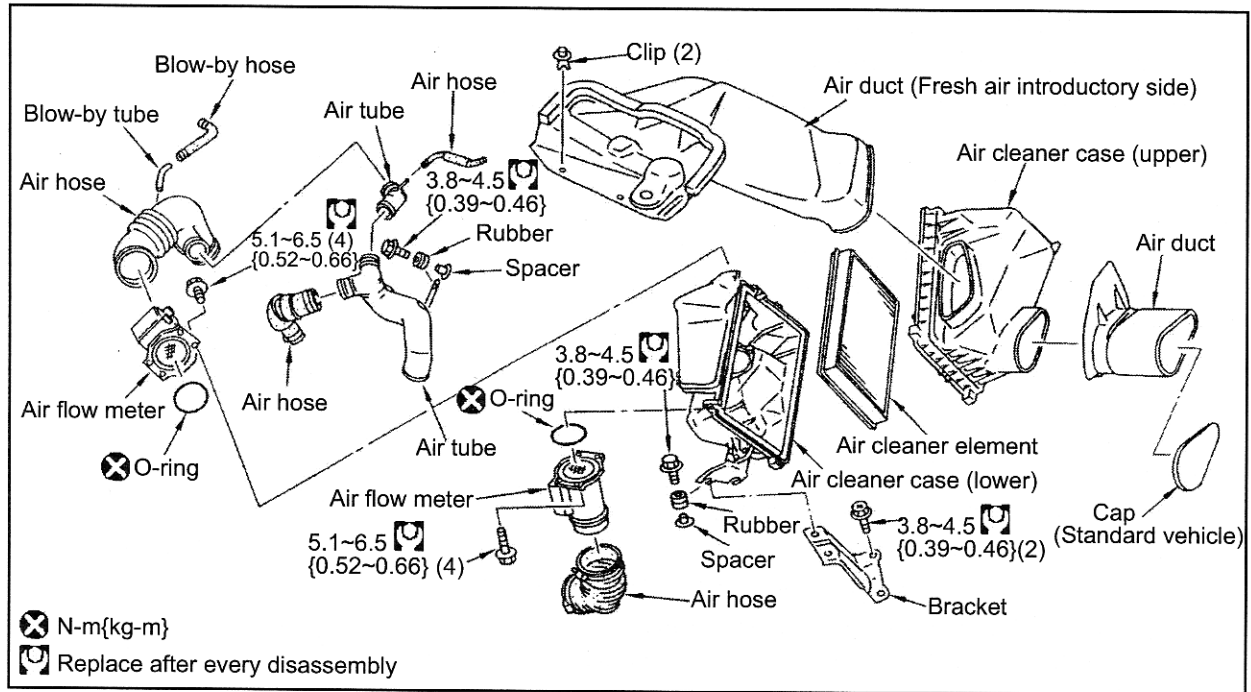
**Removal**

1. Remove negative battery terminal.
 2. Use air gun to remove any rubbish, dust etc. from the air cleaner area to avoid foreign objects entering the duct.
 3. Remove the air duct (fresh air introductory side) clips.
 4. Remove the air duct (left fender side) from the air cleaner case (upper) and push it towards the vehicle side.
 5. Remove the air cleaner case (upper).
 - Remove 4 clips and loosen the installation bolts.
 6. Remove the air cleaner element.
 7. Remove the air cleaner case (lower).
 8. Remove each air hose and the air tube.
 - Disconnect each air hose and the air tube.
 - Place alignment marks as necessary at each connection part and loosen the clamps to remove.
- Loosen air tube installation bolt.
 - Remove the air hose and the blow-by hose.
 - Place alignment marks as necessary at each connection part and loosen the clamps to remove.

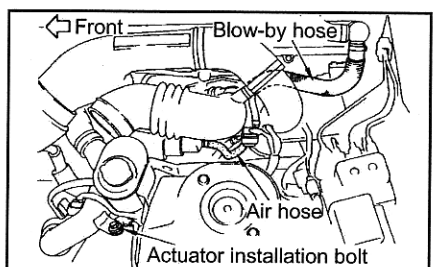
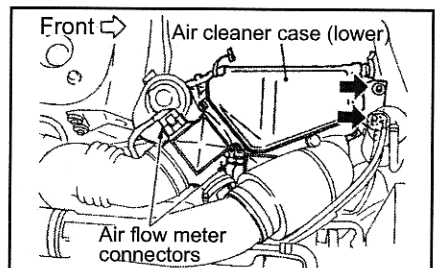
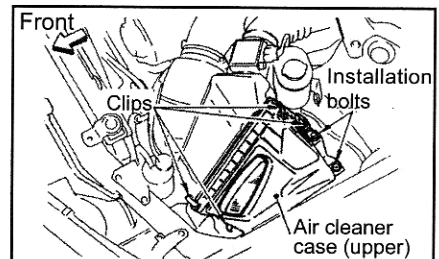
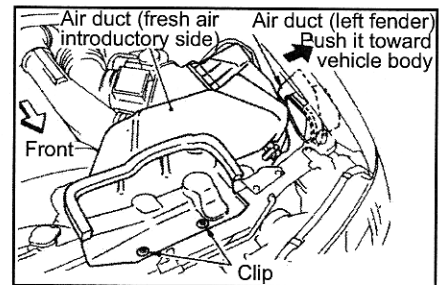

Inspection

- Check to make sure the air cleaner case, the air duct, air hose, air tube and blow-by hose is not damaged or worn in any way.
- Replace the parts with new ones if any abnormality is found.

Installation

1. Install the rest in reverse order to the removal procedure.
- Align the parts to alignment marks and install each air hoses and the air tubes.
 - Tighten each clamp securely.

RB26DETT ENGINE

- (4) Remove installation bolts and two installation nuts on lower front side of the inter-cooler.

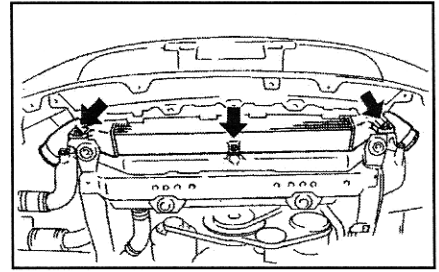

- (5) Remove right and left installation bolt and installation nuts on the inter-cooler installation bracket.
- (6) Remove right and left inter-cooler installation bracket and right and left sub bracket.
- (7) Remove inter-cooler and the recirculation tube.

Caution:

Care must be taken not to damage inter-cooler core.

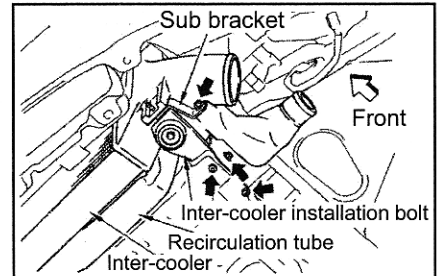

7. Remove the recirculation valve.

- (1) Remove the air hoses and the air tubes between recirculation tube and the recirculation valve outlet.
- (2) Remove the air hose at recirculation valve inlet.
- (3) Remove the inter-cooler right side air hose.

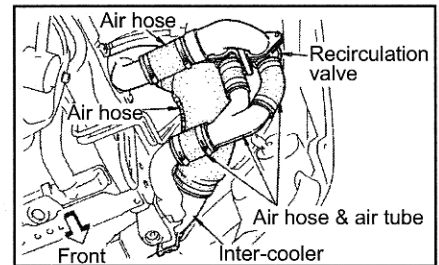

- (4) Remove two vacuum hoses at recirculation valve side.

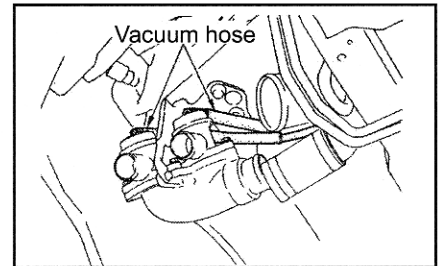

- (5) Remove three installation bolts to remove recirculation valve and air tube ASSY.

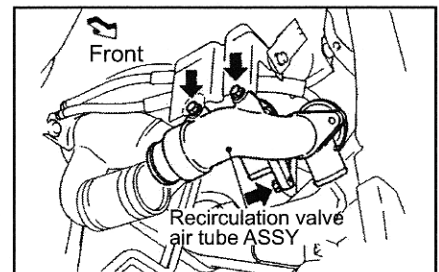

- (6) Remove the recirculation valve from the air tube.

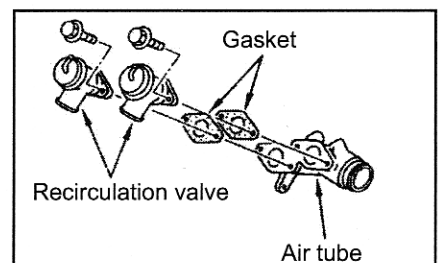

RB26DETT ENGINE

Inspection

Inter-cooler visual inspection

- Check to make sure inter-cooler core is not clogged with foreign objects.
- Check if there is any damage or faults at joints on the inter-cooler core and pipings.
- Clean if there are any blockages.
- Replace the inter-cooler if there is any damage or faults.

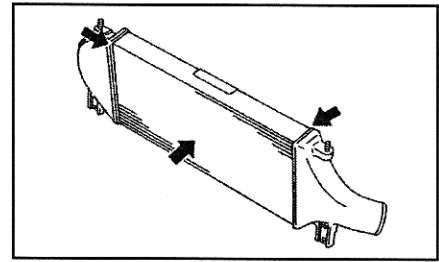

Recirculation valve function inspection

1. Remove the air hose and the air tube on recirculation valve output side.
 2. Place a hole cap on the recirculation side opening.
 3. Start the engine.
 4. Check the air blowout from the recirculation valve when the throttle is closed. It is normal if there is blowout.
- Check the vacuum hose for any disconnection or cut.
 - If there is no fault with the vacuum hose, carry out the recirculation valve operation check.

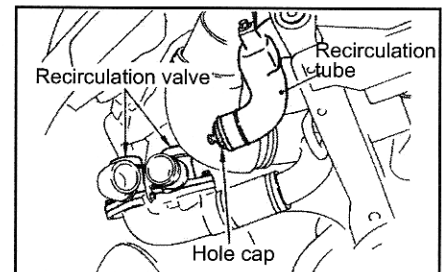

Recirculation valve operation inspection

- Use a vacuum hand pump to create negative pressure. Check if the valve will lift up to retain negative pressure.
- Standard value (kPa{mmHg} -16~-24{-120~-180})
- Replace the recirculation valve if there is any abnormality.

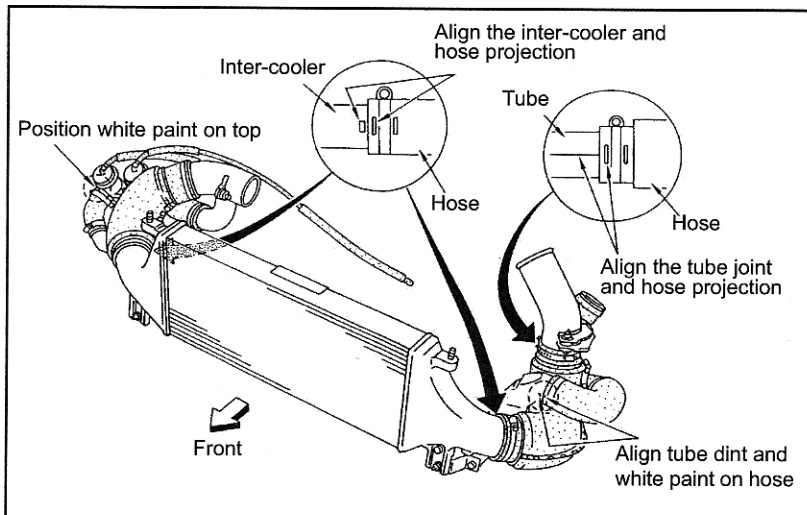
Installation

RB26DETT ENGINE

1. Install the recirculation valve.

- (1) Install the recirculation valve to the air tube.
 Tightening torque(N-m{kg-m}) 16~21{1.6~2.1}

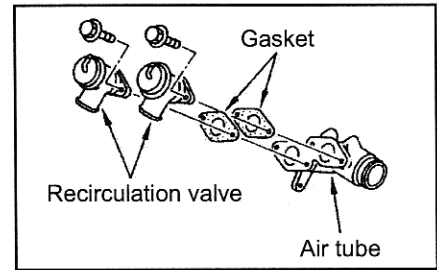

- (2) Install the recirculation valve and air tube ASSY.
 Tightening torque(N-m{kg-m}) 16~21{1.6~2.1}
- (3) Connect the air hose and the vacuum hose.
- Reinstall the parts by using the alignment marks.
 - Install the clamp securely.

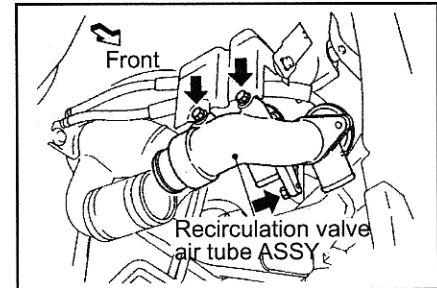

2. Install the inter-cooler.

- (1) Install the mount rubber on upper right and left side of the inter-cooler to the bracket.
- (2) Set the inter-cooler and the recirculation tube to installation position.
- Temporarily tighten the installation bolt at lower front side of the inter-cooler so it can be handled as a single unit.
 - Securely insert the inter-cooler upper right and left projection to the mount rubber.

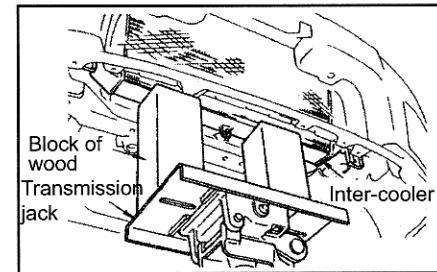

Caution:

- Care must be taken not to damage the inter-cooler core.
- The mount rubber may fall off if the inter-cooler is moved around excessively.

- (3) Install the inter-cooler installation bracket (right and left) and the sub bracket (right and left).

- Temporarily tighten all installation nuts and bolts. When the installation position is correct fully tighten the nuts and bolts securely from the bracket side.
- Tightening torque (N-m{kg-m}) 6.3~8.3{0.64~0.85}

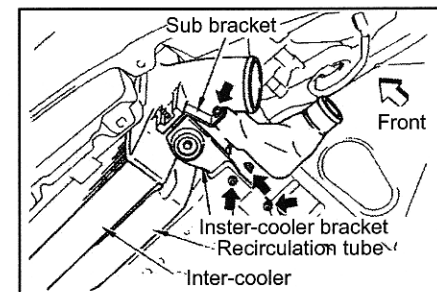

- (4) Tighten installation bolt and two nuts on front lower side of the inter-cooler.

Tightening torque (N-m{kg-m}) 16~21(1.6~2.1)

- (5) Connect the air hose.

- Reinstall the parts by using the alignment marks.
- Install the clamp securely.

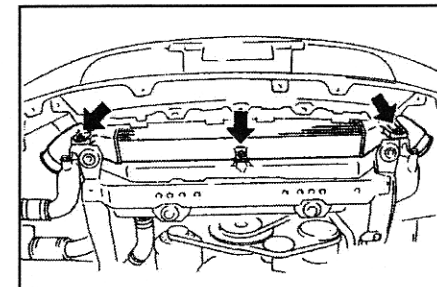

3. Install the rest in reverse order to the removal procedure.

3. FUEL INJECTOR

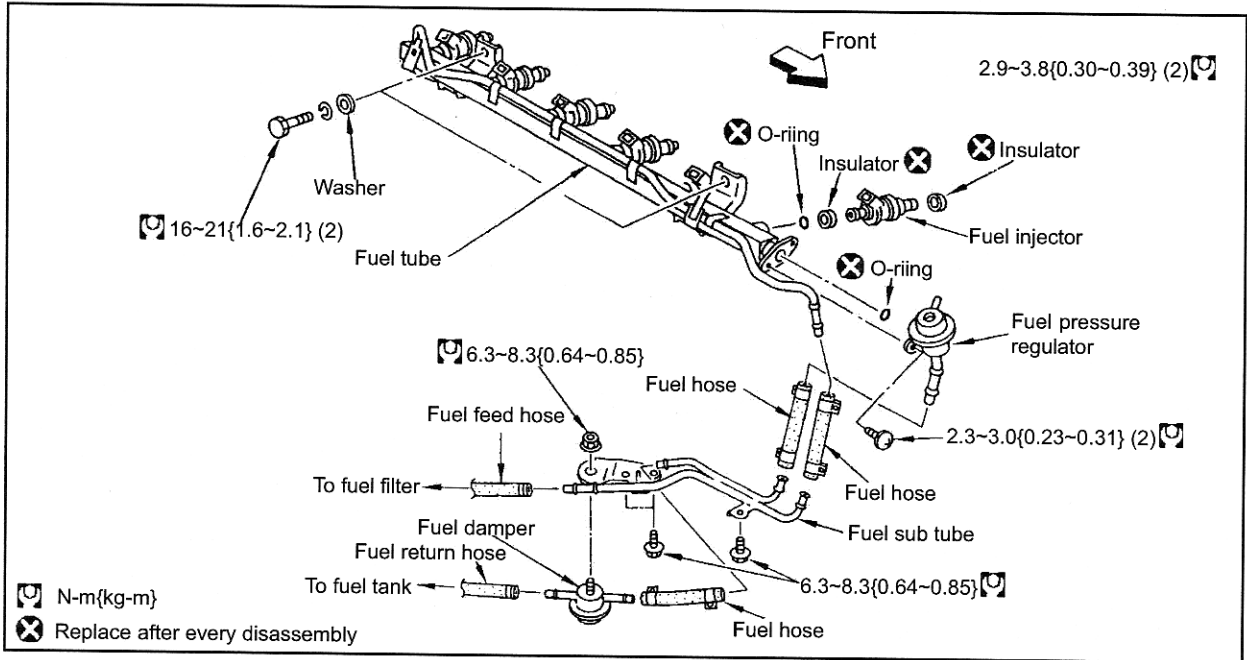

Removal

1. Release the fuel pressure.
2. Remove the battery negative terminal.
3. Remove the blowby hose between the rocker cover and the intake manifold.
4. Remove the vacuum hose for brake booster and the clutch booster.
5. Disconnect the following:
 - Throttle sensor
 - Throttle valve switch
 - Intake air temperature sensor
 - Knock sensor
 - Fuel injector
6. Remove the vacuum hose at the pressure regulator side.
7. Remove the fuel hose for feed and return at fuel tube side.

Caution:

Place the hole cap as soon as possible so the fuel will not leak.

8. Remove two installation bolts to remove fuel tube and fuel injector ASSY.

9. Remove fuel injector and the pressure regulator.
 - Pull them from the fuel tube straight.

Caution:

- Place a tray to catch leaking fuel from the fuel tube.
- Do not disassemble the fuel injector.
- Fuel injector must be handled carefully.

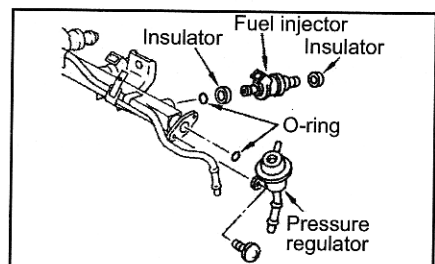
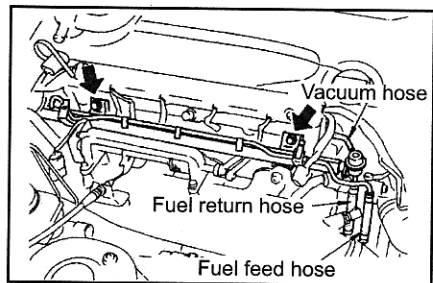
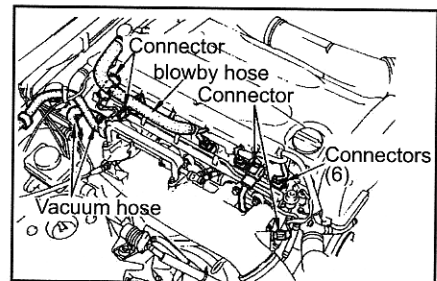

RB26DETT ENGINE

10. Remove fuel sub tube and fuel damper ASSY from behind the intake manifold collector.

Inspection

Fuel tube and fuel hose

- Check for any fuel leaks from the fuel tube and the fuel hose.
- Replace with new ones if there is any abnormality.

Installation

1. Install the fuel sub tube and fuel damper ASSY.
Tightening torque(N-m{kg-m}) 6.3~8.3{0.64~0.85}
2. Install the fuel injector to the fuel tube.
(1) Install o-ring and the insulator to the fuel injector.
 - Replace the o-ring and the insulator with new ones.
 - Read the handling note before carrying out this operation.

Handling note:

- Always handle the O-ring with bare hand (no gloves).
- Only apply engine oil (7.5W-30 or similar viscosity) and never clean or soak the o-ring in solvent solution.
- Avoid using dirty o-ring and devices with dust or other foreign objects adhered to it.
- When installing the o-ring care must be taken not to scratch the o-ring with tools or nails. Also do not twist or stretch them.
- When inserting fuel injector, pressure regulator or fuel damper into the fuel tube, do not twist or turn the parts.

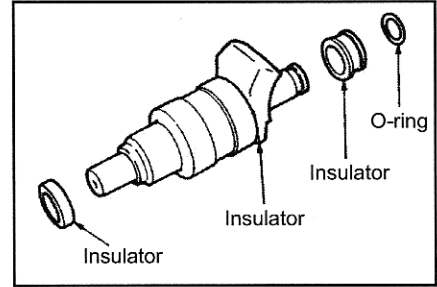

- (2) Install the fuel injector to fuel tube.
 - Care must be taken not to damage the nozzle tip.
3. Install the fuel pressure regulator.
 - Replace the o-ring with a new one.
Tightening torque (N-m{kg-m}) 2.3~3.0{0.23~0.31}
4. Install the fuel tube and fuel injector ASSY.
 - Tighten right and left fuel tube installation bolts alternately.
 - Replace the insulator with a new one.
 - When installing the washer face the flat side towards the fuel tube.
5. Install the fuel feed and the return hose.
 - Insert the hose tip up to the second bulged part of the fuel tube and make sure to securely tighten the clamp.
6. Connect the vacuum hose to the pressure regulator.
7. Install the rest in reverse order to the removal procedure.

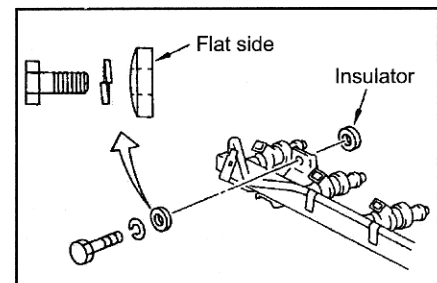
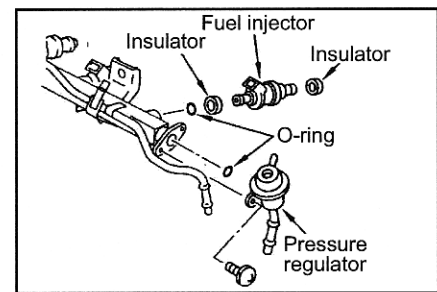

4. INTAKE MANIFOLD COLLECTOR

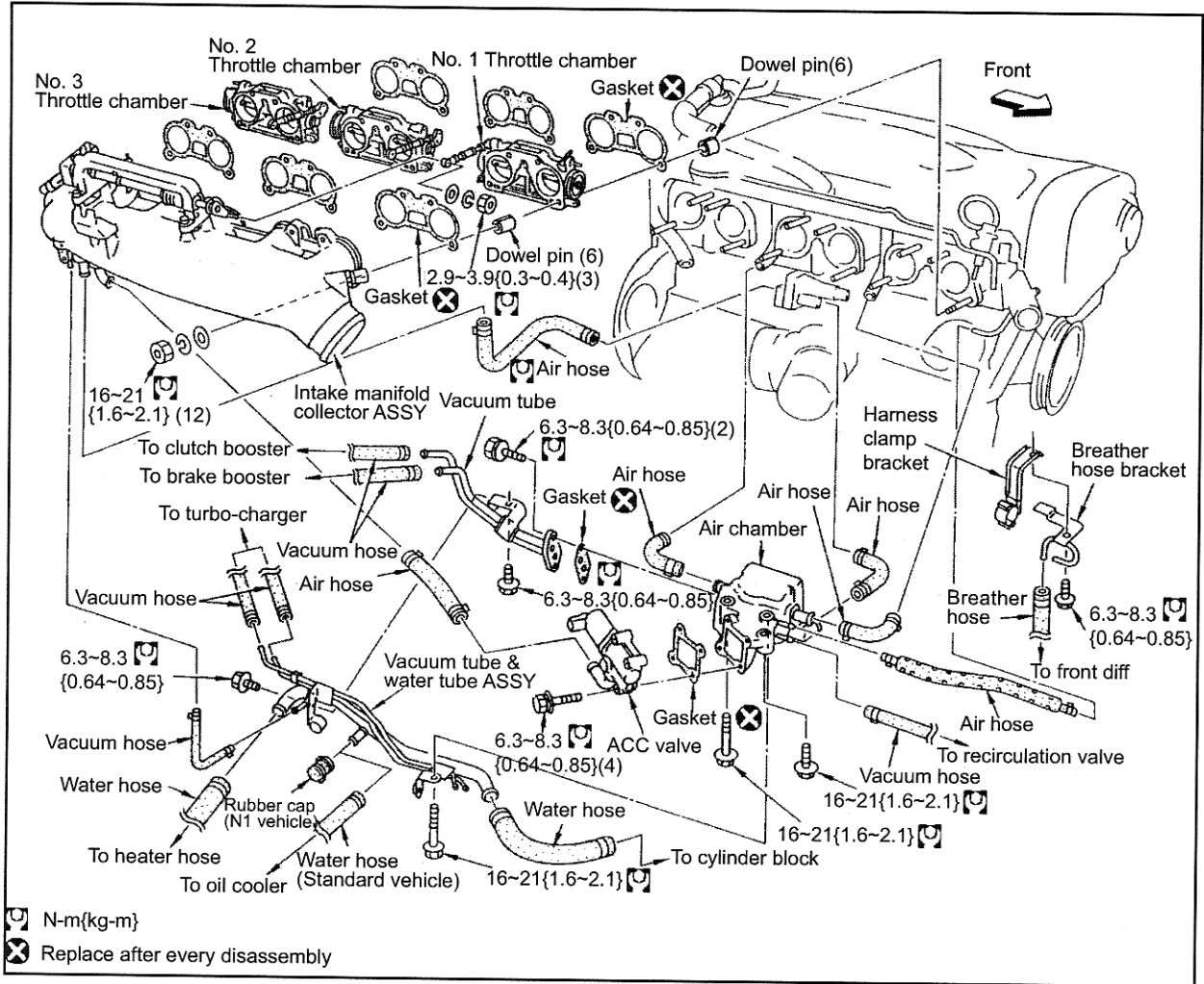

Removal

1. Release the fuel pressure.
2. Remove the negative battery terminal.
3. Drain coolant from the radiator drain plug.
4. Remove the front strut tower bar.
5. Remove the acceleration cable.
6. Remove the oil level gauge.
7. Remove the air hose at intake manifold collector inlet side.
8. Remove the blowby hose between the rocker cover and the intake manifold. (Labelled A)
9. Remove the vacuum hoses for the brake booster and the clutch booster. (Labelled B & C)
10. Disconnect two vacuum hose at boost control solenoid side. (Labelled D)
11. Remove connectors stated below:
 - Throttle sensor (Labelled E)
 - Throttle valve switch (Labelled F)
 - Intake air temperature sensor (Labelled G)
 - Knock sensor (Labelled H)

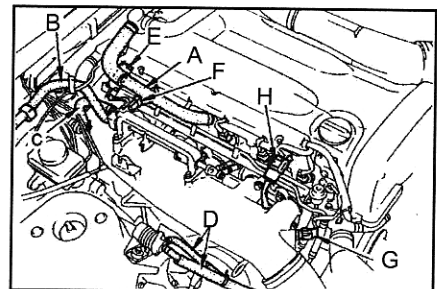

RB26DETT ENGINE

12. Disconnect the throttle link at the accelerator work unit side.
13. Remove the vacuum hose at No. 1 throttle chamber side.
14. Remove both fuel hoses (feed & return) at the fuel sub tube.

Caution:

Place a hole cap so the fuel will not leak.

15. Position the fuel filter and bracket ASSY to a position that will not get in the way.

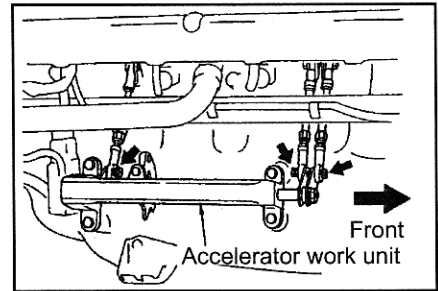

Reference:

Parts and installation bolts position on reverse side of the intake manifold collector are shown in the figure below.

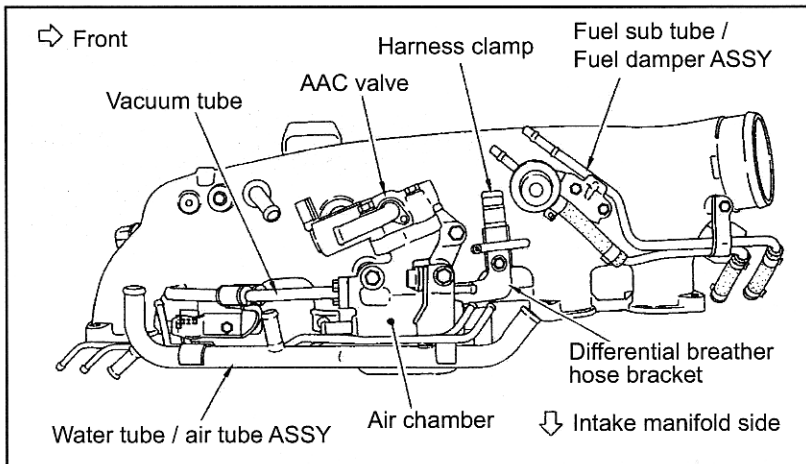

16. Remove the engine harness between the relay case and the starter motor from the clamp after opening the clamp .

17. Remove the fuel sub tube and fuel damper ASSY.

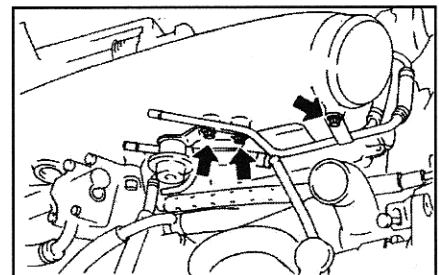

18. Remove the differential breather hose bracket and the harness clamp bracket.
19. Disconnect the AAC valve connector.
20. Disconnect the air hoses A, B and C at intake manifold collector side.

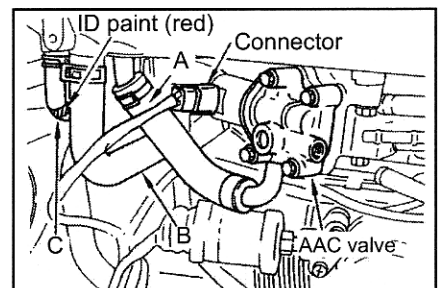

21. Remove the vacuum tube.

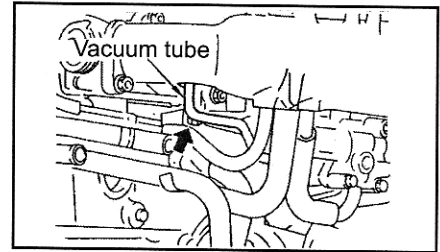

22. Remove the air chamber installation bolt.

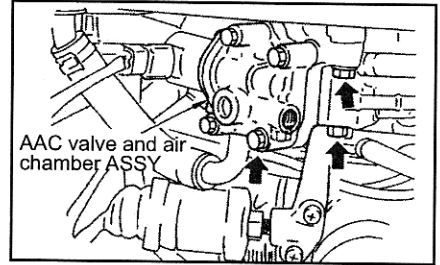

23. Remove the intake manifold.

- Loosen the installation nuts in the order shown in the figure on right.

Caution:

Care must be taken not to bend the throttle link.

24. Remove the throttle chamber.

- First check No.2 (center) and No.3 (rear side) before removing.

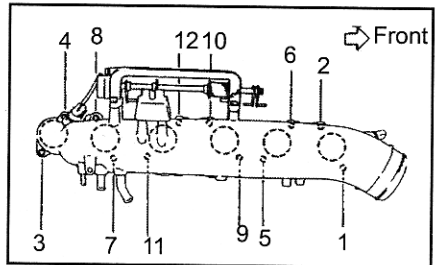

25. Remove each hoses (A ~ F) to remove the AAC valve and air chamber ASSY.

- Place alignment mark as necessary.

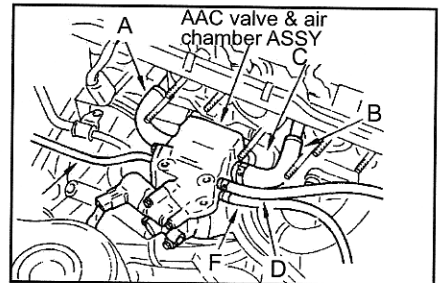

26. Remove the AAC valve from the air chamber.

Caution:

- Do not disassemble AAC valve.
- Care must be taken not to damage the AAC valve.

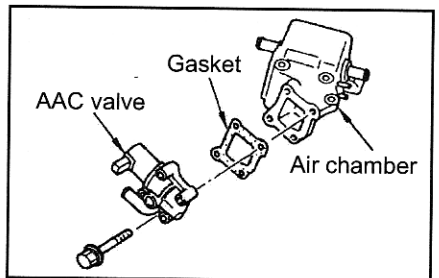

27. Disconnect each hose to remove the water tube and air tube ASSY.

Inspection

Distortion of the intake manifold collector

- Use a straight gauge and feeler gauge to measure the distortion in six directions.

Limit value (mm) 0.15

- If the distortion is over the limit replace with a new one.

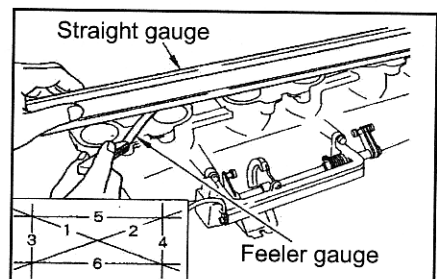

Installation

1. Connect hose to water tube and air tube ASSY.
 - Check the colour of identification paint when connecting the vacuum control hose to intake manifold collector rear end.
 - Make sure the clamp is installed securely.

Reference:

- (1) The vacuum control hose between the standard vehicle and N1 vehicle is different.
- (2) The vacuum control hose must be installed in the correct direction as it has an opening.

2. Install AAC valve to the air chamber.
 - Replace the gasket with a new one.
 - Tightening torque (N-m{kg-m}) 6.3~8.3{0.64~0.85}

3. Connect hose to the AAC valve and air chamber ASSY.
 - Remove old gasket from the vacuum installation surface and clean the surface using white gasoline before connecting the hose.
 - Make sure to install the clamp securely.

4. Install the throttle chamber.
 - (1) Remove old gasket from the intake manifold and the throttle chamber and clean the surface using white gasoline.
 - Clean the intake manifold collector side for the throttle chamber.
 - (2) Install dowel pin to the intake manifold lower stud bolts (6).
 - The length of the dowel pins are different for the throttle chamber and the intake manifold collector.

Length of the dowel pin (mm)	
For throttle chamber installation	10
For collector installation	14
 - (3) Install the gasket.
 - (4) Install the throttle chamber.
 - Make sure all three will contact the intake manifold when pushed.

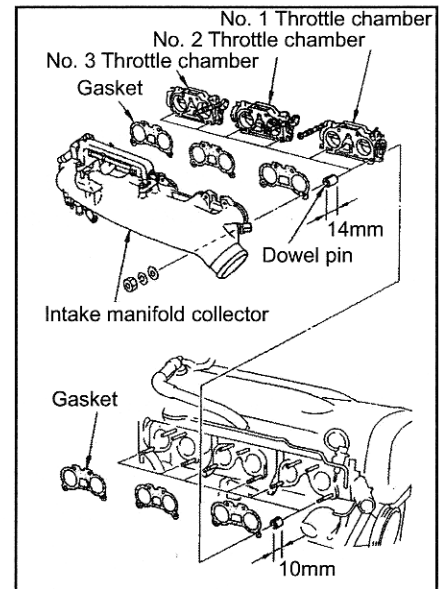
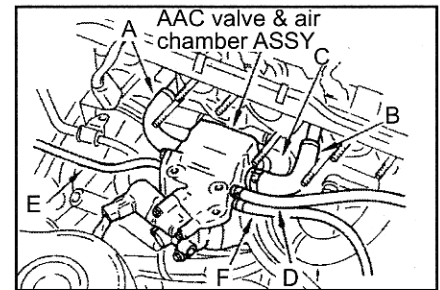
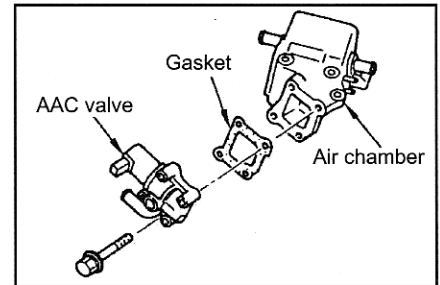
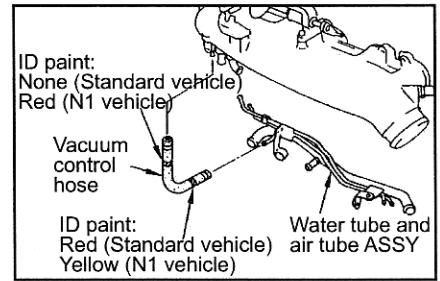

RB26DETT ENGINE

5. Install the intake manifold collector.

- (1) Remove old gasket from the intake manifold and collector and clean the surface using white gasoline.
- (2) Install the dowel pin to six stud bolts on the throttle chamber lower side.

- The length of the dowel pins are different for throttle chamber and the intake manifold collector.

Length of the dowel pin (mm)

For throttle chamber installation 10

For collector installation 14

(3) Install the gasket.

- Replace the gasket with new ones.

(4) Install the intake manifold collector.

- Tighten the installation nuts in the order shown in several stages.

Tightening torque (N-m{kg-m}) 16~21{1.6~2.1}

Caution:

Care must be taken not to bend the throttle link.

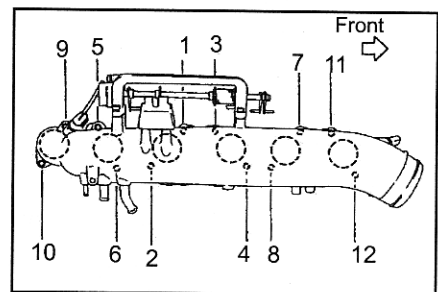

6. Install the air chamber installation bolts.

- For installation bolts position, refer to a diagram on intake manifold collector reverse side diagram on 4. Intake manifold section.

Tightening torque (N-m{kg-m}) 16~21{1.6~2.1}

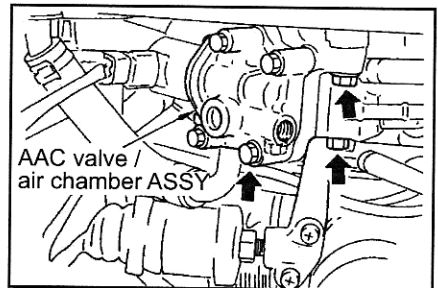

7. Install the vacuum tube.

- Replace the gasket with a new one.

Tightening torque (N-m{kg-m}) 6.3~8.3{0.64~0.85}

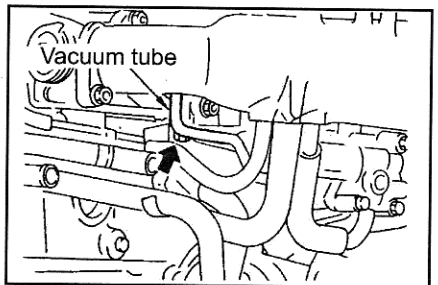

8. Install hose A, B and C to the intake manifold collector.

- When installing the vacuum control hose C, identification paint (red) should be on the intake manifold collector side (N1 vehicle).
- Make sure the clamp is installed securely.

9. Install the AAC valve connector.

10. Install the differential breather hose bracket and the harness clamp bracket.

Tightening torque (N-m{kg-m}) 6.3~8.3{0.64~0.85}

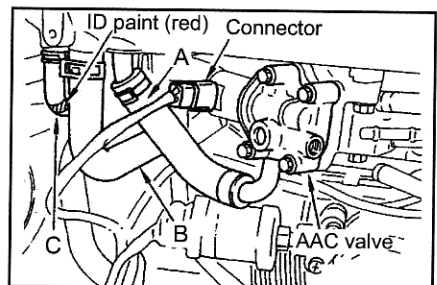

RB26DETT ENGINE

11. Install the fuel tube and fuel damper ASSY.

Tightening torque (N-m{kg-m}) 6.3~8.3{0.64~0.85}

12. Install the fuel hose.

- Insert the hose tip up to the second bulged part then tighten the clamp securely.

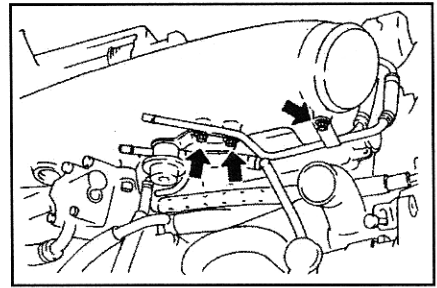

13. Install the throttle link to the accelerator work unit.

Tightening torque (N-m{kg-m}) 2.9~3.9{0.3~0.4}

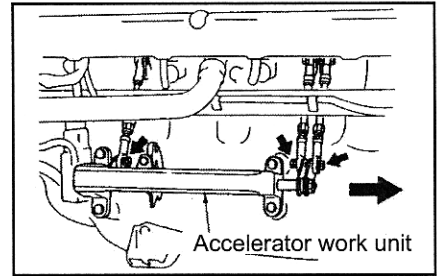

14. Carry out the method below to adjust the throttle chamber link when you have replaced any parts which will have affect on the way the throttle valve opening and closing motion or when there are any abnormality with the throttle valve opening and closing motion.

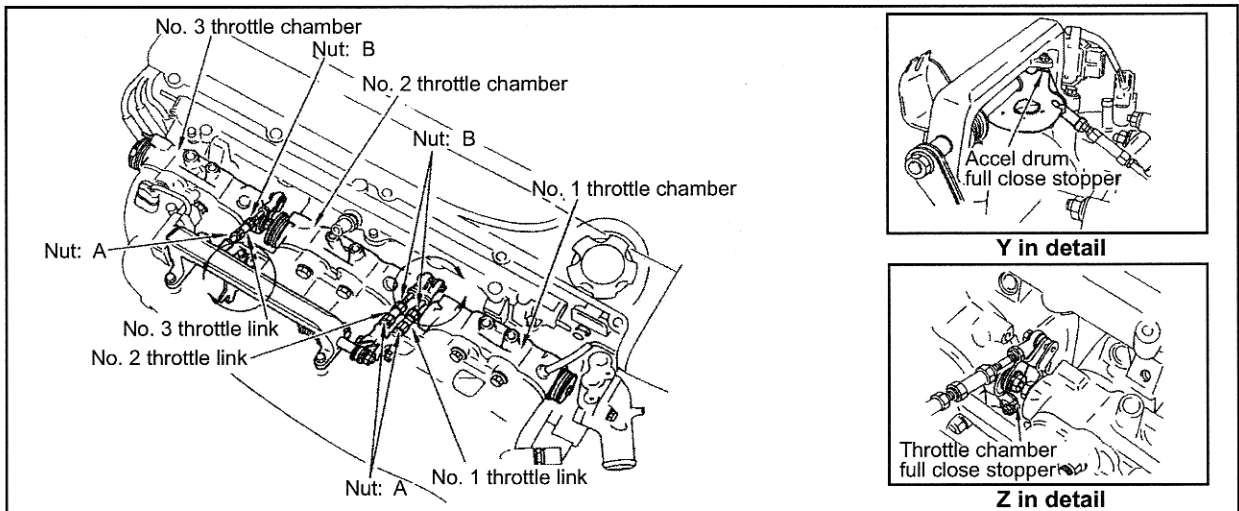

(1) Loosen each throttle link nut A and B and turn each throttle link centre adjustment part anti-clockwise to shorten the links.

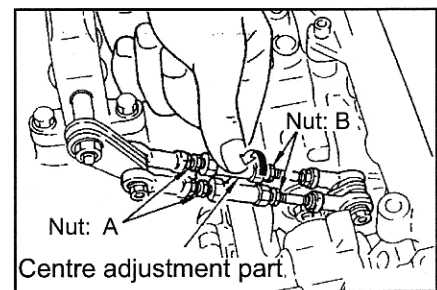

- Shorten each throttle link until the accelerator drum hit the full close stopper on the accelerator work unit side.

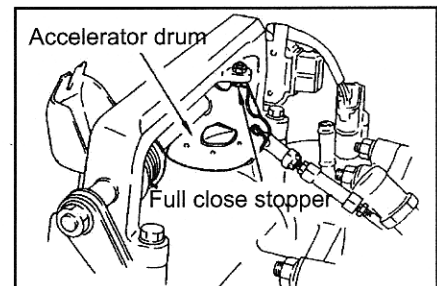

RB26DETT ENGINE

- (2) shorten each throttle link so the throttle lever will open from full close stopper on the throttle chamber side.

Caution:

Nut A and B do not lock.

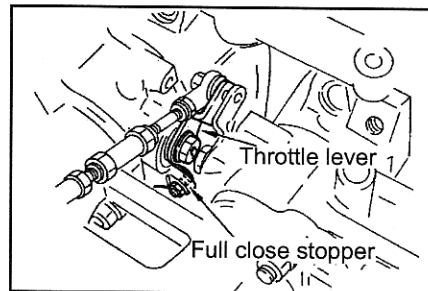

- (3) Insert 1mm feeler gauge between accelerator drum and accelerator work unit side full stopper. Fix the accelerator drum so it will not move.

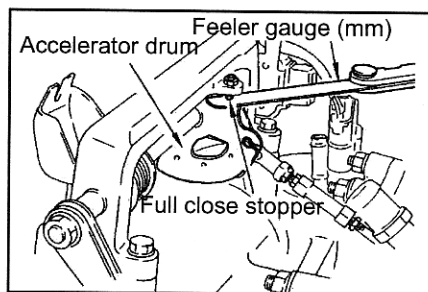

- (4) With the feeler gauge placed, turn No. 2 throttle link centre adjustment part clockwise to extend the throttle link until the full close stopper on the throttle lever and throttle chamber side contacts.

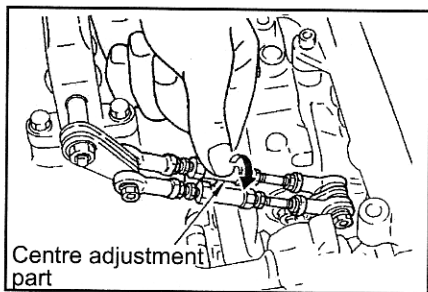

- (5) Resistance will be felt when the full close stopper hit. Extend the throttle link until just before this resistance is felt.

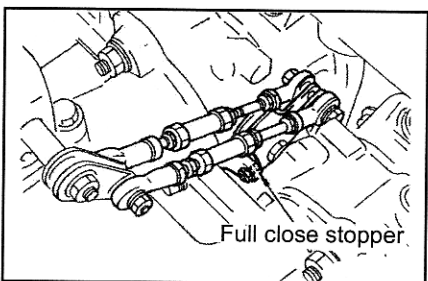

- (6) Adjust No. 3 and No. 1 throttle links as same as No. 2 throttle link adjustment.

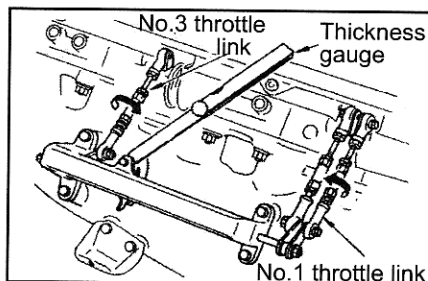

- (7) Tighten lock nut A and B after centre adjustment for 3 throttle links are completed.

Caution:

Make sure the centre adjustment parts will not turn when tightening the lock nuts.

Tightening torque(N-m{kg-m}) 2.9~3.9{0.3~0.4}

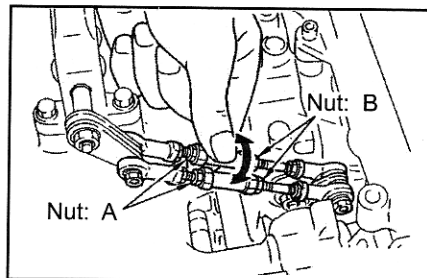

RB26DETT ENGINE

- (8) Remove the feeler gauge placed by accelerator work unit side full close stopper.

Caution:

Do not adjust the lock nut on full close stopper side.

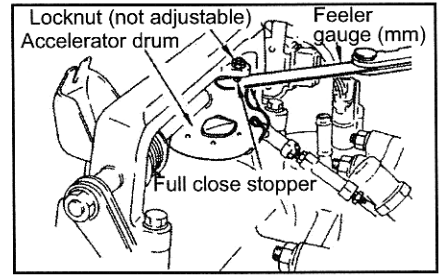

- (9) Check that each throttle chamber will move smoothly when the throttle chamber is fully closed and opened repeatedly.

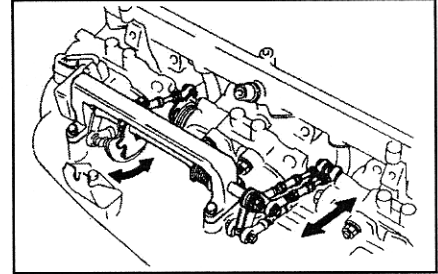

15. Install the rest in reverse order to the removal procedure.

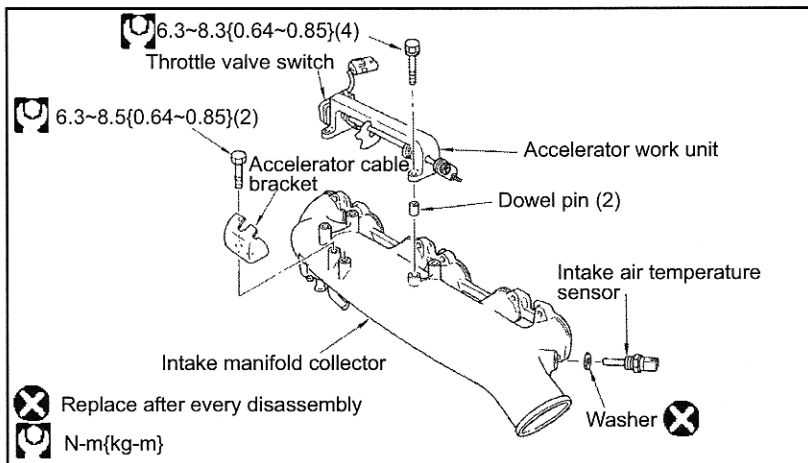

Disassembly

1. Remove the accelerator work unit.
2. Remove the intake air temperature sensor.
3. Remove the accelerator cable bracket.

Assembly

1. Install the accelerator cable bracket.
Tightening torque (N-m{kg-m}) 6.3~8.3{0.64~0.85}
2. Install the intake air temperature sensor.
 - Replace the copper washer with a new one.
Tightening torque (N-m{kg-m}) 20~29{2.0~3.0}
3. Install the accelerator work unit.
 - Install two dowel pins.
 - Tighten the installation bolts alternately.
Tightening torque (N-m{kg-m}) 6.3~8.3{0.64~0.85}

5. INTAKE MANIFOLD

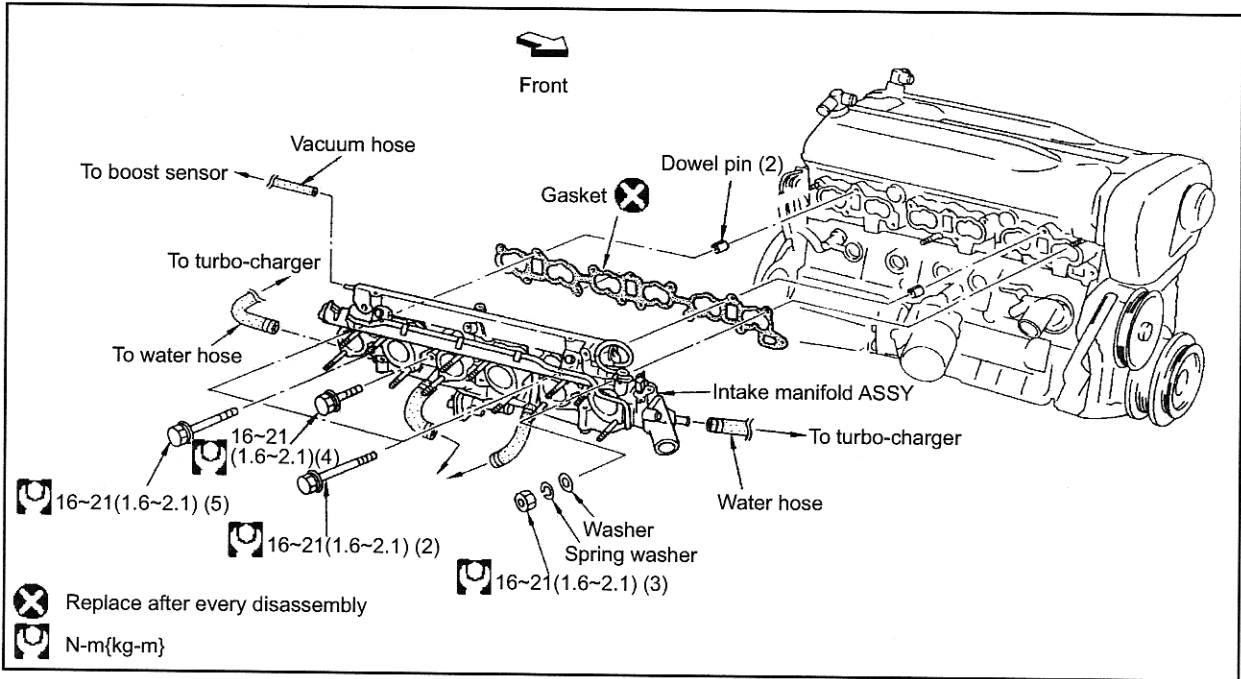

Removal

1. Release the fuel pressure.
2. Remove the battery negative terminal.
3. Drain coolant from the radiator drain plug.
4. Remove the front strut tower bar.
5. Remove accelerator cable.
6. Remove the intake manifold.
7. Remove the throttle chamber.
8. Remove the air chamber.
9. Disconnect the radiator upper hose at water outlet side.
10. Disconnect the water hose at water outlet side.
11. Remove all connectors and terminals extending from the harness cover to shift the harness cover.
12. Remove the intake manifold.
 - Loosen installation bolts and nuts in the order shown to remove intake manifold.

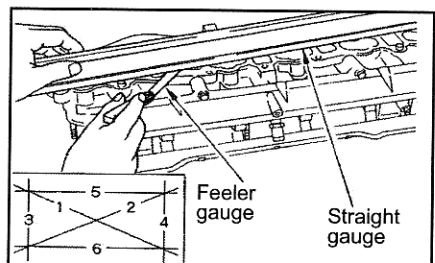
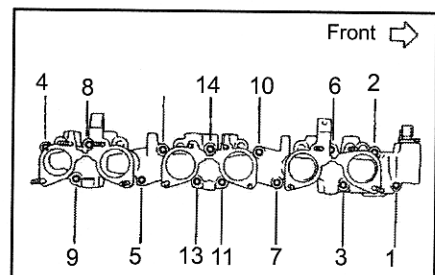
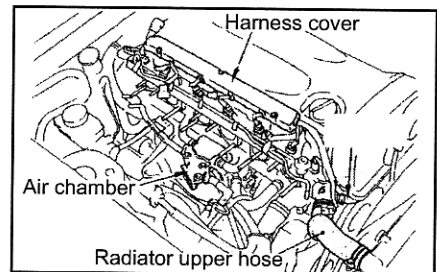

Inspection

Distortion of the intake manifold

- Use a scraper to remove old gasket.
 - Use a straight gauge and feeler gauge to measure the distortion of the front and reverse surface in six directions.
- Limit value (mm) 0.15
- Replace the intake manifold if the distortion is over the limit.

RB26DETT ENGINE

Installation

1. Install the intake manifold.
 - (1) Remove old gasket from the intake manifold and the cylinder head and clean the surface using the white gasoline.
 - Also clean the intake manifold on the throttle chamber side.
 - (2) Install the gasket.
 - Replace the gasket with a new one.
 - (3) Install the intake manifold.
 - Depending on the installation position, the bolt under head length will differ.
- Installation bolt (underhead: 30mm) 3, 5, 6, 8
 (underhead: 60mm) 1, 4, 10, 12, 14
 (underhead: 65mm) 7, 9
- Installation nut 2, 11, 13
- Tighten installation bolts and nuts in order shown in the figure on right in several stages.
- Tightening torque (N-m{kg-m}) 16~21{1.2~2.1}

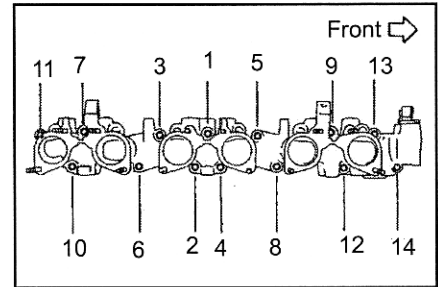

2. Install the rest in reverse order to the removal procedure.

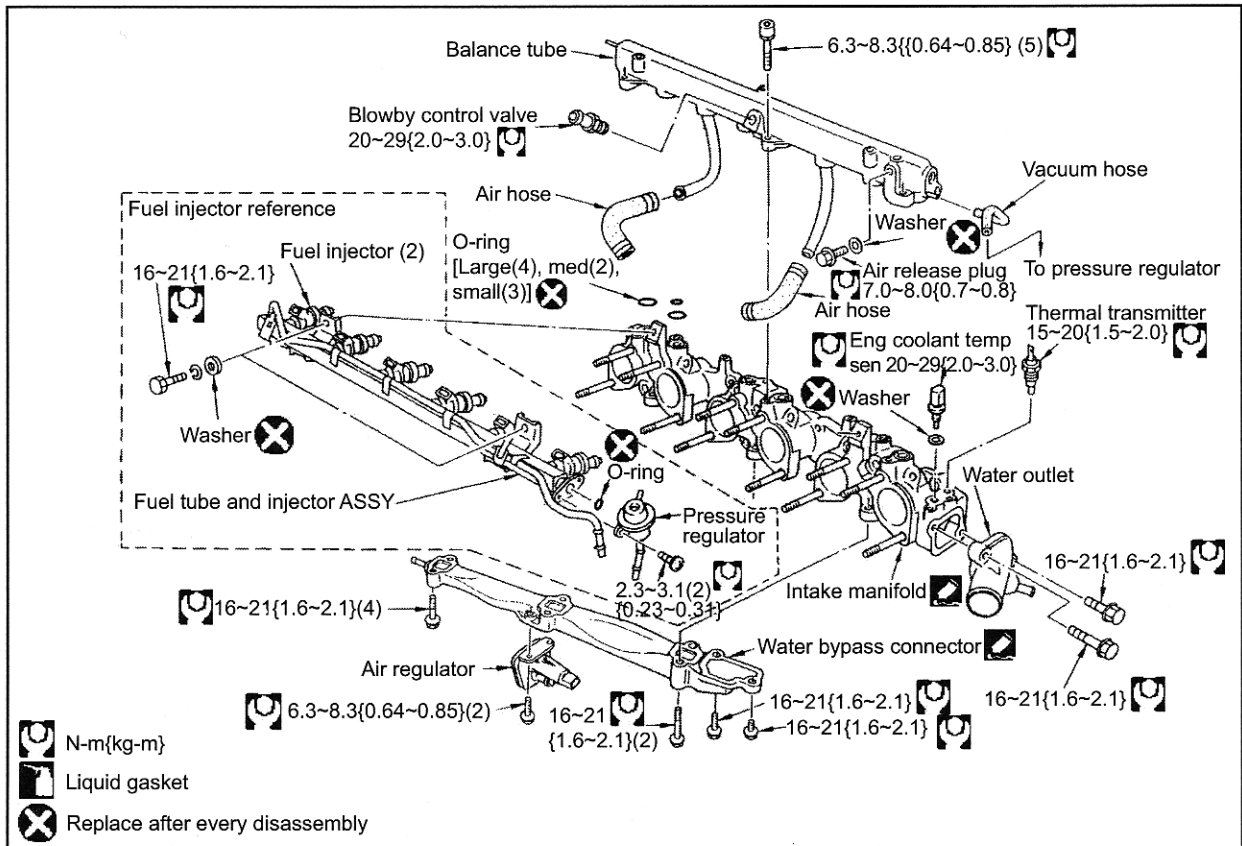

Disassembly

1. Remove the fuel tube and injector ASSY.
2. Remove the air regulator.

RB26DETT ENGINE

3. Remove the water bypass connector.
 - Insert a tool such as a screwdriver between the intake manifold and the water bypass connector and move it lightly to remove the connector.

Caution:

Care must be taken not to damage the installation surface.

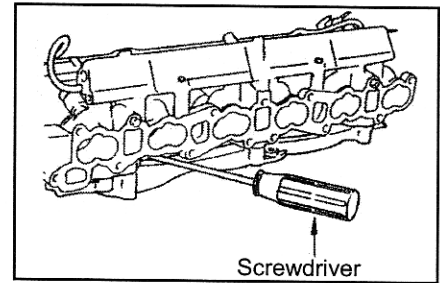

4. Remove the water outlet.
 - Insert a screwdriver handle into the water outlet as shown and move it lightly to remove.

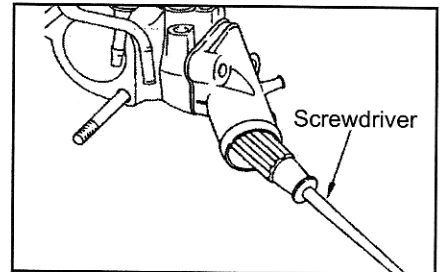

5. Remove the balance tube.
 - Check the o-ring size while removing.

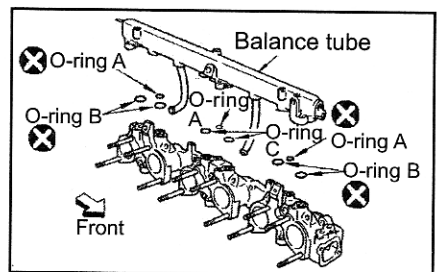

Assembly

1. Use the method below to caulk the clamp if the air hose was removed from the balance tube.

- (1) Make end of the end nipper as shown in the diagram. The end nipper can be purchased commercially.
 - Caulk the clamp using the end nipper.

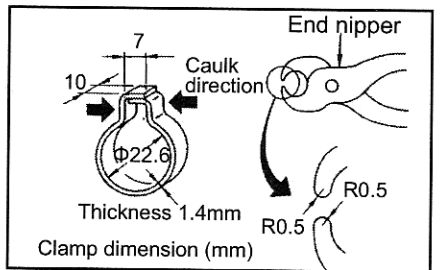

- (2) Install the clamp in a way so the caulk position is as shown in the diagram.

Caution:

If the non-genuine clamp is used or caulk position is installed incorrectly, the throttle valve may not close correctly due to throttle lever interference.

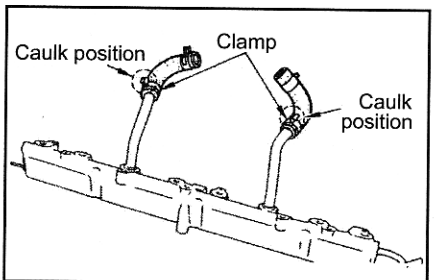

2. Install the balance tube.
 - Replace the o-ring with a new one.
 - There are three types of o-ring. Make sure to install correct o-rings.
 - A (small): 3 positions near cylinder head
 - B (med): 2 centre positions near throttle chamber
 - C (large): 4 outer positions near throttle chamber
 - Install the o-ring to installation groove.
- Tightening torque (N-m{kg-m}) 6.3~8.3{0.64~0.85}

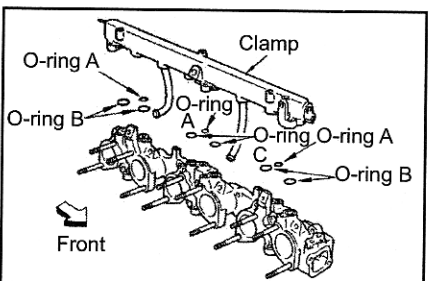

RB26DETT ENGINE

3. Install the water outlet.

- (1) Remove old gasket from the intake manifold and the water outlet and clean the surface using the white gasoline.
- (2) Apply sealing agent (KP710 00150) to position shown with no gaps at approx. $\Phi 2.0\sim 3.0\text{mm}$.
Tightening torque (N-m{kg-m}) 16~21{1.6~2.1}

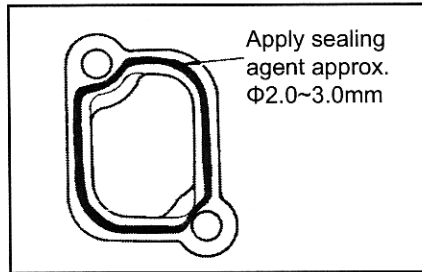

4. Install the water bypass connector.

- (1) Remove old gasket from the intake manifold and the water bypass connector and clean the surface using the white gasoline.
- (2) Apply sealing agent (KP710 00150) to position shown with no gaps at approx. $\Phi 2.0\sim 3.0\text{mm}$.

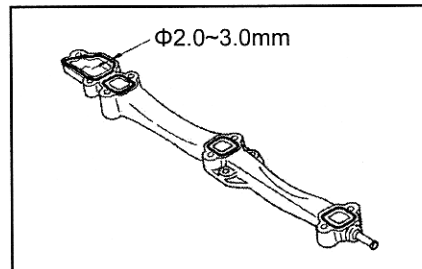

- (3) Tighten installation bolts from the centre to outside.
 - Depending on the installation position the bolt head length will differ.
- Tightening torque (N-m{kg-m}) 16~21{1.6~2.1}

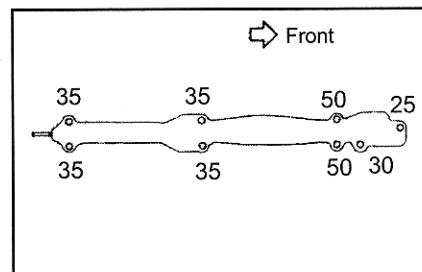

- 5. Install the air regulator.
Tightening torque (N-m{kg-m}) 6.3~8.3{0.64~0.85}
- 6. Install the engine coolant temperature sensor.
 - Replace the copper washer with a new one.
 - Apply sealing agent to the thread part.
 Tightening torque (N-m{kg-m}) 20~29{2.0~3.0}
- 7. Install the fuel line and injector ASSY.

Removal

1. Remove the battery negative terminal inside the boot.
2. Remove the front spoiler under cover (N1 vehicle).
3. Remove the under cover.
4. Remove the exhaust front tube.
5. Drain coolant from the radiator drain plug.
6. Drain coolant from the cylinder drain plug.
7. Remove the front strut tower bar.
8. Remove the air duct, air cleaner case and the air hose.

Caution:

Close the turbo-charger opening to avoid foreign objects from entering.

9. Remove the exhaust gas sensor.
 - Use exhaust gas sensor removal socket to remove.
 - Do not drop or cause damage to the sensor.

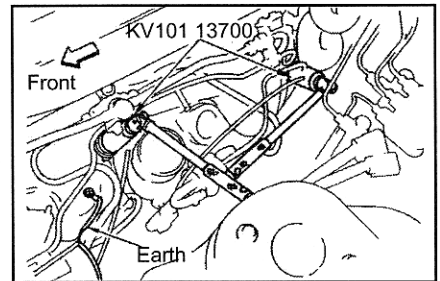

10. Disconnect all tubes and hoses shown in the figure on right.

- (1) Disconnect the exhaust gas sensor connector and remove the harness connector from the bracket.
- (2) Remove the air hose from the bracket.
- (3) Place alignment mark as necessary and remove the rear turb-charger outlet tube, 2 air hoses, front turbo-charger outlet tube and the air tube.

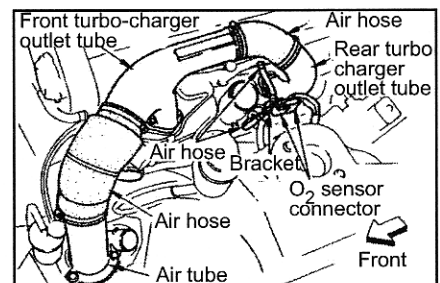
**Caution:**

Close the turbo-charger opening to avoid foreign objects from entering.

11. Remove the water return tube (A).

- Remove in the order of 1 to 4.

12. Remove the air tube.

- Remove in the order of 5 to 7.

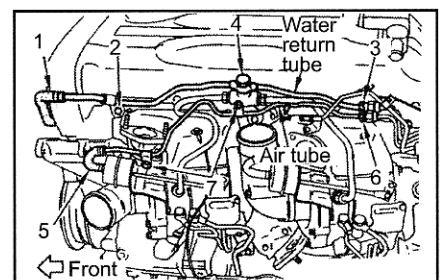

13. Remove the water return tube (B) and (C).

- (1) Loosen the nut (8) and (9).
 - (2) Loosen nut (10) and remove the water return tube (B).
 - (3) Loosen nut (11) and remove water return tube (C).
14. Remove the water connector.
15. Remove the exhaust manifold cover.

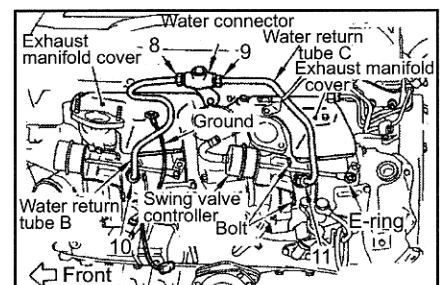

RB26DETT ENGINE

16. Remove water feed tube eye bolt and oil feed tube eye bolt.
17. Remove the oil feed tube installation bolt.
18. Remove the oil return hose and the oil return tube.
19. Remove the turbo-charger support.

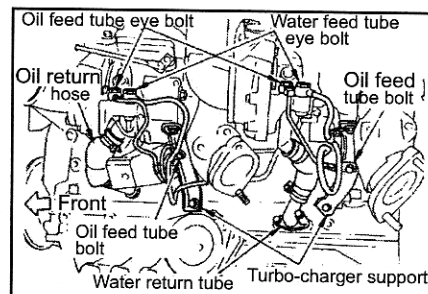

20. Remove the turbo-charger ASSY from the exhaust manifold.
- (1) Open the lock plate claw and loosen the turbo-charger ASSY installation nuts.

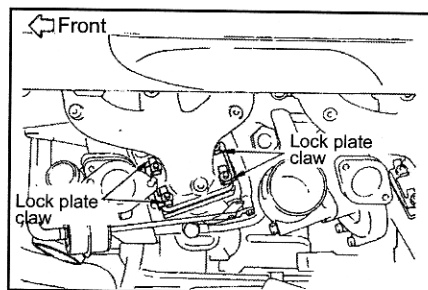

- (2) Remove the turbo-charger ASSY from the exhaust manifold and place it below the exhaust manifold.

Caution:

Do not bend the oil tube and water tube.

21. Remove the turbo-charger gasket.

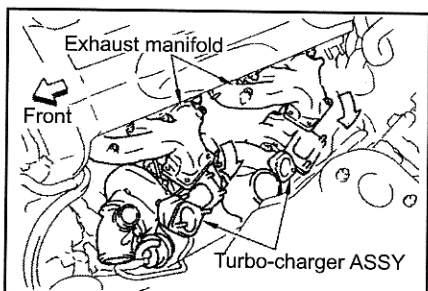

22. Remove exhaust manifold.

- Remove installation bolts in the order shown.

23. Remove the exhaust manifold gasket.

24. Remove the turbo-charger ASSY.

Caution:

Care must be taken not to bend the oil tube and the water tube.

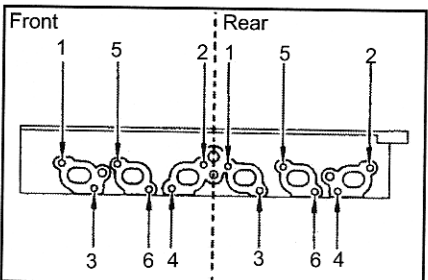

25. Remove the water feed tube and the oil feed tube from the cylinder block.

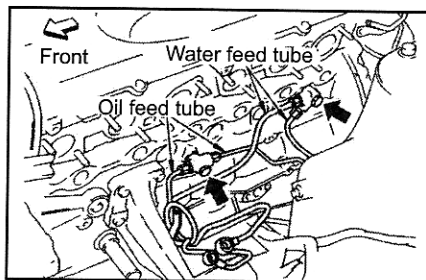

26. Remove the air tube and the water return tube ASSY from the cylinder head rear side.

- Remove the installation bolts and the cylinder head auxiliary bolts.

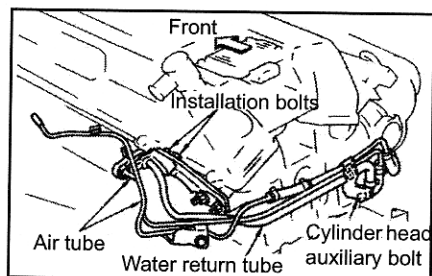

Inspection

Distortion of exhaust manifold

- Use a scraper to remove gasket on the installation surface.
- Use a straight gauge and feeler gauge to measure the installation surface distortion in four directions.
Limit value (mm) 0.3
- Replace the exhaust manifold if the distortion is over the limit.

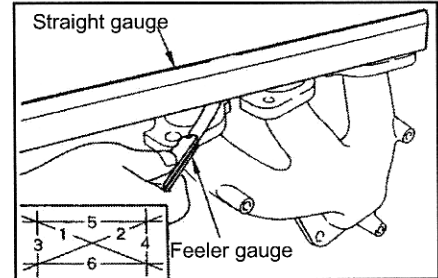

Gas leak from the exhaust parts

- Look for any gas leak from the cylinder head installation surface, catalytic converter installation surface and the exhaust front tube installation surface.

Installation

- Each pipe installation location is shown in the figure below.

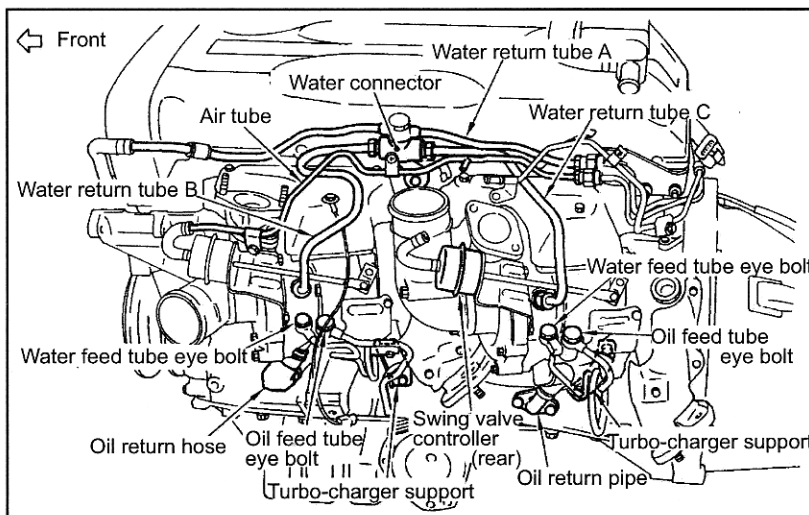

1. Install the air tube / water return tube ASSY to the cylinder head rear side.

Tightening torque (N-m{kg-m})

Cylinder head auxiliary bolt 9.0~12{0.92~1.2}

Installation bolt 6.3~8.3{0.64~0.85}

2. Install the water feed tube and the oil feed tube to the cylinder block.

- Replace the copper washer with a new one.
- Install the eye bolt with ID mark 'M' to the oil feed tube.

Tightening torque (N-m{kg-m})

Water feed tube eye bolt 20~31{2.0~3.2}

Oil feed tube eye bolt 15~20{1.5~2.0}

3. Lower the turbo-charger ASSY to the left side of the engine making sure each tube is not bent.

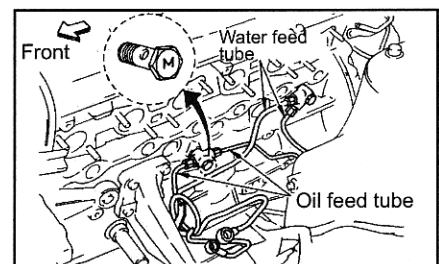
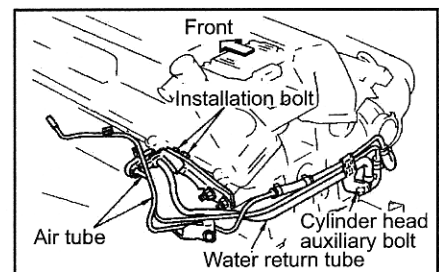

RB26DETT ENGINE

4. Install the stud bolt to the cylinder head by inserting the double nut.
- When installing the stud bolt, make sure the stud bolt with the shorter thread side is installed to the cylinder head side.

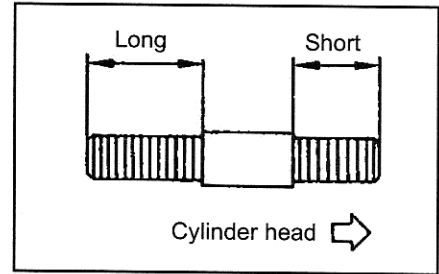

5. Install the exhaust manifold gasket.
- Replace the gasket with a new one.
 - Remove old gasket from the cylinder head and the exhaust manifold and clean the surface using the white gasoline.

6. Install the exhaust manifold.

- (1) Install the washer with the flat surface facing the cylinder head.

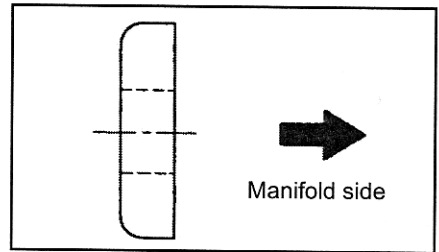

- (2) Tighten the installation nuts in the order shown in the figure.

Tightening torque (N-m{kg-m}) 18~24{1.8~2.4}

- Replace the installation nuts with new ones.

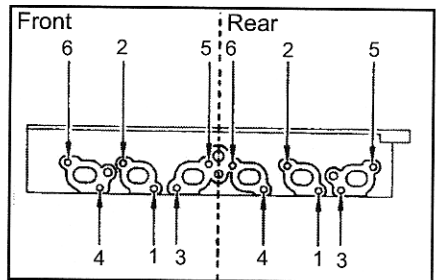

7. Install the turbo-charger ASSY to the exhaust manifold.

- Replace the gasket with a new one.
- After tightening the installation nuts fold the lock plate claw inwards.
- Replace the lock plate with a new one.

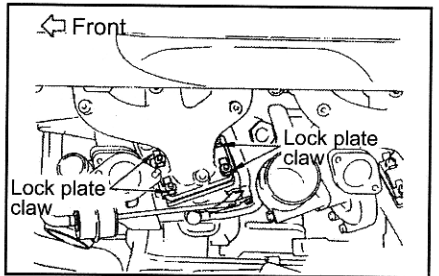

8. Install the turbo-charger support.

Tightening torque (N-m{kg-m}) 16~21{1.6~2.1}

9. Install the oil feed tube installation bolt to the turbo-charger support.

Tightening torque (N-m{kg-m}) 6.3~8.3{0.64~0.85}

10. Install the oil return hose and the oil return tube.

Tightening torque (N-m{kg-m}) 16~21{1.6~2.1}

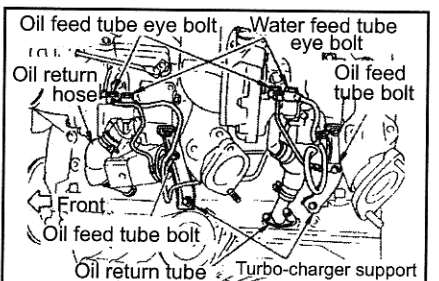

11. Install the water feed tube eye bolt and the oil feed tube eye bolt.

- Replace the copper washer with a new one.

Tightening torque (N-m{kg-m})

Water tube eye bolt 29~39{3.0~4.0}

Oil tube eye bolt 18~20{1.8~2.0}

RB26DETT ENGINE

12. Install the exhaust manifold cover.

- Attach earth wire to the front side exhaust manifold cover.

Tightening torque (N-m{kg-m}) 3.7~5.0{0.38~0.51}

13. Install the water connector.

Tightening torque (N-m{kg-m}) 31~44{3.1~4.4}

14. Install the water return tube (B) and (C).

- First temporarily tighten the nuts 8 to 11, then fully tighten.

Tightening torque (N-m{kg-m}) 20~31{2.0~3.2}

15. Install the air tube.

- Install the nuts in the order of 7 to 5.

Tightening torque (N-m{kg-m})

Nut 7 6.3~8.3{0.64~0.85}

Installation bolt 6 15~20{1.5~2.0}

16. Install the water tube (A).

- Install in the order of 4 to 1.

- Install an eye bolt with identification mark 'N' for No. 4 eye bolt.

Tightening torque (N-m{kg-m})

Eye bolt No. 4 33~41{3.4~4.2}

Eye bolt No. 3 21~31{2.0~3.2}

Installation bolt No. 2 6.3~8.3{0.64~0.85}

17. Install every tube and hose shown in the figure.

- (1) Install the rear turbo-charger outlet tube, two air hoses, the front turbo-charger outlet tube and the air tube by aligning to the alignment mark.

- (2) Install the bracket to the rear turbo-charger outlet tube.

Tightening torque (N-m{kg-m}) 6.3~8.3{0.64~0.85}

- (3) Install the air hose to the bracket.

- (4) Connect the O₂ sensor connector and fix to the bracket.

18. Install the rest in reverse order to the removal procedure.

19. Install the O₂ sensor.

- Use the exhaust gas sensor installation socket to install.

- Care must be taken not to cause any damage.

- Do not drop or hit the sensor.

Tightening torque (N-m{kg-m}) 40~50{4.1~5.1}

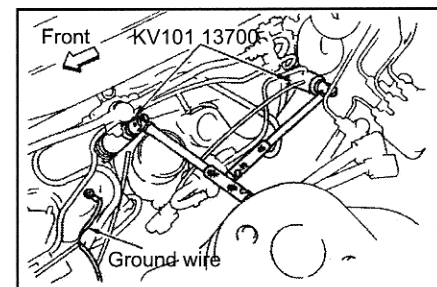
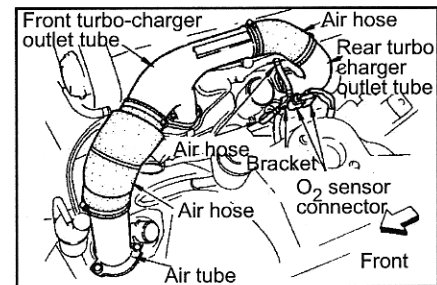
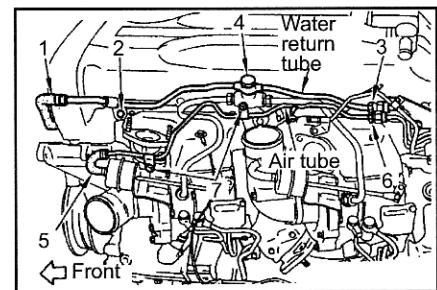
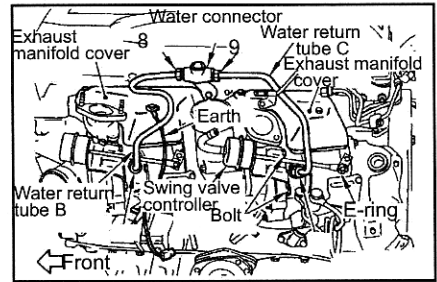

Inspection

Start the engine and make sure there are no coolant or engine oil leaks from the turbo-charger connections. Also check the exhaust manifold and the turbo-charger connection for any exhaust gas leak.

RB26DETT ENGINE

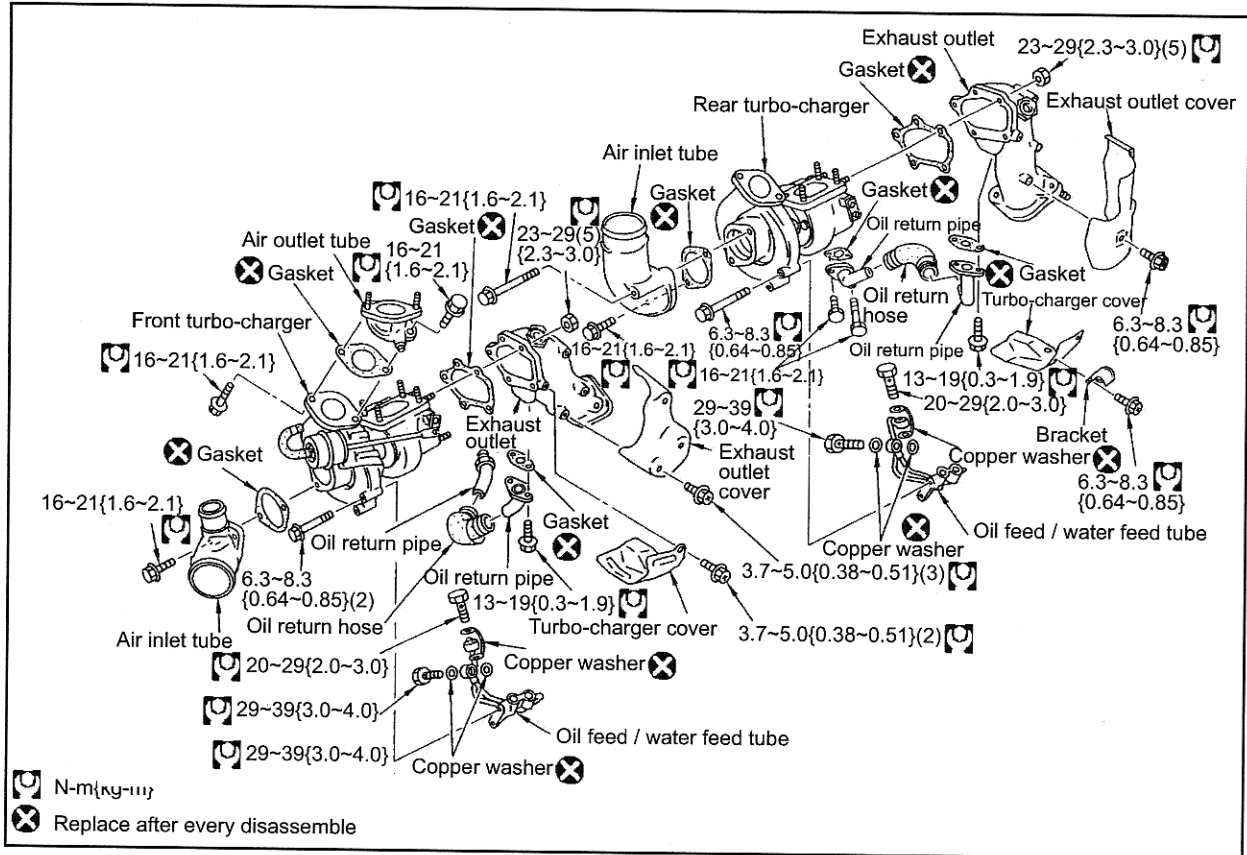
**Disassembly****Turbo-charger****Caution:**

Do not disassemble turbo-charger main body.

1. Remove the exhaust outlet cover and the turbo-charger cover.
2. Remove the exhaust outlet.
3. Remove the air inlet tube.
4. Remove the air outlet tube (front turbo-charger only).
5. Remove the oil feed and water feed tube.
6. Remove the oil return pipe and the oil return hose.

RB26DETT ENGINE

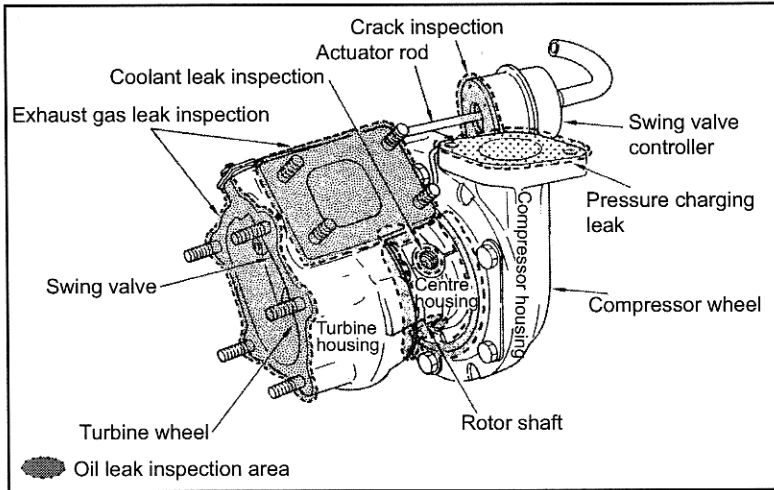

Water feed / Return tube

- Check to make sure there are no blockages or rust inside the water feed and the return tube by blowing compressed air using a air gun after cleaning the tube with radiator cleaner.

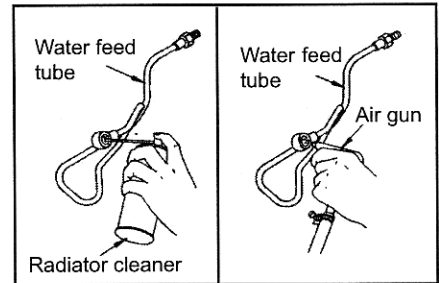

Oil feed / Return tube

- Check to make sure there are no blockage or rust inside the oil feed and the return tube by blowing compressed air using a air gun after cleaning the tube with engine conditioner.

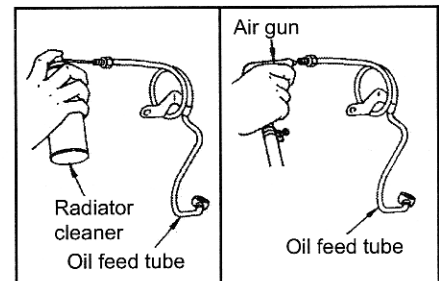

Turbo-charger

- Clean before inspection.
- Clean the oil feed and the oil return with engine conditioner.
- Clean the water feed and return with radiator cleaner.
- Blow compressed air using a air gun to the compressor wheel, turbine wheel, compressor housing and turbine housing.

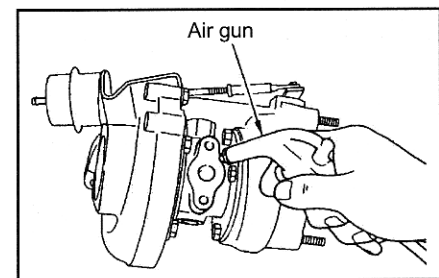
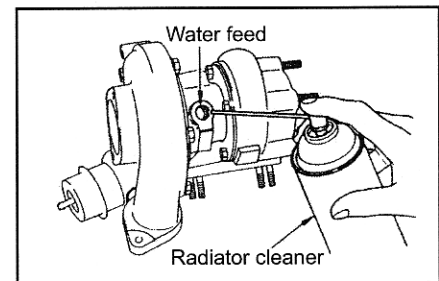

RB26DETT ENGINE

Rotor shaft

- Make sure the rotor shaft will turn smoothly when pushed with finger.
- The rotor shaft must not be loose when moved right / left.

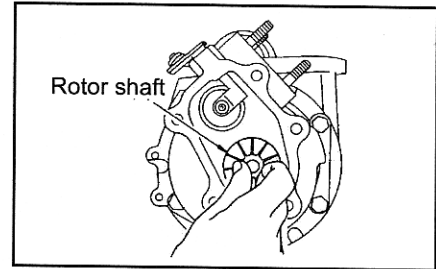

- Make sure there are no carbon sludge accumulation.
- Make sure there are no change in colour with the rotor shaft.

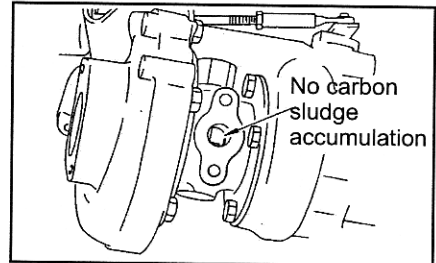

Rotor shaft end play

- Set end play by placing the dial gauge to the rotor shaft end and place it to the axle direction.

Standard value (mm) 0.013 ~ 0.097

Reference:

Rotor shaft diameter direction

Clearance standard value (mm): 0.056 ~ 0.127

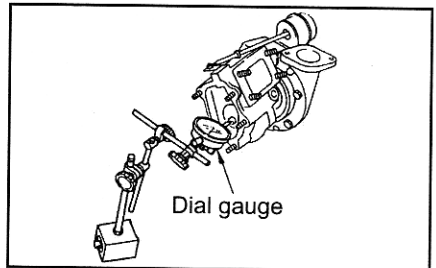

Turbine wheel

- Make sure there are no grease adhesion.
- Make sure there are no carbon accumulation.
- Make sure the turbine wheel blade is not bent or broken.
- Make sure there are no interference between the turbine housing and the wheel.

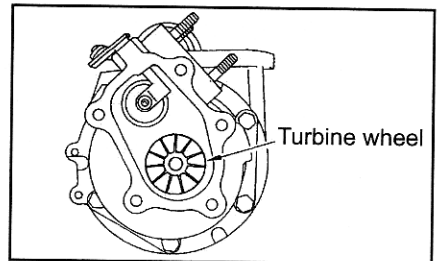

Swing valve

- Remove actuator rod E-ring and check if the swing valve will move smoothly with no deformation or damage.
- Check for any abnormality with the turbine housing seat surface.

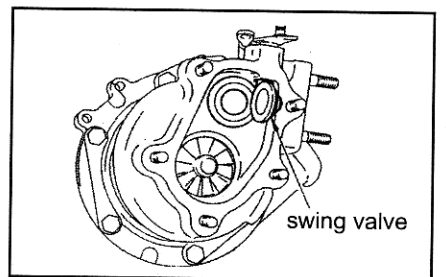

Compressor wheel

- Make sure there are no grease adhesion at admission port.
- Check for any interference between the compressor housing.
- Make sure the wheel is not bent or damaged.

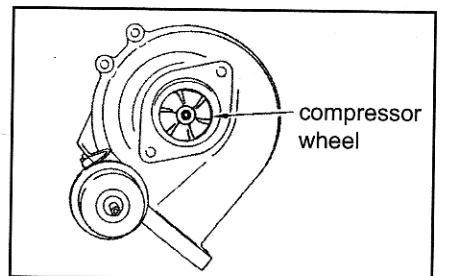

RB26DETT ENGINE

Swing valve controller

- Remove swing valve controller rubber hose on the compressor housing side.
- Inspection must be carried out when actuator rod is installed and removed.
- Make sure the swing valve controller rod will operate when the air gun is used to blow compressed air. Stop the air gun operation as soon as it starts moving.

Actuator rod operation pressure (kPa{mmHg})

0.38mm lift	59~64{440~480}
4.00mm lift	78~84{587~627}

Caution:

Before blowing the air into the swing valve controller rod make sure to check the air gun pressure using the LPG pressure gauge (0.10MPa{1kg/cm²} ST1957 2000) so it will not damage the diaphragm.

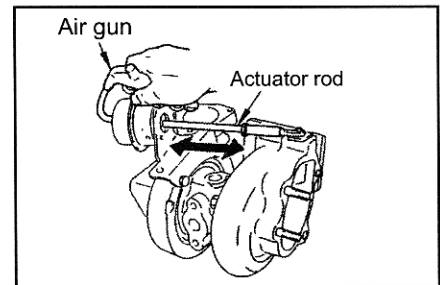
**Assembly**

1. Install the oil return pipe and the oil return hose.
Tightening torque (N-m{kg-m}) 13~19{1.3~1.9}
2. Install the oil feed and water feed tube.
 - Replace the copper washer with a new one.
 - Tighten using the method below:
 - (1) Temporarily tighten two bolts (A).
 - (2) Tighten oil feed tube eye bolt B and the water feed tube eye bolt C.
Tightening torque (N-m{kg-m})

Eye bolt (B)	20~29{2.0~3.0}
Eye bolt (C)	29~39{3.0~4.0}
 - (3) Tighten bolts (A).
Tightening torque (N-m{kg-m}) 6.3~8.3{0.64~0.85}
3. Install the air outlet tube (front turbo-charger only).
 - Replace the gasket with a new one.
Tightening torque (N-m{kg-m}) 16~21{1.6~2.1}
4. Install the air inlet tube.
 - Replace the gasket with a new one.
Tightening torque (N-m{kg-m}) 16~21{1.6~2.1}
5. Install the exhaust outlet.
 - Replace the gasket with a new one.
Tightening torque (N-m{kg-m}) 23~29{2.3~3.0}
6. Install the turbo-charger cover and exhaust outlet cover.
Tightening torque (N-m{kg-m}) 3.7~5.0{0.38~0.51}

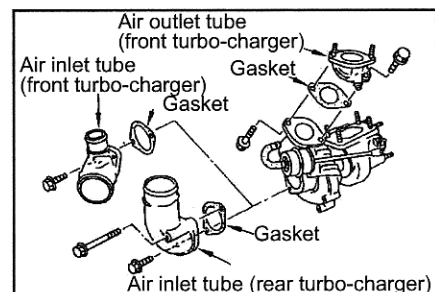
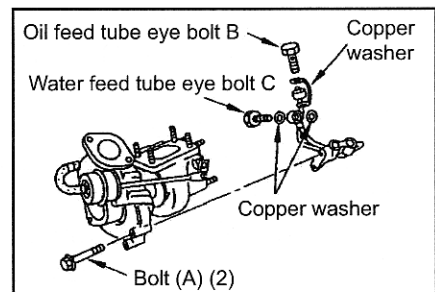

7. ROCKER COVER

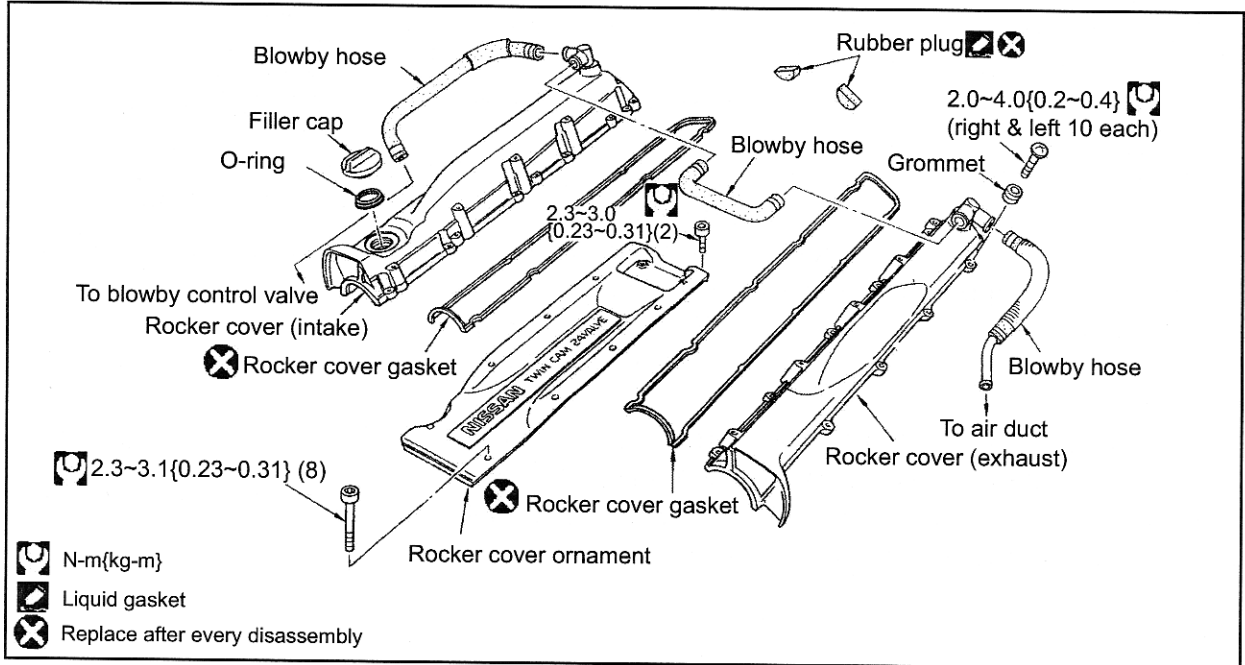

Removal

1. Remove the battery negative terminal inside the boot.
2. Remove the air duct.
3. Remove the rocker cover ornament.
4. Remove the turbo-charger outlet tube.
5. Shift the ignition coil harness.
6. Disconnect each harness and terminal and shift the harness cover.
7. Disconnect right and left blowby hose on the rocker cover side.

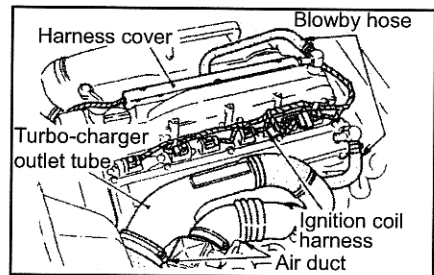

8. Remove the rocker cover.
 - Loosen the installation screws in order shown.
 - Remove both right and left rocker cover.

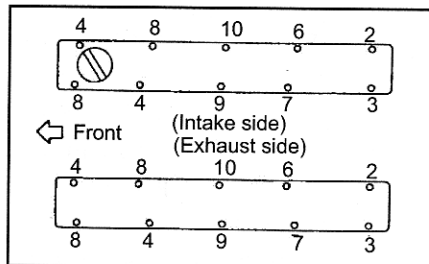

Inspection

- Check if there are any damage or cracks on the rocker cover.
- Replace the rocker cover if there is any fault.
- Check to make sure there is no oil leaking from between the rocker cover and the cylinder head.

RB26DETT ENGINE

Installation

1. Install the rubber plug to the end of the cylinder head.
 - (1) Remove old gasket from the cylinder head and the exhaust manifold and clean the surface using white gasoline.
 - (2) Apply sealing agent to the installation surface.
2. Install the gasket to the rocker cover.
 - Replace the gasket with a new one.
 3. Install the rocker cover.
 - Remove grease, dust etc. from the cylinder head side installation surface.
 - Tighten the installation screws in order shown in several stages.
Tightening torque (N-m{kg-m}) 2.0~3.9{0.2~0.4}
 4. Fix the ignition coil harness with the clamp.
 5. Install the rocker cover ornament.
 6. Install the rest in reverse order to the removal procedure.

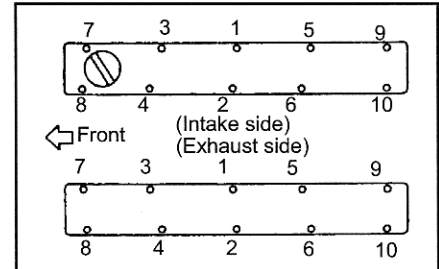
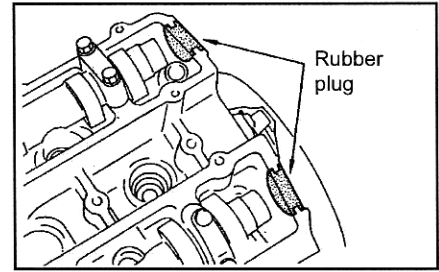

8. OIL PAN & OIL FILTER

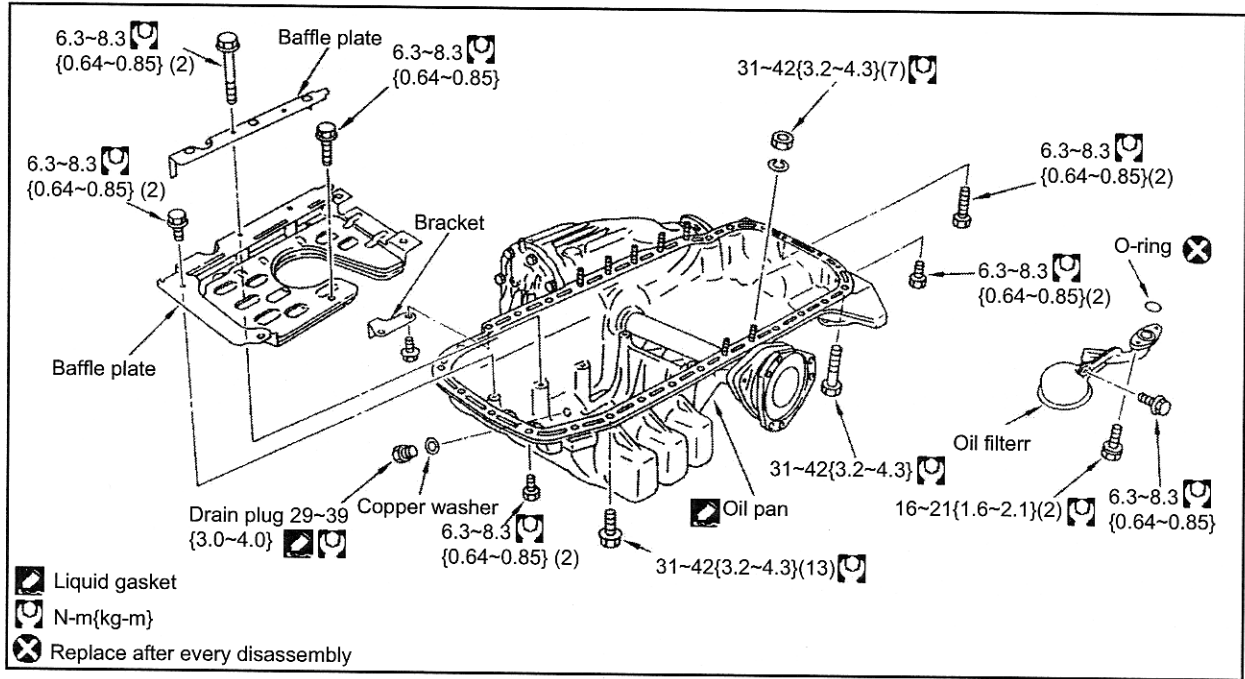

Removal

1. Remove the engine / transmission / transfer ASSY from the vehicle.
2. Remove the transmission / transfer ASSY from the engine.
3. Set the engine ASSY to the engine stand.
4. Drain the engine oil from the oil pan drain plug.
5. Remove the fly-wheel.
6. Remove the rear plate.
7. Remove the oil pan from the cylinder block.
 - (1) Remove the oil pan installation bolts and nuts in the order shown.
 - No. 12 and 16 installation bolts will tighten the bracket.
 - (2) Insert the seal cutter between the oil pan and the cylinder block.
 - (3) Tap the seal cutter rear surface using a hammer to remove the oil pan.
 - (4) Remove the oil pan carefully making sure the baffle plate will not interfere with the oil filter.
8. Remove the baffle plate.
9. Remove the oil filter.

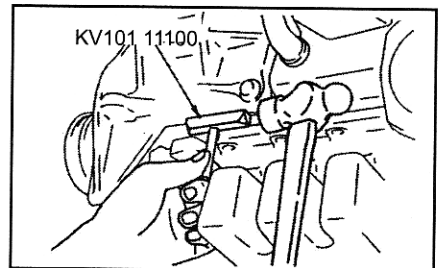
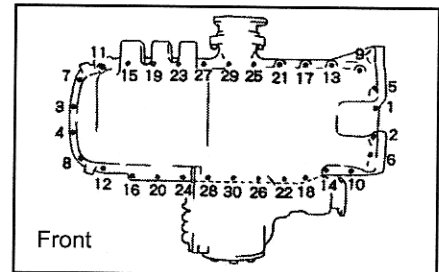

RB26DETT ENGINE

Inspection

Oil filter visual inspection

- Check that there are no foreign objects on the oil filter net.
- Clean the filter net if there are any foreign objects.
- Replace with new one if there is any fault.

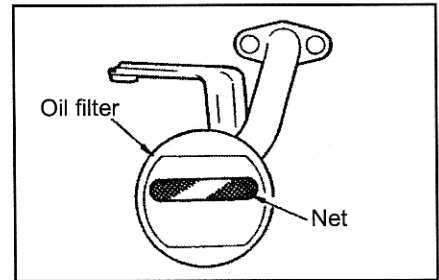

Installation

1. Install the oil filter.

- Replace the o-ring with a new one.

Tightening torque (N-m{kg-m})

M6 bolt	6.3~8.3{0.64~0.35}
M8 bolt	16~21{1.6~2.1}

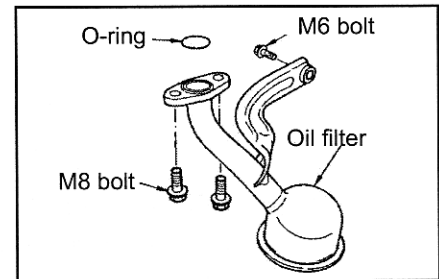

2. Install the baffle plate.

- Make sure to install the correct installation bolts.

Bolt underhead(mm)	Bolt (A)	12
	Bolt (B)	30
	Bolt (C)	55
Tightening torque (N-m{kg-m})		6.3~8.3{0.64~0.85}

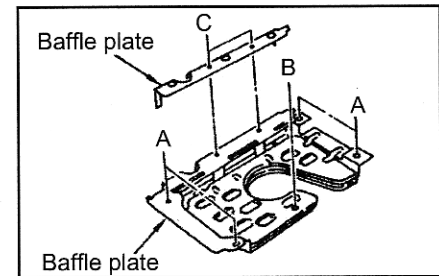

3. Install the oil pan.

- Use the scraper to remove old liquid gasket from the oil pan and the cylinder block.
- Use white gasoline to clean the installation surface.
- Apply sealing agent (KP710 00150) at $\Phi 3.5 \sim 4.5$ mm to position shown in the figure.

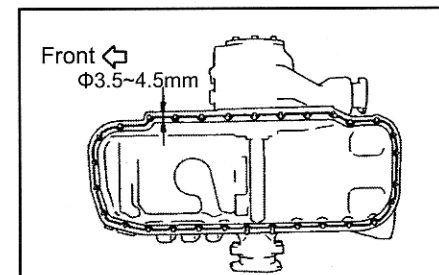

- Tighten the installation bolts in the order shown.

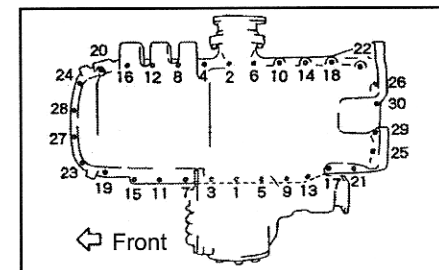

- Install the tightening bolts and the nuts.

(A)	M6 bolt (bolt underhead 16mm)
(B)	M6 bolt (bolt underhead 30mm)
(C)	M10 bolt (bolt underhead 30mm)
(D)	M10 bolt (bolt underhead 50mm)
(E)	M10 nut
Tightening torque (N-m{kg-m})	
M6 bolt	6.3~8.3{0.64~0.85}
M10 bolt & nut	31~42{3.2~4.3}

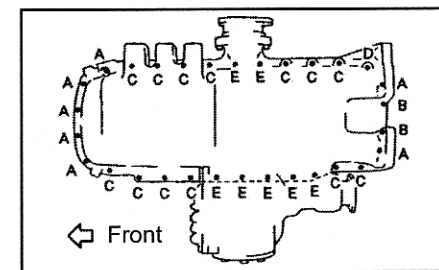

RB26DETT ENGINE

4. Install the oil pan drain plug.
 - Replace the washer with a new one.
 - Make sure the oil pan drain plug is facing in the correct direction as shown.

Tightening torque (N-m{kg-m}) 29~39{3.0~4.0}

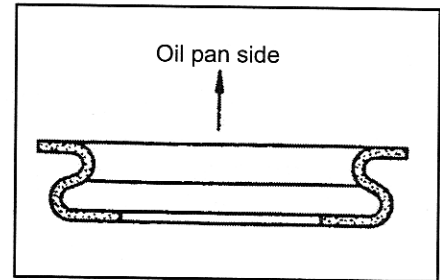

5. Install the rest in reverse order to the removal procedure.

Inspection

- Check the engine oil level.
- Warm up the engine and look for any oil leak and check the oil pressure.

RB26DETT ENGINE

9. CAM SHAFT

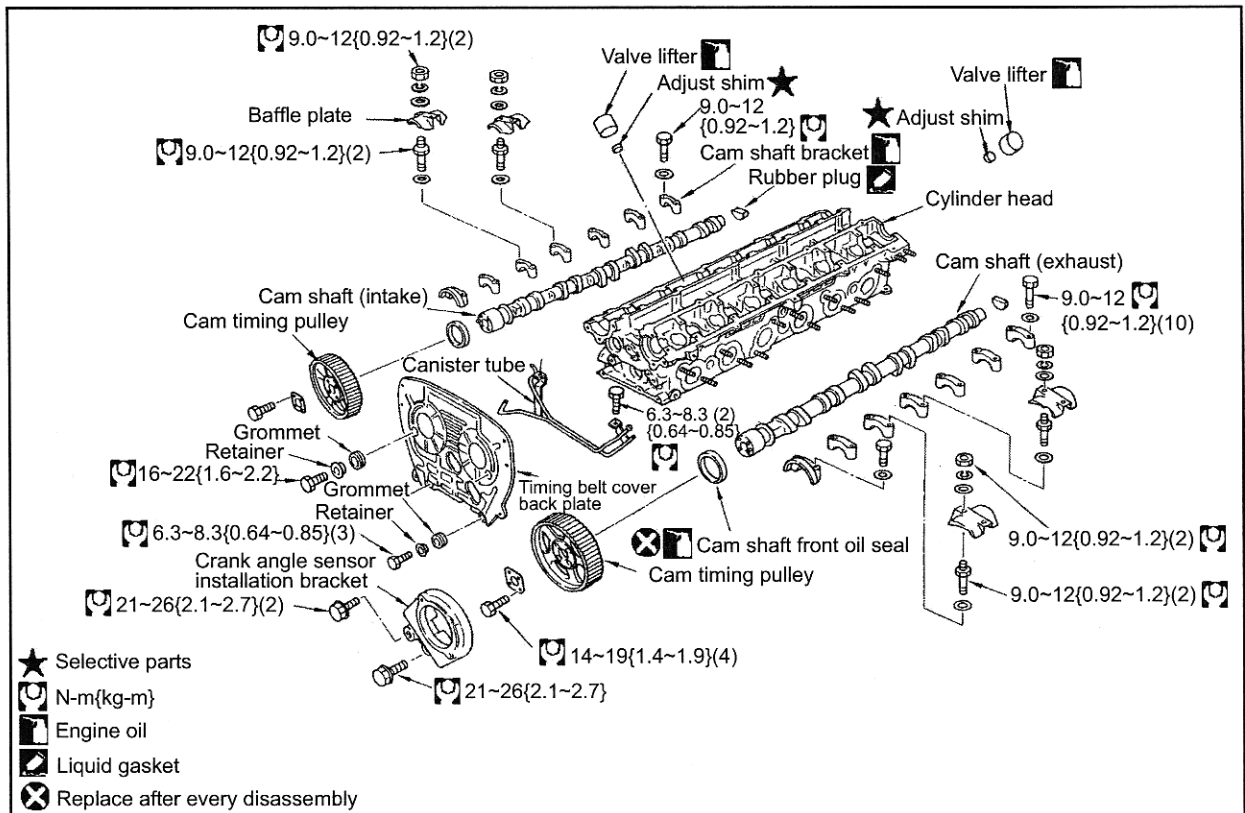

Removal

1. Remove the battery negative terminal inside the boot.
2. Remove the front spoiler under cover (N1 vehicle).
3. Remove the under cover.
4. Drain coolant from the radiator drain plug.
5. Drain coolant from the cylinder drain plug.
6. Remove the front strut tower bar.
7. Remove the front turbo-charger outlet tube, the air hose, the rear turbo-charger outlet tube (exhaust side cam shaft).
8. Remove the cooling fan.
9. Remove the radiator.
10. Remove auxiliary belt.
11. Remove the timing belt.
12. Remove the rocker cover.
13. Remove the cam timing pulley (exhaust side).
 - (1) Remove the crank angle sensor installation bracket.
 - (2) Use a spanner or the pulley holder to fix the hexagonal area of the cam timing pulley to loosen the installation bolts.
 - (3) Remove the cam timing pulley from the cam shaft.

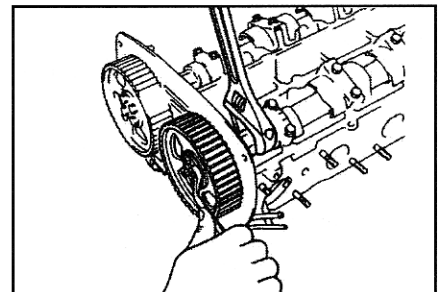

RB26DETT ENGINE

14. Remove the cam timing pulley (intake side).

- Use the spanner or the pulley holder to fix the hexagonal area of the cam timing pulley to loosen the installation bolts.

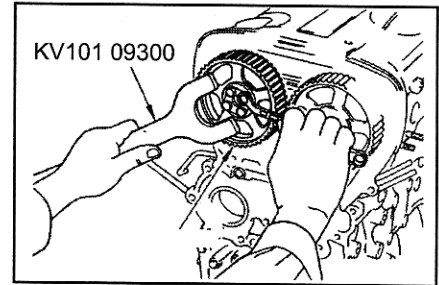

15. Remove the timing belt cover (rear) and the canister tube.

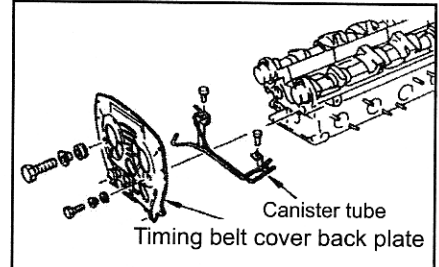

16. Remove the baffle plate from No.3 and No.4 cam shaft bracket.

17. Remove the cam bracket.

- Loosen the cam bracket installation bolts in the order shown in several stages.

Caution:

Make sure to mark the bracket installation position before removing the cam bracket.

- Carry out the cam shaft end play inspection before loosening the cam bracket installation bolts.

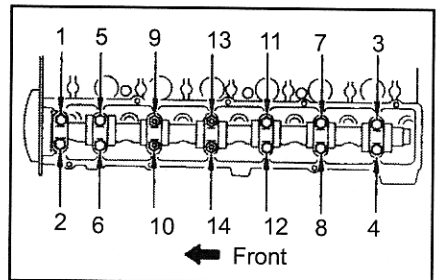

18. Remove the cam shaft.

19. Remove the cam shaft oil seal from the cam shaft.

20. Remove the valve lifter and the adjustment shim.

- Check the installation position and store it to avoid confusion.

Inspection

Cam shaft visual inspection

- Check to make sure there is no damage or wear to the cam shaft.
- Replace if any abnormalities are found.

Cam shaft run-out

- Use V-block on a fixed surface and support cam shaft No. 1 and No. 7 journal.
- Set dial gauge vertically to No. 4 journal.
- Rotate the cam shaft in one direction and read the movement width on the dial gauge.

Standard value (mm) 0.02

Limit value (mm) 0.05

- If the run-out is over the limit value replace the cam shaft.

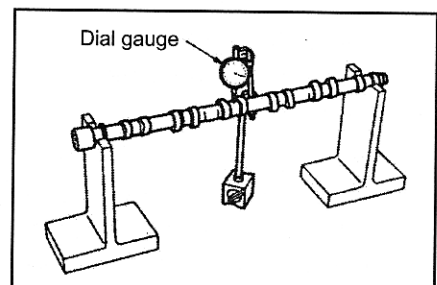

RB26DETT ENGINE

Cam nose height

- Use micrometer to measure cam nose height.

Standard value (mm)

Intake 40.58

Exhaust 40.28

Wear out limit value (mm)

Intake 0.05

Exhaust 0.05

- If the value is over the limit replace the cam shaft.

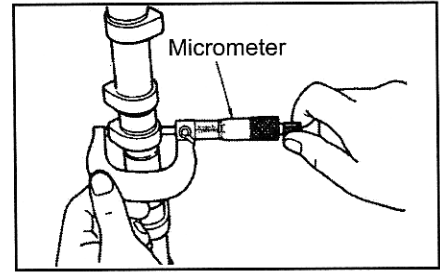

Cam shaft oil clearance

(Cam journal external diameter)

- Use micrometer to measure cam journal external diameter.

Standard value (mm) $\Phi 27.935 \sim \Phi 27.955$

(Cam bracket internal diameter)

- Tighten cam bracket bolt to specified torque.

- Use inside micrometer to measure.

Standard value (mm) $\Phi 28.000 \sim \Phi 28.021$

(Cam shaft oil clearance) =

(Cam bracket internal diameter) -

(Cam journal external diameter)

Standard value (mm) $\Phi 0.045 \sim \Phi 0.086$

- If the value is not within standard value, replace cylinder head ASSY or cam shaft.

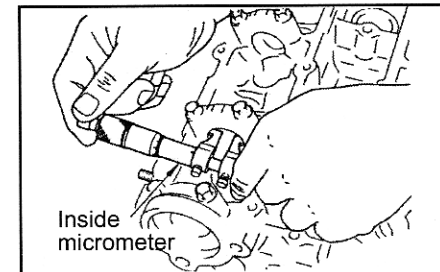
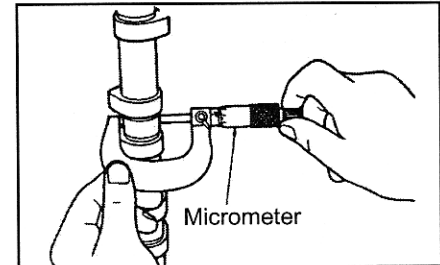

Cam shaft end play

- Set a dial gauge to the front end of the cam shaft in thrust direction. Move the cam shaft forwards and backwards and read the dial gauge run-out measurement.

Standard value (mm) 0.060~0.110

- If the value is not within standard value, replace the cam shaft. Re-measure and if the value is still not at standard value, also replace the cylinder head.

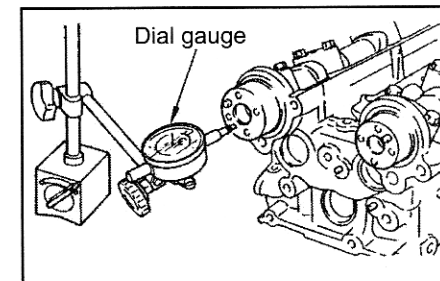

Valve lifter clearance

(Valve lifter external diameter)

- Use micrometer to measure hydraulic valve lifter external diameter.

Standard value (mm) $\Phi 30.955 \sim 30.965$

(Valve lifter internal diameter)

- Use inside micrometer to measure hydraulic valve lifter internal diameter.

Standard value (mm) $\Phi 31.000 \sim 31.020$

(Valve lifter clearance) =

(Hydraulic valve lifter internal diameter) -

(Hydraulic valve lifter external diameter)

Standard value (mm) $\Phi 0.035 \sim 0.065$

- If the value is not within standard value, replace hydraulic valve lifter or cylinder head.

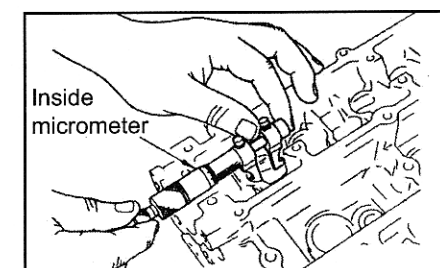
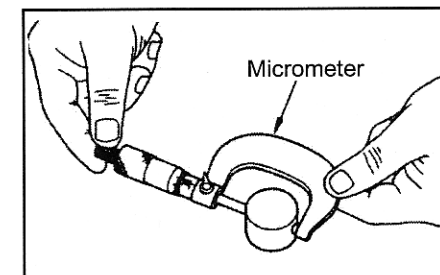

Valve lifter visual inspection

- Check the cam nose rotational area and the lifter surface for any damage or wear. Replace if there are any abnormality.

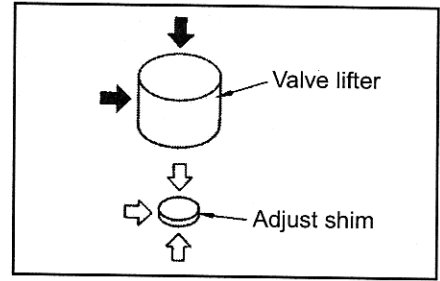

Adjustment shim visual inspection

- Look for any damage or wear on the valve stem contact surface. Replace if there are any abnormalities.

Installation

1. Install the valve lifter and the adjustment shim.
 - Apply engine oil to the rotational area.
 - Install it in the correct position.
2. Install the cam shaft to the cylinder head.
 - Apply engine oil to the cam nose, journal and thrust parts.
 - The distinction between the intake and the exhaust side cam shaft can be determined by the crank angle sensor drive spline.

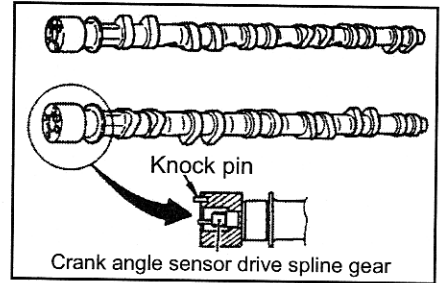

3. Install the cam shaft to the cylinder head so the knock pin is as shown in the figure.

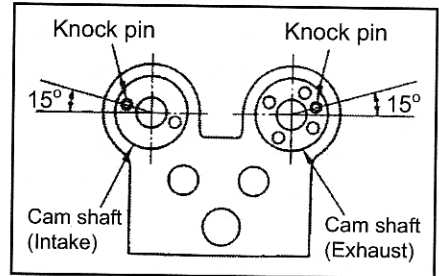

4. Install the cam bracket.

- (1) Check the engraved mark on the cam bracket surface and the markings you have made at the removal to install the cam bracket in correct position.

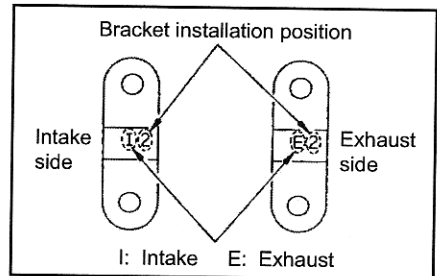

- 2) Tighten the cam bracket installation bolts in the order shown in several stages.

Tightening torque (N-m{kg-m}) 9.0~12{0.92~1.2}

5. Install the baffle plate to No.3 and No.4 cam shaft bracket.

Tightening torque(N-m{kg-m}) 9.0~12{0.92~1.2}

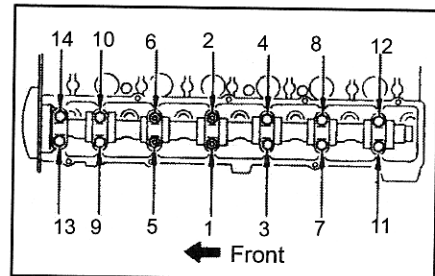

6. Install the timing belt cover (rear).

Tightening torque (N-m{kg-m})

M6 bolt

6.3~8.3{0.64~0.85}

M8 bolt

16~22{1.6~2.2}

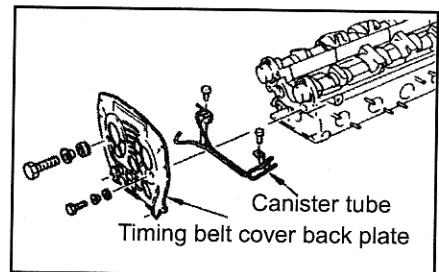

RB26DETT ENGINE

7. Install the cam front oil seal.
8. Install the cam timing pulley (intake).
 - (1) Install the cam timing pulley to the cam shaft.
 - Face the washer with the chamfered side towards the pulley.
 - (2) Apply engine oil to thread parts and the bearing surface of the installation bolts.
 - (3) Use the spanner to fix cam shaft hexagonal part to tighten installation bolt.

Tightening torque (N-m{kg-m})	14~19{1.4~1.9}
-------------------------------	----------------

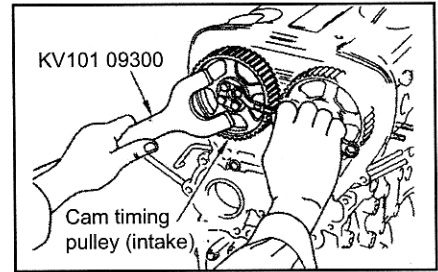

9. Install cam timing pulley (exhaust).
 - (1) Install cam timing pulley to the cam shaft.
 - Fix cam shaft hexagonal part using the spanner or pulley holder to fix the timing pulley to tighten installation bolts in opposite angle.

Tightening torque (N-m{kg-m})	14~19{1.4~1.9}
-------------------------------	----------------
 - (2) Install crank angle sensor installation bracket.

Tightening torque (N-m{kg-m})	21~26{2.1~2.6}
-------------------------------	----------------

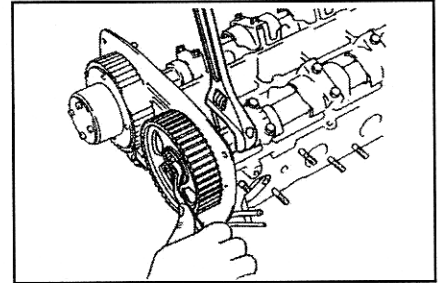

10. Install the rest in reverse order to the removal procedure.

10. VALVE CLEARANCE

Inspection

- Measure the valve clearance when the cam shaft and the valve associated parts are removed or replaced. If the value is out of standard value replace the adjustment shim.

Valve clearance standard value (mm)

(When cold)	Intake	0.42~0.48
	Exhaust	0.35~0.41
(When hot: reference only)	Intake	0.48~0.54
	Exhaust	0.41~0.47

Removal

1. Remove the battery negative terminal inside the boot.
2. Remove the under plate.
3. Remove the under cover.
4. Drain coolant from the radiator drain plug.
5. Drain coolant from the cylinder drain plug.
6. Remove the front turbo-charger outlet tube, the air hose, the rear turbo-charger outlet tube (exhaust side cam shaft).
7. Remove the cooling fan.
8. Remove the radiator.
9. Remove auxiliary belt.
10. Remove the timing belt.
11. Remove the rocker cover.
12. Remove the cam shaft.
13. Remove the valve lifter.
14. Remove the adjustment shim from rear side of the valve lifter.

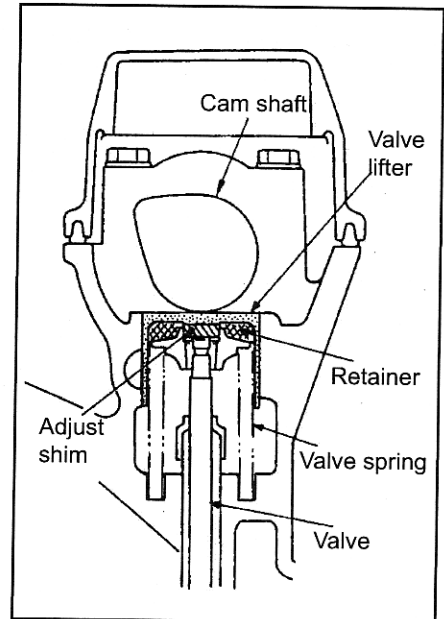

Adjustment

- Use the method below to select the adjustment shim:

Adjustment shim thickness formula (mm).

$$t = t_1 + (C_1 - C_2)$$

t = Adjustment shim thickness

t₁ = Removed shim thickness

C₁ = Measured valve clearance

C₂ = Standard valve clearance (when cold)

C₂ : 0.45 (intake)
0.38 (exhaust)

RB26DETT ENGINE

- Use the micrometer to measure the valve stem end surface (centre area) of the removed adjustment shim thickness (t_1).

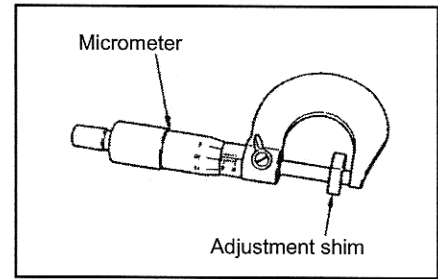

- Refer to the engraved marks on the adjustment shim to determine the shim thickness.

Example:

Mark	Shim thickness
'22	2.275 mm
75'	
'22	2.290 mm
90'	
.	.
.	.
.	.
'33	3.310 mm
10'	

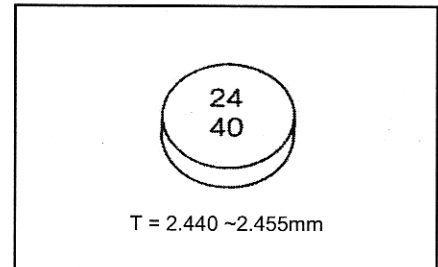

- There are total of 70 adjustment shim thickness.
- The range for adjustment shim thickness is between 2.275 ~ 3.310 mm.

Installation

- Install the selected adjustment shim to the reverse side of the valve lifter.
 - Face the adjustment shim with engraved side towards the valve lifter.
- Install the cam shaft and the cam timing pulley.
- Install the timing belt.
- Install the crank pulley.
- Turn the crank pulley twice.
- Make sure the valve clearance is within the standard value.
- Install the rest in reverse order to the removal procedure.

RB26DETT ENGINE

11. CYLINDER HEAD GASKET

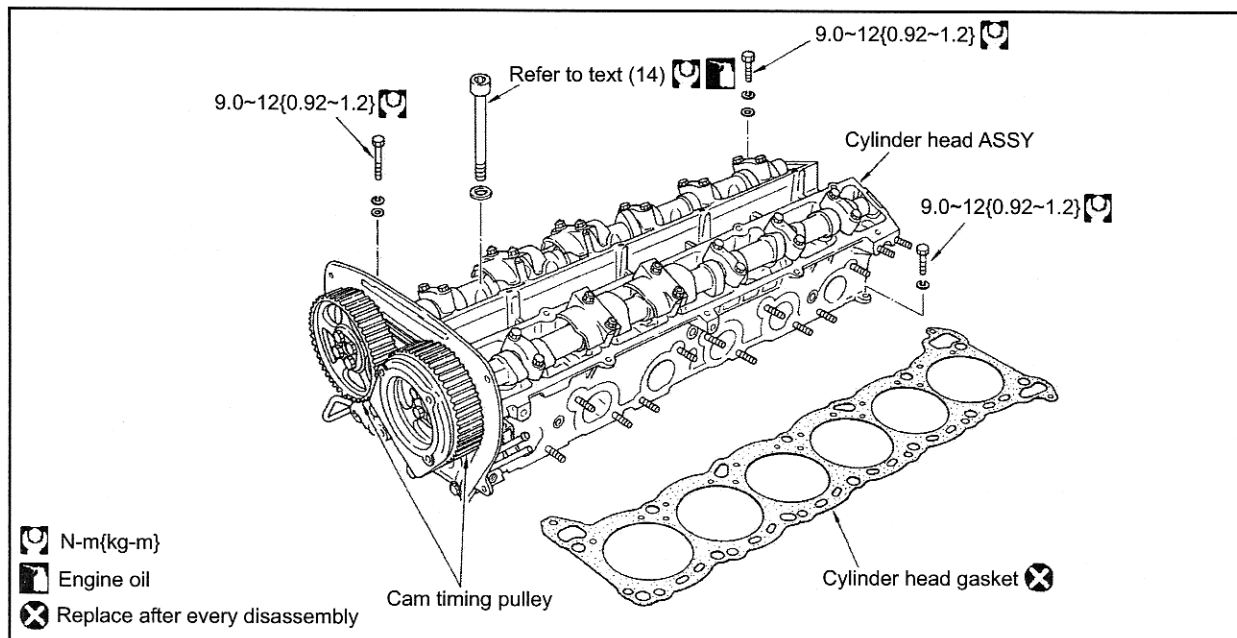
**Removal**

1. Release the fuel pressure.
2. Remove the battery negative terminal inside the boot.
3. Remove the front spoiler under cover (N1 vehicle).
4. Remove the under cover.
5. Drain coolant from the radiator drain plug.
6. Drain coolant from the cylinder drain plug.
7. Remove the exhaust front tube.
8. Remove the front strut tower bar.
9. Remove the cooling fan.
10. Remove the radiator.

[Engine right]

11. Remove the accelerator cable from the throttle drum.
12. Remove each hoses and the connectors from the fuel injector, intake manifold collector, intake manifold, and between the vehicle body and the cylinder block.

[Engine left]

13. Remove the air duct, air cleaner case and the air hose.
14. Remove the turbo-charger ASSY from the exhaust manifold side and lower it below the exhaust manifold.

[Engine front]

15. Remove auxiliary belt.
16. Remove the rocker cover.
17. Remove the timing belt.

Installation

1. Install the cylinder head gasket.
 - Use the scraper to remove old gasket on the installation surface.
 - Remove any water, grease and rubbish on the installation surface.
 - Align the dowel pin to install.
 - Replace the gasket with a new one.
2. Install the cylinder head ASSY.
 - Make sure the No. 1 cylinder is at T.D.C position.
 - Check No. 1 cylinder intake and exhaust valve is not lifted.
 - Care must be taken not to damage the cylinder head gasket when installing the cylinder head.
3. Tighten cylinder head bolts.
 - Coat thread parts and the bearing surface with engine oil.
 - Install the washer non-chamfered side facing the cylinder head.
4. Tighten the installation bolts in the order shown (1~14).
 - (1) Tighten to 29N-m {3kg-m}
 - (2) Tighten to 108N-m {11kg-m}
 - (3) Loosen to 0N-m {0kg-m} torque
 - (4) Tighten to 25~34N-m {2.5~3.5kg-m}
 - (5) Tighten to 85° ~ 90°
(OR 103~113N-m{10.5~11.5kg-m})
 - Install the cylinder head auxiliary bolts (15~17).
Tightening torque (N-m{kg-m}) 9.0~12{0.92~1.2}

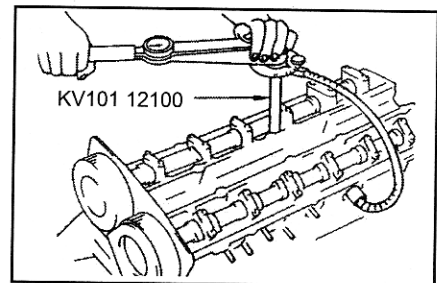
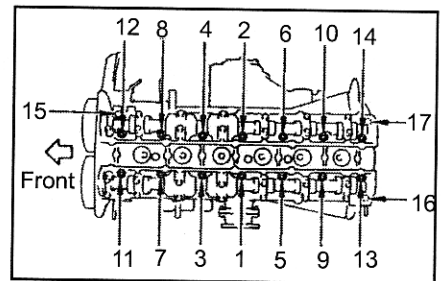
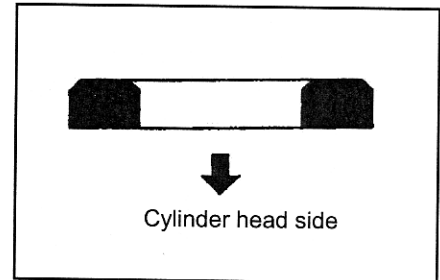
**Caution:**

Tightening angle should be checked using the angle wrench or protractor. Never estimate visually.

12. CYLINDER HEAD

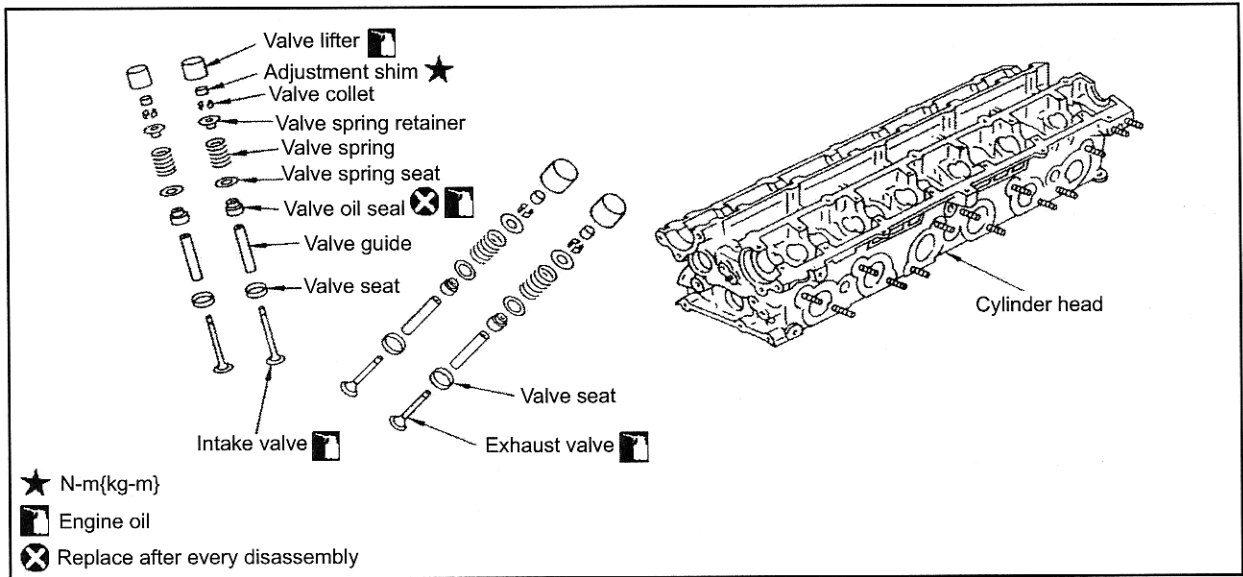

Removal & Installation

Refer to the cylinder head gasket for removal and installation operation of the cylinder head.

Disassembly

1. Remove the cam timing pulley and the rear timing belt cover.
2. Remove the cam shaft.
3. Remove the valve lifter and the adjustment shim.
4. Remove the valve collet.
 - Use the valve spring compressor to compress the valve spring. Use magnet screwdriver to remove the valve collet.
5. Remove the valve spring retainer.
6. Remove the valve spring.
7. Remove the valve by pushing the valve stem towards the combustion chamber.
 - Carry out the valve guide clearance inspection before removing the valve.
 - Check the installation position before removing the valve.
8. Remove the valve oil seal.
 - Use the oil seal puller to remove the valve oil seal.
9. Remove the valve spring seat.
10. Remove the valve guide.
11. Remove the valve seat.

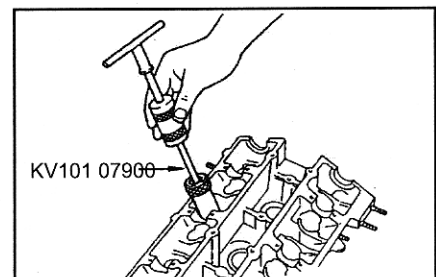
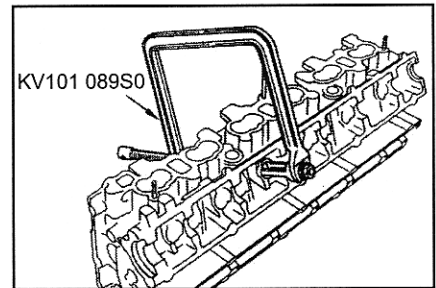

Inspection

Cylinder head distortion

- (1) Use the scraper to remove grease, water stain, carbon and gasket etc.

Caution:

Care must be taken not to allow removed gasket to enter oil and coolant passages.

- (2) Measure cylinder head under surface for distortion in six directions.

Limit value (mm) 0.2

- If the value exceeds the limit apply compound to press platen and readjust the surface. If the value exceeds the limit greatly, replace the cylinder head with a new one.

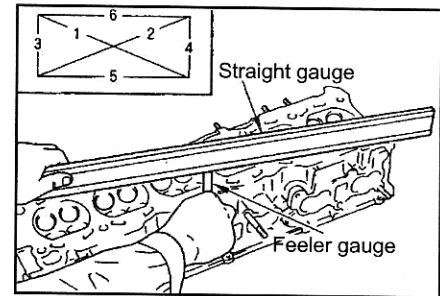

Valve measurement

Standard value (Intake)

a(mm)	100.88~101.08
b(mm)	97.3~97.6
Φc (mm)	34.58~34.7
Φd (mm)	5.965~5.980
e(mm)	1.3
f(mm)	2.6~2.9
α (o)	45°30'

Standard value (Exhaust)

a(mm)	99.88~100.08
b(mm)	95.33~95.63
Φc (mm)	30.0~30.2
Φd (mm)	6.905~6.920
e(mm)	1.2
f(mm)	2.9~3.2
α (o)	45°15'~45°45'

- Replace the valve with a new one if the exhaust valve is out of standard value.

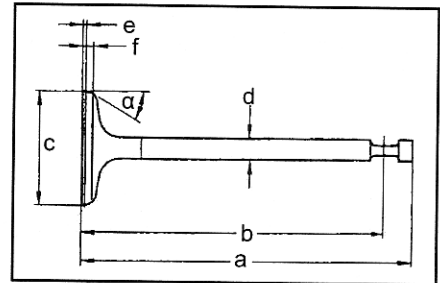

Valve guide clearance

- Carry out this inspection before removing the valve guide.
- Check if the valve stem diameter is at standard value.
- Extend the valve towards the combustion chamber for approx. 15mm. Move the valve to read the movement width on the dial gauge.

Standard value (mm)	intake	0.020~0.053
	exhaust	0.040~0.073
Limit value (mm)	intake	0.1
	exhaust	0.1

- Replace the valve guide with a new one if over the limit value.

RB26DETT ENGINE

Valve guide replacement

- Replace with oversize (0.5mm) valve guide when the valve guide is removed.
- (1) Use oil tank to heat up the cylinder head to approx. 150~160°.

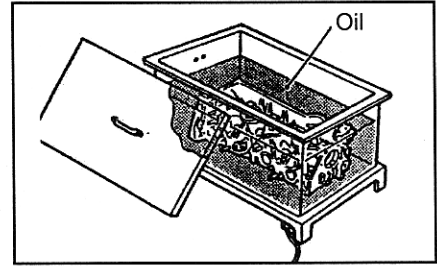

- (2) Use the valve guide drift to tap from the combustion chamber side to remove the valve guide.

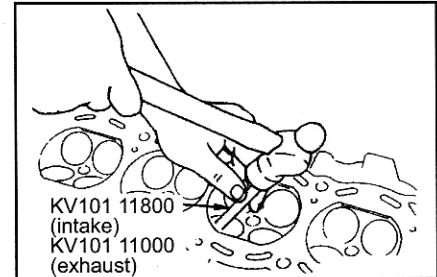

- (3) Use the valve guide reamer to ream the cylinder head guide hole.

Internal diameter standard value (mm)

Intake	Φ10.460 ~ 10.478
Exhaust	Φ11.460 ~ 11.478

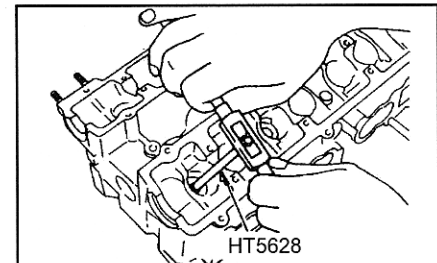

- (4) Heat the cylinder head to approx. 150~160°.
- (5) Use the valve guide drift to tap from the cam shaft side to insert the valve guide.

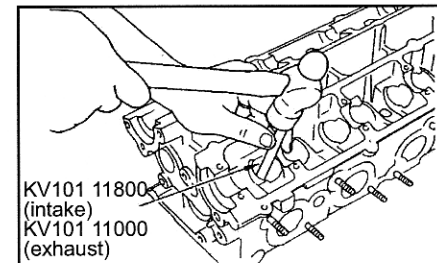

- The valve guide press-fit dimensions are shown in the figure.

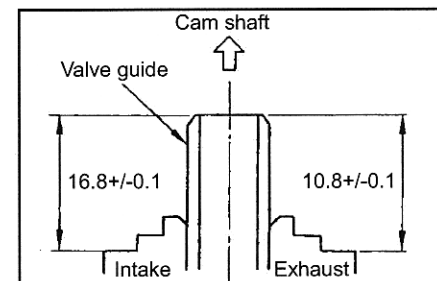

- (6) Readjust the valve guide using the valve guide reamer.

Finished standard value (mm)

Intake	Φ6.000 ~ 6.018
Exhaust	Φ7.000 ~ 7.018

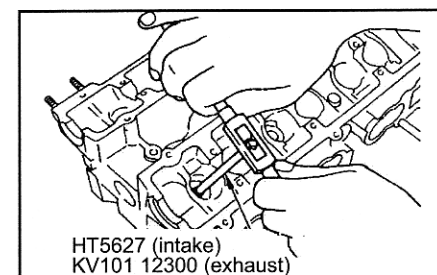

RB26DETT ENGINE

Valve seat inspection

- Carry out this inspection after checking the valve guide and the valve measurement.
- Check the valve seat and the valve face contact surface.
- Replace the valve seat if there is any abnormality or faults.

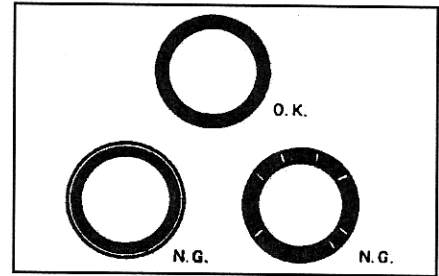

Valve seat replacement

- Replace with oversize (0.5mm) valve guide when the valve guide is removed.

- (1) Cut and grind the valve seat to remove the valve seat.
- (2) Readjust the mounting hole for oversize valve seat.
Valve seat diameter standard value (mm)

Intake	$\Phi 36.500 \sim 36.516$
Exhaust	$\Phi 32.500 \sim 32.516$

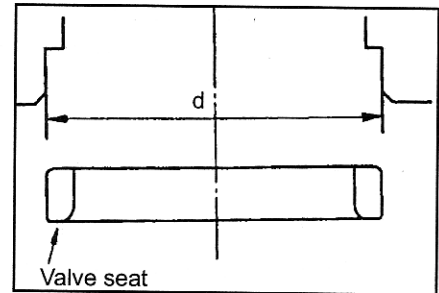

- (3) Heat up the cylinder head in an oil bath to approx. 110 ~ 130°.
- (4) Use dry ice to cool the valve seat. Use the valve seat drift to tap the valve seat.

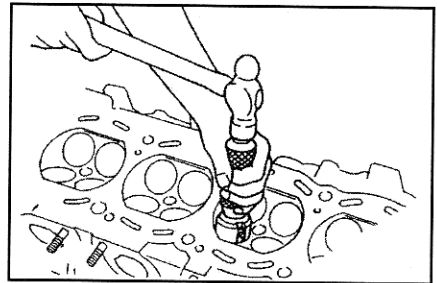
Caution:

Do not touch cooled valve seat with bare hands.

- (5) Readjust the valve seat using the valve seat cutter set and the valve seat grinder.

Standard measurement (mm)

Intake	$\Phi D1$: 36.597~36.613
	$\Phi D2$: 29.85~30.15
	$\Phi D3$: 32.0
	$\Phi D4$: 34.3
	$\Phi D5$: 37.5

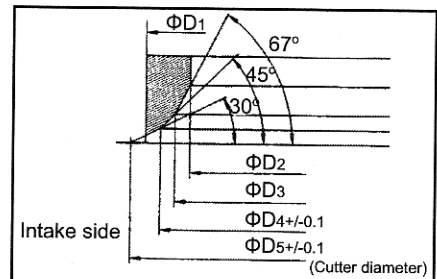

Exhaust	$\Phi D1$: 32.580~32.596
	$\Phi D2$: 24.85~25.15
	$\Phi D3$: 29.6
	$\Phi D4$: 32.5

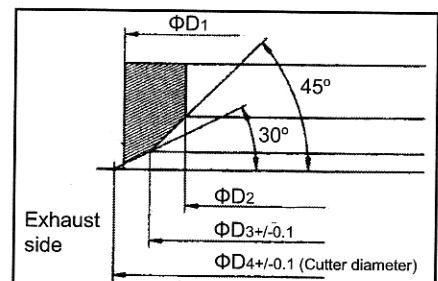
Caution:

When using the valve seat cutter make sure to hold the cutter with two hands and press firmly.

- (6) Use compound to adjust the valve measurement.
- (7) Recheck to make sure the contact surface is correct.

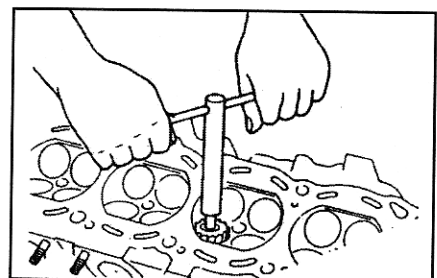

RB26DETT ENGINE

Valve spring squareness inspection

- Place a right-angle straight edge (L-square) so it is touching the spring. Turn the spring and measure the maximum clearance between the upper spring surface and the right angle surface to determine out-of-square distance.

Limit value (mm) 1.8

- Replace the valve spring if over the limit value.

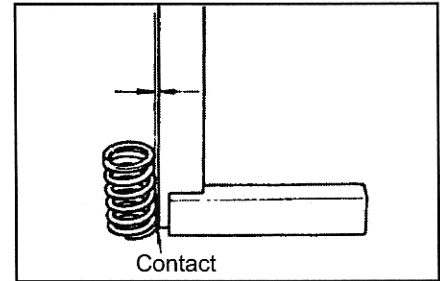

Free length and compression load inspection

- Use the valve spring tester.

Standard value:

Free length (mm)	46.54
Compression load (N{kg})	24.0
Compression length (mm)	35.0
Identification colour	White

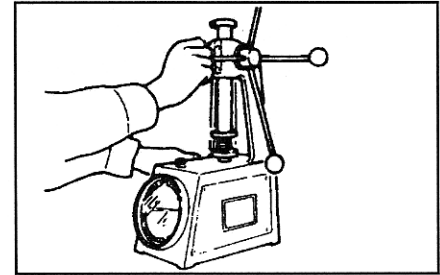

- Replace the valve spring with a new one if not at standard value.

Assembly

- Install the valve guide.
- Install the valve seat.
- Install the valve spring seat.
- Install the valve oil seal.
 - Use the valve oil seal drift to install new valve oil seal.
 - Apply engine oil to valve guide and valve oil seal lip surface.
 - Install as shown in the figure.

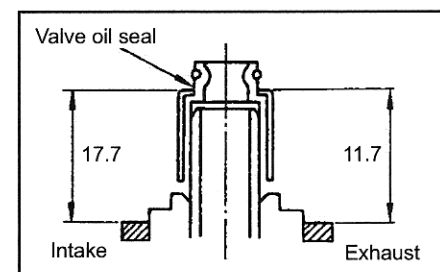
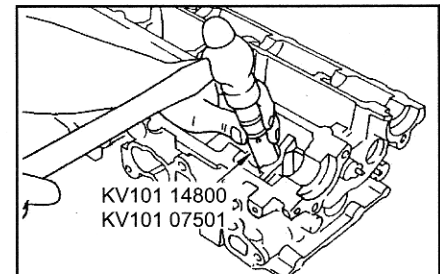

- Install the valve.
 - Apply engine oil to valve stem.
- Install the valve spring.
 - Install the valve spring with the narrow end pitch towards the cylinder head (identification colour side down).

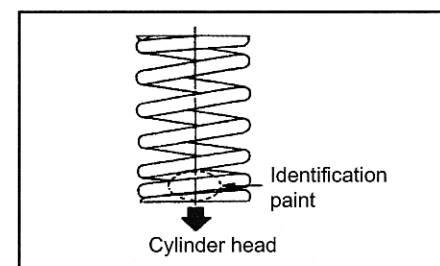

RB26DETT ENGINE

7. Install the valve spring retainer.
8. Install the valve collet.
 - Use the valve spring compressor to compress the valve spring. Use a magnet screwdriver to install the valve collet.
 - Use plastic hammer to tap the stem surface to check if it is installed correctly.

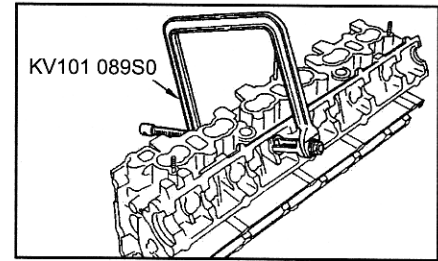

9. Install the adjustment shim and the valve lifter.
10. Install the cam shaft.
11. Install the rest in reverse order to the removal procedure.

13. CYLINDER BLOCK

Caution:

At disassembly

- Always make sure to use correct tools where mentioned and only carry out possible operations.
- Place marks on the disassembled parts so it can be assembled correctly. Make sure they are stored correctly.
- Tighten the bolts and nuts in the correct order shown.

At inspection, repairing and replacing

- Follow the inspection points and only replace or repair where necessary. Only replace the old parts with same types of new parts.

At assembly

- Always use torque wrench when tightening the nuts and bolts.
- Use the angle wrench or the protractor to check the tightening angle of the conrod nut.
- Tighten installation bolts and nuts in the order shown in several stages.
- Clean and air blow with air gun each parts especially the oil and coolant passage.
- Always replace the gasket, packing, oil seal and the o-ring with new ones after each disassembly.
- Care must be taken not to damage alignment surface and the rotational area. Remove all foreign objects and apply engine oil.

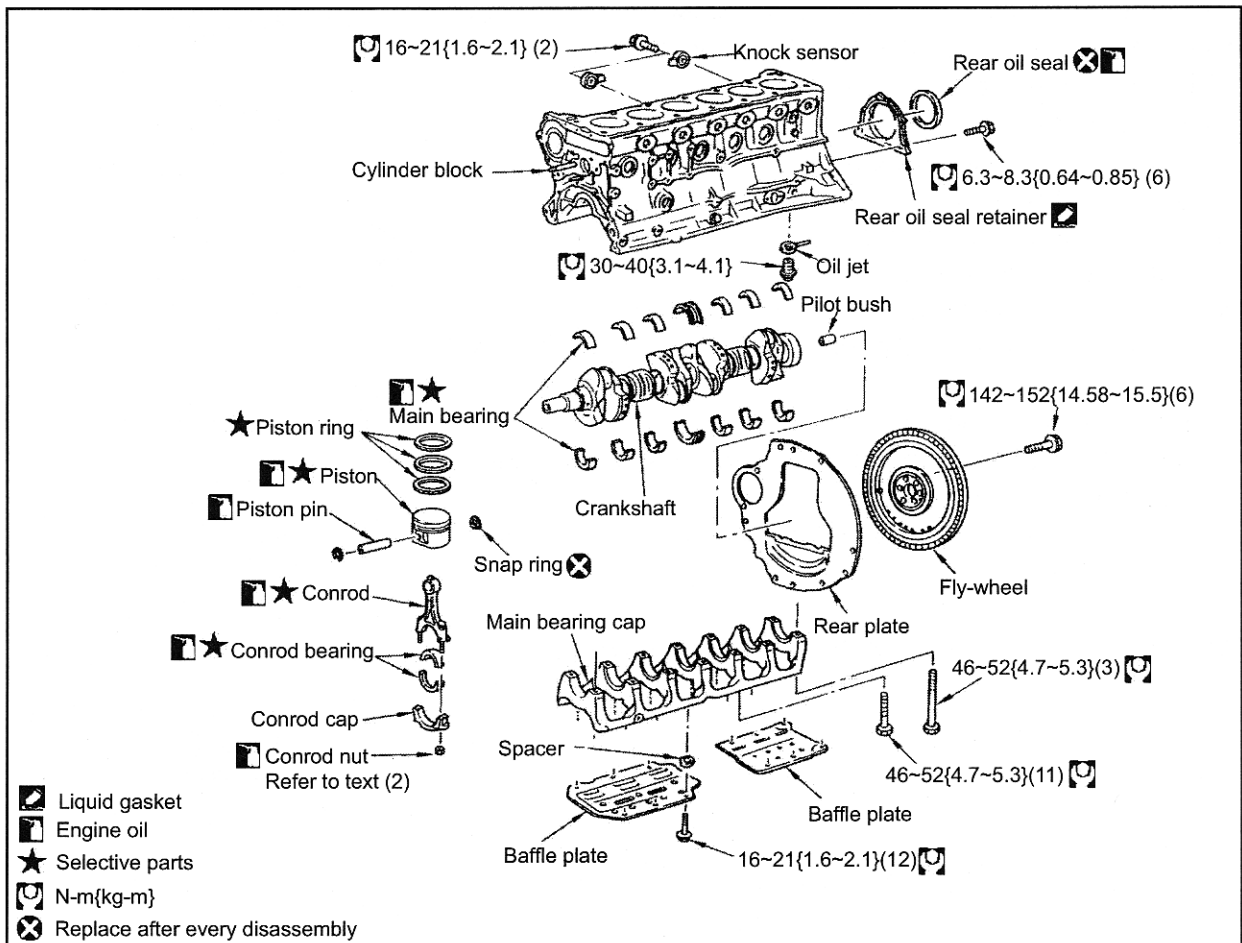

RB26DETT ENGINE

Disassembly

1. Remove the engine / transmission / transfer ASSY from the vehicle.
2. Remove the transmission / transfer ASSY from the engine.
3. Remove the engine mount from the cylinder block.
4. Drain coolant from the cylinder block drain plug.
5. Remove the oil filter.
6. Remove the oil filter bracket and the cooling type oil cooler.
7. Install the engine ASSY to the engine stand.

- (1) Attach the engine sub attachment to the right side of the cylinder block.

Tightening torque (N-m{kg-m}) 39~49{4.0~5.0}

- (2) Attach the engine attachment to the engine sub attachment.

Tightening torque (N-m{kg-m}) 39~49{4.0~5.0}

- (3) Hoist the engine ASSY and attach it to the engine stand.

8. Drain engine oil from the oil pan drain plug.
9. Remove the engine slinger.
10. Remove the alternator.
11. Remove the turbo-charger ASSY.
12. Remove the air conditioner compressor bracket.
13. Remove the power steering pump bracket.
14. Remove the rocker cover.
15. Remove the timing belt.
16. Remove the cylinder head.
17. Remove the oil pan and the oil filter.
18. Remove the water pump.
19. Remove the oil pump.
20. Remove the water inlet and the thermostat.
21. Remove two knock sensors from right side of the cylinder block.
22. Remove the fly-wheel.
 - Use the ring gear stopper to fix and remove the installation bolts.
 - Carry out the wheel run-out inspection before removing the fly-wheel.

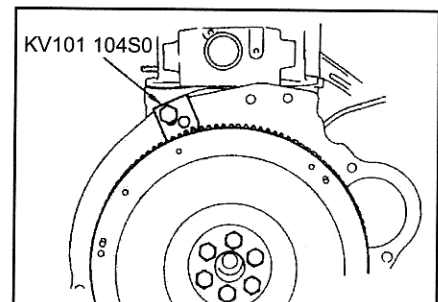
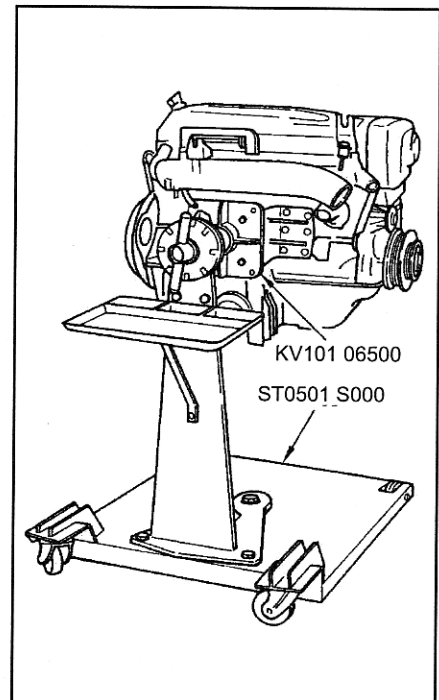
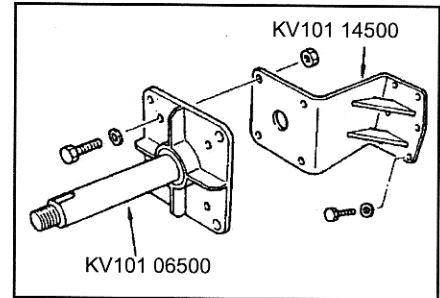

23. Remove the baffle plate from the main bearing cap.

RB26DETT ENGINE

24. Use the pilot bush puller to remove the pilot bush.

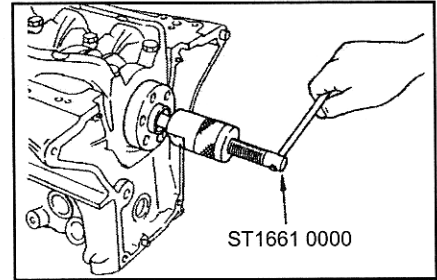

25. Remove the rear plate.

26. Remove the rear oil seal retainer.

- Use a screwdriver to remove the retainer.

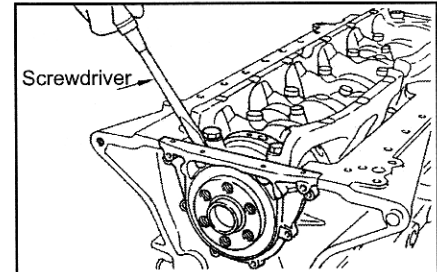

27. Remove the rear oil seal.

- Use a screwdriver to remove the oil seal.

Caution:

Care must be taken not to damage the rear oil seal retainer.

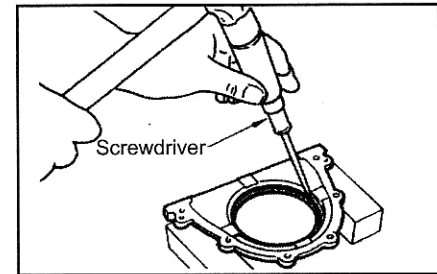

28. Remove the baffle plate.

29. Remove the piston and the conrod ASSY.

(1) Position the crankshaft pin to B.D.C (bottom dead centre) position.

(2) Remove the conrod cap and use handle end of the hammer to push it out to the cylinder head side.

- Carry out the conrod side clearance inspection before removing the piston / conrod ASSY.

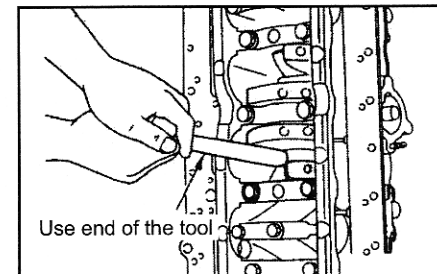

- Push the conrod towards the left direction so it will not interfere with the oil jet.

(3) Remove the conrod bearing.

Caution:

Check the installation position before removing the conrod bearing.

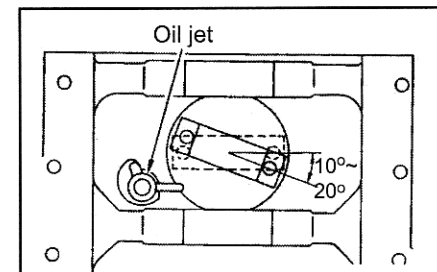

30. Remove the piston ring from the piston.

- Use the piston ring expander.

Caution:

Care must be taken not to damage the piston.

Do not over expand the piston ring.

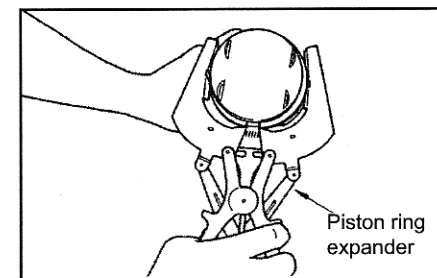

31. Remove the piston from the conrod.

(1) Use the snap ring plier to remove the snap ring.

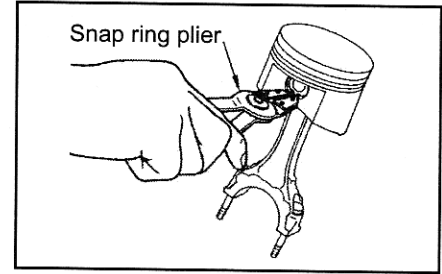

(2) Heat up the piston using a heat gun to approx. 60~70°.

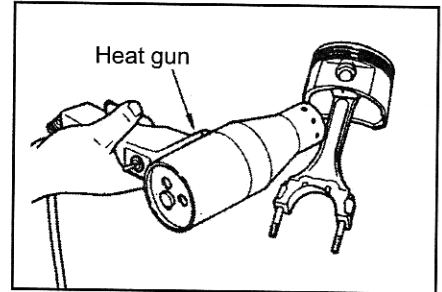

(3) Push the piston out using a round bar with diameter $\Phi 20\text{mm}$.

Caution:

Do not remove the conrod bolt from the conrod.

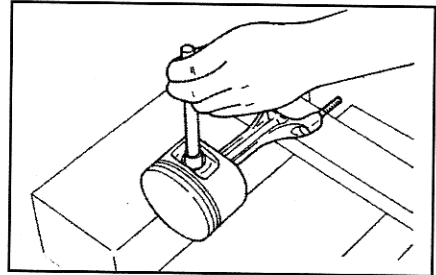

32. Remove the main bearing cap.

- Loosen and remove the installation bolts in order shown in several stages.
- Carry out the crankshaft side clearance inspection before loosening the main bearing cap bolts.

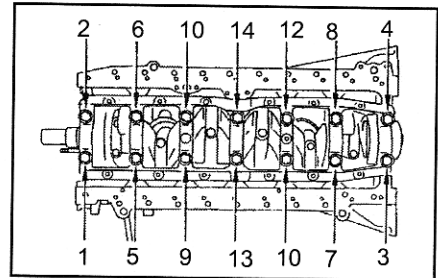

- Use the screwdriver to remove the main bearing cap.

Caution:

Care must be taken not to damage the oil pan seal surface.

33. Remove the crankshaft.

34. Remove the main bearing from the main bearing cap and cylinder block.

Caution:

Check installation position before removing the parts.

35. Remove the oil jet.

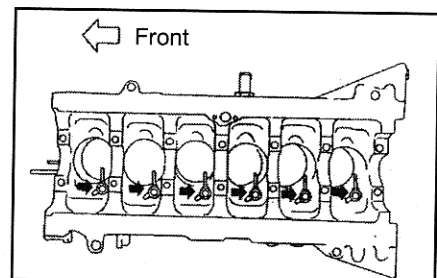
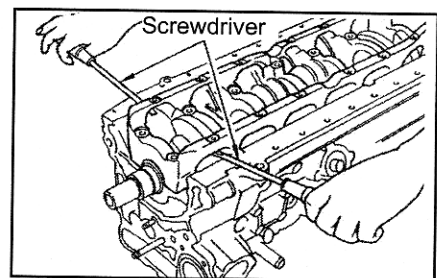

Inspection

Crankshaft side clearance

- Use the dial gauge or the feeler gauge to measure clearance between the thrust bearing and the crank arm when the crankshaft is moved forwards or backwards.

Standard value (mm)	0.05 ~ 0.18
Limit value (mm)	0.3

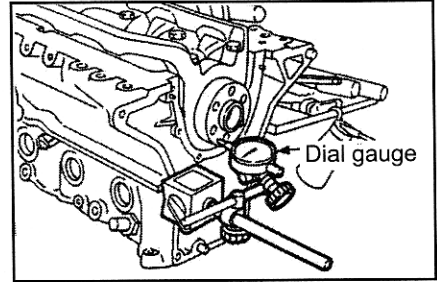

- If the measurement is over the limit value replace No.4 bearing (thrust bearing) to new one and remeasure the crankshaft side clearance. Replace the crankshaft if the value is still over limit.

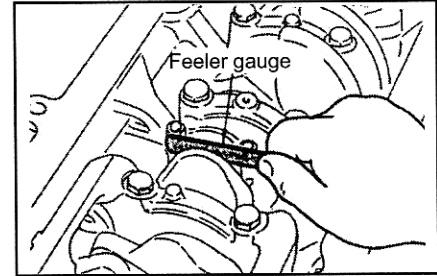

Conrod side clearance

- Use the feeler gauge to measure the side clearance between the conrod and the crank arm.

Standard value (mm)	0.2 ~ 0.3
Limit value (mm)	0.4

- If the measurement is over the limit value replace the conrod to new one and remeasure the conrod side clearance. Replace the crankshaft if the value is still over limit.

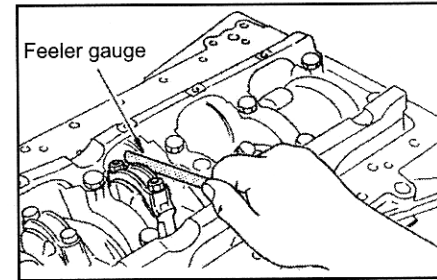

Piston and piston pin clearance

(Piston pin inside diameter)

- Use the inside micrometer to measure the piston pin inside diameter.

Standard value (mm)	Grade O	Φ20.987~20.993
	Grade I	Φ20.993~20.999

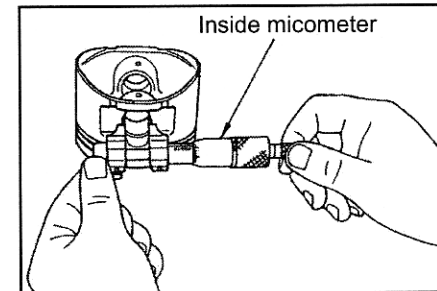

(Piston pin outer diameter)

- Use the micrometer to measure the piston pin outer diameter.

Standard value (mm)	Grade O	Φ20.989~20.995
	Grade I	Φ20.995~21.001

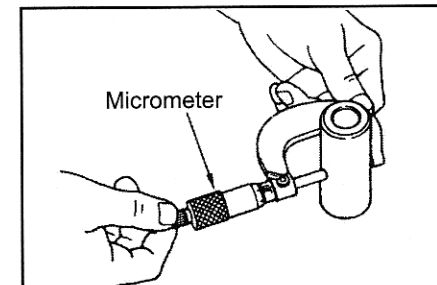

(Piston pin clearance) =

(Piston pin inside diameter) - (Piston pin outer diameter)

Standard value at room temperature (20°C) (mm)

-0.004 ~ 0

RB26DETT ENGINE

- If the value is not at standard value, make sure the conrod small end inside diameter is within the standard value. Select the piston pin grade according to the measurement range and replace the piston pin / piston pin ASSY with new one with the same piston pin grade.

Standard value (mm)	Grade O	$\Phi 21.000 \sim 21.006$
	Grade I	$\Phi 21.006 \sim 21.012$

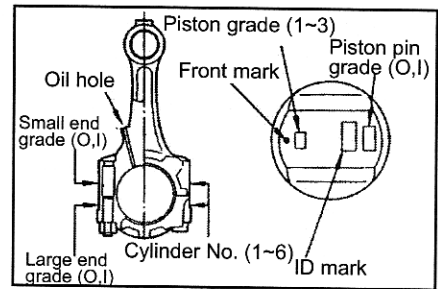

Piston ring side clearance

- Use the feeler gauge to measure between the piston ring and the piston ring groove.

Standard value (mm)	Top ring	0.040~0.075
	Second ring	0.030~0.065
	Oil ring	0.065~0.135

Limit value (mm)	Top & second ring	0.1
------------------	-------------------	-----

- If the value is over the limit replace the piston or the piston ring ASSY.

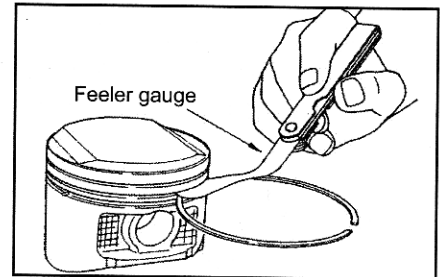

Piston ring closed gap

- Make sure the cylinder bore inner diameter is within the standard value.
- Use the piston to insert the piston ring to the cylinder intermediate position to measure the closed gap.

Standard value (mm)	Top ring	0.24~0.34
	Second ring	0.42~0.57
	Oil ring	0.20~0.60

- Replace the piston ring if not within the standard value.

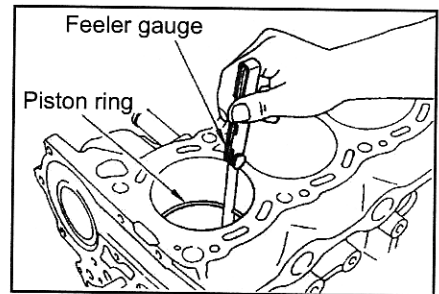

Conrod bend and torsion

- Use the conrod aligner to inspect.
- | | |
|--------------------------|--------------------|
| Bend limit value (mm) | 0.15 (every 100mm) |
| Torsion limit value (mm) | 0.3 (every 100mm) |
- Replace the conrod ASSY if over the limit value.

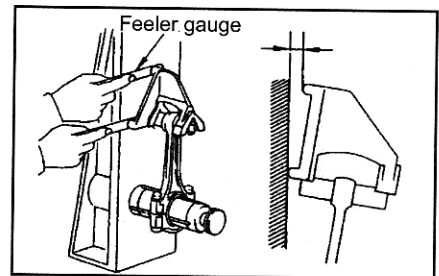

Conrod large end diameter

- Use the inside micrometer to measure the conrod large end inner diameter by first placing the conrod cap without conrod bearing and tightening the conrod nut to standard tightening torque.

Standard value (mm)	Grade O	$\Phi 51.000 \sim 51.007$
	Grade I	$\Phi 51.007 \sim 51.013$

- Replace the conrod if not within standard value.

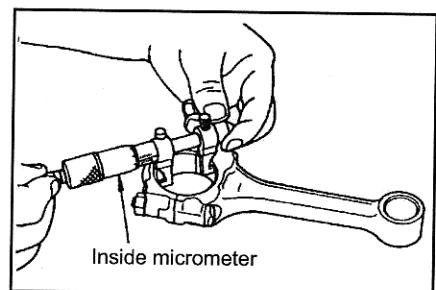

RB26DETT ENGINE

Conrod bush clearance (small end)
(Conrod small end inner diameter)

- Use the inside micrometer to measure small end inner diameter.

Standard value (mm)	Grade O	$\Phi 21.000 \sim 21.006$
	Grade I	$\Phi 21.006 \sim 21.012$

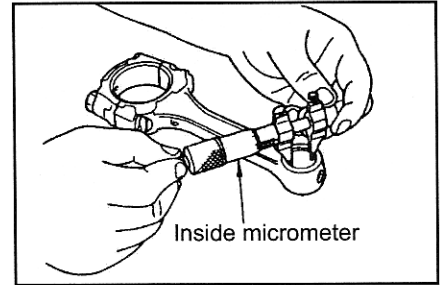

(Piston pin outer diameter)

- Use the micrometer to measure the piston pin outer diameter.

Standard value (mm)	Grade O	$\Phi 20.989 \sim 20.995$
	Grade I	$\Phi 20.995 \sim 21.001$

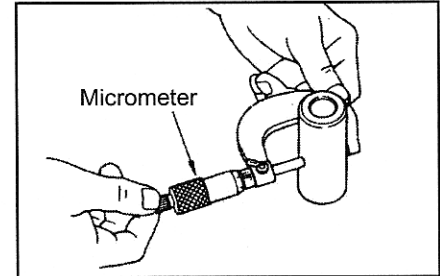

(Conrod bush oil clearance) =
(Conrod small end inner diameter) -
(Piston pin outer diameter)

Standard value (mm)	0.005~0.017
---------------------	-------------

- If not within the standard value recheck each measurement. If still not within the standard value replace either conrod ASSY, piston / piston pin ASSY or replace both.
- If replacing both parts, make sure to match the piston / piston pin ASSY pin grade and the conrod small end grade.
- If replacing either conrod ASSY or the piston / piston pin ASSY, measure and use the parts with the same grade.

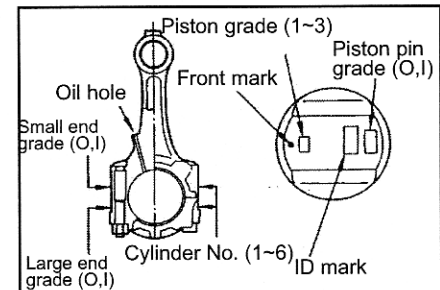

Cylinder block top surface distortion

- Use a scraper to completely remove gasket, grease, water stains and carbon etc. on cylinder block front surface.

Caution:

Care must be taken not to allow removed gasket to enter oil and coolant passages.

- Measure distortion of the block top surface in six directions using the straight gauge.

Limit value (mm)	0.1
------------------	-----

- If the value is over the limit use a surface grinder to correct the distortion. Replace the cylinder block if the distortion is too great.

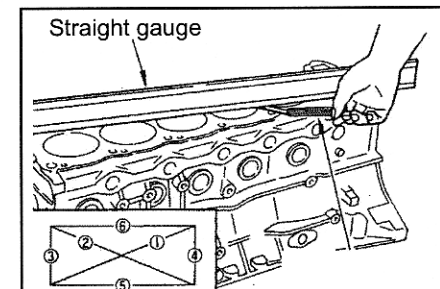

RB26DETT ENGINE

Main bearing housing inner diameter

- Place a main bearing cap without installing the main bearing. Tighten the tightening bolts to specified tightening torque.
- Use the bore gauge to measure main bearing housing inner diameter.
Standard value (mm) $\Phi 58.645\sim 58.670$
- Replace the cylinder block, the main bearing cap ASSY if the value is not within the standard value.

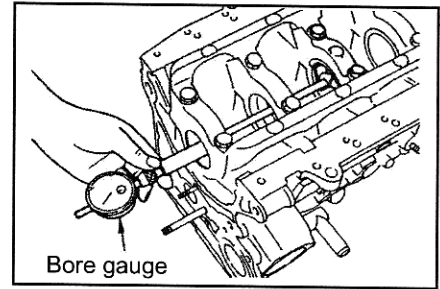

Piston to cylinder bore clearance
(Cylinder bore inner diameter)

- Use the bore gauge to measure the cylinder inner diameter in a total of six positions. Top, centre and bottom (A, B, C) and in two directions (X, Y).
Cylinder inner diameter standard value (mm) $\Phi 86.000\sim 86.030$
- Wear out limit value (mm) 0.2
- Elliptic limit value (X, Y difference)(mm) 0.015
- Taper limit value (A, C difference) (mm) 0.010
- If the measurement value is over the limit value or the cylinder inner wall is damaged or burnt conduct honing or boring.
- The piston oversize is set at 0.5 OS (0.5mm oversize) or 1.0 OS (1.0mm oversize) at the time of service. When using the oversize piston conduct honing on the cylinder, so the piston cylinder clearance is between 0.035~0.055mm. Also use oversize piston rings for oversize piston.

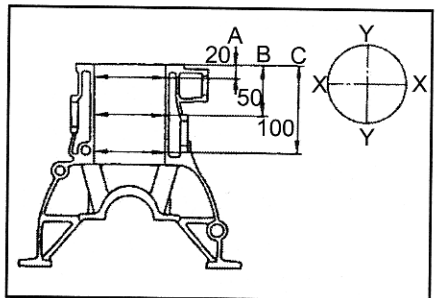
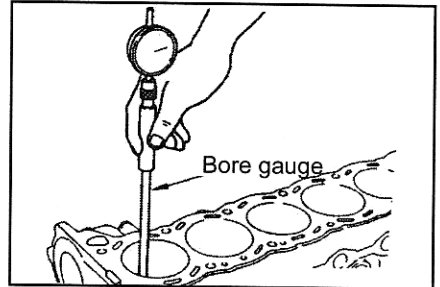

Piston outer diameter

- Use the micrometer to measure the outer diameter of the piston skirt.
Measurement position: 13mm from the piston foot
Standard value (mm) $\Phi 85.955\sim 85.985$

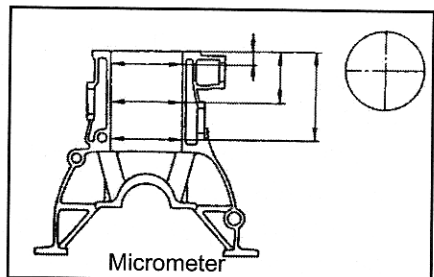

(Clearance) =
(Cylinder inner diameter) - (Piston skirt area diameter)
Standard value at room temperature (20°C)

0.035~0.055

- If the clearance is not at standard value, replace the piston by selecting the correct grade using the table below.

Grade No. (Engraved)		1		2		3	
Cylinder bore inner diameter		86.010		86.020		86.030	
		86.000		86.010		86.020	
Piston	Outer diameter	85.965		85.975		85.985	
	Pin grade	85.955		85.965		85.975	
		O	I	O	I	O	I

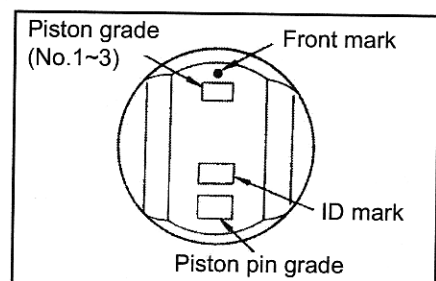

RB26DETT ENGINE

Caution:

The piston is selected together with the piston pin ASSY. When replacing the piston refer to the conrod bush oil clearance section to select the piston pin grade.

Reference:

Select the piston with the same grade as the cylinder block left upper surface bore grade engravings when using the new cylinder block.

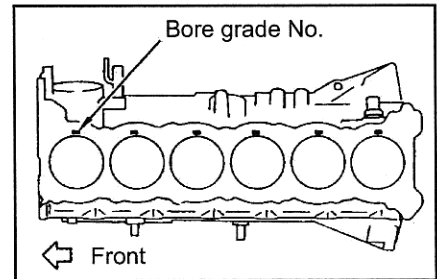
**Crankshaft journal diameter**

- Use the micrometer to measure journal diameter.
Standard value (mm) $\Phi 54.951 \sim 54.975$

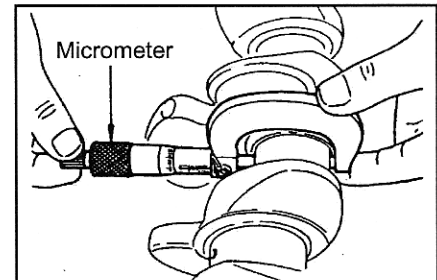
**Crankshaft pin diameter**

- Use the micrometer to measure the outer diameter of the pin.
Standard value (mm) $\Phi 41.961 \sim 41.974$

Crankshaft ellipticity and taper

- Use the micrometer to measure each journal and the pins for each direction as shown in the figure.
- Ellipticity can be determined by the difference between measurement A and B.

$$\text{Ellipticity} = A - B$$

- Taper can be determined by the difference between measurement 1 and 2.

$$\text{Taper} = 1 - 2$$

Limit value for ellipticity and taper (mm) 0.05

- If the value is over the limit replace with a new one.

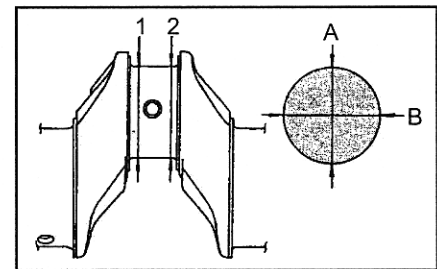
**Crankshaft run-out**

- Use V-block on fixed surface and support the crankshaft journal.
- Set the dial gauge vertically to No. 4 journal.
- Crankshaft run-out is equal to half the movement width indicated in the dial gauge.

Limit value (mm) 0.05

- If the run-out is over the limit value replace the crankshaft.

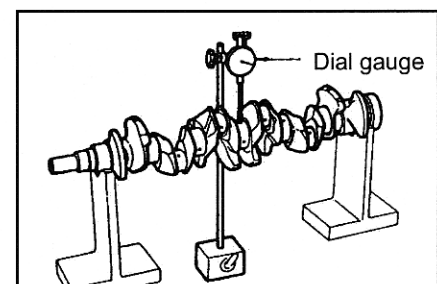

Conrod bearing oil clearance

Method A

- Use the inside micrometer to measure the conrod bearing inner diameter. First instal the conrod bearing to the conrod and tighten the conrod nut to specified tightening torque.

(Oil clearance) =

$$\begin{aligned} & (\text{Conrod bearing inner diameter}) - \\ & (\text{Crankshaft pin diameter}) \end{aligned}$$

Standard value (mm) 0.020~0.040

Limit value (mm) 0.090

- If the measurement is over the limit value replace the conrod bearing.

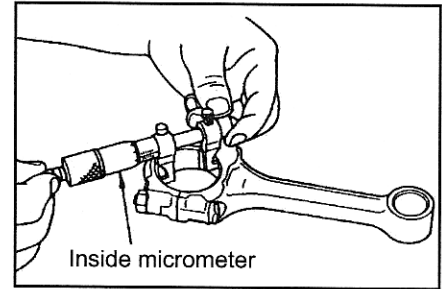

Method B (using the plastigauge)

- Remove all dust and foreign objects from the crankshaft pin and the bearing surface.
- Cut off a piece of plastigauge slightly shorter than the bearing width. Place the plastigauge on the crankshaft axle direction avoiding the oil hole.
- Assemble the conrod bearing to the conrod cap and tighten the conrod nut to specified tightening torque.

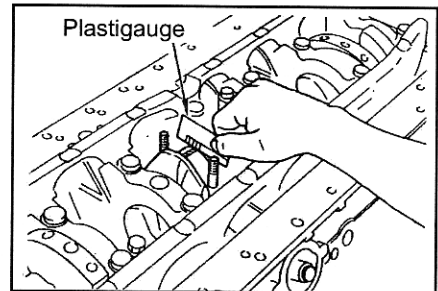
Caution:

Do not turn the crankshaft.

- Remove the conrod cap and the bearing and measure the plastigauge width using the plastigauge scale.

Conrod bearing selection

- Select the conrod bearing from the selection chart below.

(mm)

Conrod large end inner diameter			$\Phi 51.007$ $\Phi 51.000$	$\Phi 51.013$ $\Phi 51.007$
Crank pin diameter	Grade No. (Engraved)		O	I
$\Phi 47.974$ $\Phi 47.968$	0	Bearing grade No. Bearing thickness (mm) Oil clearance (mm) Identification colour	STD 0 1.500~1.503 0.020 / 0.039 None	STD 1 1.503~1.506 0.021 / 0.039 Brown
$\Phi 47.968$ $\Phi 47.961$	1	Bearing grade No. Bearing thickness (mm) Oil clearance (mm) Identification colour	STD 1 1.503~1.506 0.020 / 0.040 Brown	STD 2 1.506~1.509 0.021 / 0.040 Green

Reference:

If the conrod is new check with the large end grade engravings with the selection chart.

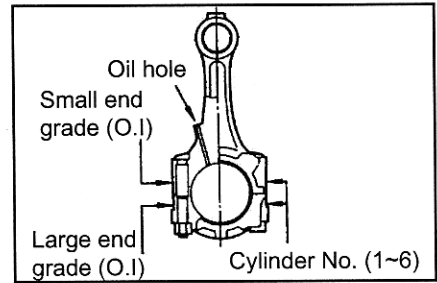

If the crank shaft is new check with the crankshaft surface pin grade engravings with the selection chart.

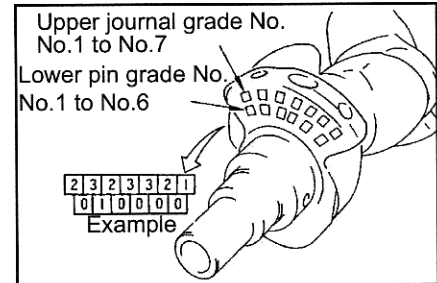

Using under size bearing

- Under size bearing can be used if oil clearance can not be adjusted to standard value when the standard size conrod bearing is used to measure the oil clearance.
- When using the under size bearing, measure the bearing inner diameter and grind the pin in order to adjust the oil clearance to standard value.

Bearing under size chart (mm)

Size	Thickness	Grade No.
US0.08	1.541 / 1.549	8
US0.12	1.561 / 1.569	12
US0.25	1.626 / 1.634	25

Caution:

Care must be taken not to damage the fillet R when grinding the crank pin to use an under size bearing.

Main bearing oil clearance

Method A

- Install the main bearing to the cylinder block and the conrod cap and tighten the main bearing bolt to specified tightening torque. Measure the main bearing inner diameter.

(Oil clearance) =
 (Main bearing inner diameter) -
 (Crankshaft journal diameter)

Standard value (mm) 0.028~0.046

Limit value (mm) 0.090

- If the measurement is over the limit value replace the main bearing.

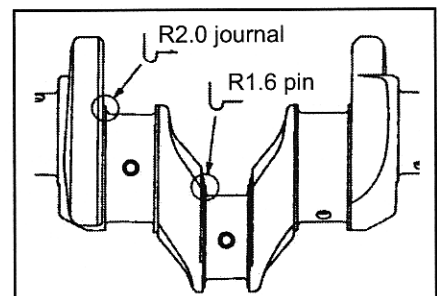

RB26DETT ENGINE

Method B (using the plastigauge)

- Remove all dust and foreign objects from the crankshaft journal and the bearing surface.
- Cut off a piece of plastigauge slightly shorter than the bearing width. Place the plastigauge on the crankshaft axle direction avoiding the oil hole.
- Tighten the main bearing to the specified tightening torque.

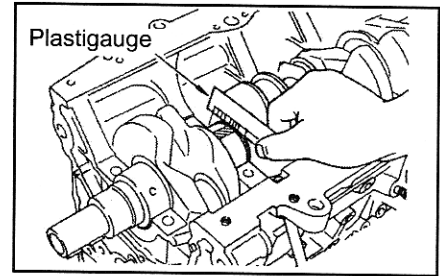
**Caution:**

Do not turn the crankshaft.

- Remove the bearing cap and the bearing to measure the plastigauge width using the plastigauge scale.

Main bearing selection

- Select the main bearing from the selection chart below.

(mm)

Cylinder block bearing housing inner diameter			<u>58.651</u> 58.645	<u>58.657</u> 58.651	<u>58.663</u> 58.657	<u>58.670</u> 58.663
Crank journal diameter	Grade No. (Engraved)		0	1	2	3
<u>54.975</u> 54.969	0	Bearing grade No. Bearing thickness (mm) Oil clearance (mm) Identification colour	STD 0 1.818~1.821 0.028 / 0.046 Black	STD 1 1.821~1.824 0.028 / 0.046 Brown	STD 2 1.824~1.827 0.028 / 0.046 None	STD 3 1.827~1.830 0.028 / 0.047 Yellow
<u>54.969</u> 54.963	1	Bearing grade No. Bearing thickness (mm) Oil clearance (mm) Identification colour	STD 1 1.821~1.824 0.028 / 0.046 Brown	STD 2 1.824~1.827 0.028 / 0.046 None	STD 3 1.827~1.830 0.028 / 0.046 Yellow	STD 4 1.830~1.833 0.028 / 0.047 Blue
<u>54.963</u> 54.957	2	Bearing grade No. Bearing thickness (mm) Oil clearance (mm) Identification colour	STD 2 1.824~1.827 0.028 / 0.046 None	STD 3 1.827~1.830 0.028 / 0.046 Yellow	STD 4 1.830~1.833 0.028 / 0.046 Blue	STD 5 1.833~1.836 0.028 / 0.047 Green
<u>54.957</u> 54.951	3	Bearing grade No. Bearing thickness (mm) Oil clearance (mm) Identification colour	STD 3 1.827~1.830 0.028 / 0.046 Yellow	STD 4 1.830~1.833 0.028 / 0.046 Blue	STD 5 1.833~1.836 0.028 / 0.046 Green	STD 6 1.836~1.839 0.028 / 0.047 Pink

Reference:

Depending on the installation position the measurement and the feature size will be different.

No.1 ~ No.3, No.5 ~ No.7 upper side (with groove)

No.1 ~ No.3, No.5 ~ No.7 lower side (without groove)

No.4 upper side (Thrust bearing, with groove)

No.4 lower side (Thrust bearing, without groove)

- If the crank shaft is new, check the crank shaft front surface journal grade No. engravings with the selection chart.

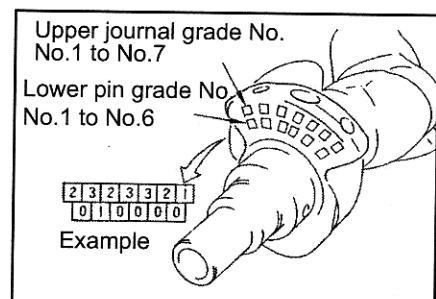

RB26DETT ENGINE

- If the cylinder block is new check the cylinder block bottom surface housing inner diameter grade No. engravings with the selection chart.

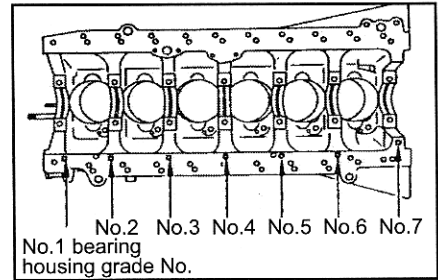

Using under size bearing

- Under size bearing can be used if oil clearance can not be adjusted to standard value when the standard size main bearing is used to measure the oil clearance.
- When using the under size bearing, measure the bearing inner diameter and grind the pin in order to adjust the oil clearance to standard value.

Bearing under size chart

Size	Thickness
US0.25	1.950 / 1.958

(mm)

Caution:

Care must be taken not to damage the fillet R when grinding the crank pin to use an under size bearing.

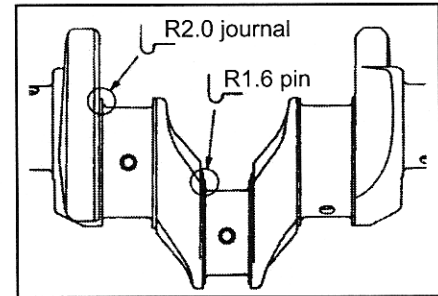

Main bearing crush height

- When the main bearing is installed tighten the bearing cap to specified tightening torque and when the cap is removed the bearing tip is projecting.
- Replace the part when there is no main bearing crush height.

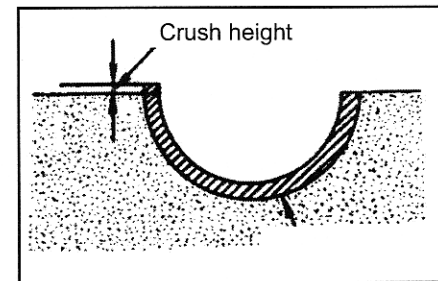

Fly-wheel run-out

- Use a dial gauge to measure the run-out of the fly-wheel clutch plate working face.
Limit value (mm) 0.10
- Replace the fly-wheel when the value is over the limit.

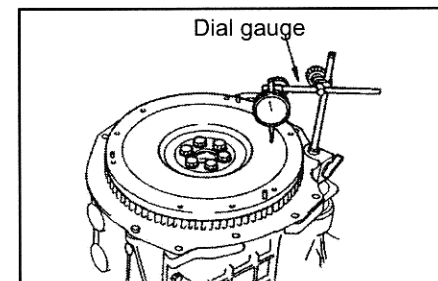

Oil jet

- Check the nozzle for any deformation or damage.
- Blow compressed air from the nozzle side and check if there is any blockage.
- Clean or replace the oil jet if there is any abnormality.

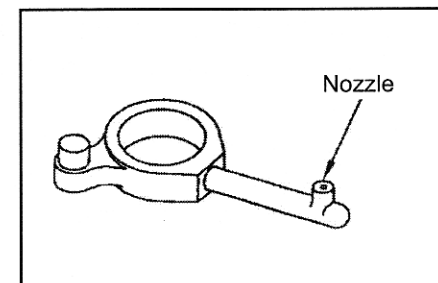

RB26DETT ENGINE

Oil jet eye bolt

- Use a clean stick to push the check valve inside the eye bolt. Check if it move smoothly with moderate resistant force.
- Replace with a new one if there is any abnormality.

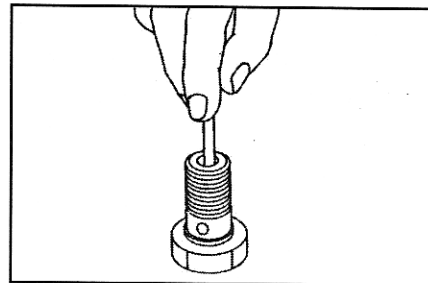
**Assembly**

1. Use the air gun to blow compressed air through the cylinder block coolant passage, oil passage, inside the crank case and inside the cylinder bore to remove any foreign objects.

2. Install the oil jet.

Tightening torque (N-m{kg-m}) 30~40{3.1~4.1}

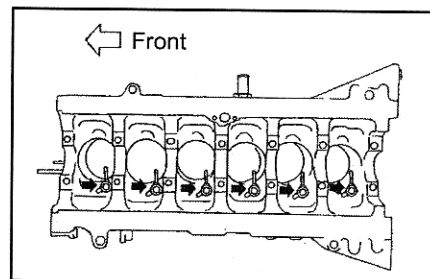

3. Install the main bearing.

- (1) Remove any rubbish, dust, grease etc. from the cylinder block and the main bearing cap bearing installation surface.

- (2) Care must be taken with the main bearing installation direction.

- Install side with the oil hole and the groove to the cylinder block side, and the side without the oil hole and the groove to main cap side.
- Coat engine oil to the bearing surface (inner) when installing the bearing. Do not apply engine oil to the reverse side but clean sufficiently.
- Make sure the cylinder block oil hole and the bearing oil hole position is correct.

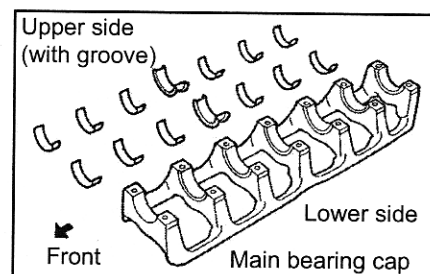

4. Install the crankshaft to the cylinder block.

5. Install the main bearing cap.

- Apply engine oil to the installation bolts thread area.
- Longer bolts are used for positions 1, 11 and 12.
- Tighten the installation bolts in the order shown in the figure.

Tightening torque (N-m{kg-m}) 46~52{4.7~5.3}

- After securing the bolts make sure the crankshaft turns smoothly by hand.

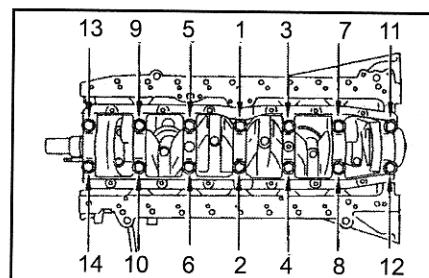

RB26DETT ENGINE

6. Install the piston to the conrod.

(1) Use the snap ring plier to install the snap ring to the piston rear side installation groove.

- Use new snap ring.
- Install so the chamfered side is facing the piston pin.
- Make sure to fit into the piston installation groove securely.

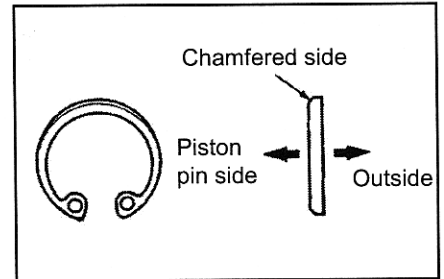

(2) When the piston front mark is faced towards the engine front, the conrod oil hole must be on the left side when seen from the engine front.

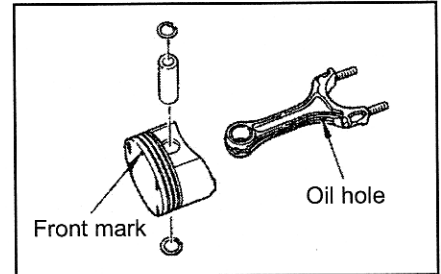

(3) Heat up the piston using a industrial heat gun (to approx. 60~70°C) then insert the piston pin into the piston and the conrod from the piston front.

- At the time of insertion make sure to apply plenty of oil to the pin, pin hole and the conrod small end parts.

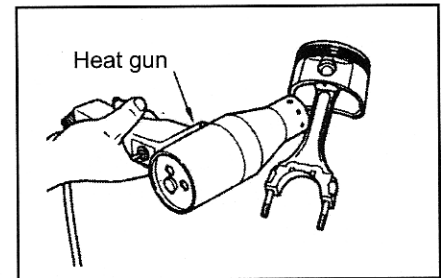

(4) Install the snap ring to the piston front side.

- Refer to (1) for snap ring installation direction.
- After installation make sure the conrod move smoothly.

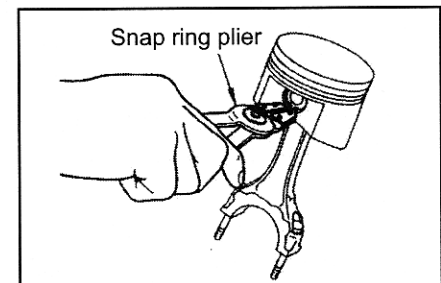

7. Use the piston ring expander to install the piston ring.

Caution:

Care must be taken not to damage the piston.

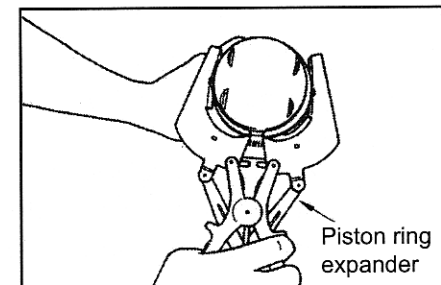

- Install in a way so the engraved mark on the top and the second ring alignment area will face the top.

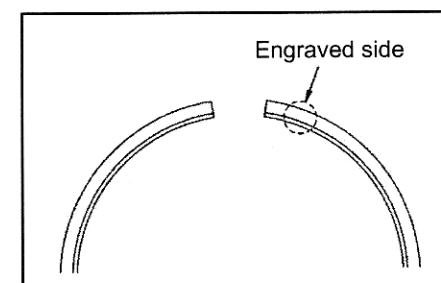

- Position the alignment mark as shown in the figure.

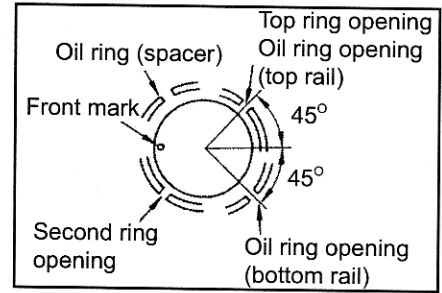

- Install the conrod and the conrod bearing to the conrod cap.
 - Coat the bearing surface (inner) with engine oil when installing the conrod bearing. Clean the reverse side sufficiently.
 - Align the conrod bearing projection and the conrod rotation stopper groove to install.
 - Make sure the conrod main body oil hole and the bearing oil hole position is correct.

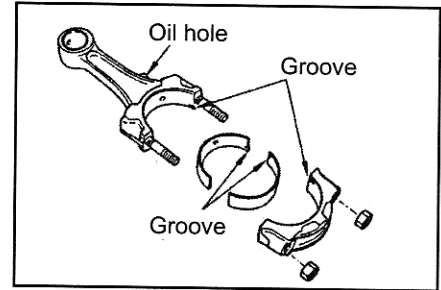

- Install the piston and conrod ASSY to the crankshaft.
 - Position the crank pin to B.D.C (bottom dead centre).
 - Apply plenty of engine oil to the cylinder bore, the piston and the crank pin.
 - Check the cylinder position and the conrod cylinder number.
 - Face the piston front mark towards the engine front and use the piston ring compressor to install.

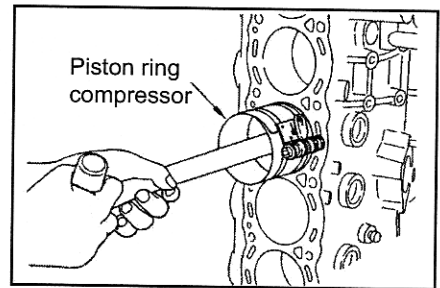

- Position the conrod in an angle of approx. 10~20° as shown in the figure, so it will not hit the oil jet when inserted.

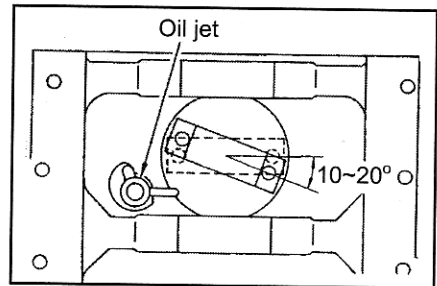

10. Install the conrod cap.

- Make sure the conrod and the cap cylinder No. is on the same side when installing.

(2) Tighten the conrod nuts in the following order.

- Apply engine oil to the conrod bolts and nuts bearing surface.
- Tighten to 14~16N0m{1.4~1.6kg-m}.
- Place alignment marks to the nuts and the conrod cap (eg white paint etc) in one direction (if using the protractor).
- Additionally tighten 60 ~ 65°.

Caution:

Make sure to use the angle wrench or the protractor to tighten. Never estimate visually.

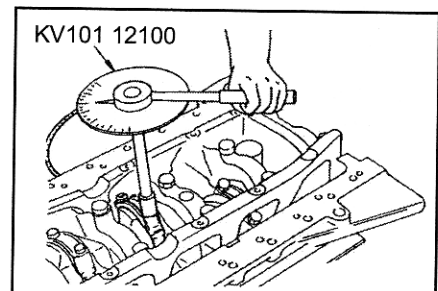

RB26DETT ENGINE

11. Install the rear oil seal.

- (1) Apply engine oil or chassis grease to oil seal lip circumference.
- (2) Use the oil seal drift to tap in the oil seal to level with the oil seal retainer front surface. Care must be taken not to cause any damage to the oil seal circumference.

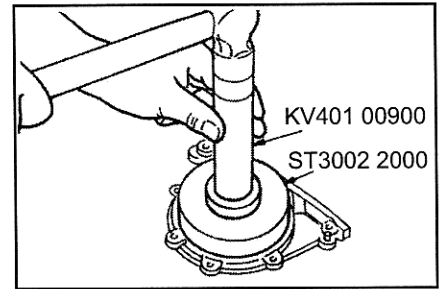

12. Install the rear oil seal retainer.

- (1) Use the scraper to remove liquid gasket.
- (2) Apply sealing agent (KP710 00150) to the rear oil seal retainer at approx. $\Phi 2.0 \sim 3.0$ mm.

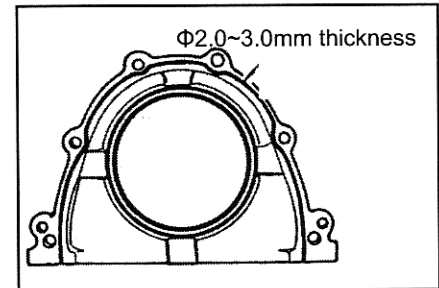

13. Align the rear oil seal retainer to the dowel pin to install.

Tightening torque (N-m{kg-m}) 6.3~8.3{0.64~0.85}

14. Install the baffle plate to the main bearing cap.

Tightening torque (N-m{kg-m}) 16~21{1.6~2.1}

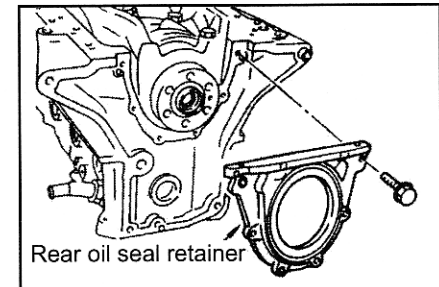

15. Install the pilot bush.

- Face the chamfered side towards the crankshaft and tap the pilot bush in until it hits the end.

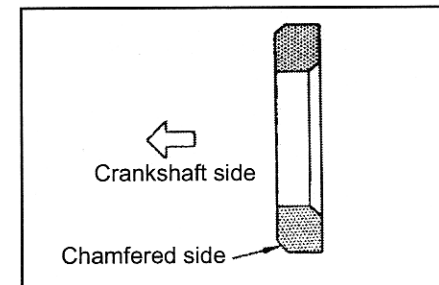

16. Install the fly-wheel.

- Use a ring gear stopper to fix the fly-wheel to tighten the installation bolts.
- Apply engine oil to the installation bolts thread and the bearing surface.
- Tighten the bolts in several stages in opposing angle.

Tightening torque (N-m{kg-m}) 142~152{14.5~15.5}

17. Install two knock sensors.

- Make sure there are no foreign objects on the cylinder block installation surface and the knock sensor rear surface.

Tightening torque (N-m{kg-m}) 16~21{1.6~2.1}

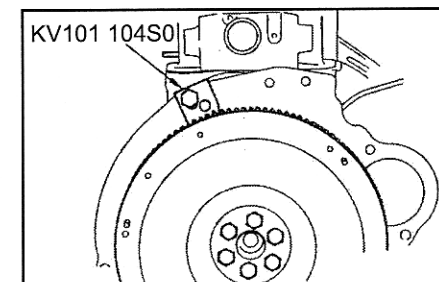

RB26DETT ENGINE

14. OIL PUMP

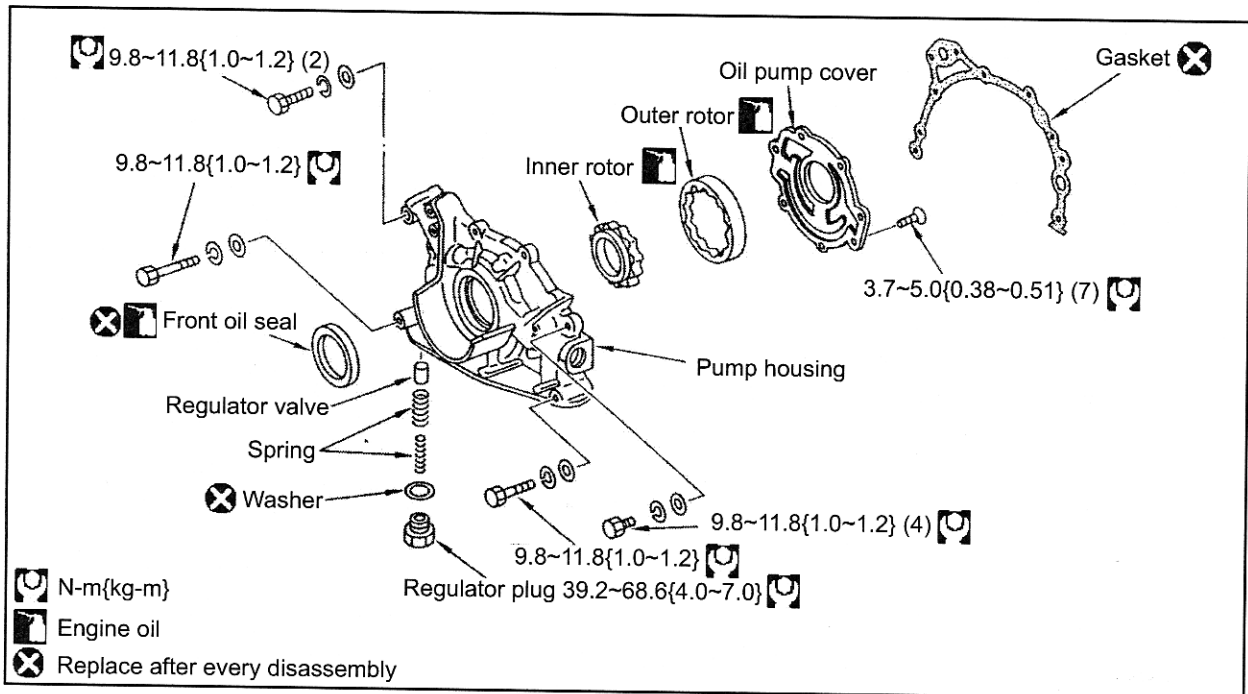
**Removal**

1. Remove the engine transmission ASSY.
2. Remove the transmission from the engine and attach it to the engine stand.
3. Drain the engine oil from the oil pan.
4. Remove the cooling fan.
5. Remove auxiliary belt.
6. Remove the timing belt.
7. Remove the crank timing pulley.
8. Remove the timing belt rear cover.
9. Remove the oil pan.
10. Remove the oil filter.
11. Remove the oil pump ASSY.

Installation

1. Install the inner rotor and the outer rotor.
 - Apply engine oil to each rotational parts.
 - Face the inner rotor groove side towards the cover to install.

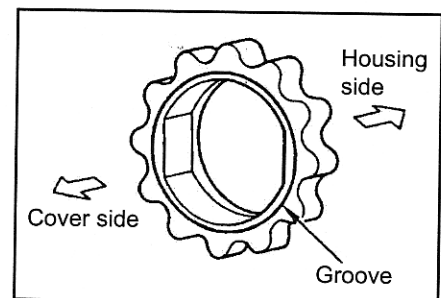

RB26DETT ENGINE

2. Equally tighten oil pump cover installation screw.
Tightening torque (N-m{kg-m}) 3.7~5.0{0.37~0.51}

3. Install the regulator valve.
 - Apply engine oil to rotational parts.
 - Replace the regulator washer with a new one.
 - Tighten the regulator plug.
Tightening torque (N-m{kg-m}) 39~69{4.0~7.0}

4. Install the front oil seal.
 - Replace the oil seal with a new one.
 - Make sure there is no damage to the oil seal circumference.
 - Position the oil seal next to the front side.
 - Use the oil seal drift to insert the oil seal to level with the oil pump oil seal installation surface.
 - Apply engine oil or the chassis grease to oil seal lip circumference.

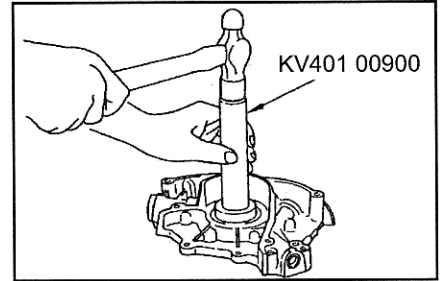
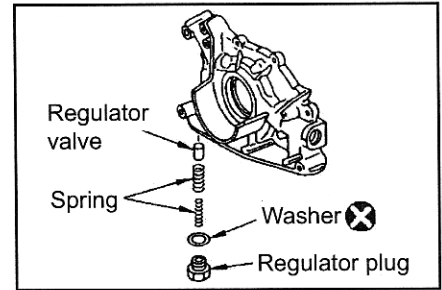

15. OIL FILTER BRACKET & WATER-COOLED OIL COOLER

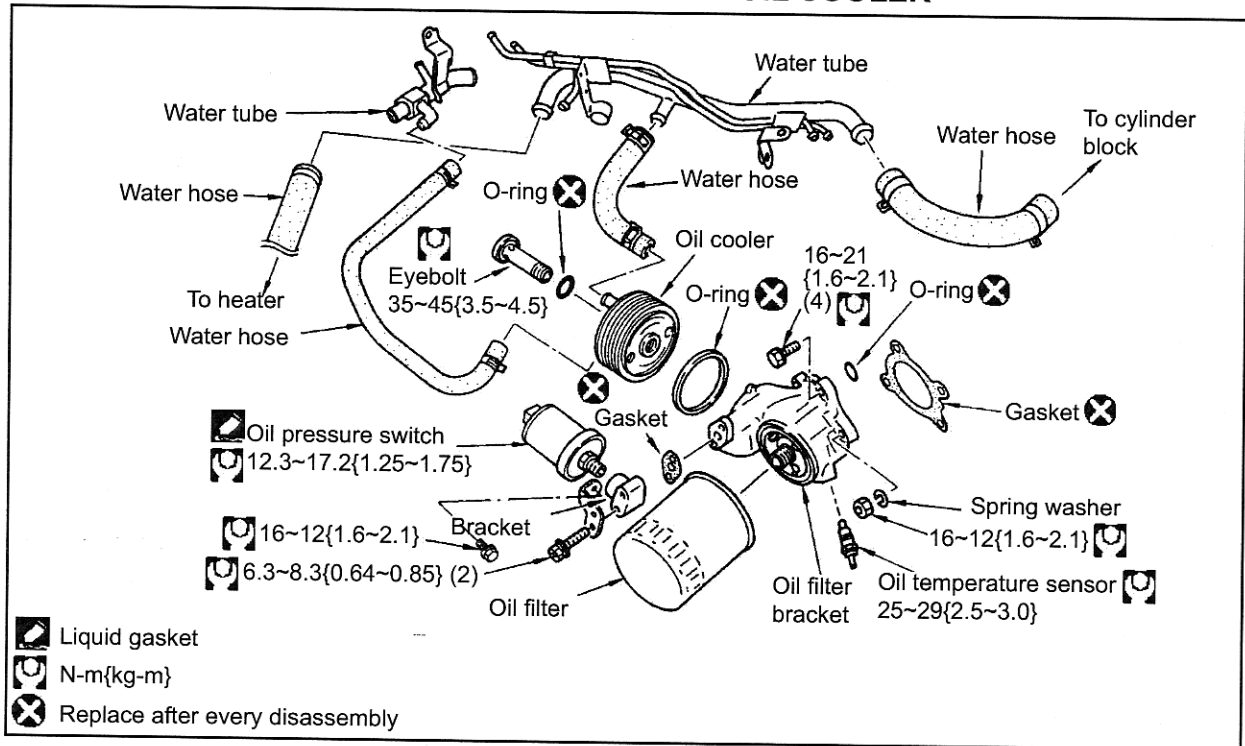

Removal

1. Remove the battery negative terminal inside the boot.
2. Remove the under cover.
3. Drain coolant from the radiator drain plug.
4. Drain coolant from the cylinder drain plug.
5. To create working space remove the following:
 - Strut tower bar
 - Accelerator cable
 - Accelerator cable bracket.
6. To create working space move the following:
 - Fuel filter and fuel filter bracket.
 - Main harness (between the starter motor and the relay case)
7. Remove the oil filter.
8. Remove the oil pressure switch connector and oil temperature sensor connector.
9. Remove two water hoses on oil cooler side.
10. Remove the oil filter bracket and oil cooler ASSY.
11. Remove the gasket.

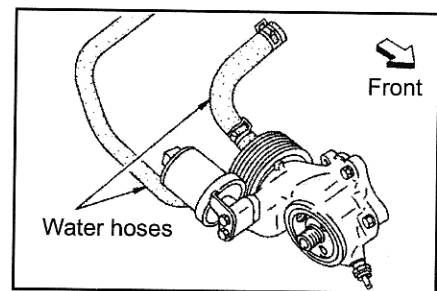

Installation

1. Install the oil filter bracket and oil cooler ASSY.
 - Replace the gasket with a new one.
 - Replace the o-ring with a new one.Tightening torque (N-m{kg-m}) 16~21{1.6~2.1}
2. Install two water hoses.
 - Tighten the clamps securely.
3. Install the oil filter.
4. Install the rest in reverse order to the removal procedure.
5. Check the engine oil and coolant level.
6. Start the engine and check for any engine oil or coolant leaks.
7. Cool the engine and recheck the engine oil and coolant level. Top up if the level has decreased.

Disassembly

1. Remove the oil pressure switch.
2. Remove the oil temperature sensor.
3. Remove the oil cooler from the oil filter bracket.
 - Place alignment marks on the oil filter bracket and the oil cooler before removal.

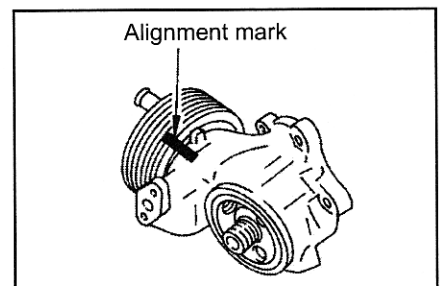

Inspection

Oil filter bracket visual inspection

- Check for oil leak due to any damage.
- Replace the oil filter bracket with a new one if there is any abnormality or faults.

Oil cooler inspection

- Check for any blockages in the oil cooler.
- Replace the oil cooler with new one if there is any abnormality or faults.

Assembly

1. Install the oil cooler to the oil filter bracket.
 - Replace the o-ring with a new one.
 - Align the oil cooler and the oil filter bracket alignment mark and tighten the eyebolts.Tightening torque (N-m{kg-m}) 34~44{3.5~4.5}
2. Install the oil pressure switch and the oil temperature sensor.
 - Apply sealing agent (KP710 00150) to the thread part.Tightening torque (N-m{kg-m})

Oil pressure switch	12.3~17.2{1.25~1.75}
Oil temperature sensor	25~29{2.5~3.0}

OIL FILTER BRACKET (N1 vehicle)

Removal

1. Remove the battery negative terminal inside the boot.
2. Remove the under cover.
3. To create working space remove the following:
 - Strut tower bar.
 - Accelerator cable.
 - Accelerator cable bracket.
4. To create working space move the following:
 - Fuel filter and fuel filter bracket.
 - Main harness (between the starter motor and the relay case).
5. Remove the oil filter.
6. Remove the oil pressure switch connector and oil temperature sensor connector.
7. Remove two oil tubes from the oil filter bracket.
8. Remove the oil filter bracket.
9. Remove the gasket.
10. Remove the oil pressure switch and the oil temperature sensor from the oil filter bracket.

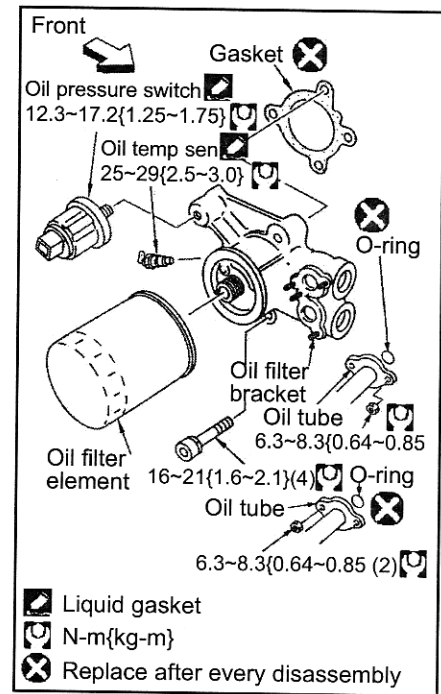

Inspection

Oil filter bracket visual inspection

- Check for oil leaks due to any damage.
- Replace the oil filter bracket with a new one if there is any abnormality or faults.

Installation

1. Install the oil pressure switch and the oil temperature sensor.
 - Apply sealing agent (KP710 00150) to thread part.

Tightening torque (N-m{kg-m})

Oil pressure switch	12.3~17.2{1.25~1.75}
Oil temperature sensor	25~29{2.5~3.0}
2. Install the oil filter bracket.
 - Replace the gasket and the o-ring with a new one.

Tightening torque (N-m{kg-m}) 16~21{1.6~2.1}
3. Install two oil tubes.

Tightening torque (N-m{kg-m}) 6.3~8.3{0.63~0.85}
4. Connect the oil pressure switch connector and the oil temperature sensor connector.
5. Install the oil filter.
6. Install the rest in reverse order to the removal procedure.
7. Check the level of engine oil and look for any oil leaks.

RB26DETT ENGINE

16. AIR-COOLED OIL COOLER (N1 vehicle)

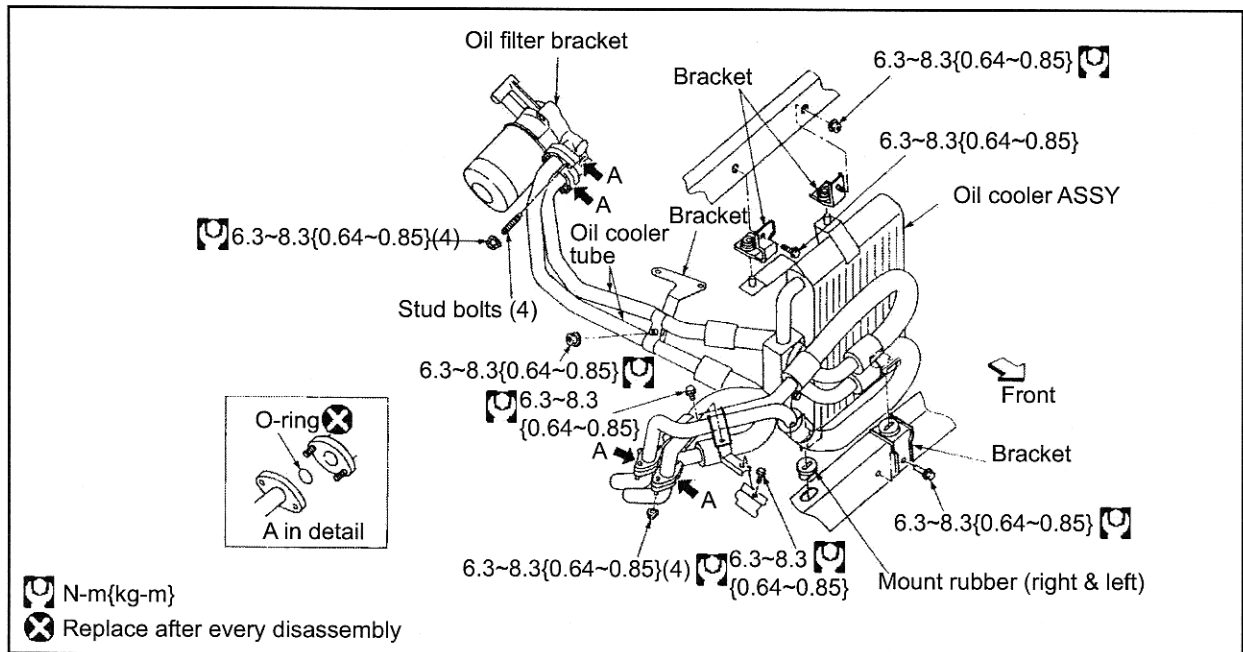
**Removal**

1. Remove the battery negative terminal inside the boot.
2. Remove the front spoiler under cover.
3. Remove the under cover.
4. Drain coolant from the radiator drain plug.
5. Remove the radiator.
6. Remove the oil tube at oil cooler side.
 - Place a hole cap on the oil tube side and the oil cooler side.
7. Remove right and left oil cooler mount bracket (upper) installation bolts and nuts.
8. Remove the oil cooler from the engine bay side.

Caution:

Care must be taken not to damage the oil cooler core.

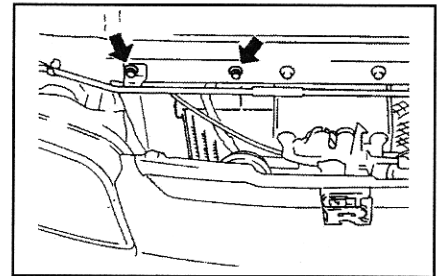
**Inspection****Oil cooler visual inspection**

- Make sure there is no damage or abnormality with the oil cooler core.
- Replace the oil cooler if there is any fault.

Oil hose visual inspection

- Check the oil hose for any cut or damage.
- Replace the oil hose if there is any fault.

RB26DETT ENGINE

Installation

1. Install the oil cooler.
 - (1) Install the mount bracket (upper) to the oil cooler.
 - (2) Install the oil cooler from engine bay side.
 - Make sure to insert the grommet into the installation hole securely.
 - (3) Tighten the mount bracket (upper) installation bolts and nuts.

Tightening torque (N-m{kg-m}) 6.3~8.3{0.64~0.85}

Caution:

Care must be taken not to damage the oil cooler core parts.

2. Connect the oil tube.
 - Replace the o-ring with a new one.Tightening torque (N-m{kg-m}) 6.3~8.3{0.64~0.85}
3. Install the rest in reverse order to the removal procedure.
4. Check the level of engine oil.
5. Start the engine and check for any engine oil leak.
6. After cooling down the engine, recheck the level of engine oil and top up if necessary.

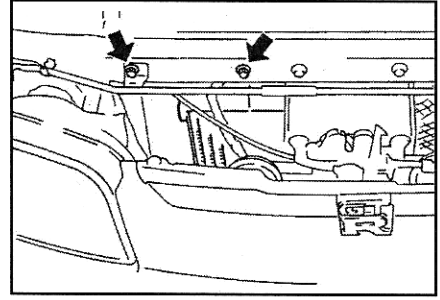

RB26DETT ENGINE

17. RADIATOR

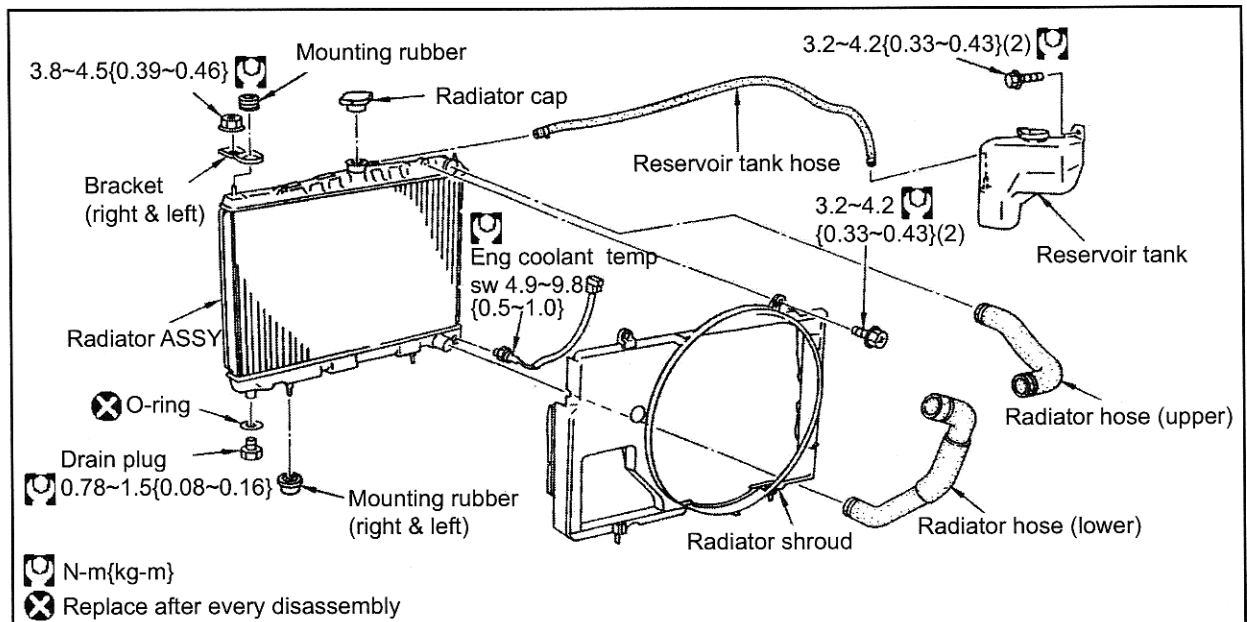
**Removal**

1. Remove the battery negative terminal inside the boot.
2. Drain coolant from the radiator drain plug.
3. Remove the air duct.
4. Remove the reservoir tank hose at radiator side.
5. Remove the radiator upper hose and lower hose.

Caution:

Care must be taken not to get coolant on the alternator electrical components.

6. Remove the engine coolant temperature switch harness connector.
7. Remove right and left radiator upper mount bracket.
8. Remove the fan shroud installation bolts and move the fan shroud towards the cooling fan.
9. Remove the radiator ASSY.
 - Care must be taken not to damage the radiator core.
10. Remove the fan shroud.
11. Remove the engine coolant temperature switch from the radiator.

Installation

1. Install the engine coolant temperature switch to the radiator.

Tightening torque (N-m{kg-m}) 4.9~9.8{0.5~1.0}
2. Place the shroud on the cooling fan temporarily.
3. Install the radiator ASSY.
 - Care must be taken not to damage the radiator core.

RB26DETT ENGINE

4. Install the right and left radiator upper mount bracket.
Tightening torque (N-m{kg-m}) 3.8~4.5{0.39~0.46}
5. Install the engine coolant temperature switch harness connector.
6. Install the radiator shroud.
Tightening torque (N-m{kg-m}) 3.2~4.2{0.33~0.43}
 - Care must be taken not to damage the radiator core.
 - Only use genuine shroud installation bolts.
7. Install the radiator hose.
 - Position the radiator hose so the hose end alignment mark is as shown.
 - Tighten the clamp to specified torque.
Tightening torque (N-m{kg-m}) 2.0~2.2{0.20~0.22}
8. Install the rest in reverse order to the removal procedure.

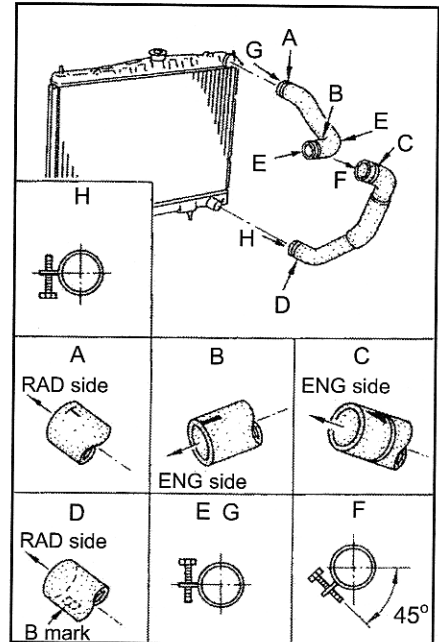
**Inspection**

- Check the coolant level and top up if necessary.
- Start the engine and check for any coolant leaks.

RB26DETT ENGINE

18. COOLING FAN**Removal**

1. Remove the battery negative terminal inside the boot.
2. Remove the air duct.
3. Loosen the cooling fan installation nuts.
4. Loosen the fan belt.
5. Remove the installation nuts to remove the cooling fan.
6. Remove the installation bolts to remove the fan from the cup ring.

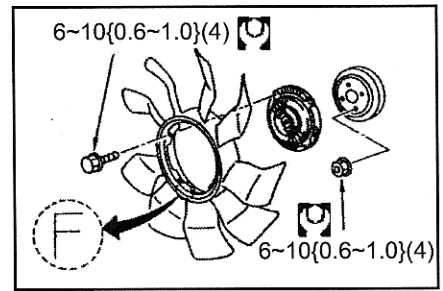
**Inspection****Cup ring inspection**

- Check for any silicon oil leak.

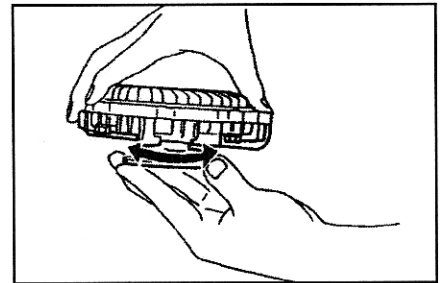
**Cooling fan inspection**

- Check for any damage or cut.

Installation

Install the parts in reverse order to the removal procedure.

- Install the fan to the cup ring making sure the front mark is facing front.
Tightening torque (N-m{kg-m}) 6~10{0.6~1.0}
- Adjust the fan belt tension.

19. AUXILIARY MOTOR FAN**Removal**

1. Remove the battery negative terminal inside the boot.
2. Remove the front spoiler under cover (N1 vehicle).
3. Remove the under cover.
4. Remove the hood support stay.
5. Remove the left side horn bracket ASSY.

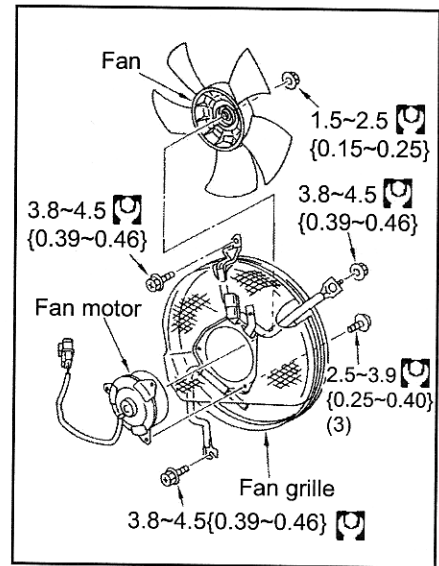

6. Remove the hood lock stay installation bolts and move the hood lock stay to the right side of the vehicle.
7. Disconnect the auxiliary motor fan harness connector.
8. Remove the installation bolts (top and bottom) and the installation nuts to remove auxiliary motor fan.

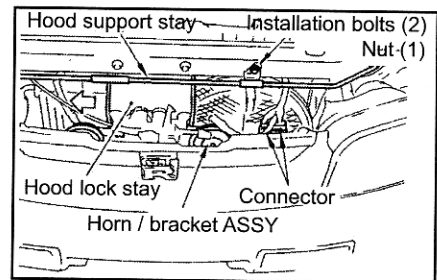
**Caution:**

Care must be taken not to damage the air conditioner condenser.

9. Remove the fan from the fan motor.
10. Remove the fan motor from the fan grille.

Installation

1. Install the fan motor to the fan grille.
Tightening torque (N·m{kg·m}) 2.5~3.9{0.25~0.40}
2. Install the fan to the fan motor.
Tightening torque (N·m{kg·m}) 1.5~2.5{0.15~0.25}
3. Install the auxiliary motor fan.

Caution:

Care must be taken not to damage the air conditioner condenser.

4. Install the auxiliary motor fan harness connector.
5. Install the rest in reverse order to the removal procedure.

20. WATER PUMP

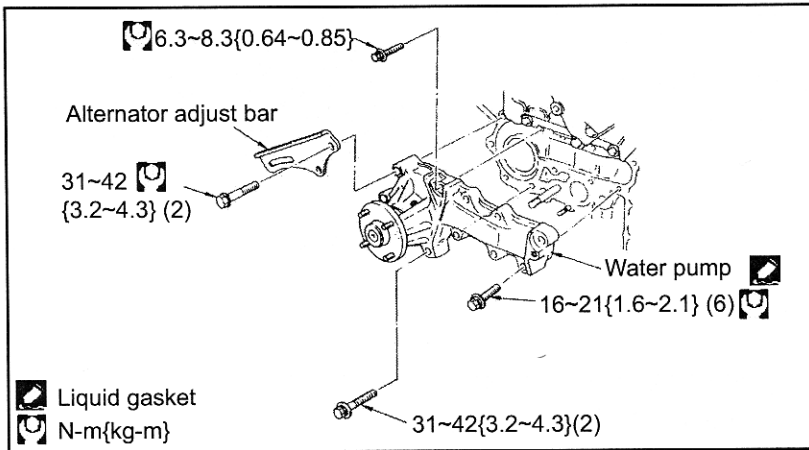

Removal

1. Remove the battery negative terminal inside the boot.
2. Remove the air duct.
3. Remove the front spoiler under cover (N1 vehicle).
4. Remove the under cover.
5. Drain coolant from the radiator drain plug.
6. Drain coolant from the cylinder block drain plug.
7. Remove the cooling fan.
8. Remove the radiator.
9. Remove the auxiliary belt.
10. Remove the water pump pulley.
11. Remove the timing belt.
12. Remove the tensioner pulley.
13. Remove the tensioner pulley and the idler pulley.
14. Remove the alternator adjust bar.
15. Remove the installation bolts in the order shown.
16. Remove the water pump.

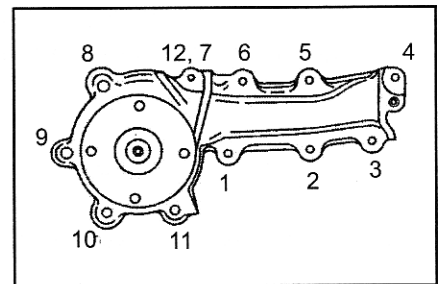

- Insert a stubby driver into the installation bolt hole and move it up and down to remove.

Caution:

Care must be taken not to damage the cylinder block side screws.

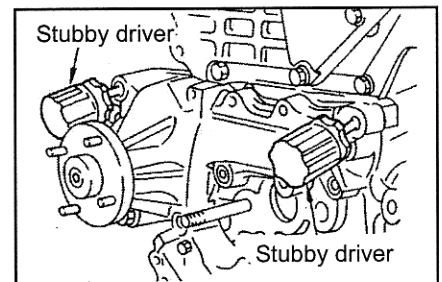

RB26DETT ENGINE

Inspection

- Check the water pump main body and the vane for rust or foreign objects.
- Make sure the water pump is not wobbly.
- Replace the water pump if there is any abnormality.

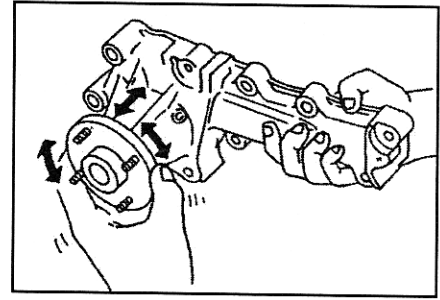
**Installation**

1. Install the water pump.
- Use a scraper to remove old gasket from the water pump and the cylinder block installation surface.
 - Clean the installation surface with white gasoline.
 - Apply sealing agent (KP710 00150) to the position shown in approx. $\Phi 2.0\sim 3.0\text{mm}$.
2. Tighten the installation bolts in the order shown.
 3. Tighten the installation bolts 4 and 5 together with the alternator adjust bar.

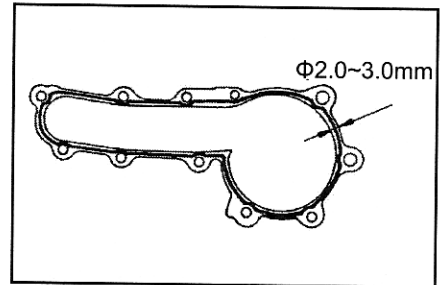
**Reference:**

No. 1 and 6 refers to retightening the same bolt twice.

- The bolt measurements are different depending on the installation position.

M6 bolt:	No.1
M8 bolt:	No. 7, 8, 9, 10, 11, 12
M10 bolt (short)	No. 2, 3
M10 bolt (long)	No. 4, 5

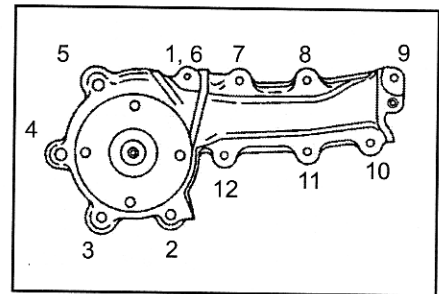

- There are three types of installation bolts.

Tightening torque (N-m{kg-m})

M6	6.3~8.3{0.64~0.85}
M8	16~21{1.6~2.1}
M10	31.4~42.1{3.2~4.3}

2. Install the rest in reverse order to the removal procedure.
3. Check the coolant level.
4. Start the engine and check for any coolant leaks.
5. After cooling down the engine recheck the coolant level and top up if necessary.

21. ACCELERATOR CONTROL SYSTEM

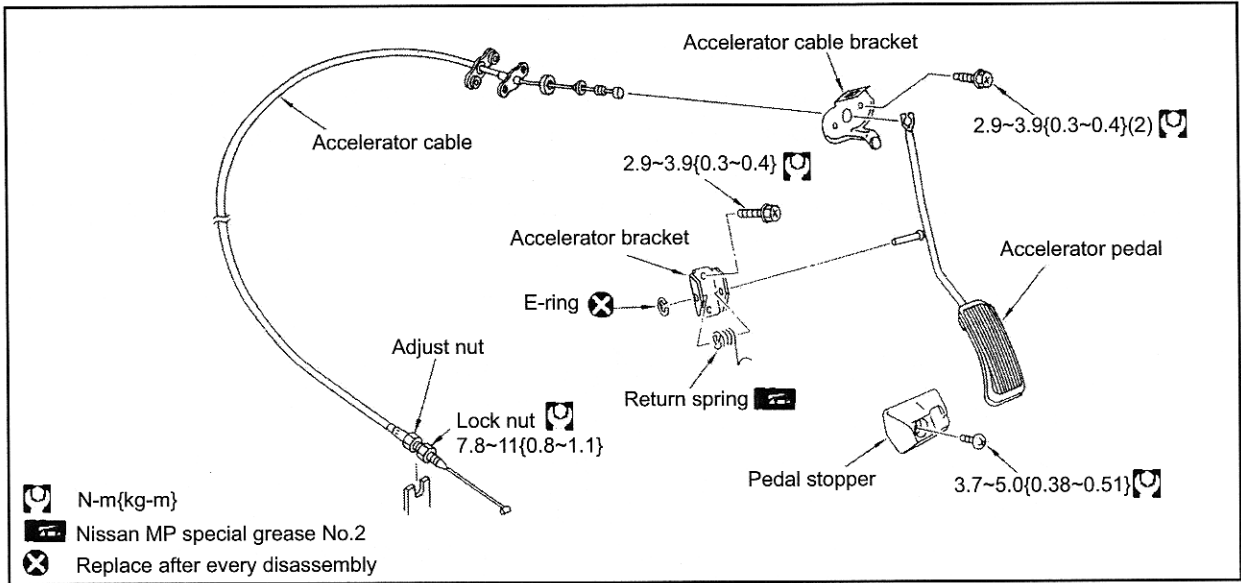

Removal

1. Remove the accelerator cable outer case from the accelerator cable bracket.
2. Disconnect the accelerator cable at throttle drum side.
3. Disconnect the accelerator cable at accelerator pedal side.
4. Remove the accelerator pedal bracket installation bolts to remove the accelerator pedal / bracket ASSY.

Installation

Installation is the reverse order of the removal procedure.

- Apply Nissan MP special grease No. 2 to the return spring.
- Replace E-ring with a new one.

Caution:

- Do not position the switch to fully open stopper.
- Do not damage or bend the wire.

Inspection

- Make sure the throttle drum side is fully open when the accelerator pedal is depressed fully.
- Make sure it move smoothly.

Adjustment

- Loosen the wire and adjust the adjust nut to pull the outer case towards the accelerator pedal until the throttle drum starts to move.

From this position turn back the adjust nut 1.5 ~ 2.0 turns, and secure the lock nut.

Tightening torque (N-m{kg-m}) 7.8~11{0.8~1.1}

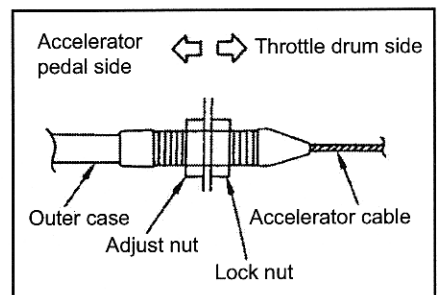

22. FUEL TANK

Caution:

- Check the fuel tube is secured properly to the vehicle body with a clip. Make sure there are no fuel leaks, damaged or rusty tubes. Replace parts if there is any abnormality.
- Check to make sure the evaporator system tubes are connected properly after installation.
- Check the clips for cracks and make sure they are not coming off. Replace the parts if there is any abnormality or faults.

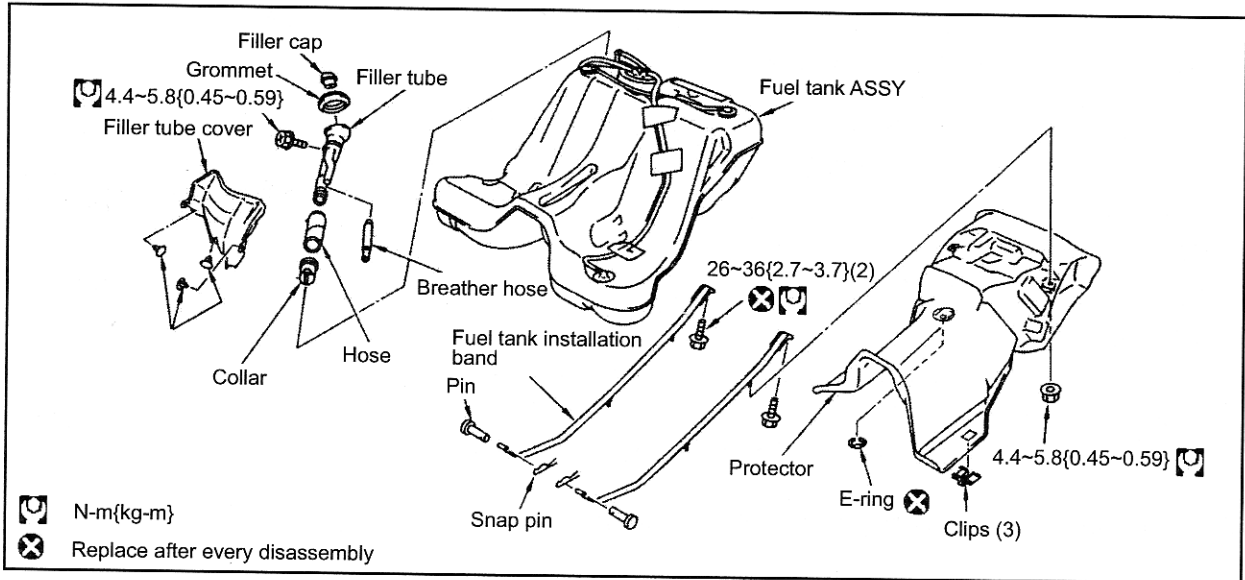

Removal

1. Open the boot lid.
2. Remove the boot front finisher.
3. Remove the strut tower bar.
4. Remove the rear floor board.
5. Release fuel pressure from the fuel line.

Releasing fuel pressure

 - Start the engine.
 - Select the "Fuel pressure release" in "Work support" mode with CONSULT.
 - Select "Start" and after engine stalls crank it 2 to 3 times.
 - For the vehicles that are unable to start, crank 3 to 4 times.

After restarting the engine, remove the fuel pump fuse and run the engine until it stalls. Crank 2 to 3 times to consume fuel left in the fuel pipes.
6. Remove the negative battery terminal.
7. Open the fuel filler lid.
8. Remove the rear speaker amp and rear speaker amp bracket.

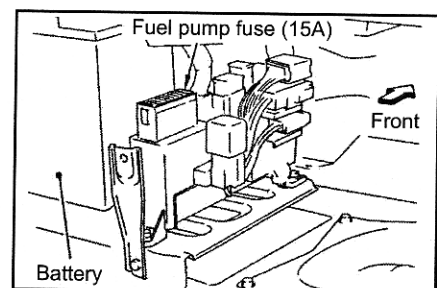
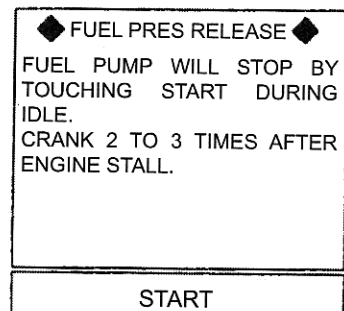

RB26DETT ENGINE

9. Open the inspection hole cover and remove the connector from the fuel sender unit.

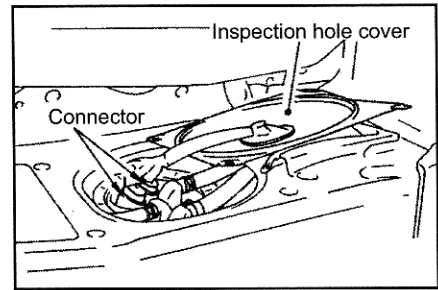

10. Extract the fuel inside the fuel tank by removing the filler opening or the fuel sender unit.

Caution:

Keep open flames and sparks away from work area.

- 11. Remove exhaust centre tube and main muffler.
- 12. Remove the drive shaft.
- 13. Remove the rear suspension member ASSY.
- 14. Remove the park brake wire, differential breather hose and ABS sensor harness.
- 15. Remove the filler tube cover.

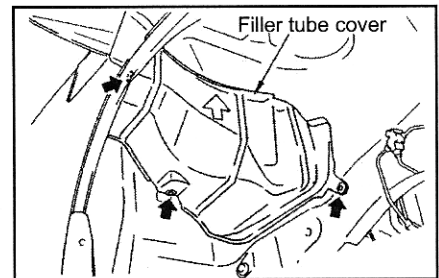

16. Remove the filler tube.

- Loosen two clamps to remove the hose and then remove installation bolts to pull out the filler tube from the grommet on the filler opening side.

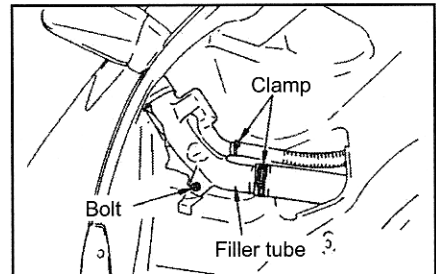

17. Remove the fuel hose on the right side of the fuel tank.

- Place an alignment mark on the fuel hose to avoid confusion.

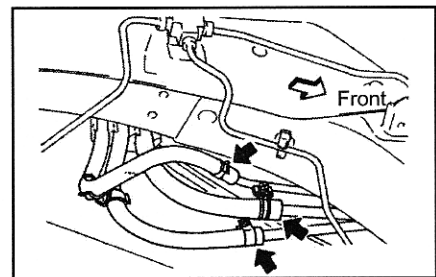

18. Use transmission jack to support bottom of the fuel tank.

- Place a caul etc. under the fuel tank to support securely.

Reference:

When it is necessary to remove the fuel tank protector, remove it before using the transmission jack to support the fuel tank.

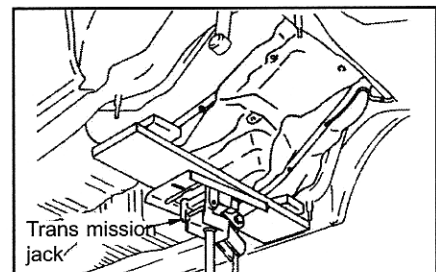

RB26DETT ENGINE

19. Remove two fuel tank installation band pins at the front and two band pins at the rear.
20. Remove the fuel tank by lowering the transmission jack supporting the fuel tank.

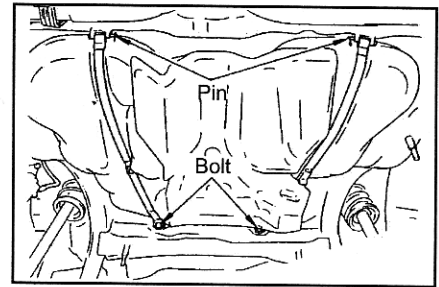

21. Remove the fuel check valve.
 - Remove two hoses and the clip on the bracket.

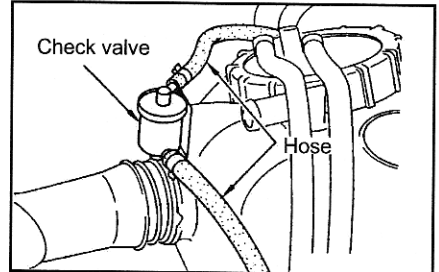

Inspection

Fuel tank visual inspection

- Look for any cuts or wear.
- Replace the fuel tank if there is any abnormality.

Fuel hose visual inspection

- Look for any cuts or wear.
- Replace the fuel tank if there is any abnormality.

Installation

1. Install the fuel check valve.
 - Position the side with printing on the top.
 - Insert the hose until it touches the end then securely fix the clamp.

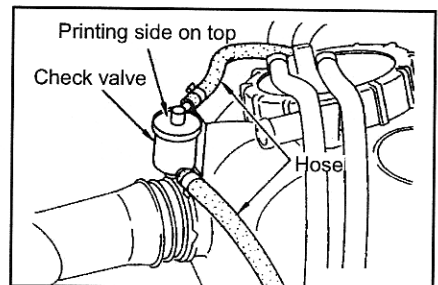

2. When installing the fuel tank filler opening collar position as shown in the figure.
3. Install each fuel hose.
 - Connect each hose securely.
 - Place the clamps making sure it will not touch the bulged area.

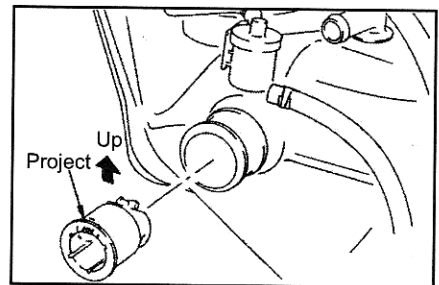

4. Use the transmission jack to support the bottom and install the fuel tank ASSY at installation position.
 - Hold the filler hose and the vent hose with hands until it is inserted into the hole on the vehicle body so it will not interfere with the vehicle body.

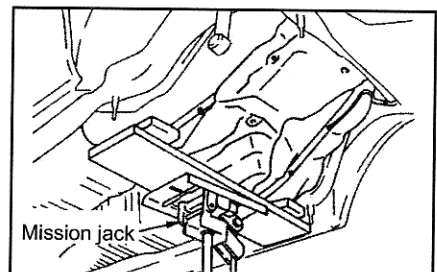

RB26DETT ENGINE

5. Install the fuel tank installation band.
 - Identification point (R) is located on the reverse side of the band (on the tank side).
 - Insert front pin from outside to inside and make sure to attach the fixing pin.
 - Replace the rear side installation bolts with new ones.

Tightening torque (N-m{kg-m}) 26~36{2.7~3.7}
6. Install the fuel tank protector.

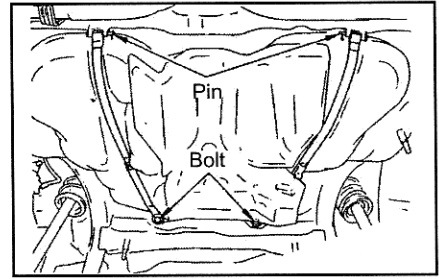

7. Connect the fuel hose to the right side of the fuel tank.
 - Align to the alignment mark that you have placed at the removal.
 - Fix the clamp securely avoiding the bulged area.

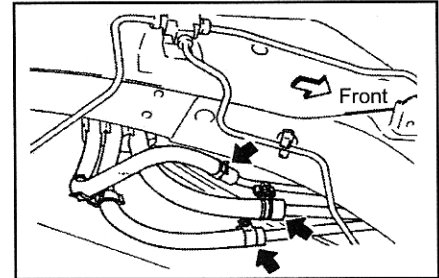

8. Install the filler tube.
 - Align the projection on the grommet on the filler opening side to the groove on the filler tube to install.

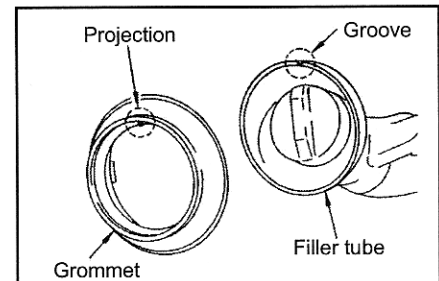

- Connect hoses securely.
- Fix the clamp securely avoiding the bulged area.

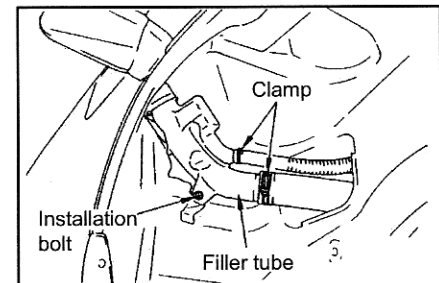

9. Attach the filler tube cover.
 - Position the arrow on the top.

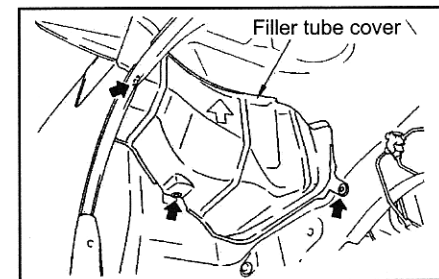

10. Connect the fuel sender unit connector.

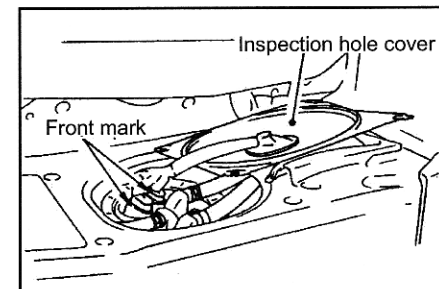

RB26DETT ENGINE

11. Install the inspection hole cover.
 - Position so the arrow will face the front.
12. Install the rest in reverse order to the removal procedure.



Inspection

- Make sure each clamp is closed securely.
- Place the ignition switch to ON position. Check for any fuel leaks when the fuel pressure is applied to the fuel lines.

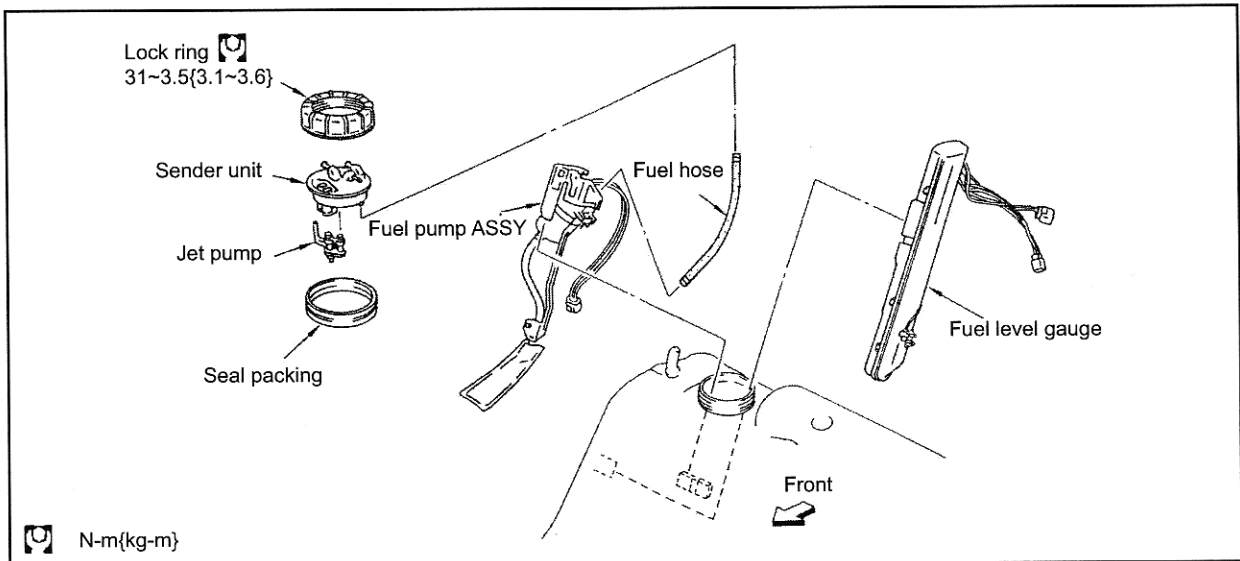
23. FUEL PUMP & FUEL GAUGE



Removal

1. Open the boot lid.
 2. Remove the boot front finisher.
 3. Remove the strut tower bar.
 4. Remove the rear floor board.
 5. Release fuel pressure from the fuel line. 
- Releasing fuel pressure
- Start the engine.
 - Select the "Fuel pressure release" in "Work support" mode with CONSULT.
 - Select "Start" and after engine stalls crank it 2 to 3 times.
 - For the vehicles that are unable to start, crank 3 to 4 times.
- After restarting the engine, remove the fuel pump fuse and run the engine until it stalls.  Crank 2 to 3 times to consume fuel left in the fuel pipes.
6. Remove the negative battery terminal.
 7. Open the fuel filler lid.
 8. Fully open the filler cap and release the fuel tank inner pressure.
 9. Remove the rear speaker amp and rear speaker amp bracket.
 10. Open inspection hole cover and remove the fuel hose and the fuel sender unit connector.
- Place alignment mark to avoid confusion at installation.

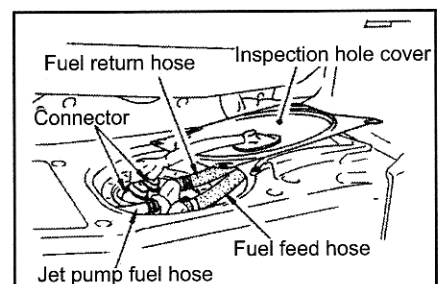

RB26DETT ENGINE

11. Use the lock ring wrench to remove the lock wrench.

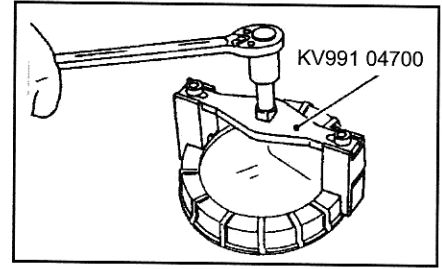

12. Lift up the fuel sender unit to remove the connector and the fuel hose.

13. Extract fuel remaining in the tank.

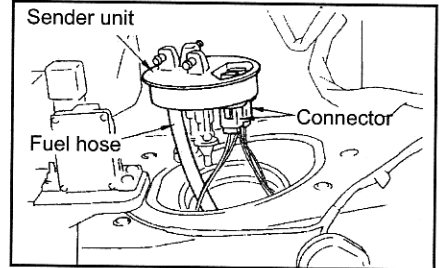

14. Remove the fuel pump.

- Slide the fuel pump upwards to remove.

15. Remove the fuel level gauge.

(1) Slide the fuel level gauge towards the left side of the vehicle and bring it to the fuel tank opening to remove.

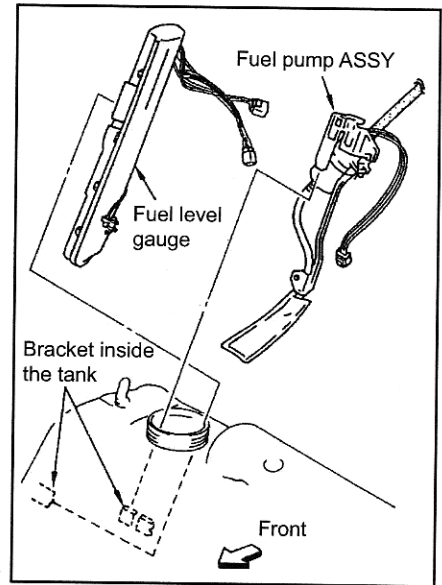

(2) Disconnect the connector and remove the fuel level gauge.

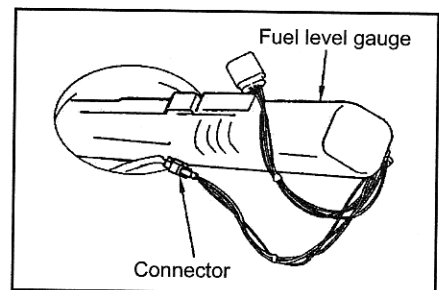

RB26DETT ENGINE

Installation

Install the parts in reverse order to the removal procedure taking note of the following points:

- Connect the fuel hose and the connectors securely.
- Make sure to connect the fuel pump wiring in the correct direction.
- Replace the seal packing with a new one.
- Position the fuel sender unit so the alignment mark will face three centre lines on the fuel tank.
- Use the lock ring wrench to tighten the lock ring.
Tightening torque (N-m{kg-m}) 30~35{3.1~3.6}
- Position the inspection cover so the arrow will face the front.

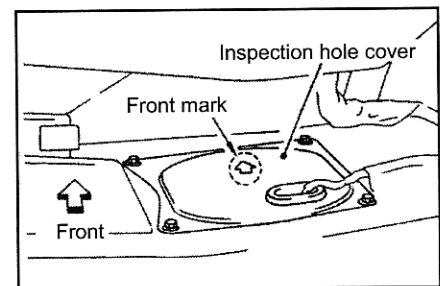
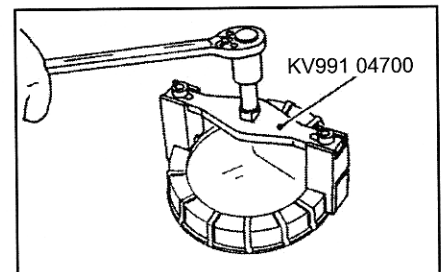
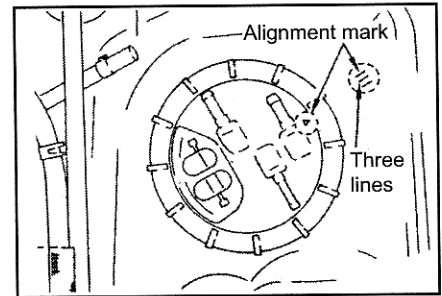

RB26DETT ENGINE

- Offset measurements when each mount rubber is installed correctly.

PARTS		X	Y	Z
Exhaust centre tube		0	5	43
Rear muffler front		0	5	43
Rear muffler rear	Right	38	0	29
	Left	38	0	29

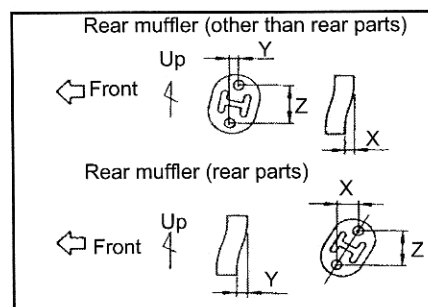

Inspection

- Start the engine and check for any gas leaks from each connection.
- Check for any exhaust gas leaks due to corrosion.
- Replace the parts with new one if there is gas leak due to corrosion.

EN4 ENGINE REMOVAL (RB20E)

Caution:

- Extra safety precautions must be taken and do not carry out unnecessary operation.
- Do not carry out any operations until the exhaust system has cooled down.
- Make sure the vehicle is supported in the correct position when lifting up the vehicle.

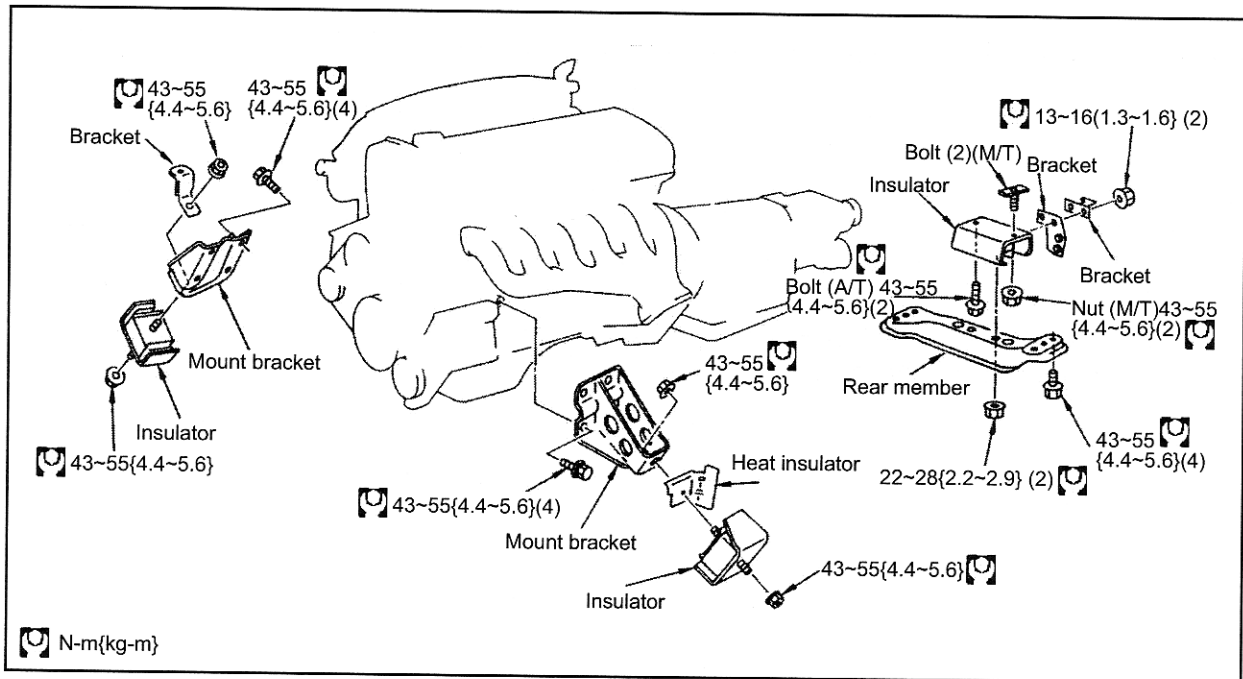

Removal

1. Release the fuel pressure.
 2. Remove the battery negative terminal.
 - (1) Open the boot lid.
 - (2) Remove the boot front finisher and remove the negative battery terminal.
 3. Remove the engine hood.
 4. Remove the under cover.
 5. Drain coolant from the radiator drain plug.
 6. Drain coolant from the cylinder block drain plug.
 7. Remove the air duct and the resonator ASSY.
 8. Disconnect the hose between the canister and the intake manifold collector at the intake manifold collector side.
 9. Remove the cooling fan.
 10. Remove the radiator.
 11. Remove the auxiliary belt.
- [Engine left]
12. Remove the exhaust sensor connector.
 13. Disconnect the exhaust manifold cover earth wire.
 14. Remove the power steering reservoir tank installation bolts and move it towards front side.
 15. Disconnect the air conditioner compressor connector.
 16. Remove the air conditioner compressor from the bracket and use a rope to fix it to the vehicle body side.

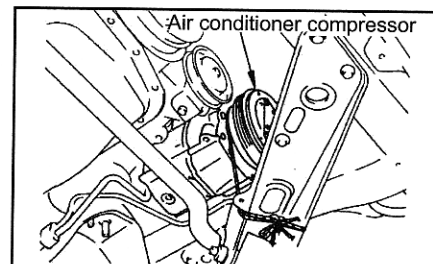

RB20E ENGINE

17. Remove the power steering pump from the bracket and use a rope to fix it to the vehicle body side.
18. Remove the power steering pump adjustment bar.

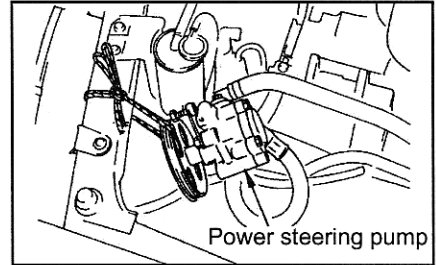

[Engine right]

19. Disconnect the engine coolant temperature sensor and thermal transmitter connectors.
20. Disconnect the intake manifold front side earth wire.
21. Disconnect the throttle sensor and throttle valve switch connectors.
22. Disconnect the injector harness connector at engine rear side.
23. Disconnect the ignition coil connector.
24. Disconnect the oil pressure sensor connector.
25. Disconnect the alternator wiring.
26. Disconnect the acceleration wire from the throttle drum.
27. Disconnect every connector that is connected to the engine side around the relay box area.

28. Disconnect the fuel feed and the return hose at the fuel tube side.

Caution:

Place a hole cap so the fuel will not leak.

29. Disconnect the brake booster vacuum hose at the intake manifold collector side.
30. Disconnect the heater hose.
- Place a hole cap to avoid coolant from leaking when the engine is lifted up and tilted.

[Lower engine]

31. Remove the exhaust front tube.
32. Remove the control lever ASSY. After the removal place a hole cap or seal shift rod installation area with taping to avoid wash out of transmission oil.
33. Remove the clutch operation cylinder.
34. Disconnect A / T control linkage.
35. Remove the drive shaft.
- Place a hole cap on rear area of the transmission to avoid transmission oil leakage when the engine is lifted up.

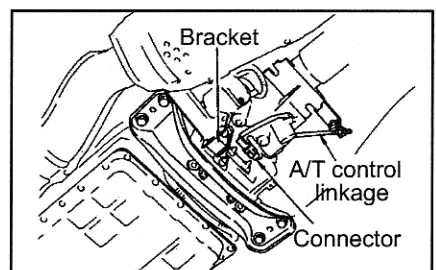

RB20E ENGINE

[Engine right & left]

36. Install engine sling to right side engine front and left side engine rear.

37. Place the chain block hook on to the engine sling and support it with hoist.

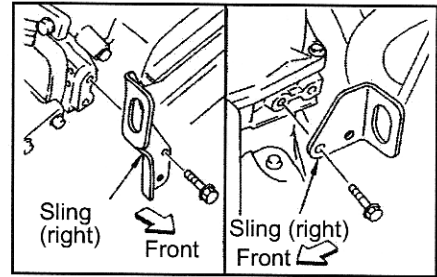

38. Remove right and left gasket.

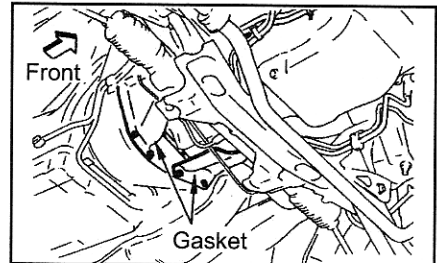

39. Support transmission with the transmission jack.

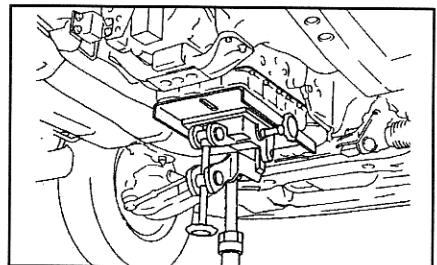

40. Remove front right and left engine mount installation nut.

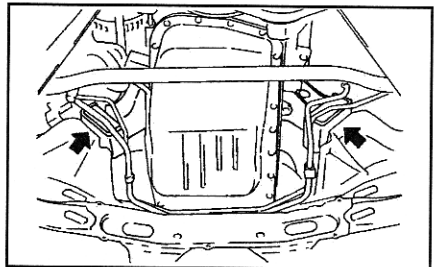

41. Remove rear member.

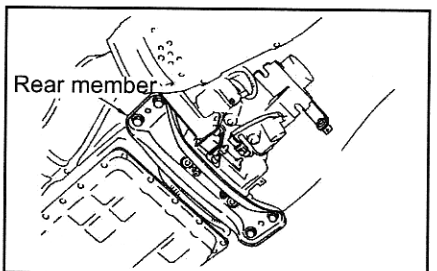

42. Lift up the engine and the transmission ASSY carefully by changing angle of the engine and the transmission frequently.

- Check to make sure you have not forgotten to remove or disconnect any pipes or wiring. Extra caution must be taken not to allow any parts to come in contact with the vehicle exterior, especially the front tip of the transmission and the oil tubes around the steering cylinder, crank pulley and the air conditioner condenser.

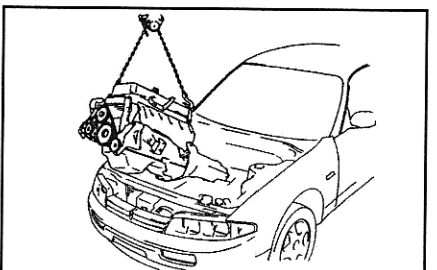

RB20E ENGINE

Installation

Install the parts in reverse order to the removal procedure.

- Tighten installation bolts and nuts making sure there are no problems with any of the mount insulators.
- Carry out the accelerator wire adjustment.
- Adjust auxiliary belt tension.
- Carry out idle inspection and adjustment.

Inspection

- Before starting the engine be sure to check the level of engine oil, coolant, power steering oil and A / T fluid oil. Top up if the level of any fluid is inadequate.
- Start the engine and check for any abnormal noise or movement from any parts.
- Warm up the engine sufficiently and check that coolant, engine oil, A / T fluid, fuel and exhaust gas are not leaking.

RB25DE / RB25DET ENGINE

ENGINE REMOVAL (RB25DE / RB25DET)**Caution:**

- Extra safety precautions must be taken and do not carry out unnecessary operation.
- Do not carry out any operation until the exhaust system has cooled down.
- Make sure the vehicle is supported in the correct position when lifting up the vehicle.

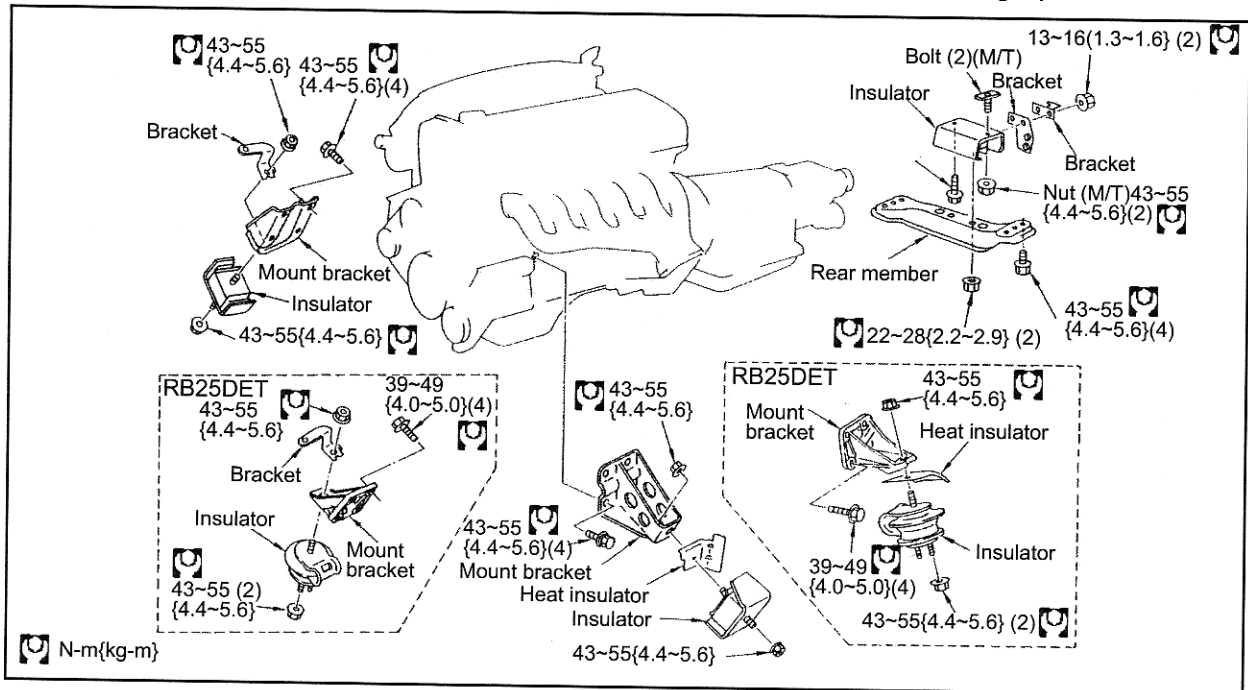
**Removal**

1. Release the fuel pressure.
2. Remove the battery negative terminal.
 - (1) Open the boot lid.
 - (2) Remove the boot front finisher and remove the negative battery terminal.
3. Remove the engine hood.
4. Remove the under cover.
5. Drain coolant from the radiator drain plug.
6. Drain coolant from the cylinder block drain plug.
7. Remove the air duct and the air cleaner case.
8. Remove the air duct and the air ASSY (RB25DE).
9. Disconnect the air inlet pipe and the air inlet hose (RB25DET).
10. Remove the canister hose.
11. Remove the cooling fan.
12. Remove the radiator.

RB25DE / RB25DET ENGINE

[Engine left]

13. Remove the exhaust sensor connector.
14. Disconnect the exhaust manifold cover earth wire.
15. Remove the power steering reservoir tank installation bolts and move it towards the front side.
16. Disconnect power transistor unit connector.
17. Disconnect the air conditioner compressor connector.
18. Remove the air conditioner compressor from the bracket and use rope etc. to fix it to the vehicle body.
19. Remove the power steering pump from the bracket and use rope etc. to fix it to the vehicle body.
20. Remove the power steering pump adjustment bar.

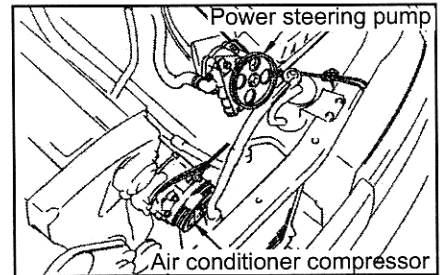

[Engine right]

21. Disconnect the engine coolant temperature sensor and thermal transmitter connectors.
22. Disconnect two intake manifold front side earth wire.
23. Disconnect the throttle sensor and the throttle valve switch connectors.
24. Disconnect the fuel injector harness connector at the centre.
25. Disconnect the VTC solenoid connector.
26. Disconnect the AAC valve and the FICD connector.
27. Disconnect the crank angle sensor connector.
28. Disconnect the power steering pipe pressure sensor connector.
29. Disconnect EPS solenoid connector. (Vehicle with super HICAS power steering vehicle)
30. Disconnect the engine earth wire.
31. Remove the acceleration wire and the ASCD wire (vehicle with ASCD) from the throttle drum.
32. Remove every connectors connected to the engine side around the relay box area.
33. Disconnect the relay box front side positive terminal.
34. Disconnect the fuel feed and the return hose on the fuel tube side.

Caution:

Make sure to place a hole cap to avoid any fuel leak.

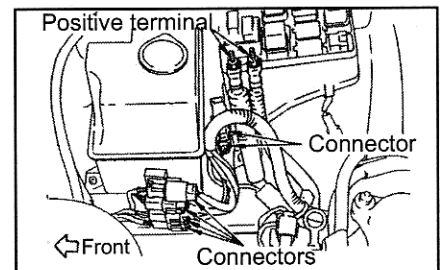

35. Disconnect the brake booster vacuum hose from the intake manifold collector side.
36. Disconnect the vacuum hose (between intake manifold collector and the throttle sensor). (RB25DET)
37. Disconnect the heater hose.
 - Place a hole cap so the coolant within the engine will not leak when the engine is lifted.

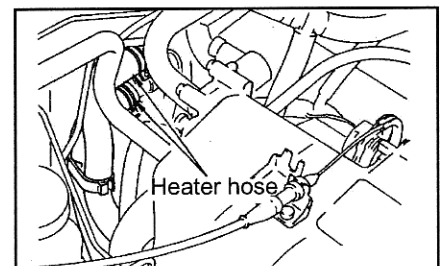

RB25DE / RB25DET ENGINE

[Lower engine]

38. Disconnect the exhaust front tube from the exhaust manifold.
39. Disconnect the A / T control gauge.
40. Disconnect the propeller shaft.
 - Place a hole cap on the rear part of the transmission to avoid transmission oil from leaking when the engine is lifted up.
41. Disconnect every connector behind transmission.

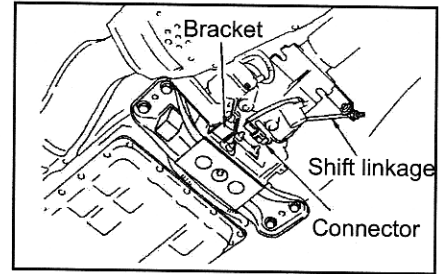

[Engine right & left]

42. Install the engine sling to engine front right and engine rear left.
 - Place the chain block hook on to the engine sling and support it with the hoist.

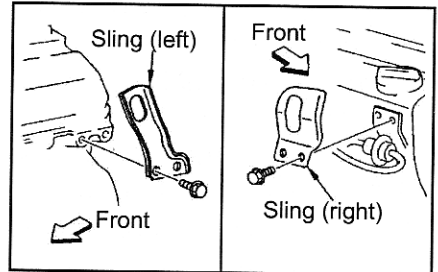
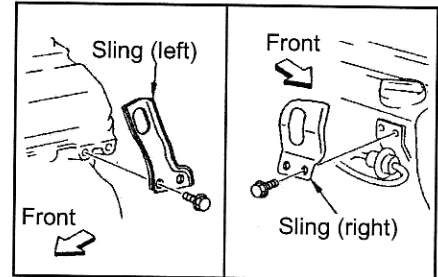

43. Remove right and left gasket.

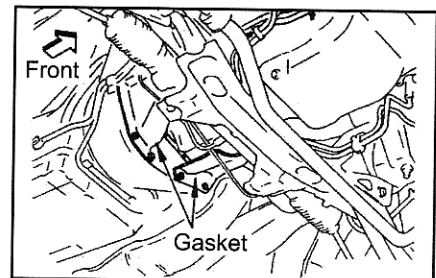

44. Support the transmission using the transmission jack.

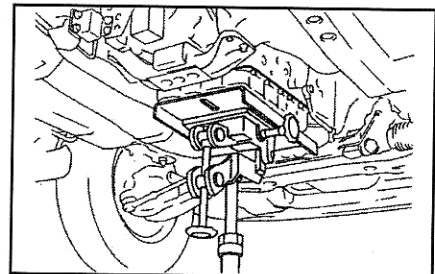

RB25DE / RB25DET ENGINE

45. Remove the front side right and left engine mount installation nuts. (RB25DE)

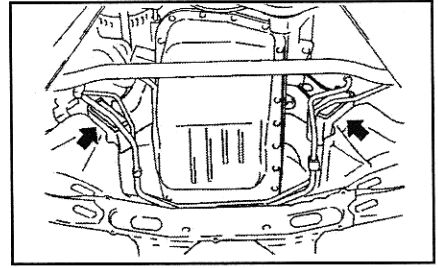

(RB25DET)

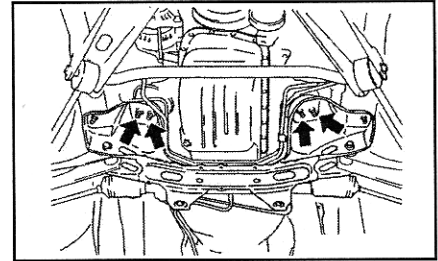

46. Lift up the engine until there is no load to insulator and remove the mount bracket and the insulator (RB25DET).

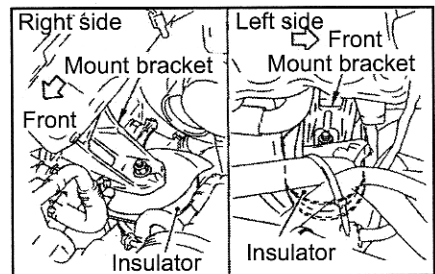

47. Remove the engine rear member and the insulator.

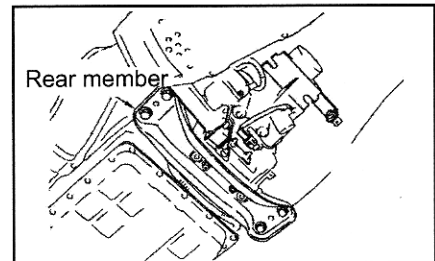

48. Lift up the engine and the transmission ASSY carefully by changing the angle of the engine and the transmission frequently.
- Check to make sure you have not forgotten to remove or disconnect any pipes or wiring.
 - Extra caution must be taken not to allow any parts to come in contact with the vehicle exterior especially the front tip of the transmission and the oil tubes around the steering cylinder, crank pulley and the air conditioner condenser.

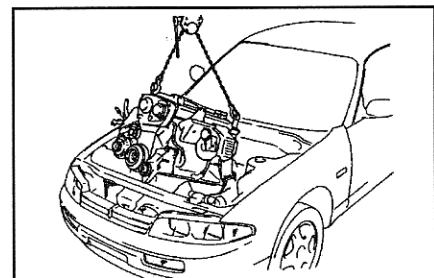

Installation

Install the parts in reverse order to the removal procedure.

- Tighten installation bolts and nuts making sure there are no problems with any of the mount insulators.
- Carry out the accelerator wire adjustment.
- Adjust auxiliary belt tension.
- Carry out idle inspection and adjustment.

Inspection

- Before starting the engine be sure to check the level of engine oil, coolant, power steering oil and A / T fluid oil. Top up if level of any fluid is inadequate.
- Start the engine and check for any abnormal noise or movement from any parts.
- Warm up the engine sufficiently and check that coolant, engine oil, A / T fluid, fuel and exhaust gas are not leaking.

RB26DETT ENGINE

ENGINE REMOVAL (RB26DETT)**Caution:**

- Extra safety precautions must be taken and do not carry out unnecessary operation.
- Do not carry out any operation until exhaust system has cooled down.
- Make sure to support the vehicle at correct position when lifting up the vehicle.

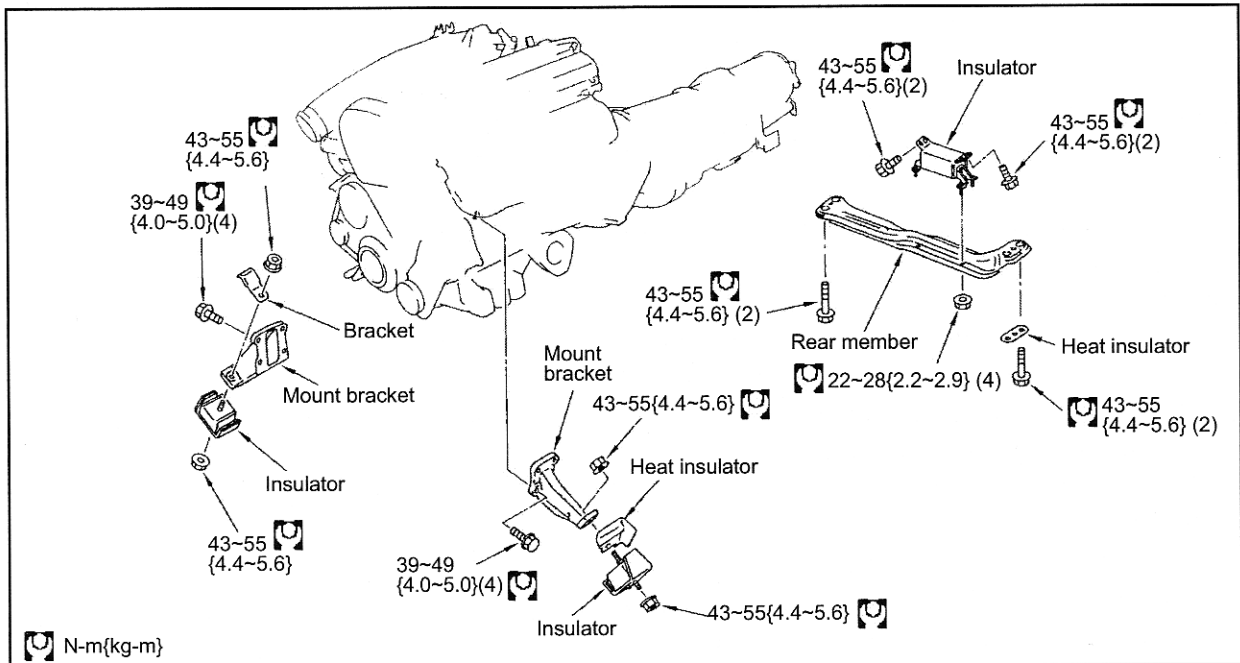
**Removal**

1. Release the fuel pressure.
2. Remove the battery negative terminal.
3. Remove the engine hood.
4. Remove the front strut tower bar.
5. Remove the front spoiler under cover.
6. Remove the under cover.
7. Drain coolant from the radiator drain plug.
8. Drain coolant from the cylinder block drain plug.
9. Remove the air duct, air cleaner case and the air hose.
10. Remove the cooling fan.
11. Remove the radiator.
12. Remove the auxiliary belt.

[Engine left]

13. Disconnect two canister hoses.
14. Disconnect the earth wire between the exhaust manifold cover and the vehicle body at the vehicle body side.
15. Remove the following harness connectors and the terminals at the engine side:
 - O₂ sensor
 - Power transistor unit / power transistor unit earth wire.
 - air conditioner compressor

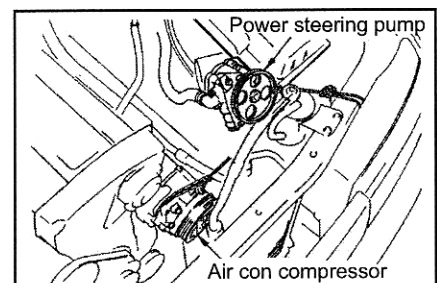

RB26DETT ENGINE

16. Remove the air conditioner compressor from the bracket and use rope to fix it on to the vehicle body side.
17. Remove the power steering pump from the bracket and use rope to fix it on to the vehicle body side.
18. Remove the power steering pump adjust bar.

[Engine right]

19. Remove the accelerator cable from the throttle drum.
20. Disconnect the fuel feed and the return hoses on the fuel tube side.

Caution:

Make sure to place a hole cap to avoid any fuel leak.

21. Remove the following harness connectors and the terminals at the engine side:

- Engine coolant temperature sensor / thermal transmitter.
- Throttle sensor / throttle valve switch
- Fuel injector / intake air temperature sensor
- Ignition coil main harness / AAC valve
- Power steering pipe pressure sensor / crank angle sensor
- Intake manifold front side two earth wires
- Engine earth wire

22. Remove all connectors around the relay box that is connected to the engine side.

23. Remove the relay box front side positive terminal.

24. Remove two earth terminals.

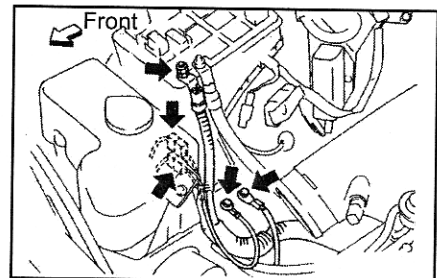

25. Disconnect the vacuum hose between the brake booster and the intake manifold collector at intake manifold collector side.

26. Remove the heater hoses (return and feed).

- Place a hole cap so the coolant within the engine will not leak when the engine is lifted.

27. Disconnect two oil cooler hoses as engine side and place a hole cap.

28. Remove two air hoses from the boost control solenoid.

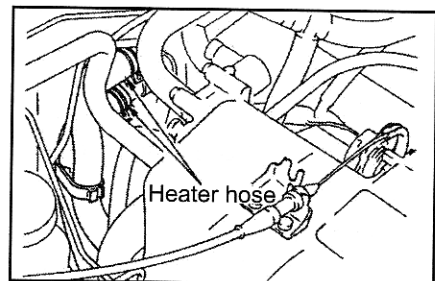

[Interior]

29. Remove the shift rod.

- Place a hole cap on the transmission after removing the shift rod to avoid oil leakages.

RB26DETT ENGINE

[Lower engine]

30. Remove the exhaust front tube from the exhaust manifold.
31. Remove the clutch operation cylinder.
32. Remove the E-TS oil line from rear end of the transfer.
33. Remove the propeller shaft.
 - Place a hole cap on the rear part of the transmission to avoid transmission oil from leaking when the engine is lifted up.
34. Remove right and left front drive shaft.

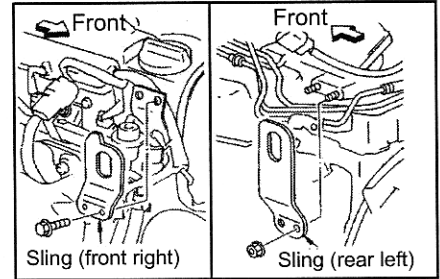
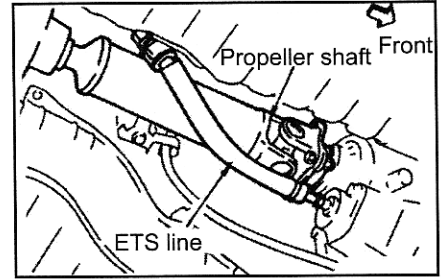

[Engine right & left]

35. Install the engine sling to engine front right and engine rear left.
36. Place the chain block hook on to the engine sling and support it with the hoist.
37. Support the lower part of the transmission with the transmission jack.
38. Remove the rear member and the insulator.

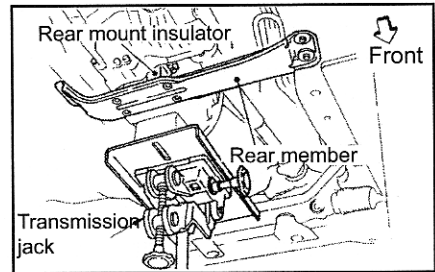

39. Remove right and left engine mount installation nuts.

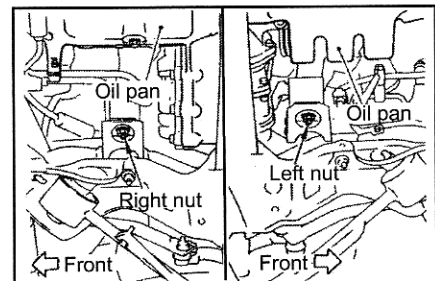

40. Carefully remove the engine, transmission and the transfer ASSY by frequently changing the angle.
 - Check to make sure you have not forgotten to remove or disconnect any pipes or wiring.
 - Extra caution must be taken not to allow any parts to come in contact with the vehicle exterior especially the front top of the transmission and the oil tubes around the steering cylinder, crank pulley and the air conditioner condenser.

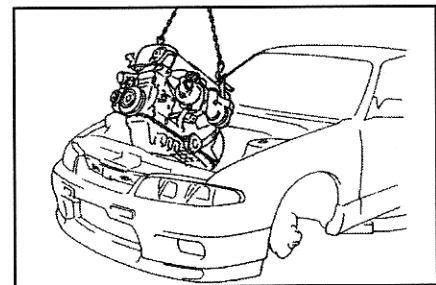

RB26DETT ENGINE

Installation

Install the parts in reverse order to the removal procedure.

- Tighten the installation bolts for the rear member in the order shown.
- Tighten bolt (A) then bolt (B) for the right and left engine mount bracket.
- Tighten each installation bolts and nuts making sure the mount insulator is fitted correctly.

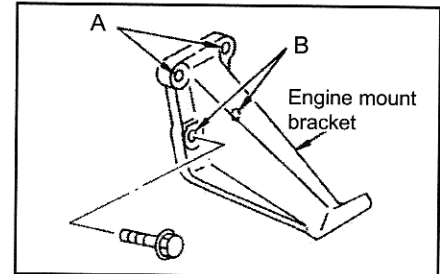
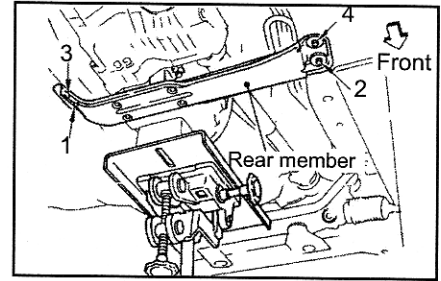
**Inspection**

- Before starting the engine be sure to check the level of engine oil, coolant, power steering oil and transmission fluid oil. Top up if level of any fluid is inadequate.
- Start the engine and check for any abnormal noise or movement from any parts.
- Warm up the engine sufficiently and check that coolant, engine oil, transmission fluid, fuel and exhaust gas are not leaking.

EN5 SYSTEM OUTLINE

1. CIRCUIT DIAGRAM (RB20E)

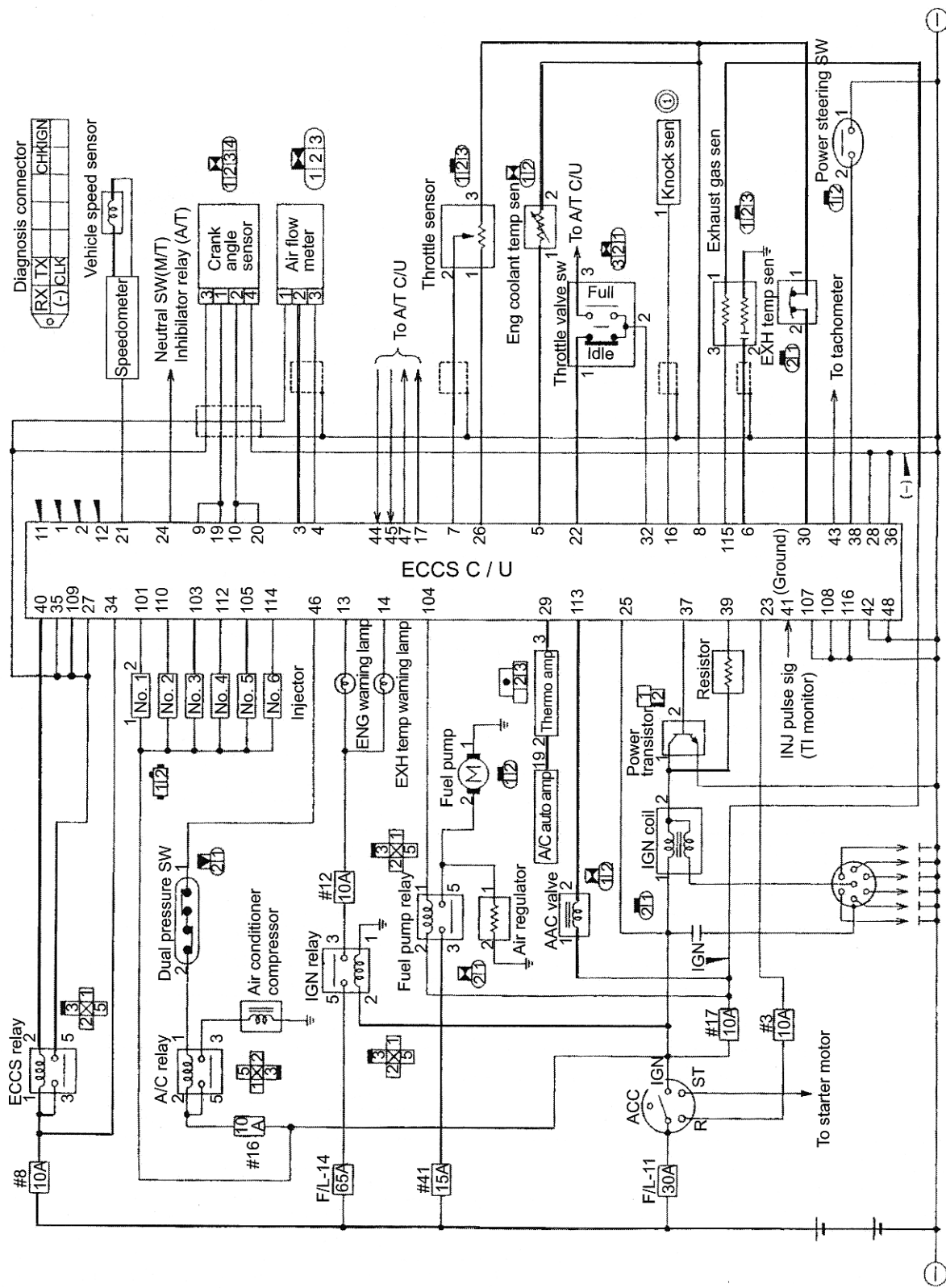

RB20E ENGINE

2. ECCS CONTROL UNIT PIN LAYOUT (RB20E)

101	102	103	104	105	106	107	108
109	110	111	112	113	114	115	116

37	38	39	40	41	42
43	44	45	46	47	48

1	2	3	4	5	6	7	8	9	10
11	12	13	14	15	16	17	18	19	20

21	22	23	24	25	26	27	28
29	30	31	32	33	34	35	36

RX	TX			CHK	IGN
(-)	CLK				

Terminal No.	Description	Terminal No.	Description
1(RX)	Receive (C / U data reception)	11(CLK)	Clock (synchronization signal)
2(TX)	Transmit (data sent from C / U)	12(CHK)	Check (diagnosis activation)
3	Air flow meter intake air signal	13	Engine warning lamp
4	Air flow meter earth	14	Exhaust temperature warning lamp
5	Engine coolant temperature sensor signal	15	-
6	Exhaust gas sensor signal	16	Knock sensor
7	Throttle sensor opening signal	17	Throttle opening output signal (to A/T C/U) (A/T vehicles)
8	Earth (throttle sensor, engine coolant temp sensor, exhaust temp sensor)	18	-
9	Crank angle sen 120° sig (REF)	19	Crank angle sensor (120° signal)
10	Crank angle sen 1° sig (POS)	20	Crank angle sensor (1° signal)
21	Vehicle speed sensor signal	29	Air conditioner SW
22	Throttle valve SW (Idle connection point)	30	Exhaust temperature sensor signal
23	Key SW START signal	31	-
24	Neutral SW	32	Throttle valve SW (Power supply)
25(IGN)	Key SW IGN signal	33	-
26	Throttle sensor power supply	34	Battery power supply
27	C/U power supply	35	C/U power supply
28	C/U earth	36	C/U earth
37	Ignition signal (Power transistor)	43	Tachometer engine turn signal
38	Power steering oil pressure SW	44	Engine A/T control input signal (DT1) (A/T vehicle)
39	Ignition signal check (Turn signal)	45	Engine A/T control input signal (DT2) (A/T vehicle)
40	ECCS relay	46	Air conditioner relay (A/C cut signal)
41	Injection pulse (Ti monitor) signal	47	Engine A/T control input signal (DT3) (A/T vehicle)
42	Earth (Ignition signal)	48	Earth (Ignition signal system)
101	Injector No.1	109	Inverse current feedback circuit
102	-	110	Injector No.2
103	Injector No.3	111	-
104	Fuel pump relay	112	Injector No.4
105	Injector No.5	113	AAC valve control signal
106	-	114	Injector No.6
107	Injector ground	115	Exhaust gas sensor heater ground
108	Injector ground	116	Injector ground

RB25DE / RB25DET ENGINE

1. CIRCUIT DIAGRAM (RB25DE / RB25DET)

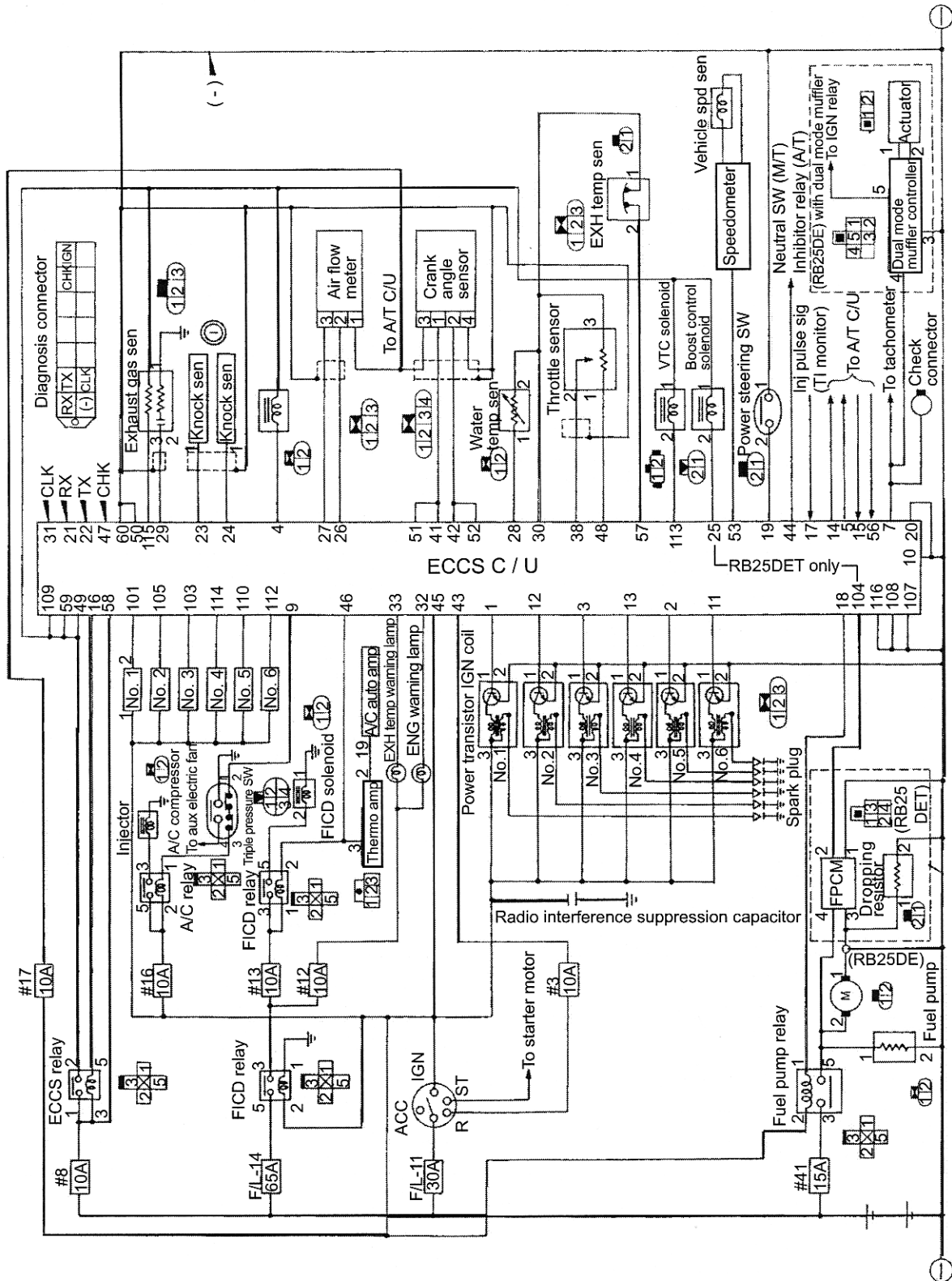

RB25DE / RB25DET ENGINE

2. ECCS CONTROL UNIT PIN LAYOUT (RB25DE / RB25DET)

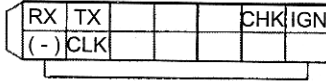
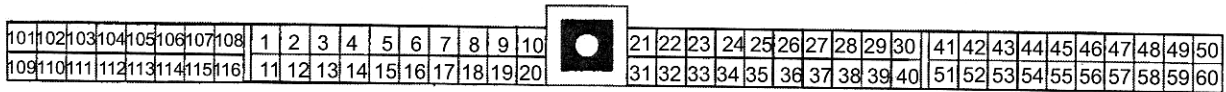

Terminal No.	Description	Terminal No.	Description
1	IGN SIG (pwr transistor ctrl sig) Cyl. No. 1	11	IGN SIG (pwr transistor ctrl sig) Cyl. No. 6
2	IGN SIG (pwr transistor ctrl sig) Cyl. No. 5	12	IGN SIG (pwr transistor ctrl sig) Cyl. No. 2
3	IGN SIG (pwr transistor ctrl sig) Cyl. No. 3	13	IGN SIG (pwr transistor ctrl sig) Cyl. No. 4
4	AAC valve control signal	14	Engine A/T control input signal (DT2)(A/T)
5	Engine A/T control input signal (DT1)(A/T)	15	Engine A/T control input signal (DT3)(A/T)
6	-	16	ECCS relay
7	Engine rev signal for tachometer	17	Injection pulse (Ti monitor) signal
8	-	18	Fuel pump relay
9	Air conditioner relay (A/C cut signal)	19	Power steering oil pressure SW signal
10	Earth (Ignition signla system)	20	Earth (Ignition signal system)
21(RX)	Receive (C/U data reception)	31(CLK)	Clock (synchronized signal)
22(TX)	Transmit (Data to C/U)	32	Engine warning lamp
23	Knock sensor signal 1 (Cyl. 1~3)	33	Exhaust temperature warning lamp
24	Knock sensor signal 2 (Cyl. 4~6)	34	-
25	Boost control solenoid sig (RB25DET only)	35	-
26	Air flow meter earth	36	-
27	Air flow meter intake air quantity signal	37	-
28	Engine coolant temperature sensor signal	38	Throttle sensor opening signal
29	Exhaust gas sensor signal	39	-
30	Earth (Sensor signal system)	40	-
41	Crank angle sensor 120° signal (REF sig)	51	Crank angle sensor 120° signal (REF sig)
42	Crank angle sensor 1° signal (POS sig)	52	Crank angle sensor 1° signal (POS sig)
43	Key SW START signal	53	Vehicle speed sensor
44	Neutral SW	54	-
45(IGN)	Key SW IGN signal	55	-
46	Air conditioner SW signal	56	Throttle opening output signal
47(CHK)	Check (diagnosis)	57	Exhaust temperature sensor signal
48	Throttle sensor power	58	Battery power
49	C/U power	59	C/U power
50	C/U earth	60(-)	C/U earth
101	Injector No.1	109	Inverse current feedback circuit
102	-	110	Injector No.5
103	Injector No.3	111	-
104	Fuel pump terminal power control output signal (FPCM)(RB25DET only)	112	Injector No.6
105	Injector No.2	113	Variable valve timing solenoid
106	-	114	Injector No.4
107	Injector ground	115	Exhaust gas sensor heater ground
108	Injector ground	116	Injector ground

RB26DETT ENGINE

1. CIRCUIT DIAGRAM (RB26DETT)

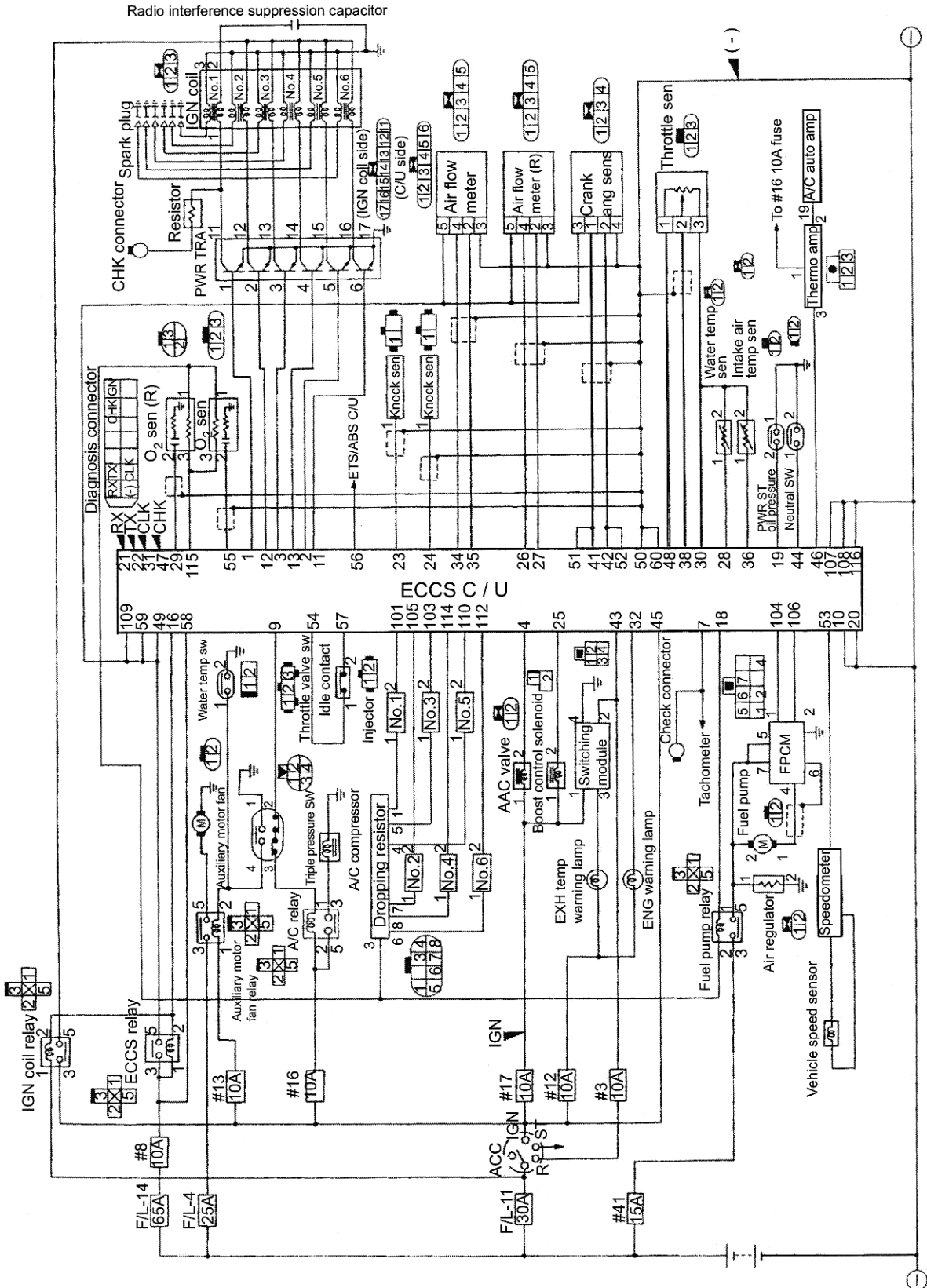

RB26DETT ENGINE

2. ECCS CONTROL UNIT PIN LAYOUT (RB26DETT)

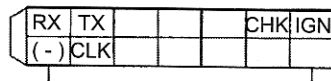
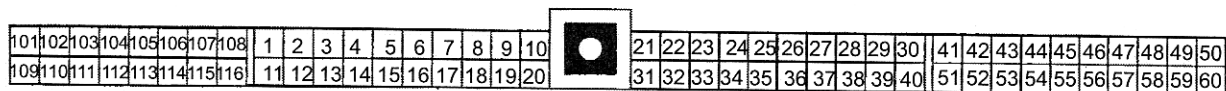

Terminal No.	Description	Terminal No.	Description
1	IGN SIG (pwr transistor ctrl sig) Cyl. No. 1	11	IGN SIG (pwr transistor ctrl sig) Cyl. No. 6
2	IGN SIG (pwr transistor ctrl sig) Cyl. No. 5	12	IGN SIG (pwr transistor ctrl sig) Cyl. No. 2
3	IGN SIG (pwr transistor ctrl sig) Cyl. No. 3	13	IGN SIG (pwr transistor ctrl sig) Cyl. No. 4
4	AAC valve control signal	14	-
5	-	15	-
6	-	16	ECCS relay
7	Tachometer engine rev signal	17	Injection pulse (Ti monitor) signal
8	-	18	Fuel pump relay
9	Air conditioner relay (A/C cut signal)	19	Power steering oil pressure SW signal
10	Earth (Ignition signla system)	20	Earth (Ignition signal system)
21(RX)	Receive (C/U data reception)	31(CLK)	Clock (synchronized signal)
22(TX)	Transmit (Data to C/U)	32	Engine warning lamp
23	Knock sensor signal 1 (Cyl. 1~3)	33	-
24	Knock sensor signal 2 (Cyl. 4~6)	34	Air flow meter earth
25	Boost control solenoid signal	35	Air flow meter intake air quantity signal
26	Air flow meter (R) earth	36	Intake air temperature sensor signal
27	Air flow meter (R) intake air quantity signal	37	-
28	Engine coolant temperature sensor signal	38	Throttle sensor opening signal
29	Exhaust gas sensor (R) signal	39	-
30	Earth (Sensor signal system)	40	-
41	Crank angle sensor 120° signal (REF sig)	51	Crank angle sensor 120° signal (REF sig)
42	Crank angle sensor 1° signal (POS sig)	52	Crank angle sensor 1° signal (POS sig)
43	Key SW START signal	53	Vehicle speed sensor
44	Neutral SW	54	Throttle valve SW (Idle contact)
45(IGN)	Key SW IGN signal	55	Exhaust gas sensor signal
46	Air conditioner SW signal	56	Throttle opening output signal
47(CHK)	Check (diagnosis)	57	Throttle valve SW power
48	Throttle sensor power	58	Battery power
49	C/U power	59	C/U power
50(-)	C/U earth	60(-)	C/U earth
101	Injector No.1	109	Inverse current feedback circuit
102	-	110	Injector No.5
103	Injector No.3	111	-
104	Fuel pump terminal power control output signal (FPCM)2	112	Injector No.6
105	Injector No.2	113	-
106	Fuel pump terminal power control output signal (FPCM)1	114	Injector No.4
107	Injector ground	115	Exhaust gas sensor heater ground
108	Injector ground	116	Injector ground

EN6 ECCS (ELECTRONICALLY CONCENTRATED ENGINE CONTROL SYSTEM)

1. FOR ACCURATE & QUICK DIAGNOSIS

GENERAL OUTLINE

Main control such as fuel injection control, ignition timing, idling control etc. are controlled by ECCS C/U. ECCS C/U will receive input signal from sensors and then immediately send out output signal to the actuator.

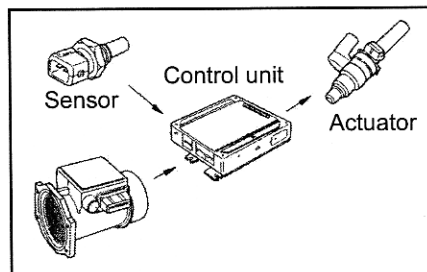

Most faults that occurs rarely are due to bad electrical contact or faulty wiring. In these cases it is necessary to inspect faulty circuit carefully to avoid replacing correctly operating parts. Use a circuit tester to diagnose a faulty circuit as inspecting visually is not enough to diagnose the faults.

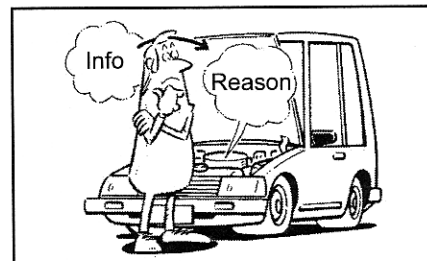

Before starting inspection ask your customer in detail about the conditions of its occurrence.

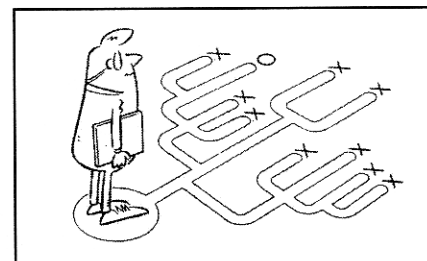

OPERATION ORDER

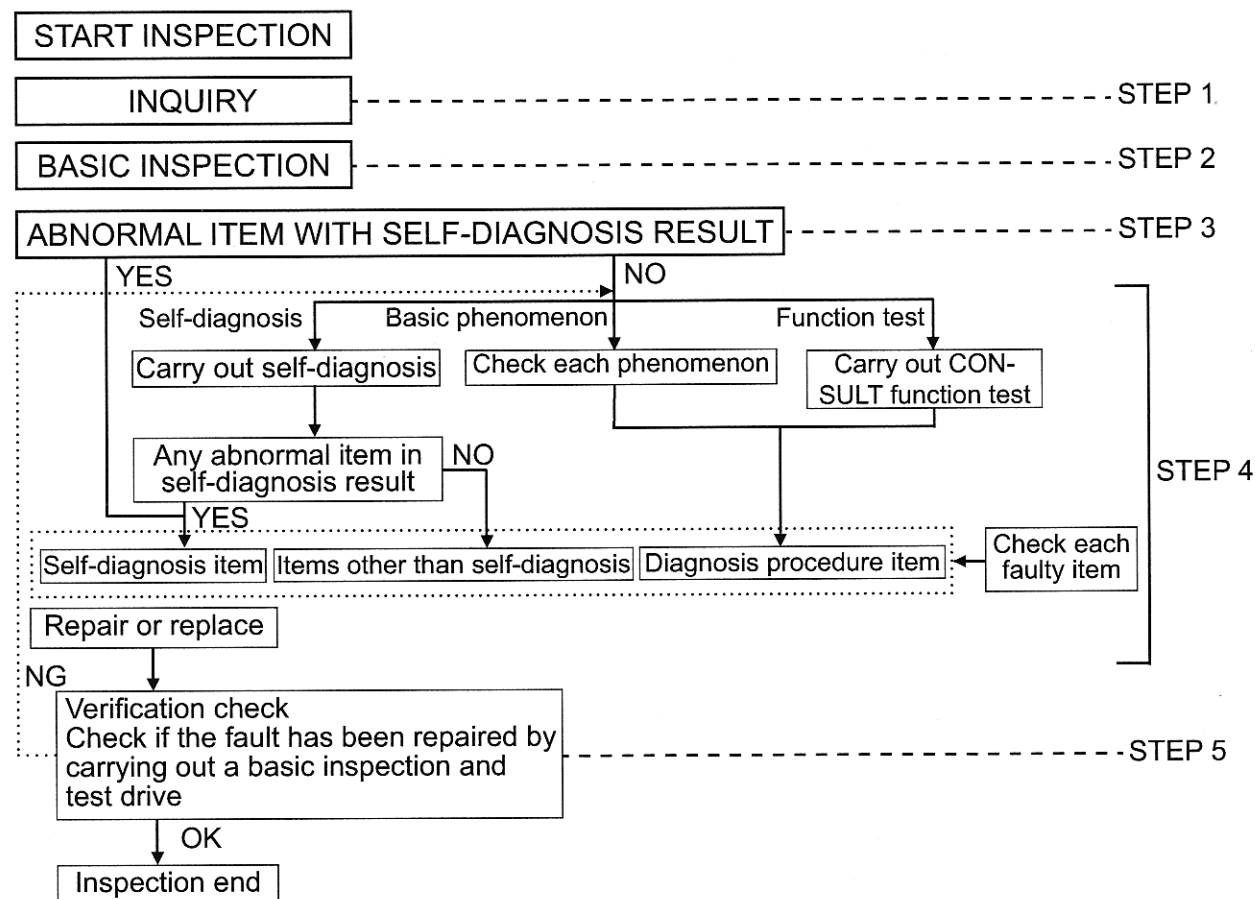

STEPS	DESCRIPTION
STEP 1	Follow the diagnostic worksheet on the following page.
STEP 2	Carry out the basic inspection.
STEP 3	Inspect the self-diagnosis results memorised in ECCS C/U.
STEP 4	<p>According to verified faults, select inspections from below:</p> <ol style="list-style-type: none"> 1. Self-diagnosis Operate self-diagnosis mode 2 and carry out the inspection according to the self-diagnosis result. 2. Phenomenon This inspection is a simplified method. To inspect each parts it is necessary to select the relevant inspection item from the diagnosis procedure items. 3. Function test This inspection is a basic inspection of the fault diagnosis. In this inspection the CONSULT will display OK or NG after diagnosing the faulty system. 4. Diagnosis procedure <ul style="list-style-type: none"> • Carry out this inspection using the data created when faults are detected in related circuits or when there is a fault with harness circuit. • Inspections for "Items not in self-diagnosis" cannot be verified in self-diagnosis mode. • If the system that comprises self diagnosis function includes the circuit that can not be self-diagnosed, it is necessary to select "items not in self-diagnosis" even when the self-diagnosis result shows "OK". <p>Example: Crank angle sensor</p>
STEP 5	<ul style="list-style-type: none"> • Verification inspection must be carried out to check if the servicing is done correctly and installation after the service has been done correctly. • Same fault phenomenon has reoccurred in the verification inspection. • Return to step 4 and carry out inspection using different method.

DIAGNOSTIC WORKSHEET

- Feeling for a problem depends on each customer. It is important to fully understand the phenomenon and conditions of a vehicle when a customer complains.
- Check with your customer in what conditions the problem occurs in and use as a reference when carrying out test drive.
- Make good use of a diagnostic worksheet such as the one shown below in order to utilize all complaints for troubleshooting.

KEY POINTS	
What	Vehicle & engine model
When	Date, frequencies
Where	Road condition
How	Drive condition & circumstances

Diagnostic worksheet							
Customer name MR / MRS / MISS / MRS		Registration No.			Initial registry date		
		Vehicle type			Chassis No.		
Manuf. Date		Engine		T / M	M / T, A / T	Mileage	(km)
Phenomenon	Starting	• No initial combustion • Partial combustion • Hard to start (cold climate, warm climate, constantly) • Other [_____]					
	Idling	• No fast idling • High idle • Low idle • Idling unstable (cold climate, warm climate, constantly) • Other [_____]					
	Driving	• Stumble • Knocking • Backfire • Lack of power • Lack of acceleration • Other [_____]					
	Engine stall	• At start • At idle • While driving • After stopping • While loading (battery load, power steering) • Other [_____]					
Initial occurrence		• Since new • Recently					
Frequency		• All the time • Under certain condition • Sometimes					
Weather	Not affected						
	Weather	• Fine • Cloudy • Raining • Snowing • Other [_____]					
	Temperature	• Hot • Warm • Cool • Cold • Temperature (°C)					
Engine conditions		• Cold • After warm-up • During warm-up • Water temp (°C)					
Road conditions		• City area • In suburb • High-way • Hilly area					
Driving conditions		• Does not affect • At start • At idle • At racing • While driving • While accelerating • At constant speed • While decelerating [Vehicle speed: _____ km/h, Engine rev: _____ rpm, M/T _____ gear] • At curve (• Right curve • Left curve)					
Other condition							

PHENOMENON CONFIRMATION

- Customer's explanation is often insufficient in clarifying the status of the problem. Reproduction of the problem on the actual car and its confirmation and analysis are therefore essential. If unable to reproduce the problem, ask the customer in detail about its occurrence conditions and try to reproduce it under the indicated conditions. If unable to reproduce, manually shake the concerned harness to check for poor contacts or other problems.
- It is also recommended to collect and analyse the data using CONSULT while driving.
- When checking the actual vehicle, record data on normal portions to assist in diagnosing a problem.

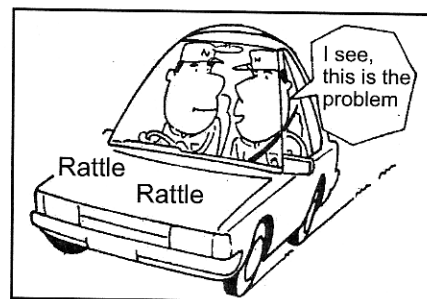

Variant factor	Affecting component	Target	Method
Air fuel ratio	Pressure regulator	Lean	Carry out active test and function test using CONSULT. OR remove vacuum hose and apply negative pressure using the vacuum pump.
		Rich	Carry out active test and function test using CONSULT. OR remove vacuum hose and apply pressure using the vacuum pump.
Ignition timing	Crank angle sensor	Increase angle	Rotate the crank angle sensor clockwise.
		Decrease angle	Carry out active test and function test using CONSULT. OR rotate the crank angle sensor anti-clockwise.
Air fuel ratio control	O ₂ sensor	Shutdown temporary	Carry out active test and function test using CONSULT. OR remove O ₂ sensor harness connector.
	Control unit	Operation check	Carry out active test and function test using CONSULT. OR carry out self diagnosis mode 2 at 2000rpm.
Idle rev	AAC valve	Increase rev	Carry out active test and function test using CONSULT. OR rotate idle adjust screw anti-clockwise.
		Decrease rev	Carry out active test and function test using CONSULT. OR rotate idle adjust screw clockwise.
Harness cables	Harness connector and circuit	Default connector contact or default circuit	Tap or shake lightly. Turn the engine quickly and check default contact caused by engine torque movement.
Temperature	Control unit	Cool down	Cool down using ice etc. (do not over cool)
		Warm up	Warm it up using the heat gun etc. (do not overheat)
Humidity	Electronic parts	Moisten	Moisten (Do not pour water directly on the unit)
Electricity load	Switch load	Apply load	Turn ON the headlight switch, air conditioner, rear defogger etc.
Idle switch condition	Control unit	ON-OFF switch	Operate the acceleration (open / close)
Ignition spark	Timing light	Correct ignition	Check each cylinder ignition using timing light flashes.

CAUTIONS WHEN CARRYING OUT DIAGNOSIS

- Remove the battery terminals and place ignition switch in the OFF position when removing or connecting ECCS C/U harness connector from ECCS C/U.
- Position the connector and tighten the installation screw until orange projection is at level with surface when connecting ECCS C/U harness connector.
- Check the connector pin terminals for any bends or deformities when removing or connecting ECCS C/U harness connector.
- Be sure to carry out components function inspection and ECCS C/U input signal inspection before replacing ECCS C/U.
- After "Diagnosis procedure" carry out the test drive and self-diagnosis.
- Short-circuits will occur if probes from the same position come into contact when measuring the battery voltage of ECCS C/U components using the circuit tester. Be sure to connect one side of tester probe to different place.

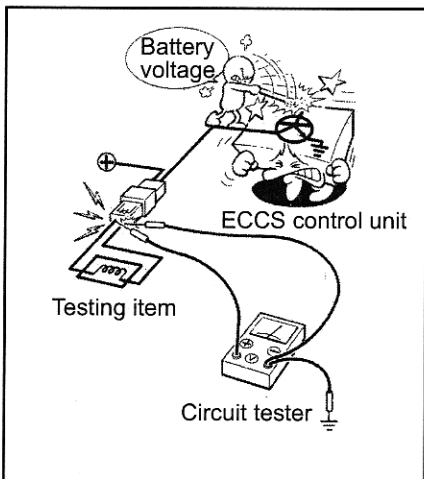
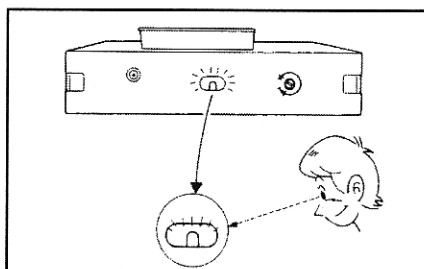
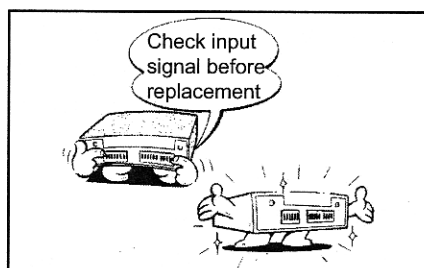
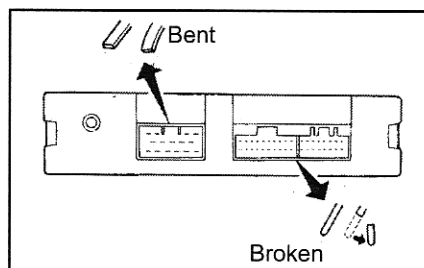
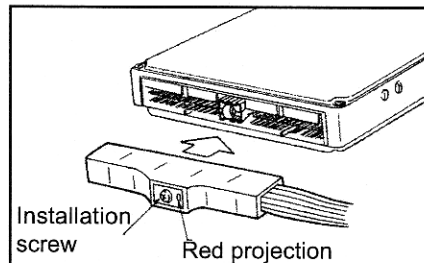
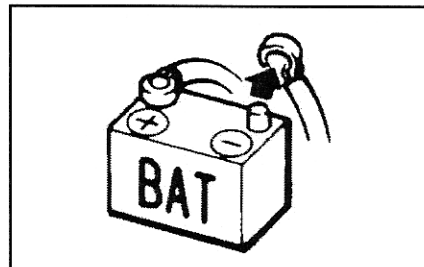

CAUTIONS WHEN HANDLING ECCS C/U**ECCS C/U installation**

- Only install ECCS C/U specified for your vehicle.
- Do not apply unnecessary power to installation bracket.

Connector removal

Keep the following points in mind when removing or installing the connector:

Removal:

- Make sure the ECCS relay is OFF after placing the ignition switch in the OFF position.
- Hold the connector body to remove the connector. Do not pull the harness to remove.

Installation:

- Install the connector when the ignition switch is in the OFF position.
- Check ECCS C/U side connector pin for any bend or deforming before installation.
- Tighten the bolts securely until red projection is level with the surface.

ECCS C/U voltage

- Never connect the battery in reverse.
- The battery voltage should be between 10V ~ 16V.

Idle rev adjustment volume

- Do not turn the knob over the lock position.
- Do not operate the adjustment volume when at below 0°C.

Moisture & oil content

- Care must be taken to keep all rain drops and water droplets away from ECCS C/U.
- Take note of water droplets from rapid temperature change. Make sure ECCS C/U has dried completely before installing in the vehicle.
- Do not allow oil content to adhere to the connector device.
- Do not use benzine or white spirit to clean the ECCS C/U.

Dropping & strong impact

- Do not drop, hit or apply strong impact to the ECCS C/U device.
- Do not use a ECCS C/U with deformed top or bottom cover.

ECCS C/U screw & cover

- Do not remove the ECCS C/U upper and lower cover.
- Do not turn screws on ECCS C/U body.

2. DIAGNOSIS ITEMS BY PHENOMENON

- (1) Unable to start.....No initial combustion.
- (2) Unable to start.....Initial combustion occurs but is not complete.
- (3) Difficult to start.....Hard to start when engine is cold.
- (4) Difficult to start.....Hard to start after engine warm up.
- (5) Difficult to start.....Hard to start when engine is hot or cold.
- (6) Poor idlingFast idling inoperative.
- (7) Poor idlingLow idle rpm (after warm up).
- (8) Poor idlingHigh idle rpm (after warm up).
- (9) Unstable idling.....Engine is cold.
- (10) Unstable idling.....After engine warm up.
- (11) Poor driveability.....Engine breathing.
- (12) Poor driveability.....Knocking.
- (13) Poor driveability.....Lack of output, poor acceleration, poor response.
- (14) Engine stalls when starting to drive.
- (15) Engine stalls while idling.
- (16) Engine stalls while driving.
- (17) Engine stalls when decelerating or immediately after stopping.
- (18) Engine stalls when electrical load or power steering load is applied.

(1) Unable to start.....No initial combustion.

[Analysis]

- Ignition spark is not generated or no fuel is injected.
 - Check if the fuel pump is rotating.
 - If no ignition spark is generated and no injector operating noise can be heard, check the control unit input (crank angle sensor signal) or control unit power supply.
 - If the injector is operating but no spark is generated, the control unit and crank angle sensor can be considered as normal. Check the ignition output system (power transistor, ignition, coil etc.)
 - If an ignition spark is generated but the injector is not operating, check the ignition output system (injector power supply, harness etc.)

[Chart]

FUEL PUMP

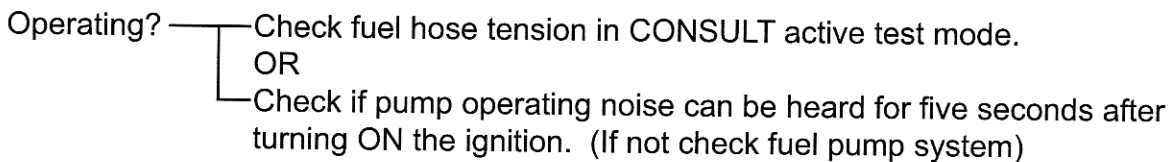

INJECTOR

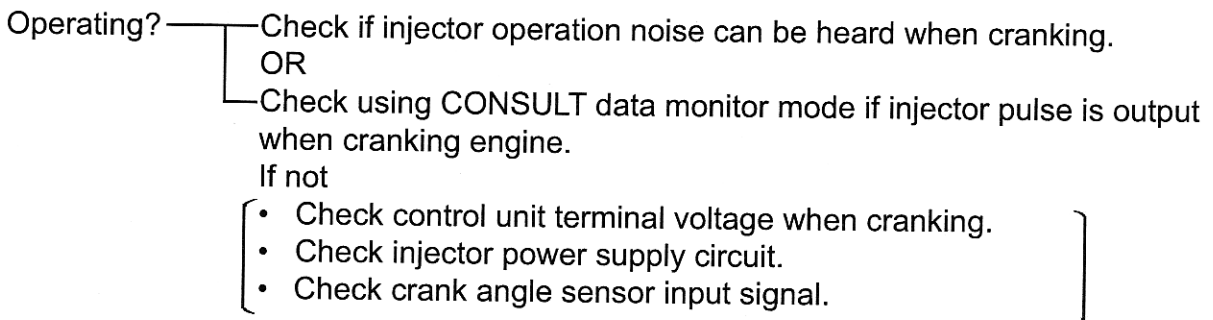

IGNITION SPARK

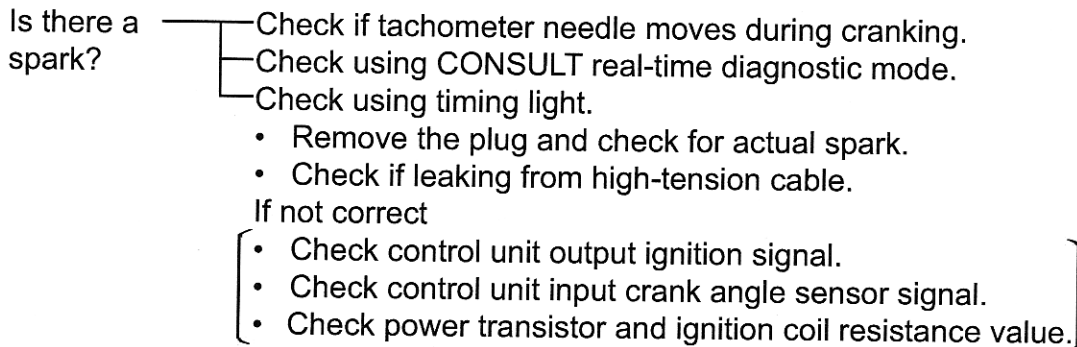

(2) Unable to start.....Initial combustion occurs but is not complete.

[Analysis]

Occurrence of initial combustion means that sparks are created. The following three cases are possible:

1. Initial combustion only.
 - Is fuel system working? (fuel pump, injector etc.)
2. Engine fires incompletely.
 - Check if fuel injection quantity is too small or too large.
 - Check the fuel pressure.
 - Check if water temperature enrichment is provided.
 - Check if start time enrichment is provided.
 - Check if ignition timing is normal.
3. Engine fires completely if accelerator pedal is depressed.
 - Check if AAC valve is operating normally.

[Chart]

FUEL PRESSURE

Is pump operating? ———— Check fuel hose tension in CONSULT active test mode.
OR
Check if pump operating noise can be heard for five seconds after turning ON the ignition.
Is fuel pump operating during cranking?
(If not check fuel pump system)

INJECTION QUANTITY

Water temp enrichment provided? ———— Check water temperature in CONSULT data monitor mode.
OR
Disconnect water temperature sensor and check for any change.

- Check water temperature resistance value.
- Check water temperature sensor output voltage.

Start time enrichment provided? ———— Check "START" signal ON/OFF (CONSULT data monitor mode).

IDLING CONTROL

Is idling rpm increased? ———— Check AAC valve operation (CONSULT active test mode).
Check if AAC valve is fully closed.
Check AAC valve circuit for disconnection or loose connectors.

IGNITION SYSTEM

Ignition timing normal? ———— Try to advance or retard timing angle.

Is ignition correct? ———— Check spark plugs for fouling.
Check for ignition misfiring.
(Check using a timing light or CONSULT real-time diagnostic mode).

(3) Difficult to start.....Hard to start when engine is cold.

[Analysis]

Inspect the system relating to the engine coolant temperature as this problem only occurs when the engine is cold.

- Fuel injection enrichment from the engine temperature sensor signal is not functioning when temperature is low.
- Idling speed control is not functioning.
- Start-time enrichment is not functioning.
- Cranking speed is too low.

[Chart]

ENGINE TEMPERATURE CORRECTION

- Engine temperature sensor sig? — Check using CONSULT data monitor mode.
 OR
 Disconnect engine temperature sensor connector and check for any change.
- Check engine temperature sensor resistance value.
 - Check engine temperature sensor output voltage.
- Idling control? — Check if AAC valve for operation (CONSULT active test).
 — Check if AAC valve is not fully closed.
 — Check AAC valve circuit for disconnection, loose connector etc.

START-TIME ENRICHMENT

- _____ Using CONSULT data monitor mode check if START signal is provided.

CRANKING SPEED

- _____ Is battery normal?
 Inspect starter, starter cables (resistance, poor contact etc.)

(4) Difficult to start.....Hard to start after engine warm up.
--

[Analysis]

This problem may also be related to the water temperature control.

- Check if the engine temperature correction is inaccurate.
- Check if the fuel pressure is correct or if air bubbles are generated in the fuel when the engine is hard to start, especially when water temperature is high.
- Check if the engine cranking speed is low.

[Chart]**ENGINE TEMPERATURE CORRECTION**

Engine temp sensor signal?	—	Inspect using CONSULT data monitor.
		OR
	—	Disconnect engine temperature sensor connector and check for any change.
		• Check engine sensor resistance value.
		• Check engine temperature sensor output voltage.

FUEL PRESSURE

Increase fuel pressure to check	—	Remove vacuum hose from pressure regulator or clamp return hose.
---------------------------------------	---	--

CRANKING SPEED

	—	Is battery normal?
	—	Inspect starting system.

(5) Difficult to start.....Hard to start regardless of engine temperature.

[Analysis]

Spark arc is created but air-fuel ratio could be incorrect.

- Check fuel pressure.
- Check fuel injection quantity. (Is engine temperature correction accurate?)
- Check if idling speed is controlled.
- Check if cranking speed is too low.

[Chart]

FUEL PRESSURE

- Fuel pump — Use CONSULT active test mode to check fuel hose tension.
OR
— Check if you can hear pump operation noise for five seconds after turning ignition switch ON.
- Check if you can hear pump operation noise when cranking.
- Increase fuel pressure — Disconnect vacuum hose from pressure regulator and check for any change. (or clamp return hose)
- Check for clogging — Inspect fuel filter for any clogging.

ENGINE TEMPERATURE CORRECTION

- Engine coolant temp sensor signal — Inspect using CONSULT data monitor.
OR
— Disconnect engine temperature sensor connector and check for any change.
- Check engine temperature sensor resistance value.
 - Check engine temperature sensor output voltage.
- Idling control — Check if AAC valve operation is normal (CONSULT active test).
— Check if AAC valve is not fully closed.
— Check AAC valve connector circuit for disconnection, loose connectors.

IGNITION SYSTEM

- Ignition misfiring — Check in real-time diagnostic mode (CONSULT data monitor).
— Check crank angle sensor output for missing pulses (CONSULT data monitor mode or with oscilloscope).
— Is spark plug gap correct?
— Check for any leak from high-tension cable.
- Ignition timing normal — Check by advancing or retarding the angle.

CRANKING SPEED

- Check the battery.
- Check charged state.
- Check starting system.

(6) Poor idling.....Fast idling inoperative.
--

[Analysis]

This problem may have been caused by abnormal control of AAC valve and air regulator as idling speed is controlled by these devices.

The air-fuel ratio and ignition timing also relate to this problem.

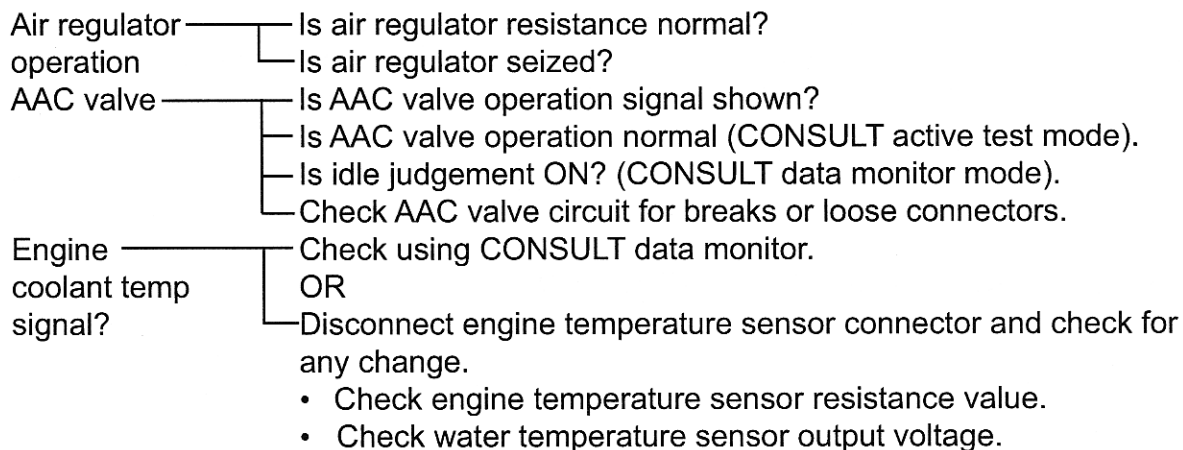
[Chart]**IDLE CONTROL SYSTEM****AIR-FUEL RATIO**

- | | | |
|----------------|---|---|
| Enrich mixture | — | Increase fuel pressure (Disconnect pressure regulator vacuum hose or CONSULT active test). |
| Lean mixture | — | Reduce the fuel pressure (CONSULT active test or apply negative pressure greater than -500 mmHg). |

(7) Poor idling.....Low idle rpm (after warm up).

[Analysis]

Idling speed is controlled by AAC valve. A low rpm means insufficient auxiliary air volume through AAC valve.

[Chart]**IDLE CONTROL SYSTEM**

- AAC valve operation
 - Is AAC valve control signal issued?
 - Is AAC valve operation normal? (CONSULT active test mode).
 - Measure resistance value of AAC valve and check seizure.
 - Check AAC valve circuit for disconnection or looseness.
- Input signal
 - Is idle judgement ON?
 - Is air conditioner switch and neutral switch turned ON? (CONSULT data monitor mode).

CHECK IGNITION TIMING FOR CORRECTION

(8) Poor idling.....High idle rpm (after warm up).

[Analysis]

High idling can be caused by the following points:

- Low engine coolant temperature signal.
- Throttle valve switch (Idle judgement) is OFF.
- Air conditioner switch or power steering switch is constantly in ON position.
- AAC valve is seized.
- Electricity is not conducted to air regulator.
- Air regulator is seized.
- Control unit adjustment volume is set to HIGH.
- Throttle valve is open.
- Air is sucked in.

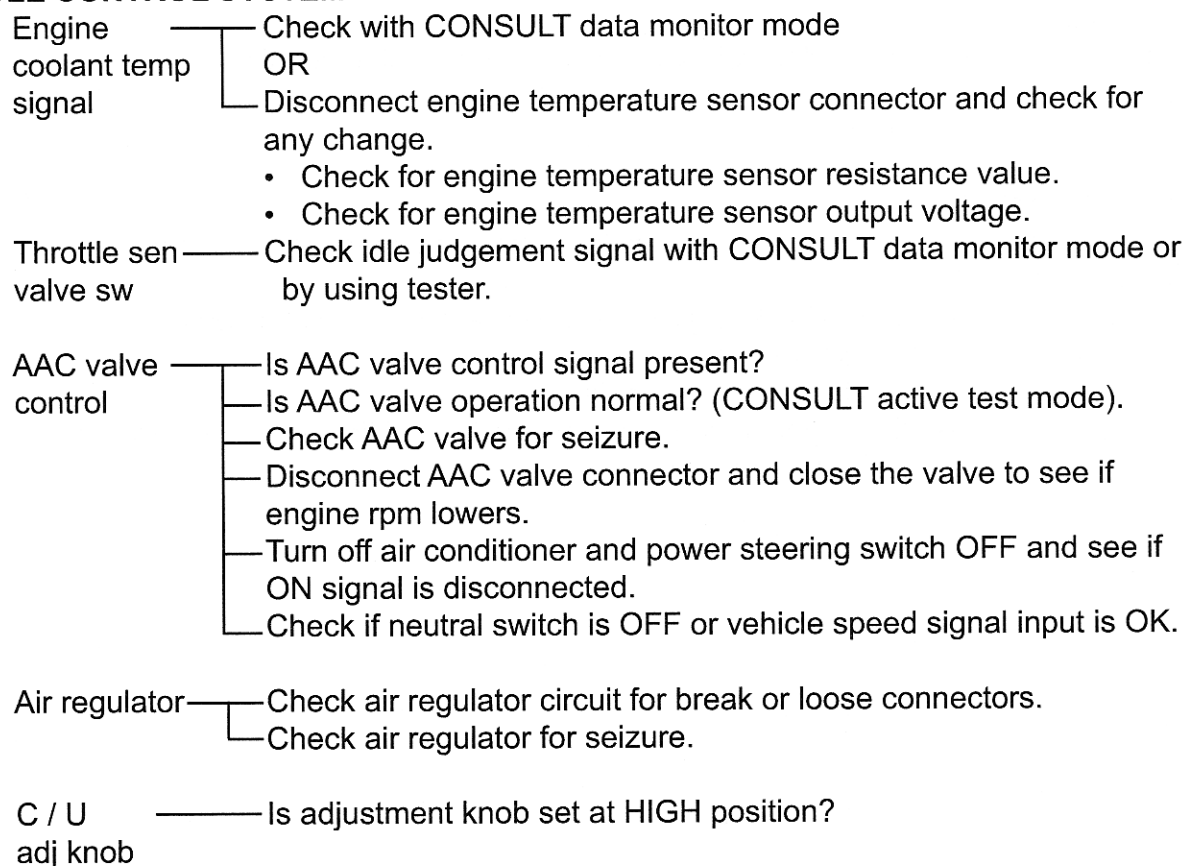
[Chart]**IDLE CONTROL SYSTEM****OTHERS**

- Throttle valve — Is valve open? (Check for bent wiring).
- Air suction — Block blow-by hose passage and check for any change.

(9) Unstable idling.....Cold engine only.

[Analysis]

Since idling is unstable only when the engine is cold, the cause of this problem can be narrowed down to the relationship between the engine temperature and idle control system. It also relates to the air-fuel ratio, ignition timing, misfiring etc.

[Chart]

IDLE CONTROL SYSTEM

- Eng temp sen signal — Inspect using CONSULT data monitor mode.
- Check engine temperature resistance value.
 - Check engine temperature output voltage.
- AAC valve — Check that the valve is closed completely. Check that idle adjustment is within specification.
- Is AAC valve operation normal? (CONSULT active test).

AIR-FUEL RATIO

- Adj the mixture rich or lean — Use CONSULT active test mode to make the mixture rich or lean or disconnect pressure regulator vacuum hose or apply additional vacuum.

IGNITION SYSTEM

- Correct ign timing — Advance or retard ignition timing and check for any change.
- Ignition misfiring — Check crank angle sensor by real time diagnostic method (CONSULT data monitor).
- Check spark plug condition.
- Check ignition system condition by real time diagnostic method (CONSULT data monitor).

(10) Unstable idling.....After warm up.

[Analysis]

Relates to various factors including air-fuel ratio, ignition system and compression. It is necessary to determine factors, beginning with items that are easy to check.

- Idle rpm control system Check for AAC valve operation
- Air-fuel ration Check for fuel pressure
 - Check for injection quantity (Enriched?)
 - Check for air suction
- Ignition system Check ignition timing
 - Ignition misfiring (Missing signal pulse)
- Engine main unit Check for poor compression

[Chart]**IDLE CONTROL SYSTEM**

Disable ctrl function ——— Disconnect AAC valve connector and check for any change.

Control circuit ———

- Check if control signal is present and check signal condition.
- Is AAC valve operation normal? (CONSULT active test).
- Disconnect AAC valve connector and check by adjusting with IAS.
- Check AAC valve for seizure.
- Check if idle judgment is ON (CONSULT data monitor).
- Check circuit for breaks and connectors for looseness.

AIR-FUEL RATIO

Enrich the mixture ——— CONSULT active test or remove pressure regulator vacuum hose.
OR clamp return hose.

Lean the mixture ——— Reduce the mixture ratio by using "FUEL INJECTION" in CONSULT active test mode, or applying vacuum greater than -500mmHg.

Stop feedback ——— Perform CONSULT active test.
OR

— Disconnect engine temperature sensor connector and check for any change.

- Check engine temperature sensor resistance value.
- Check engine temperature sensor output voltage.

Air suction ——— Check vacuum line and blow-by hose.

IGNITION SYSTEM

Ignition timing ——— Advance or retard the ignition timing angle and check for any change.

Ignition misfiring ———

- Check ignition system by real-time diagnosis (CONSULT data monitor mode).
- Check condition of the crank angle sensor by real-time diagnosis.
- Check condition of the spark plug.

ENGINE MAIN BODY

Compression pressure ——— Measure compression pressure (check valve timing, valve seats, piston rings etc.)

(11) Poor driveability.....Engine breathing.

[Analysis]

It is necessary to first verify if the problem occurs during acceleration or during cruising.

1. During acceleration

- Engine breathing while accelerator pedal is depressed may be caused by momentary misfiring or momentary occurrence of lean mixture (ie. no interrupt injection).
- Inclination of engine during acceleration etc. can increase tension of harness or air duct that can cause poor contact.
- Clogging in fuel system is cause for engine breathing. Sufficient fuel pressure cannot be maintained during acceleration.

2. During cruising

- Lean mixture and engine breathing caused by poor feedback of air-fuel ratio data.
- Misfiring of ignition system caused by leaks.
- Poor contact or malfunction of signal system, use of low quality gasoline.

[Chart]**1. During acceleration****AIR-FUEL RATIO**

Stop feedback	Perform CONSULT active test. OR Disconnect exhaust gas sensor.
Enrich mixture	Perform CONSULT active test or disconnect engine temperature sensor and apply 600 Ω resistance after warming up the engine.
Throttle valve switch	Check idle judgement ON/OFF operation in CONSULT data monitor mode.
Throttle sen	Check if output voltage varies with throttle opening.
Fuel pressure	Check if fuel pressure is maintained even while racing the engine.
Air leak	Check air duct looseness.
Air flow mtr output	Check output voltage.

IGNITION SYSTEM

Ignition misfiring	Check signal system (Ignition signal, crank angle sensor signal, air flow meter signal) for instantaneous break by CONSULT data monitor. Check spark plug gap. Check for any leak from high tension cable. Check if ignition coil power supply voltage is lowered.
Ignition timing	Check if fail-safe mode is not set due to a detonation sensor error.

2. When cruising**AIR-FUEL RATIO**

- Feedback function — Perform CONSULT active test.
OR
Disconnect exhaust sensor connector.
- Perform exhaust gas sensor monitor diagnosis to see if exhaust gas warning lamp (or control unit red lamp) is flashing or check by CONSULT data monitor.
- Check if exhaust gas temperature warning lamp (or control unit red lamp) is flashing more than five times in ten seconds when engine is running at 2,000 rpm, or check by CONSULT data monitor.
- Throttle valve switch — Check idling contact point revolution.

IGNITION SYSTEM

- Ignition misfiring — Check for instantaneous break signal system using real-time diagnosis (ignition signal, crank angle sensor signal, air flow meter signal) (Use CONSULT data monitor or oscilloscope).

(12) Poor driveability.....Knocking.

[Analysis]

This problem may be caused by lean air-fuel mixture, incorrect ignition timing or malfunctioning or engine main unit or cooling system.

- Lean mixture ratio may be caused by fuel enrichment correction not working during acceleration, incorrect air flow meter output, incorrect air-fuel ratio feedback correction.
- Errors in initial ignition timing or knock control system relate to the detonation caused by incorrect ignition timing.
- Other causes can be excessively high cooling engine temperature, increased compression ratio due to carbon deposits in combustion chamber etc.

[Chart]**AIR-FUEL RATIO**

- Fuel pressure — Check if fuel pressure remains normal when racing.
- Enrich mixture — Enrich air-fuel ratio (CONSULT active test or disconnect pressure regulator vacuum hose).
— Disconnect engine temperature sensor and check for any change.
- Stop feedback — Perform by CONSULT active test mode
OR
— Disconnect exhaust gas sensor connector and check for change.
- If any change is noted, check the fuel system (fuel pump, sensor system or clogging in the system).
- Inj clogging — Clean with engine conditioner.
- Idle judgement — Is throttle sensor OFF when accelerating?

IGNITION TIMING

- Is ignition timing normal?
- Knock control — Check if detonation sensor error is indicated by self-diagnosis.

(13) Poor driveability.....Lack of output, poor acceleration, poor response.
--

[Analysis]

Lack of power, poor acceleration and poor responses are generally caused by insufficient mixture quantity (lack of fuel, lack of air) or incorrect air-fuel mixture ratio.

In the injection system, these problems are caused by lack of ignition energy or incorrect ignition timing.

Lack of compression pressure and excessive friction due to seizure in engine main body are also causes of these conditions.

[Chart]**MIXTURE AIR QUANTITY, AIR-FUEL RATIO**

- Fuel pressure — Check if fuel pressure drops during racing (check for clogging with fuel pump and fuel system).
- Enrich mixture — Enrich by CONSULT active test or disconnect pressure regulator vacuum hose.
- Stop feedback — Check for change by CONSULT active test or disconnect exhaust sensor connector.
- Injector clogging — Clean with engine conditioner (CONSULT active test or pour conditioner into fuel filter, start engine then race engine).
- Air flow meter — Check output voltage.
output

IGNITION SYSTEM

- Spark plug — Is plug gap normal?
- Ignition timing — Is ignition timing normal?
 - Check by advancing or retarding ignition timing angle.
 - Check detonation sensor for abnormality (self-diagnosis for harness disconnection and shorts).
- Ignition energy — Check ignition coil power voltage.
 - Check for any leak from high-tension cable.

ENGINE MAIN BODY

- Compression — Measure compression pressure (Also check valve timing, valve pressure seat contact, piston and rings).

(15) Engine stall while idling.

[Analysis]

Engine stall during idling may be caused by one of the following conditions. (check idling speed, and then check for misfiring).

- Improper idling speed.
- Improper AAC valve control (Check for delayed response).
- Excessively lean or rich mixture ratio.
- Ignition error.
- Poor connector contacts etc.
- Relation to electrical load ON-OFF.

[Chart]

SELF-DIAGNOSIS

— Check if occurrence of error is stored by self-diagnosis function.

IDLING CONTROL

Correct control —

- Is idling speed normal or adjusted?
- Is AAC valve fully closed? (Check for loose connector).
- Close AAC valve fully and check for any change.
- Is AAC valve control signal issued?
(Race engine and check voltage).
- Is AAC valve operation normal? (CONSULT active test).
- Disconnect AAC valve connector and check by adjusting IAS.
- Check if idle judgement is ON.

AIR-FUEL RATIO

Air-fuel ratio — Check if exhaust gas temperature warning lamp (control unit red lamp) will flash more than five times in ten seconds when engine is running at 2,000 rpm, or check by CONSULT data monitor.

Enrich mixture — Perform CONSULT active test or disconnect pressure regulator vacuum hose.

Lean mixture — Perform CONSULT active test or apply vacuum greater than -500mmHg with hand pump to pressure regulator.

Stop feedback — Perform CONSULT active test.
OR
— Disconnect exhaust gas sensor (Set circuit from racing mode one time and return to idling mode).

Fuel pump — Check for pump stop.

Fuel system clogging — Race engine and check fuel pressure for drop.

OTHER

Poor contact — Using real-time diagnosis mode, check ignition signal, crank angle sensor signal and air flow meter signal for instantaneous break and missing pulses. (Use CONSULT data mode or oscilloscope).

Spark plug — Check for fouling and plug gap.

(16) Engine stall while driving.

[Analysis]

Engine stall during cruising may be caused by misfiring. If engine stalls during acceleration, it may be caused by misfiring or insufficient torque.

- Too rich or lean air-fuel mixture.
- Ignition error.
- Incorrect ignition timing.
- Insufficient intake air quantity.
- Insufficient compression pressure.
- Misfiring, fuel pump stop, etc. caused by poor electrical contact.

[Chart]**SELF-DIAGNOSIS**

————— Check if occurrence of error is stored by self-diagnosis function.

(1) When cruising**AIR-FUEL RATIO**

Throttle valve switch — Check if idle judgement goes OFF at correct time.

Feedback — Check if exhaust gas temperature lamp (control unit red lamp) will flash more than five times in ten seconds when engine is running at 2,000 rpm, or check by CONSULT data monitor.

Stop feedback — Perform CONSULT active test. OR
 — Disconnect exhaust gas sensor connector.

Intake air quantity sig — Check for poor contact by CONSULT data monitor (real-time diagnosis).

IGNITION

Ignition timing — Is ignition timing correct?

Ignition misfiring — Check ignition signal, crank angle sensor signal for missing pulses in CONSULT data monitor.

(2) During acceleration**AIR-FUEL RATIO**

Throttle valve switch — Check if idle judgement goes ON-OFF when acceleration pedal is pressed and released (CONSULT data monitor).

Throttle sensor — Check if voltage output varies with throttle opening.

Feedback — Check if exhaust gas temperature lamp (control unit red lamp) will flash more than five times in ten seconds when engine is running at 2,000 rpm, or check by CONSULT data monitor.

Stop feedback — Perform CONSULT active test. OR
 — Disconnect exhaust gas sensor connector.

Intake air quantity — Check for poor contact by CONSULT data monitor.
 — Check for air flow or leak after turbocharger operation.

MISFIRING

Ignition timing — Check if ignition timing is normal.

Ignition misfiring — Check ignition signal and crank angle sensor signal for missing pulses in CONSULT data monitor.

(17) Engine stall when decelerating or immediately after stopping.

[Analysis]

Reduced engine rpm when releasing accelerator pedal can lead to engine stall. Another cause is misfiring.

- Incorrect adjustment of idling control.
- Incorrect air-fuel ratio.
- Ignition error.

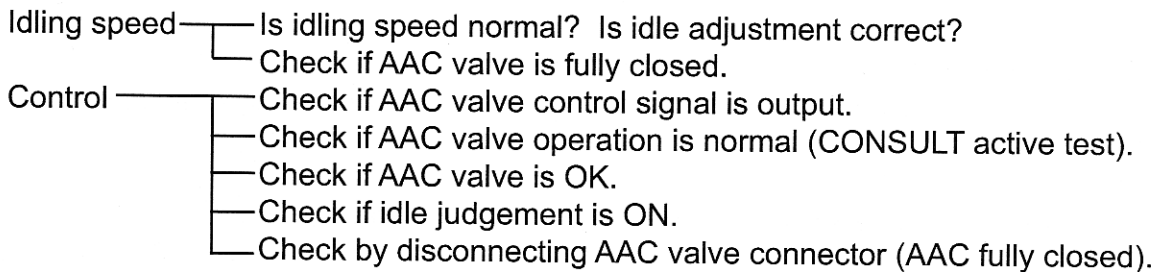
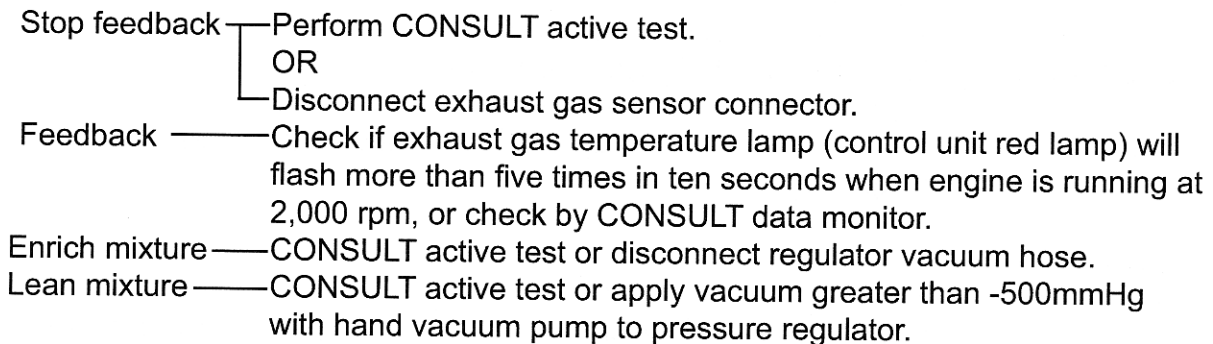
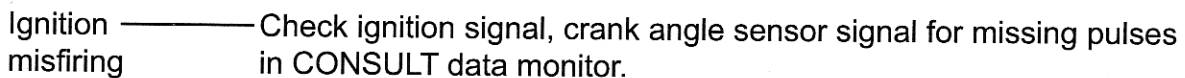
[Chart]**IDLE CONTROL****AIR-FUEL RATIO****IGNITION****ENGINE . A/T FUSION CONTROL**

(18) Engine stall when electrical load or power steering load is applied.

[Analysis]

Check if idling is increased when load switch is turned ON (AAC valve correction quantity increases when load is applied).

- Check if ON signal is input from each switch.
- Check if AAC valve is operating.

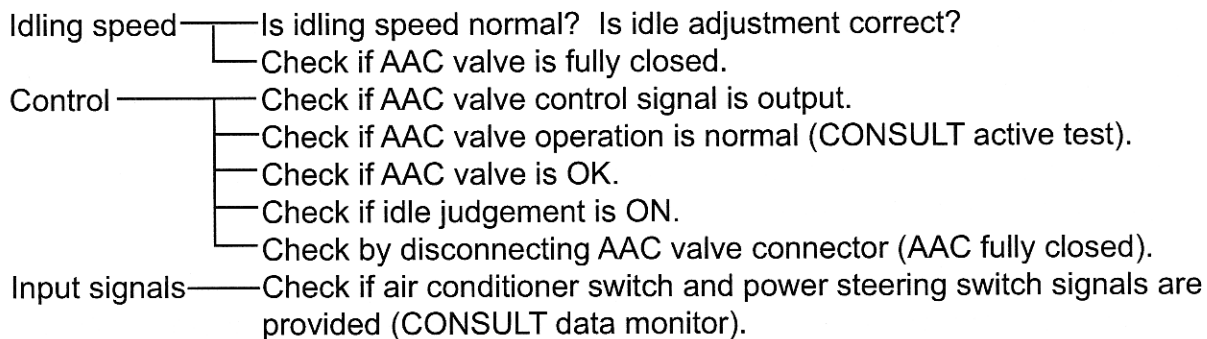
[Chart]**IDLE CONTROL**

3. DIAGNOSTIC SYSTEM

General

The performance of the diagnostic system has improved greatly with warning indication to drivers, operation of the self-diagnostic system and application of the newly developed electrical system diagnostic tester CONSULT.

Enhanced fault warning items

In cases when a fault occurs in the ECCS system while driving, the exhaust temperature warning lamp will flash in the instrument panel to warn a driver. At the same time, the back up function will activate to ensure the safety of occupants and the vehicle.

Simplified trouble-shooting strategy

The following features have been incorporated for simplifying inspection and problem diagnosis of the ECCS system.

Improvement of self-diagnostic function

The diagnostic modes have been rearranged and the mode shift and display system have been simplified.

Diagnostic mode		Mode selection	Display
1	Fault warning	By diagnostic connector installed near the fuse box (also adjustable by ECCS C/U adjustment volume knob)	Indicated by exhaust gas temperature warning lamp (Also linked with ECCS C/U red lamp)
2	O ₂ sensor monitor		
	Self-diagnosis		
Switch "ON/OFF" diagnosis and real time diagnosis are included in the operations performed by CONSULT as explained in item 2 on the following page.			

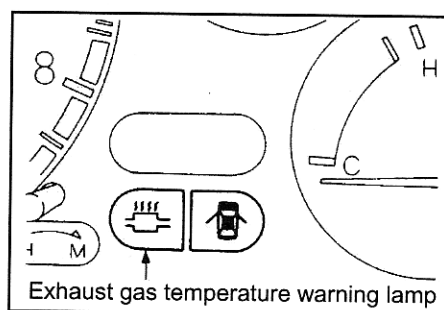
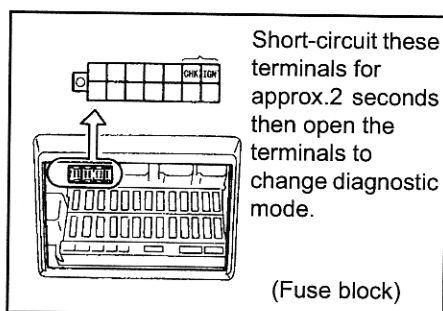

Introduction of electronic system diagnostic tester for fault diagnosis

To enable use of newly developed electronic system diagnostic tester CONSULT, the diagnostic function have been modified. Using the CONSULT will simplify complex diagnostic procedures.

CONSULT is a hand held type compact and light weight type tester device especially designed for automotive service operations. It can be used by connecting it to the diagnostic connector installed on the vehicle. This tester can permit data display, recording and printing.

MODE	DESCRIPTION	MODE SELECTION	DISPLAY
Function test	<ul style="list-style-type: none"> • OK or NG can be determined for each system as a basic inspection 	Modes can be selected by touch-sensitive keys on CONSULT	Displayed data can be read on the CONSULT screen
Self-diagnosis	<ul style="list-style-type: none"> • Self-diagnosis 		
Data monitor	<ul style="list-style-type: none"> • Used to identify major causes of fault according to result from self-diagnosis. • Input and output data from ECCS C/U can be monitored and printed. • Data can be recorded at the time of engine faults or stall. • The following items are included in this monitor item: O₂ sensor monitor Switch ON/OFF Real time diagnosis 		
Active test	<ul style="list-style-type: none"> • Used to examine major causes of faults from self-diagnosis result and data monitor. • Used to check actuator operation by giving drive signal to actuator. 		
Operation support	<ul style="list-style-type: none"> • Used to reduce additional operation when checking idling etc. 		

4. SELF-DIAGNOSIS

Self-diagnosis can be performed by indications from warning lamp (exhaust gas temperature warning lamp) in the instrument panel display and ECCS control unit red lamp display or by displaying data on the CONSULT screen.

Engine warning lamp display

There are two diagnostic modes. In each mode diagnosis is performed by operating the diagnostic connector terminal installed on the vehicle. (Diagnosis can also be performed by using the adjustment knob on the control unit). The diagnosis results are displayed by exhaust gas temperature warning lamp in the combination meter and the red warning lamp on the control unit.

Basic operation and display

ITEM		OPERATION	DISPLAY
Mode 1	Fault warning	Ignition switch "ON" ↓ Engine rev	Alarm: Faulty system indicated by warning lamp flashing Normal: Warning lamp remains OFF
Mode 2	Self-diagnosis	Ignition switch "ON" ↓ Diagnosis mode shift ↓ Engine stop (with ignition switch "ON" position)	Faulty: Faulty system is indicated by flashing code Normal: Flashing code "55" displayed
	O ₂ sensor monitor	Self-diagnosis status described above ↓ Engine rev	Lamp ON: Lean Lamp OFF: Rich

(1) Fault warning mode (mode 1) Operation and display

OPERATION	DISPLAY			
<ul style="list-style-type: none"> Place ignition switch to ON position. Mode 1 is usually set by this operation. [Pay attention to the following as the following can also happen: If the ignition switch is turned OFF in the self-diagnosis mode and then turned ON few seconds later, the self-diagnosis mode will be selected. In this case, the diagnosis mode must be changed (see item (2))] 	Indicated by exhaust gas temperature warning lamp and ECCS C/U red lamp (these lamps are connected).			
		Engine rev	Display	Condition
	Warning	Stop	ON (lamp check)	-
		Rev	Flashing	CPU back up (lamp flashes when engine has stopped)
	Normal	Stop	ON (lamp check)	-
		Rev	OFF	-

(2) Fault warning mode (mode 2)**Operation and display**

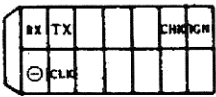
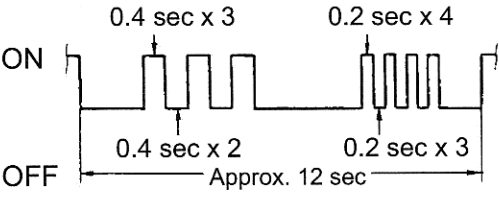
OPERATION	DISPLAY
<ul style="list-style-type: none"> Place ignition switch to ON position. Normally fault warning mode is set when ignition switch is turned ON. It is necessary to select diagnostic mode. Short-circuit. "CHK" and "IGN" terminals connected on the diagnosis connector located on the vehicle (inside fuse box) for approx. 2 sec. then separate the terminals. (Diagnosis connector)  <p>(The fault warning mode and self-diagnosis mode alternate each time the operation is performed).</p> <ul style="list-style-type: none"> Stop the engine (Ignition switch in ON position). If the engine is operated in this condition the monitor will change to next mode O₂ sensor monitor. 	<p>Indicated by exhaust gas temperature warning lamp in instrument panel and red lamp in control unit (these lamps are linked together).</p> <p>Example: Indication of code number "43".</p> 

(Reference)

Name of diagnosis connector terminals

CHK: Diagnosis start (Check)

IGN: Ignition power supply

CLK: Transmission synchronization signal (clock)

RX: ECCS C/U data reception

TX: ECCS C/U data transmission

-: Earth

Diagnosis item

CODE No.	DIAGNOSIS ITEM	ERROR (CODE NO.) STATE
11	Crank angle sensor signal system	<ul style="list-style-type: none"> 1° and 120° signal is not input for a certain period of time after starting the engine. Incorrect signal waveform (abnormal linkage between 1° and 120° signal).
12	Air flow meter signal system	<ul style="list-style-type: none"> Hot wire disconnection. Disconnection or short-circuit in air flow meter power supply, earth or signal system. Signal output is below 1V for a certain period of time during engine operation. Signal output is over 2V for a certain period of time at engine stall or when ignition switch is in OFF to ON.
13	Engine coolant temperature sensor signal system	<ul style="list-style-type: none"> Disconnection or short-circuit in engine coolant temperature sensor signal system.
21	Ignition signal system	<ul style="list-style-type: none"> Ignition signal is not generated even though the crank angle sensor signal is entered.
34	Knock sensor signal system	<ul style="list-style-type: none"> Disconnection or short-circuit in knock sensor.
43	Throttle sensor signal system	<ul style="list-style-type: none"> Disconnection or short-circuit in throttle sensor.
54	A/T transmission system	<ul style="list-style-type: none"> Disconnection or short-circuit in A/T transmission system.
55	No error	<ul style="list-style-type: none"> No abnormality found in any of above signal system.

To erase memory

Stop the engine in mode 2 and short-circuit the terminal "CHK" and "IGN" of the diagnostic connector for over 2 seconds. Then OPEN to erase every diagnosis item.

(3) O₂ sensor monitor mode (mode 2)**Operation and display**

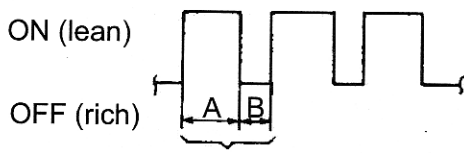
OPERATION	DISPLAY
<ul style="list-style-type: none"> Place ignition switch in the "ON" position. At this time check the mode is in "Self-diagnosis" mode. If in "Fault warning" mode, short-circuit "CHK" and "IGN" terminals for approx. 2 seconds then OPEN to change the mode. Rev the engine. <p><u>Caution:</u> The mode cannot be changed when the engine is running.</p>	<p>Indication is made by the warning lamp (exhaust temperature warning lamp) and ECCS C/U red lamp.</p> <ul style="list-style-type: none"> During air-fuel ratio feedback control. <ul style="list-style-type: none"> OFF: O₂ sensor output is 'RICH' ON: O₂ sensor output is 'LEAN' <p>(Reference) The lamp ON and OFF indication is the same as that of the air-fuel ratio feed back correction coefficient indicated by the red lamp in the former control unit.</p> <ul style="list-style-type: none"> Air-fuel ratio feedback control is clamped: Status immediately before clamping is maintained. Air-fuel ratio feedback control is faulty: OFF <p>Example:</p>  <p>1 cycle duty ratio $\left\{ \begin{array}{l} \text{Lean: } A/A+B \times 100 \\ \text{Rich: } B/A+B \times 100 \end{array} \right.$</p> <p>The status of air-fuel ratio is indicated by the duty ratio in one cycle.</p>

FAIL-SAFE FUNCTION AND BACK UP FUNCTION

Fail-safe function ensures the safety of the driver and the vehicle by using the control unit control signals in case of an error in an important system device.

The back up function ensures normal vehicle operation when an error occurs in an important sensor. The control unit will ignore the signal sent from a failed sensor and outputs prearranged control signals.

The fault alarm mode is set when the back up function is operating, and the exhaust gas temperature warning lamp will flash in the instrument panel to warn the driver.

ITEM	FAULT DESCRIPTION	FAIL-SAFE OR BACK UP	WARNING DISPLAY
CPU back up	Error detected in ECCS C/U internal circuit	<ul style="list-style-type: none"> Fix ignition timing at set value Fix fuel injection at start, idling and driving 	<ul style="list-style-type: none"> Exhaust temperature warning lamp turns on Decrease vehicle speed at CPU back up
Crank angle sensor back (RB20E only)	When crank angle sensor signal (1° or 120°) is not displayed for over 3 seconds when engine is started	<ul style="list-style-type: none"> Fix ignition timing at set value 	('11' is indicated in self-diagnosis mode)
Air flow meter	Intake air quantity signal is disconnected during engine operation	<ul style="list-style-type: none"> Fix fuel injection pulse width at set value Fuel cut at 2000rpm 	('12' is indicated in self-diagnosis mode)
Engine coolant temperature sensor	Short-circuit or disconnected	<ul style="list-style-type: none"> Enable normal driving 	('13' is indicated in self-diagnosis mode)
Knock sensor	Short-circuit or disconnected	<ul style="list-style-type: none"> Maximum 5° engine is delayed in knock control area. 	('34' is indicated in self-diagnosis mode)
Throttle sensor	Short-circuit or disconnected	<ul style="list-style-type: none"> Enable normal driving 	('43' is indicated in self-diagnosis mode)
AAC valve	At idling condition (idle sw 'ON', neutral sw 'ON', vehicle speed below 8km/h) the engine rev is extremely high (target rev + over 700rpm)	<ul style="list-style-type: none"> Fuel cut (Cut and recovery, idle hunting is repeated) 	-

ECCS C/U INPUT AND OUTPUT SIGNAL MODE APPLICATION

MODE		Function test	Self-diagnosis	Data monitor	Active test	Operation support
INPUT	Crank angle sensor		●	●		
	Air flow meter		●	●		
	Engine coolant temp sensor		●	●	●	
	Vehicle speed sensor	●		●		
	Battery voltage			●		
	Idle SW	●		●		
	Throttle sensor	●		●		●
	Idle determination (Throttle sensor)	●	●	●		
	Knock sensor		●			
	Ignition (START) signal	●		●		
	Air conditioner, neutral, power steering oil pressure SW	●		●		
	O ₂ sensor			●		
	OUTPUT	Fuel injector			●	
Ignition signal		● (Ignition timing)	●	● (Ignition timing)	● (Ignition timing)	
AAC valve		●		●	●	●
Air conditioner relay				●		
Fuel pump relay		●		●	●	●
Power balance		●			●	

5. CONSULT

Connect CONSULT to diagnosis connector on the vehicle (inside the fuse box). Data is displayed on the CONSULT screen as touch-sensitive keys. The exhaust gas sensor monitor, switch ON / OFF operation and real-time diagnosis are performed using data monitor mode.

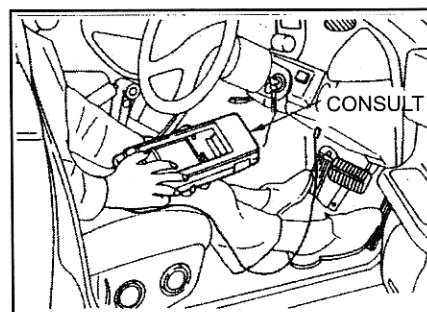

FUNCTION TEST

This is a basic fault diagnosis. CONSULT will diagnose each system and displays OK or NG in the monitor.

TEST ITEM	DESCRIPTION
Self-diagnosis result	Output self-diagnosis result
Idle determination	Diagnose idle switch by fully opening or closing the accelerator pedal
Throttle sensor	Diagnose throttle sensor system by fully opening or closing the accelerator pedal
Neutral SW	Diagnose neutral switch system by moving the select lever
Fuel pump	Diagnose fuel pump system by checking the fuel pressure pulsation when the fuel tube is connected
Starter signal	Diagnose starter signal system by starting the engine. Also displays the battery voltage, average battery voltage while cranking, engine coolant temperature, cranking rev and air flow meter output voltage.
Power steering signal	Diagnose power steering signal system by rotating and straightening the steering wheel.
Vehicle speed sensor	Diagnose vehicle speed sensor system when the vehicle speed is over 10 km/h.
Ignition timing test	Reads ignition timing using timing light. Ignition timing is diagnosed by corresponding read value with set value.
Base air-fuel ratio test	Diagnose air-fuel ratio from O ₂ sensor output and feed back system (fuel injection control, ignition timing control, vacuum system etc.) when at 2000rpm with no load.
Power balance	Diagnose combustion condition of each pipes by stopping each injector pipes one at a time and checking the change in engine rev.
AAC valve	Diagnose AAC valve system by checking the change in engine rev when AAC valve opening is 0%, 20% and 80%.

Caution:

There is no OK or NG display for the fuel pump and ignition timing diagnosis. It is the checker's decision to determine OK or NG.

Operation and display

OPERATION	DISPLAY EXAMPLE
<ul style="list-style-type: none"> • Connect CONSULT to vehicle diagnosis connector. • Place ignition switch to ON position or rev the engine. • Select "Function test" on touch-sensitive screen. • Select "Program mode" or "Manual mode" and carry out diagnosis. <p>Follow the procedure on the CONSULT screen.</p>	

Caution:

If diagnosis connector is removed while carrying out the function test, the mode will remain in 'Function test mode' until the ignition switch is placed in OFF position.

SELF-DIAGNOSIS MODE

Diagnosis item is same for (1) and (2). It will be displayed in faulty system name.

Operation and display

OPERATION	DISPLAY EXAMPLE
<ul style="list-style-type: none"> • Connect CONSULT to vehicle diagnosis connector. • Place ignition switch to ON position (engine stopped). • Inspect in "Self-diagnosis result". • To print touch 'Print' key. • To erase memory touch 'Erase' key. 	

DATA MONITOR

The data monitor can be utilized when performing troubleshooting or trouble diagnosis according to self-diagnosis result. CONSULT will monitor and print the ECCS C/U input and output signal data.

Monitoring items and description

MONITORING ITEM	UNIT	DESCRIPTION	COMMENT
CAS.RPM (POS)	rpm	Engine rev calculated from crank angle sensor signal	System decrease when below idle rev
AIR FLOW MTR	V	Air flow meter output voltage	Voltage is set at approx. 0V when engine is stopped
ENG COOLANT TEMP SEN	°C	Converted into temperature from engine coolant temperature sensor output voltage	Fail-safe is activated when short-circuited or disconnected and temperature is set at set value
O ₂ SENSOR	V	O ₂ sensor output voltage	Set at 0V when engine is stopped
O ₂ SEN MTR	(RICH/LEAN)	A/F ratio of O ₂ sensor signal during A/F ratio feedback control RICH: Detects rich mixture and control is operated to reduce mixture ratio LEAN: Detects lean mixture and control is operated to increase mixture ratio	When clamped, the status just before clamping is indicated
VEHICLE SPEED SEN	km / h	Value calculated from vehicle speed sensor signal	-
BATTERY VOLT	V	ECCS C/U power voltage	-
THROTTLE SEN		Throttle sensor output voltage	-
STARTER SIG	(ON / OFF)	ON/OFF setting is determined from each signal output	OFF is displayed irrespective of starter signal after starting engine
IDLE DETERMINATION			Determined by throttle sensor output
AIR CON SIG			-
NEUTRAL SW			
POWER STEERING SIG			
INJ PULSE	msec	Value computed by control unit	Set value is displayed when engine is stopped
IGNITION TIMING	BTDC		
AAC VALVE	step	Value computed by control unit '%': proportional solenoid system	
A/F RATIO CORRECTION	%	Mean value of A/F ratio feedback correction factor for each cycle	Set value is displayed when engine is stopped
AIR CON RELAY	(ON / OFF)	Control condition computed by ECCS control unit	
FUEL PUMP RELAY			
PWR VOLTAGE	Displays measured value of probe voltage		
PULSE	Displays measured value of pulse probe		

Operation and display

OPERATION	DISPLAY EXAMPLE
<ul style="list-style-type: none"> • Connect CONSULT to vehicle diagnosis connector. • Run the engine or drive the vehicle. • Select item in "Data monitor". • Select "START monitoring" key. 	<div data-bbox="828 227 1203 467" style="border: 1px solid black; padding: 5px;"> <p>★MONITORING★ NO FAULT <input type="checkbox"/></p> <p>CAS.RPM(REF) 850rpm</p> <p>AIR FLOW MTR 1.58v</p> <p>ENG COOLANT TEMP SEN 68°C</p> <p>O2 SEN 1.17V</p> <p>O2 SEN MONITOR RICH</p> <p>VEH SPEED SEN 0km/h</p> <p>BATTERY VOL 14.0V</p> <p>STARTER SIG OFF</p> </div> <div data-bbox="828 471 1203 519" style="border: 1px solid black; text-align: center; padding: 5px;"> <p>START MONITORING</p> </div> <div data-bbox="828 552 1203 792" style="border: 1px solid black; padding: 5px;"> <p>★MEMORIZING 5/8★ NO FAULT <input type="checkbox"/></p> <p>CAS.RPM (REF) 850rpm</p> <p>AIR FLOW MTR 1.57V</p> <p>ENG COOLANT TEMP SEN 69°C</p> <p>O2 SEN 1.18V</p> <p>O2 SEN MONITOR RICH</p> <p>VEH SPEED SEN 0km/h</p> <p>BATTERY VOL 14.0V</p> <p>STARTER SIG OFF</p> </div> <div data-bbox="828 797 1203 845" style="border: 1px solid black; text-align: center; padding: 5px;"> <p>STOP MONITORING</p> </div>

O₂ SENSOR MONITOR

O₂ sensor output voltage and "RICH" or "LEAN" is displayed.

Operation and display

OPERATION	DISPLAY EXAMPLE
<ul style="list-style-type: none"> • Connect CONSULT to vehicle diagnosis connector. • Run the engine or drive the vehicle. • Select 'O₂ sensor monitor' or 'O₂ sensor' in "Data monitor" to carry out inspection. • Select "STAR MEMORIZING" key to memorize. 	<div data-bbox="828 1242 1203 1482" style="border: 1px solid black; padding: 5px;"> <p>★MONITORING★ NO FAULT <input type="checkbox"/></p> <p>O2 SENSOR 1.19V</p> <p>O2 SENSOR MONITOR RICH</p> </div> <div data-bbox="828 1487 1203 1535" style="border: 1px solid black; text-align: center; padding: 5px;"> <p>START MONITORING</p> </div>

SWITCH ON / OFF

The ON / OFF status of each switch is indicated.

Operation and display

OPERATION	DISPLAY EXAMPLE
<ul style="list-style-type: none"> • Connect CONSULT to vehicle diagnosis connector. • Run the engine or drive the vehicle. • Select each switches in "Data monitor". • Set operating condition for applicable switch and check ON / OFF display. 	<div style="border: 1px solid black; padding: 5px;"> <p>★MONITORING★NO FAULT <input type="checkbox"/></p> <p>STARTER SIGNAL OFF</p> <p>IDLE DETERMINATION ON</p> <p>AIR COND SIGNAL OFF</p> <p>NEUTRAL SW ON</p> <p>POWER STEERING SIG OFF</p> </div> <div style="border: 1px solid black; padding: 5px; margin-top: 5px;"> <p>START MONITORING</p> </div>

Diagnosis items

- Ignition switch "start" signal system
- Throttle sensor signal system
- Neutral switch signal system
- Power steering switch signal system
- Air conditioner switch signal system
- Fuel pump signal system

REAL - TIME DIAGNOSIS

Although the diagnosis items are the same as those listed in self-diagnosis switch ON / OFF mode, this diagnostic mode provides higher detection capability than self-diagnosis mode for the crank angle sensor, air flow meter, ignition primary signal and the fuel pump.

Operation and display

OPERATION	DISPLAY EXAMPLE
<ul style="list-style-type: none"> • Connect CONSULT to vehicle diagnosis connector. • Inspect using the "DATA MONITOR" real-time diagnosis mode. 	<div style="border: 1px solid black; padding: 5px;"> <p>◆ REAL-TIME DIAG ◆ <input type="checkbox"/></p> <p>ENG COOLANT TEMP SENS</p> </div> <div style="border: 1px solid black; padding: 5px; margin-top: 5px;"> <p>DATA MEMORIZED</p> </div> <div style="border: 1px solid black; padding: 5px; margin-top: 5px;"> <p>MEMORY 2 DATA DISPLAY</p> </div>

ACTIVE TEST

The active test mode is used to examine the problem diagnosis according to self-diagnosis results and data monitor results. CONSULT will give driving signals to the actuator while isolating the on-board ECCS C/U to check if the actuator is functioning properly.

Monitoring items and description

MONITORING ITEMS	DESCRIPTION
Fuel injection	Changes air - fuel ratio
AAC valve opening	Sets control value (opening)
Engine coolant temperature	Sets engine coolant temperature
Ignition timing	Sets delay angle correction value
Power balance	Fixes AAC valve opening degree and stops specified injector operation. It will display the current engine rev.
Fuel pump relay	Turns ON / OFF
Self-learning cont	Clears leaned air-fuel ratio feedback correction factor.

Operation and display

OPERATION	DISPLAY EXAMPLE						
<ul style="list-style-type: none"> • Connect CONSULT to vehicle diagnosis connector. • Run the engine or drive the vehicle. • Select item in "Active test". • Touch "START" key to set the value. 	<div style="border: 1px solid black; padding: 5px; width: fit-content; margin: auto;"> <div style="display: flex; justify-content: space-between; align-items: center;"> ◆ ACTIVE TEST ◆ <input type="checkbox"/> </div> <p>ENG COOLANT TEMP SEN 20°C</p> <p>-----</p> <table style="width: 100%; border-collapse: collapse;"> <tr> <td style="width: 70%;">CAS.RPM(POS)</td> <td style="text-align: right;">800rpm</td> </tr> <tr> <td>INJ PULSE</td> <td style="text-align: right;">3.7msec</td> </tr> <tr> <td>IGN timing</td> <td style="text-align: right;">15BTDC</td> </tr> </table> <div style="display: flex; justify-content: space-around; margin-top: 5px;"> Qu UP DOWN Qd </div> </div>	CAS.RPM(POS)	800rpm	INJ PULSE	3.7msec	IGN timing	15BTDC
CAS.RPM(POS)	800rpm						
INJ PULSE	3.7msec						
IGN timing	15BTDC						

OPERATION SUPPORT

CONSULT can be used as an aid for idling checks and other engine tune-up operations. If an instruction is sent to ECCS C/U, it will perform control and displays the input and output signal data being used. The actual tune-up operation must be performed manually by a mechanic (for example, tuning adjustment screw etc.)



Support items and description

OPERATION SUPPORT ITEMS	DESCRIPTION
AAC valve adjustment	Fully closes AAC valve and display idle rev
Throttle sensor (installation position) adjustment	Displays throttle sensor output voltage when the throttle valve is fully closed

6. BASIC INSPECTION (RB20E / RB26DETT)

A

Switches input signal inspection

- Select the following switches in the "DATA MONITOR" mode. 
- a) Start signal
- b) Idling
- c) Air conditioner signal
- d) Neutral switch
- e) Power steering signal
- Check ON / OFF switch operation.
- Connect a check adapter between ECCS C/U and the harness connector and use volt meter to inspect ON / OFF switch operation. 

Start signal
 Ignition sw ON: Approx. 0V
 Ignition sw START: Power vol

Idling (after engine warm up)
 Idling: Approx. 0.4V
 Accel fully open: Approx. 3.8V

Air conditioner signal
 A/C OFF: Power voltage
 A/C ON: Approx. 0V

Neutral SW
 Neutral: 0V
 Not neutral: Approx. 4.5V

Power steering signal
 Not steered: Approx. 4.5V
 Steered: Approx. 0V

NG
 Replace or repair if fault is detected.

A

☆ MONITORING ☆	NO FAULT	
STARTER SIG	OFF	
IDLING	OFF	
AIR CON SIG	OFF	
NEUTRAL SW	ON	
POWER ST SIG	OFF	
PWR LOAD SIG	OFF	
START MONITORING		

A

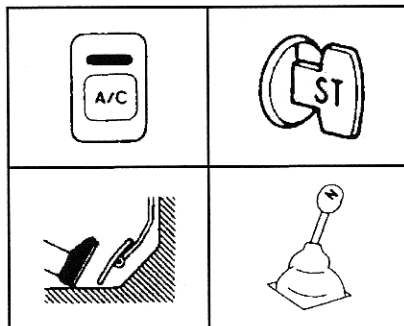

B

◆ SELF-DIAGNOSIS ◆	<input type="checkbox"/>
RESULT	
FAULTY SYSTEM	TIME
ENG COOLANT TEMP SEN	0
ERASE	PRINT

B

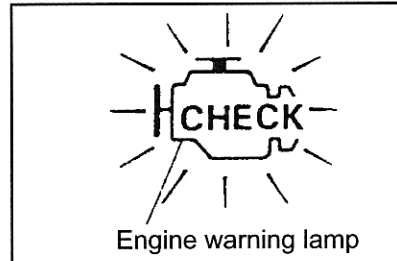

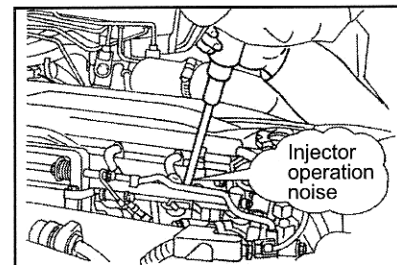

C



B

OK

Self-diagnosis result confirmation

- Operate self-diagnosis mode 
- Confirm self-diagnosis result.
- Set to "Self diagnosis mode" (mode 2). 
- Check the code number using engine warning lamp flashes.

NG
 Carry out necessary inspection

C

OK

Injector operation inspection

Place a sound scope or screwdriver on the injector and check for injector operation noise (tick, tick, tick) while cranking.



NG
 Inspect inj control circuit

OK

TO D

D

Fuel pump operation inspection

- Select "Fuel pump relay" in active test. Check for operation noise when "START" is selected. 
- Check for fuel pump operation noise for 5 sec after turning ignition switch to ON position. 

NG

Inspect fuel pump control circuit

D

◆ ACTIVE TEST ◆

FUEL PUMP RELAY ON

MONITORING



CAS.RPM (POS) 0rpm

START INTERMIT STOP

E

OK

Fuel pressure inspection

- Select "Fuel pump" in function test. Check for pulsation on the fuel hose. 
- Pinch the hose between fuel filter and the fuel gallery while fuel pump is operating and check for tension or pulsation. 

NG

Inspect fuel hose for clogs, bent or torsion

D

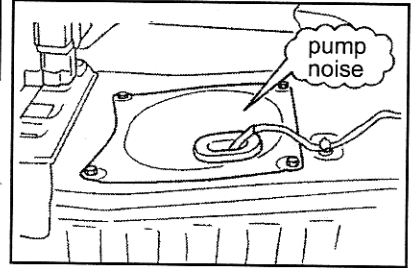

E

◆ FUEL PUMP ◆

CAN YOU FEEL A PULSE EVERY 3 SECONDS OR CAN YOU HEAR FUEL PUMP RELAY OPERATION NOISE?

PASS NO YES

OK
FINISH

E

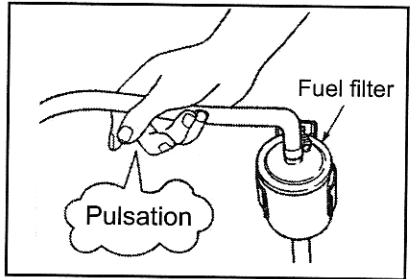

6. BASIC INSPECTION (RB25DE / RB25DET)

A

Before engine start

- Look for fault indication and check recent service record.
- Check the following in the engine bay:
 - Is harness connector connected?
 - Are there any cracks or torsion on vacuum hose? connected correctly?
 - Is harness connected correctly with no disconnection.

A

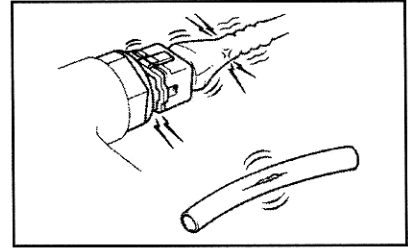

B

Connect CONSULT

Connect diagnosis connector to CONSULT and place ignition switch to ON position. Select "ENGINE" from the item menu.

B

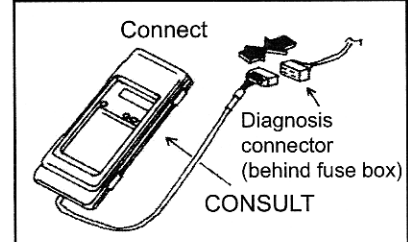

C

Does the engine start? NG To E

C

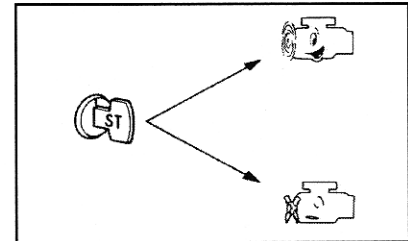

D

Idle adjustment screw primary stage set up revolution inspection

- Select "AAC valve adjustment" in "Operation support" mode.
- Check that engine rpm will drop to 600 ~ 700 rpm when "START" is pressed (N range).
- Check that engine rpm will drop to 600 ~ 700 rpm when ECCS C / U adjustment volume is turned right until it stops.

NG

OK

For engine rpm adjustment use idle adjustment screw.

D

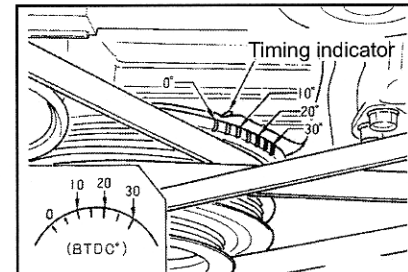

D

★MONITORING★NO FAUL	
CAS.RPM (POS)	787rpm
CAR SPD SEN	0km/h
START MONITORING	

E

Ignition timing inspection

After warming up the engine, idle the engine and inspect the ignition timing using timing light. For more information refer to "Idle rev, ignition timing, air-fuel ratio inspection" section earlier in the manual.

Ignition timing (BTDC°) : 13 ~ 17°

NG

TO F

Rotate crank angle sensor to adjust ignition timing.

E

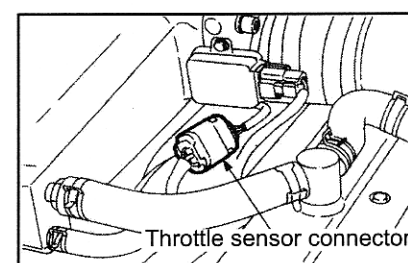

F

Throttle sensor idle position inspection

- Select "THROTTLE SENSOR ADJ" from operation support mode.
- Check that throttle sensor output voltage is approx. 0.4 ~ 0.5V (fully closed) and Idle position is ON.
- Use voltmeter to measure throttle sensor output voltage. Make sure it is between approx. 0.4 ~ 0.5V (fully closed).

F

◆ THROTTLE ADJ ◆

ADJ MONITOR
THROTTLE SENS 0.40V

MONITOR
CAS.RPM (REF) 0rpm
IDLE ON

G

OK

Switches input signal inspection

- Select the following switches in the "DATA MONITOR" mode.
- Start signal
- Idling
- Air conditioner signal
- Neutral switch
- Power steering signal
- Check ON / OFF switch operation.

- Connect a check adapter between ECCS C/U and the harness connector and use volt meter to inspect ON / OFF switch operation.

Start signal

Ignition sw ON: Approx. 0V
Ignition sw START: Power voltage

Idling (after engine warm up)

Idling: Power voltage
Accelerator fully open: Approx. 0V

Air conditioner signal

A/C OFF: 7.0~10.0V
A/C ON: 0.5~0.7V

Neutral SW

Neutral: 0V
Not neutral: 8.0~10.0V

Power steering signal

Not steered: Approx. 8V
Steered: Approx. 0V

F

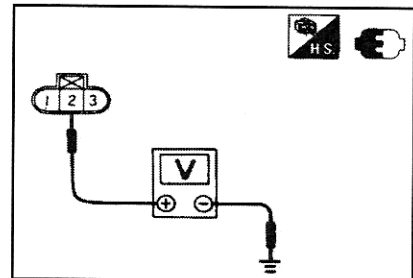

G

☆ MONITOR ☆ NO FAULT

STARTER SIG OFF
IDLE ON
A/C SIG OFF
NEUTRAL SIG ON
P/S SIG OFF

START MONITORING

G

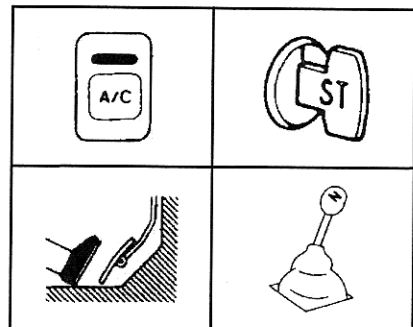

H

OK

Self-diagnosis result confirmation

- Operate self-diagnosis mode.
- Confirm self-diagnosis result.
- Set to "Self diagnosis mode" (mode 2).
- Check the code number using engine warning lamp flashes.

NG

OK

TO I

Carry out necessary procedure

H

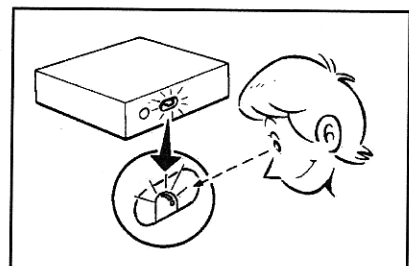

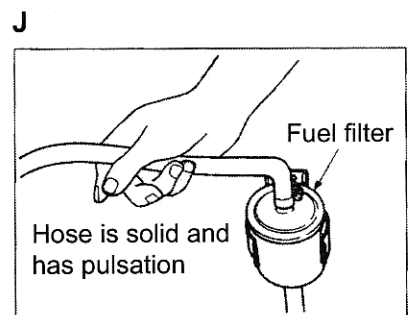
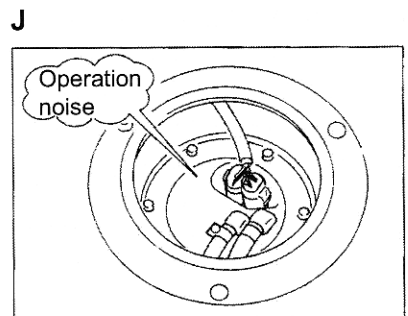
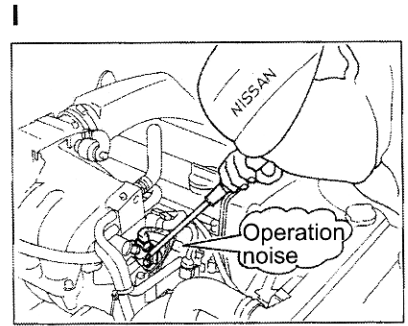
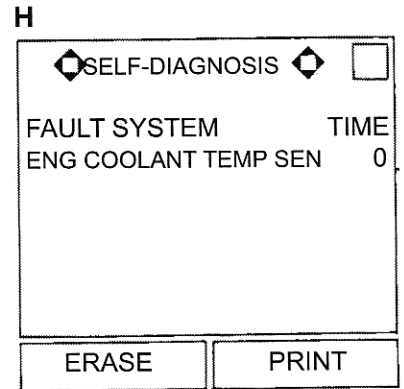
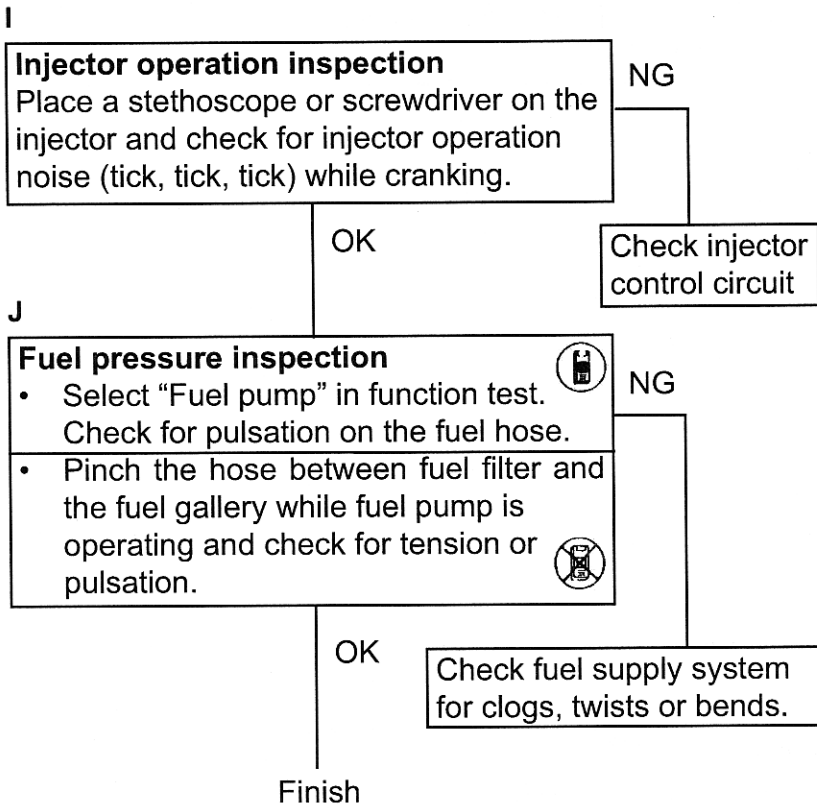

EN7 FAULT DIAGNOSIS BY SELF-DIAGNOSIS SYSTEM

1. POWER SUPPLY AND EARTH CIRCUIT

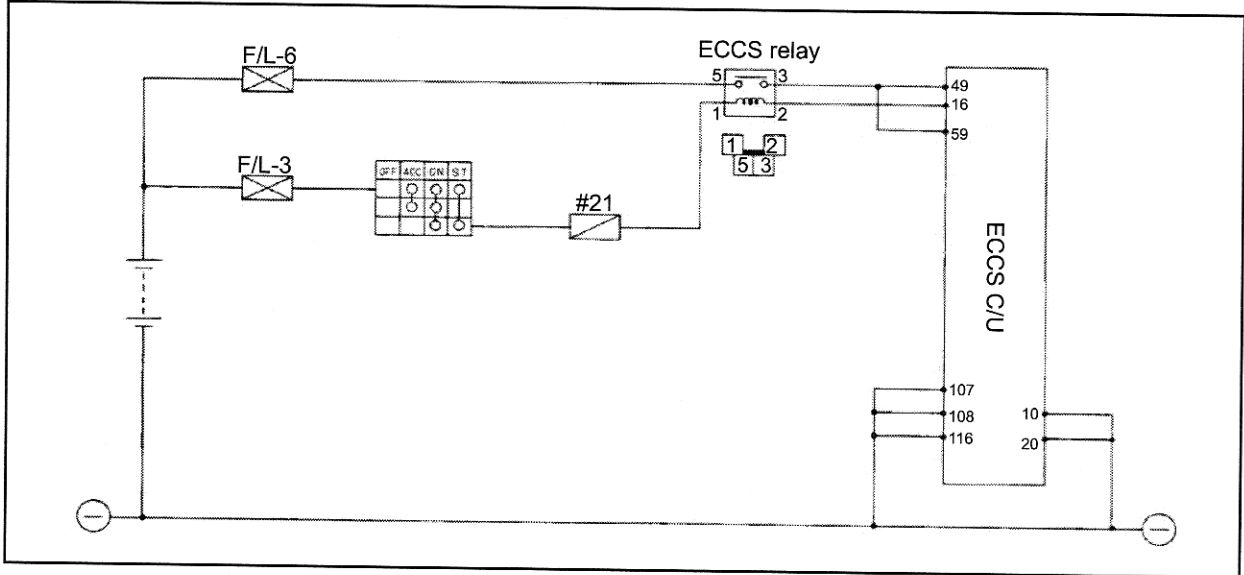

A

Power supply inspection

- Place ignition switch in the ON position.
- Check power voltage using "battery voltage" in data monitor mode.
- Use tester to measure power voltage between ECCS C/U terminal 49, 50 and body earth.

OK

A

☆ MONITORING ☆ NO FAULT

CAS.RPM (POS)	1062rpm
POWER VOL	14.0V

START MONITORING

B

Ground circuit inspection

- Place ignition switch to OFF position. Remove ECCS C/U harness connector.
- Check for harness continuity between ECCS C/U terminal 10, 20, 107, 108, 116 and body earth.

If NG repair faulty harness or connectors.

NG

A

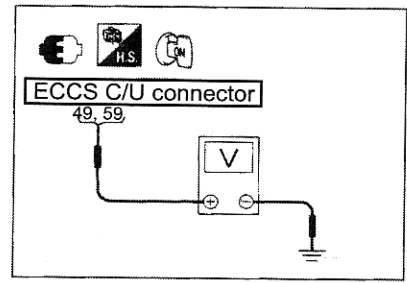

FINISH

B

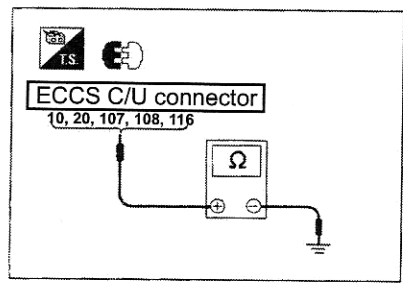

C

Harness continuity inspection

- Place ignition switch to OFF position.
- Disconnect ECCS C/U and ECCS relay harness connector.
- Check for continuity between ECCS C/U terminal 49, 59 and ECCS relay terminal 3.

NG

OK

Faulty harness or connector.

TO D

D

Voltage inspection between ECCS C/U terminal and earth

- Place ignition switch to ON position.
 - Measure power voltage between ECCS relay terminal 2, 3 and earth.
- If NG place ignition switch to OFF position. Inspect the continuity between ECCS relay and the battery.

NG

OK

Repair faulty harness or connector.

E

Output signal circuit inspection

Check for continuation between ECCS C/U terminal 16 and terminal 1.

NG

OK

Inspect the following:
Ignition coil harness connector.
Harness between ECCS C/U and ECCS relay.
If NG repair faulty harness or connector.

Component parts inspection

- Check ECCS relay.

NG

OK

Repair ECCS relay

Inspect ECCS C/U terminal for any damage and ECCS C/U connector connections.

C

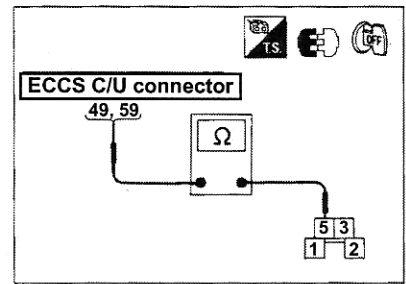

D

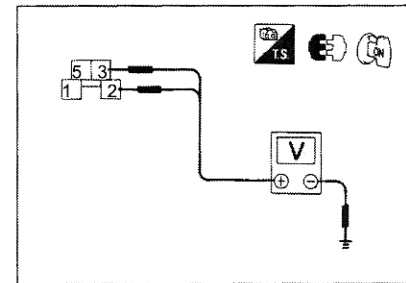

E

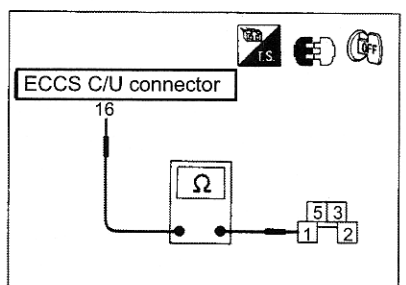

2. CRANK ANGLE SENSOR SYSTEM (SELF-DIAGNOSIS DISPLAY 11)

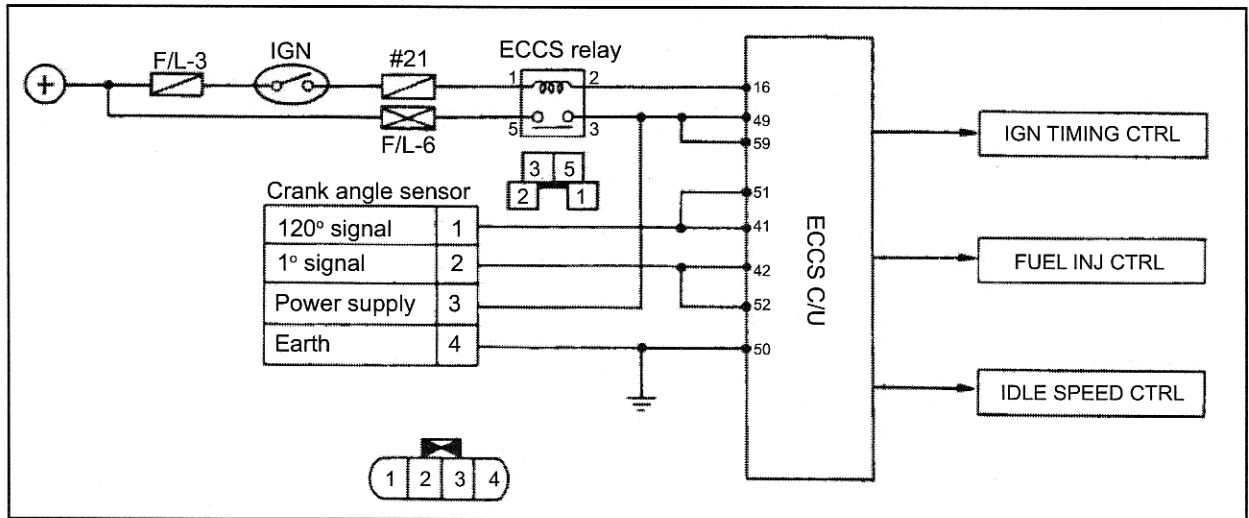

A

Power supply inspection

- Place ignition switch to OFF position.
- Remove crank angle sensor harness connectors.
- Place ignition switch in the ON position.
- Use tester to measure the voltage between terminal 3 and body earth.

NG

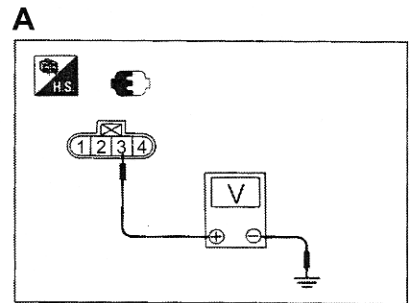

OK

Inspect the following:
 Check the continuity between crank angle sensor terminal 3 and ECCS relay terminal 3.
 If NG repair faulty harness or connectors.

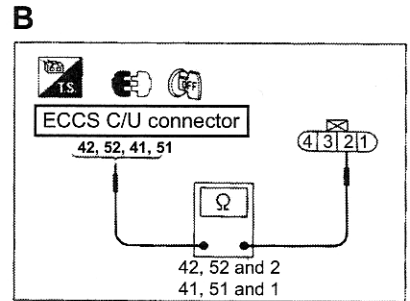

B

Input signal circuit inspection

- Place ignition switch in the OFF position.
- Disconnect ECCS C/U harness connectors.
- Check for continuity between crank angle sensor terminal 2 and ECCS C/U terminal 42, 52 (1° signal), between crank angle sensor terminal 1 and ECCS C/U terminal 41, 51 (120° signal).

NG



OK

Repair faulty harness or connector

TO C

C

Input signal inspection

- Connect crank angle sensor and ECCS C/U harness connectors.
- Use "CAS. RPM" in data monitor mode to measure engine speed. 
- Measure the voltage between ECCS C/U terminal 41, 42, 52, 51 and ground. 

Voltage	Terminal 42, 52	Terminal 41, 51
Ignition sw ON	0V or approx.5V	0V or approx.5V
Cranking	Approx. 5V	Approx. 2 ~ 3V
Idling	Approx. 0.3~0.7V	Approx. 2 ~ 3V

OK

Component parts inspection

- Check crank angle sensor.
- If NG replace crank angle sensor.

Inspect ECCS C/U terminal for any damage and ECCS C/U connector connections.

NG

C

☆MONITORING ☆NO FAULT	
CAS.RPM (REF)	662rpm
AIR FLOW MTR	1.02V
ENG TEMP SEN	81°
EXH SEN	0.18V
THROTTLE SEN	0.38V
INJ PULSE	3.0msec
START MONITORING	

C

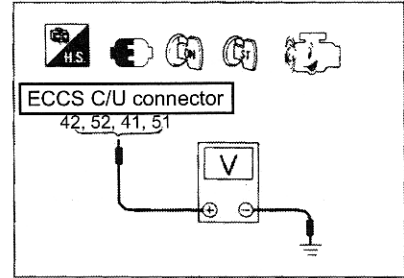

3. AIR FLOW METER SYSTEM (SELF-DIAGNOSIS DISPLAY 12)

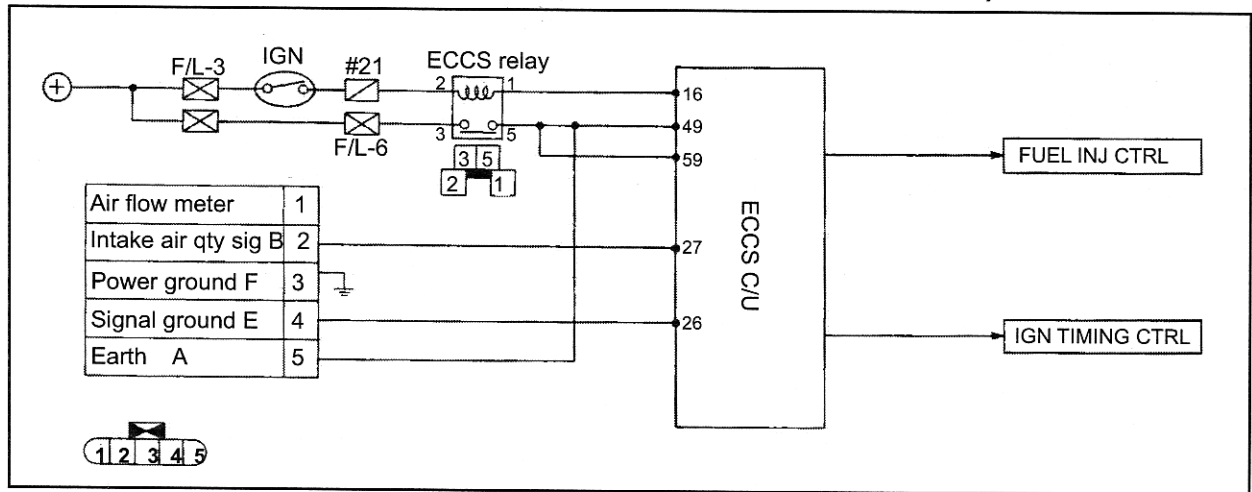

A

Power supply inspection

- Place ignition switch in the OFF position.
- Remove air flow meter harness connector.
- Place ignition switch in the ON position.
- Use tester to measure the voltage between terminal 3 and body earth.

A

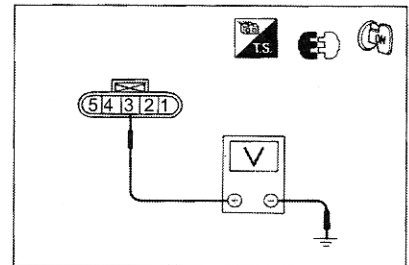

OK

Inspect the following:

- Check for continuity between air flow meter terminal 5 and ECCS relay terminal 3.

If NG repair harness or connectors.

B

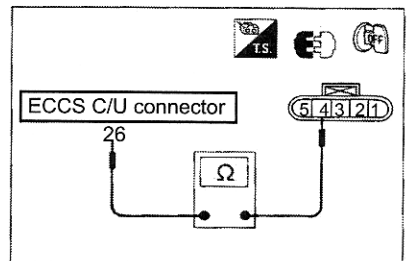

B

Ground circuit inspection

- Place ignition switch to OFF position.
- Remove ECCS C/U harness connectors.
- Check for continuity between terminal 4 and ECCS C/U terminal 26.

C

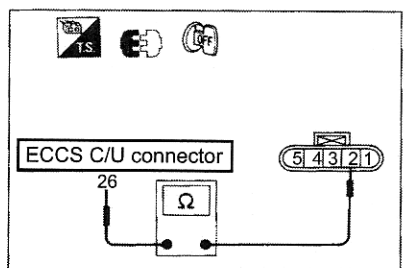

OK

Repair harness or connector.

C

Input signal inspection

Check for continuity between air flow meter terminal 2 and ECCS C/U terminal 27 (intake air quantity signal).

NG



Repair harness or connector.

OK

TO D

D

Input signal inspection

- Connect air flow meter and ECCS C/U harness connectors.
- Use "AIR FLOW METER" in data monitor mode to measure input signal. 
- Measure the voltage between ECCS C/U terminal 27 and body earth. 

Voltage	Terminal 27
Ignition sw in ON	Approx. 0.3V
Cranking	Approx. 1V
Idling	Approx. 1.1V

NG

OK

Component parts inspection

- Check air flow meter.
- If NG replace air flow meter.

Inspect ECCS C/U terminal for any damage and ECCS C/U connector connections.

D

☆ MONITORING ☆ NO FAULT

CAS.RPM (REF)	662rpm
AIR FLOW MTR	1.02V
ENG TEMP SEN	81°C
EXH SEN	0.18V
THROTTLE SEN	0.40V
INJ PULSE	3.0msec

START MONITORING

D

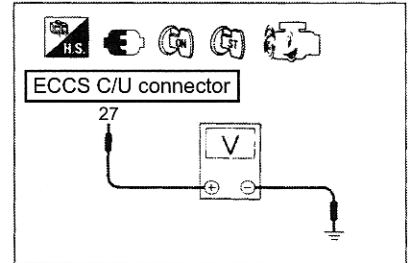

4. WATER TEMPERATURE SENSOR SYSTEM (SELF-DIAGNOSIS DISPLAY 13)

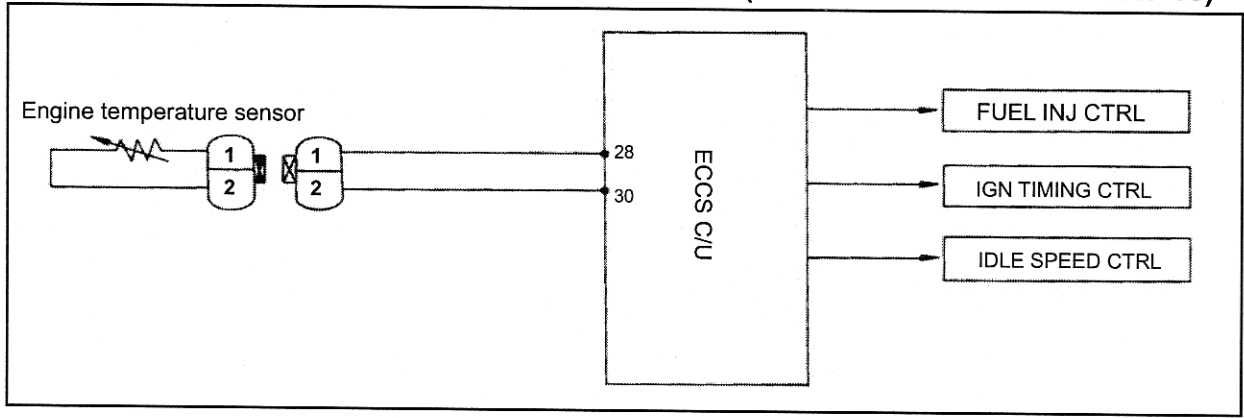

A
Power supply inspection

- Place ignition switch in the OFF position.
- Remove engine temperature sensor harness connector.
- Place ignition switch in the ON position.
- Use tester to measure power voltage between terminal 1 and body earth.
Voltage: Approx. 5V

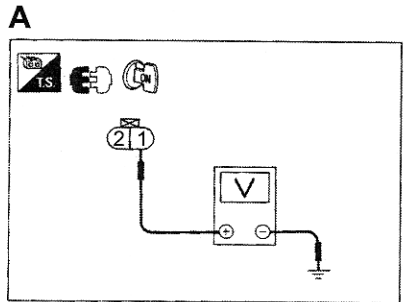

OK

Repair faulty harness or connector.

NG

B
Earth circuit inspection

- Place ignition switch in the OFF position.
- Check for continuity between terminal 2 and body earth.

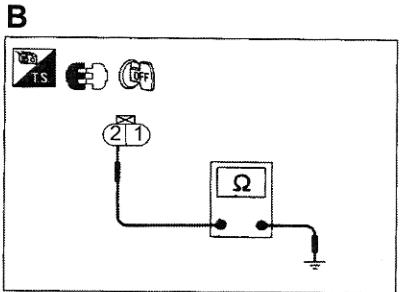

OK

Repair faulty harness or connector.

NG

C
Input signal inspection

- Use "ENG TEMP SENSOR" in data monitor mode to check engine coolant temperature.
- Check the power voltage between ECCS C/U terminal 28 and earth.
Ignition switch in ON position

Eng temp Approx. 20°C:	3V
Approx. 80°C:	1V

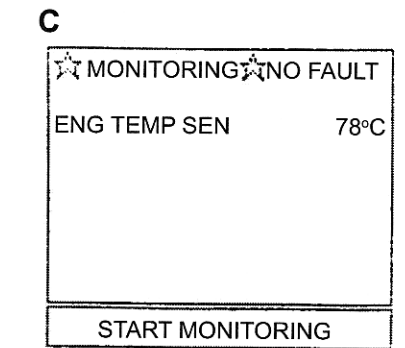

OK

Component parts inspection

- Check water temperature sensor. If NG replace crank angle sensor.

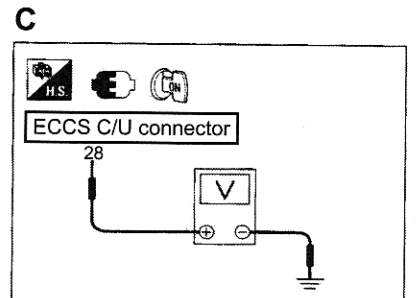

Inspect ECCS C/U terminal for any damage and ECCS C/U connector connections.

5. IGNITION SYSTEM (SELF-DIAGNOSIS DISPLAY 21)

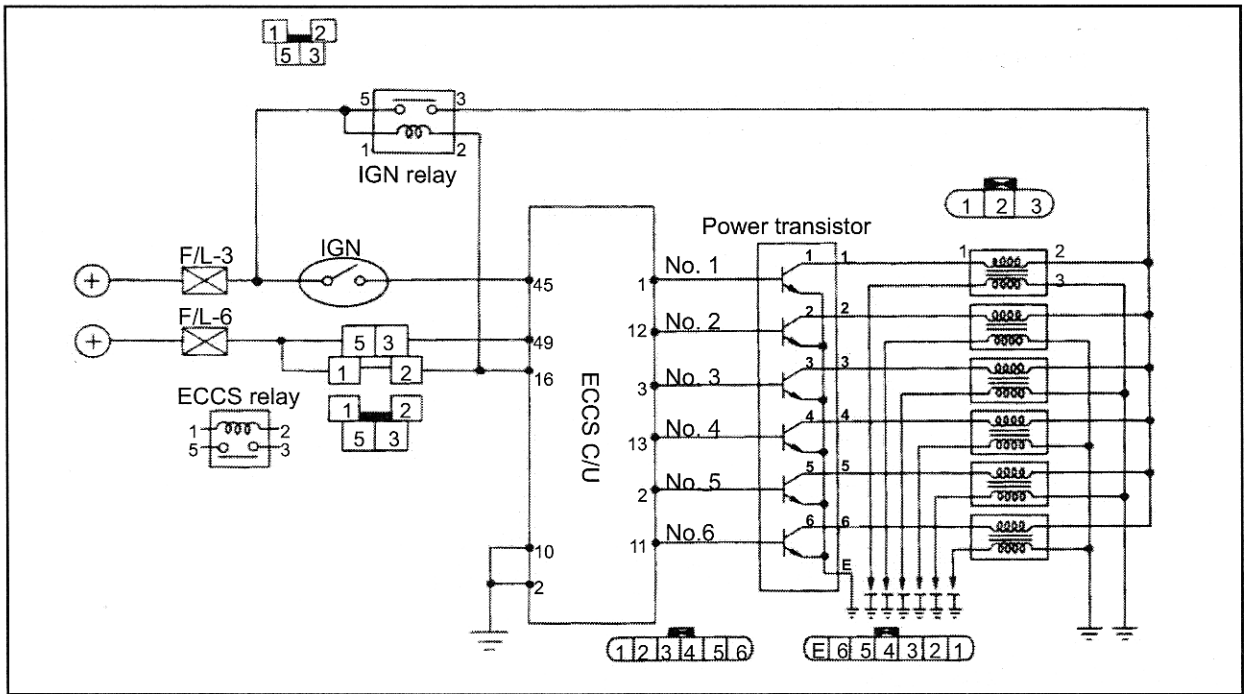

A

Circuit function inspection

- Inspect using "Power balance" in function test mode.
- Check if engine rev will decrease momentarily.

OK

B

Earth circuit inspection

- Place ignition switch to OFF position.
- Remove power transistor unit harness connector.
- Check for harness continuity between terminal E and earth.

OK

NG

Repair faulty harness or connector

TO C

A

◆ SELF-DIAG RES ◆

FAILURE DETECTED TIME
IGN SIGNAL PRIMARY 0

ERASE PRINT

A

◆ POWER BALANCE ◆

INSPECT THE BALANCE OF EACH CYLINDER BY STOPPING INJECTOR OPERATION FOR EACH CYLINDER.

PASS START

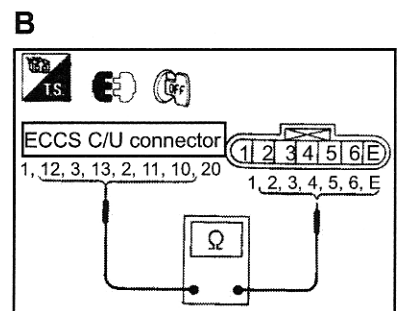

C**Output signal circuit inspection**

- Place ignition switch to OFF position.
- Remove ECCS C/U harness connector.
- Check for continuity between following terminals:

ECCS C/U terminal 1 & 2
 ECCS C/U terminal 12 & 2
 ECCS C/U terminal 3 & 3
 ECCS C/U terminal 13 & 4
 ECCS C/U terminal 2 & 5
 ECCS C/U terminal 11 & 6
 ECCS C/U terminal 10 & E
 ECCS C/U terminal 20 & E

NG

OK

Repair faulty harness or connector.

D**Output signal inspection**

- Connect power transistor unit and ECCS C/U harness connectors.
- Check for power voltage between ECCS C/U terminals 1, 2, 3, 11, 12, 13 and body earth.

Cranking: Approx. 0.2 ~ 0.3V
 Idling: Approx. 0.2 ~ 0.3V
 2500rpm: Approx. 1V

NG

OK

Repair faulty harness or connector.

Component parts inspection

- Check power transistor unit.
- If NG replace power transistor unit.

OK

Inspect ECCS C/U terminal for any damage and ECCS C/U connector connections.

6. O₂ SENSOR SYSTEM (SELF-DIAGNOSIS DISPLAY 15)

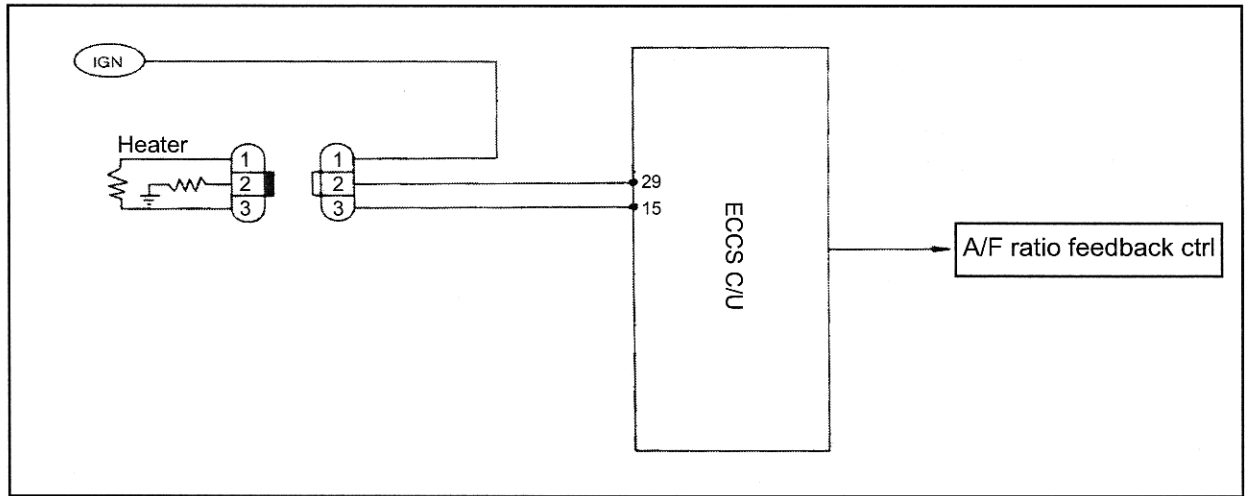

A

Function inspection - 1 

- Warm up the engine.
- Inspect using "Base air-fuel ratio" in function test mode.

OK → FINISH

B | NG

Function inspection - 2 

- Start the engine.
- Hold the engine at 2000 rpm and carry out inspection using "O₂ SENSOR" (output voltage and "O₂ SENSOR MONITOR" (lean, rich) in data monitor mode.

OK → FINISH

NG

- Measure the voltage between ECCS C/U terminal 29 and earth. 
- Approx. 0.3V (constant voltage): NG
- Approx. over 0.6 ~ 1V (variant voltage): OK

C | NG

Input signal circuit inspection

- Place ignition switch in the OFF position.
- Remove O₂ sensor harness connector and ECCS C/U harness connector.
- Check for continuity between ECCS C/U terminal 29 and O₂ sensor harness connector terminal 2.

OK → Replace O₂ sensor

NG → Repair faulty harness or connector

Inspect ECCS C/U terminal for any damage and ECCS C/U connector connections.

A

◆ BASE A/F RATIO TEST ◆

HOLD THE ENGINE SPEED AT 2000+/-200rpm AND PRESS START.

1800 2000 2200

PASS START

B

☆ MONITORING ☆ NO FAULT

CAS.RPM (REF)	650rpm
O2 SENSOR	0.02V
O2 SENSOR MTR	RICH

START

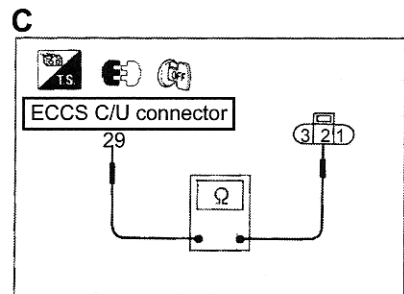
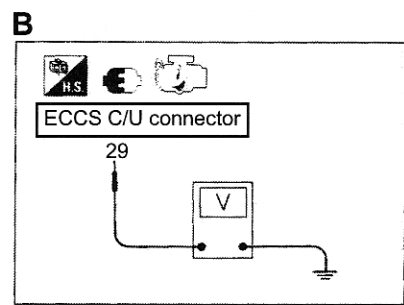

7. DETONATION SENSOR SYSTEM (SELF-DIAGNOSIS DISPLAY 34)

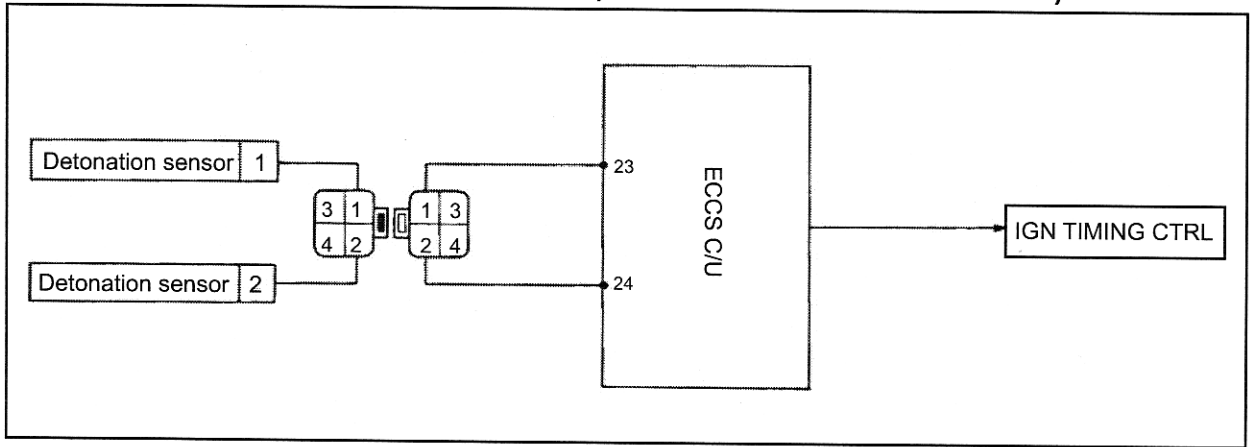

A

Input signal circuit inspection - 1

- Place ignition switch in the OFF position.
- Remove ECCS C/U harness connector and sub harness connector.
- Check for continuity between terminal 1 and ECCS C/U terminal 23, terminal 2 and ECCS C/U terminal 24.

OK

Repair faulty harness or connector

NG

A

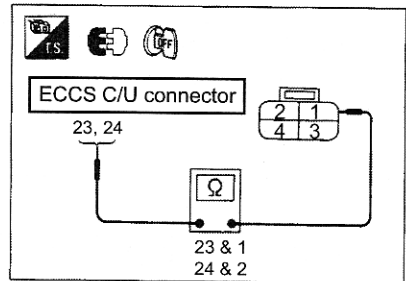

B

Input signal circuit inspection - 2

- Remove harness connectors connected at front & rear of the knock sensor.
- Check for continuity between sub harness terminal A and 23, B and 24.

OK

Repair faulty harness or connector

NG

B

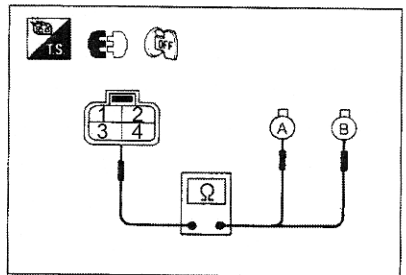

C

Input signal inspection

- Connect knock sensor and ECCS C/U harness connectors.
- Measure the voltage between ECCS C/U terminal 23, 24 and earth.

Voltage	Terminal 23, 24 and earth
Ignition in ON	Approx. 4V
Cranking	Approx. 4V
Idling	Approx. 4V

OK

Replace knock sensor

NG

Inspect ECCS C/U terminal for any damage and ECCS C/U connector connections.

8. THROTTLE SENSOR SYSTEM (SELF-DIAGNOSIS DISPLAY 43)

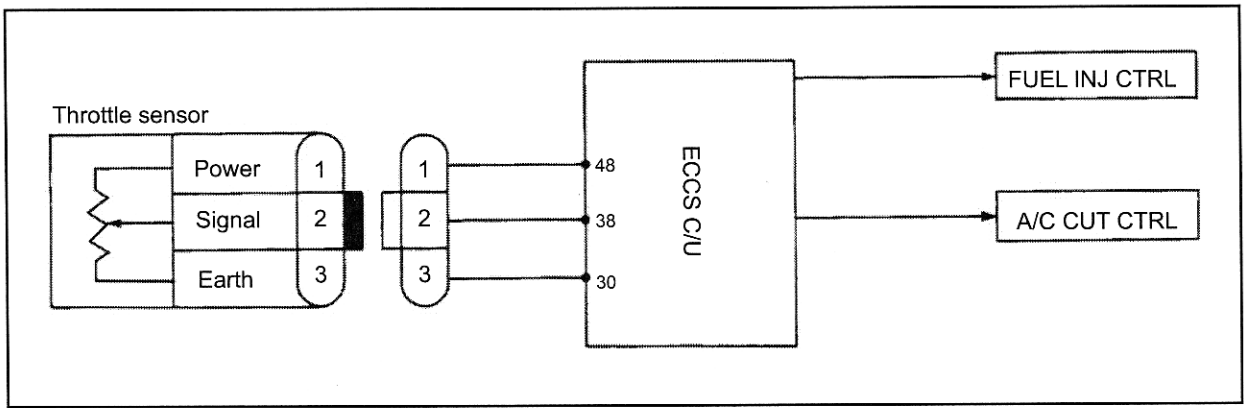

A

System inspection

- Place ignition switch in the ON position.
- Use "THROTTLE SENSOR" in data monitor mode to inspect the system.

Voltage

Fully open	Approx. 4.0V
Fully closed	Approx. 0.6V
Open / Close range over	Approx. 3.0

OK

FINISH

A

◆ THROTTLE SENSOR ◆

PRESS START WHILE DEPRESSING THE ACCELERATOR PEDAL FULLY.

PASS START

B

Power supply inspection

- Place ignition sw in the ON position.
- Use "THROTTLE SENSOR" in data monitor mode to carry out inspection.
- Place ignition sw in the OFF position.
- Remove throttle sensor harness connector. Measure the power voltage between terminal 1 and earth.

Power voltage: Approx. 5V

NG

Repair faulty harness or connector

B

☆ MONITORING ☆ NO FAIL

CAS.RPM (REF)	0rpm
THROTTLE SEN	3.94V

START

C

- Remove ECCS C/U harness connector.
- Check for continuity between ECCS C/U terminal 38 and 2.

NG

Repair faulty harness or connector

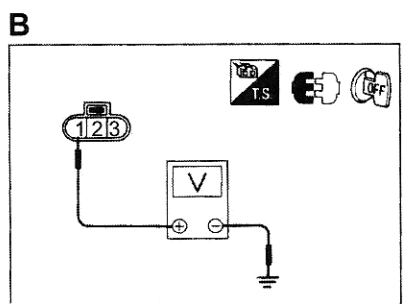

Component parts inspection

- Inspect throttle sensor.
- If NG replace throttle sensor unit.

OK

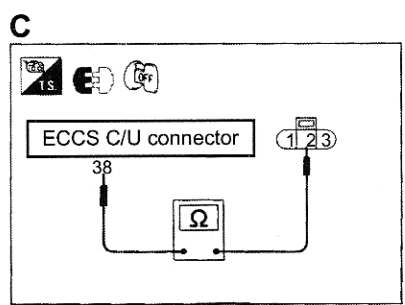

Inspect ECCS C/U terminal for any damage and ECCS C/U connector connections.

9. A/T CONTROL SYSTEM (SELF-DIAGNOSIS DISPLAY 54)

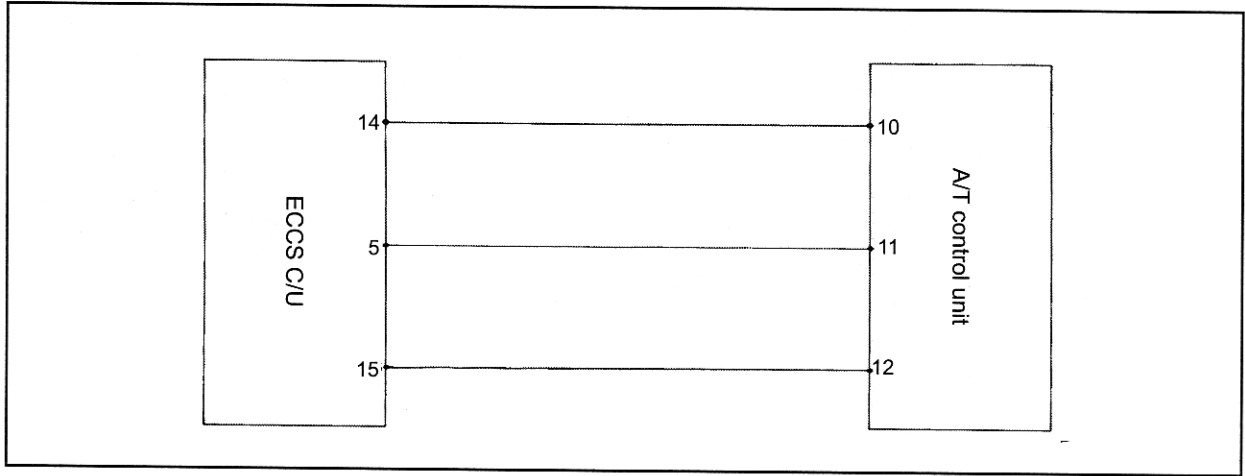

A

Input signal circuit inspection

- Place ignition switch in the OFF position.
- Remove ECCS C/U harness and A/T C/U harness connectors.
- Check the continuity between ECCS C/U terminal 14 and A/T C/U terminal 10, ECCS C/U terminal 5 and A/T C/U terminal 11.

NG

OK

Repair faulty harness or connector

Inspect ECCS C/U terminal for any damage and ECCS C/U connector connections.

A

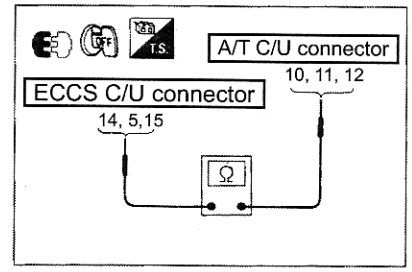

10. CRANK ANGLE SENSOR SYSTEM (NOT IN SELF-DIAGNOSIS)

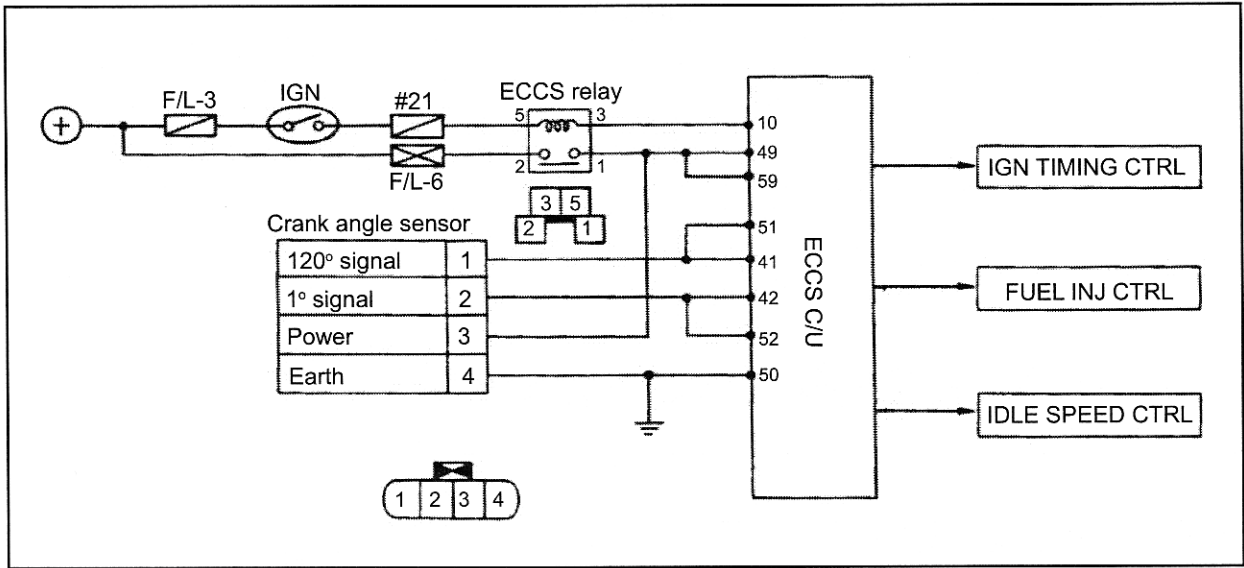

A

Earth circuit inspection

- Place ignition switch to OFF position.
- Remove crank angle sensor harness connector.
- Check for continuity between terminal 4 and body earth.

OK

Repair faulty harness or connector.

Component parts inspection

- Check crank angle sensor.
- If NG replace crank angle sensor.

NG

Replace crank angle sensor.

OK

Inspect ECCS C/U terminal for any damage and ECCS C/U connector connections.

A

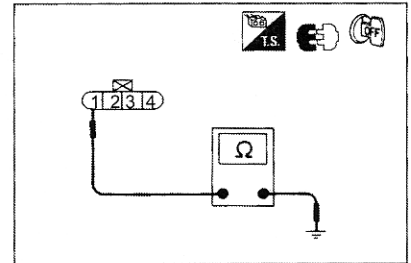

EN7 FAULT DIAGNOSIS BY SELF-DIAGNOSIS SYSTEM

1. POWER SUPPLY AND EARTH CIRCUIT

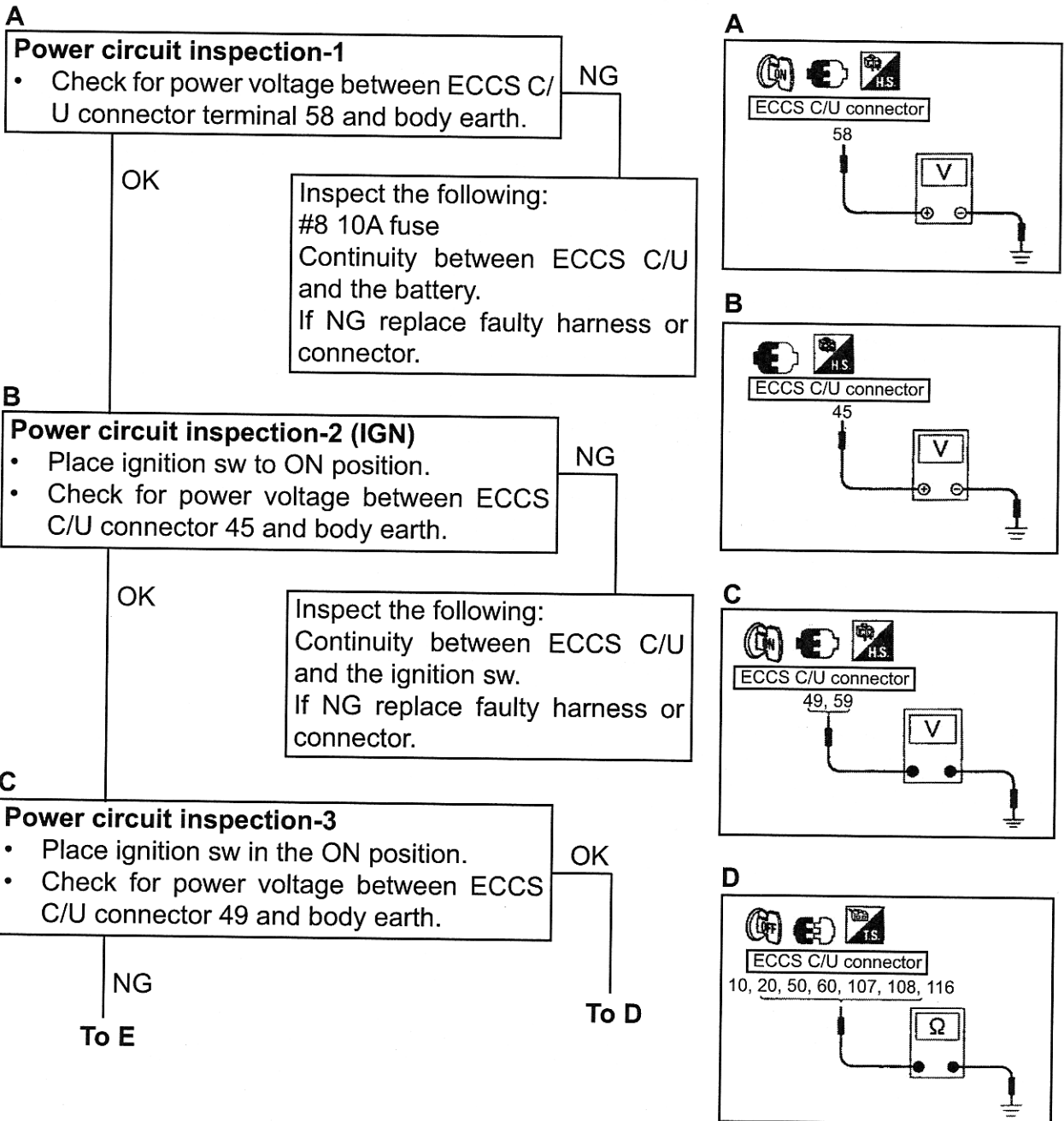
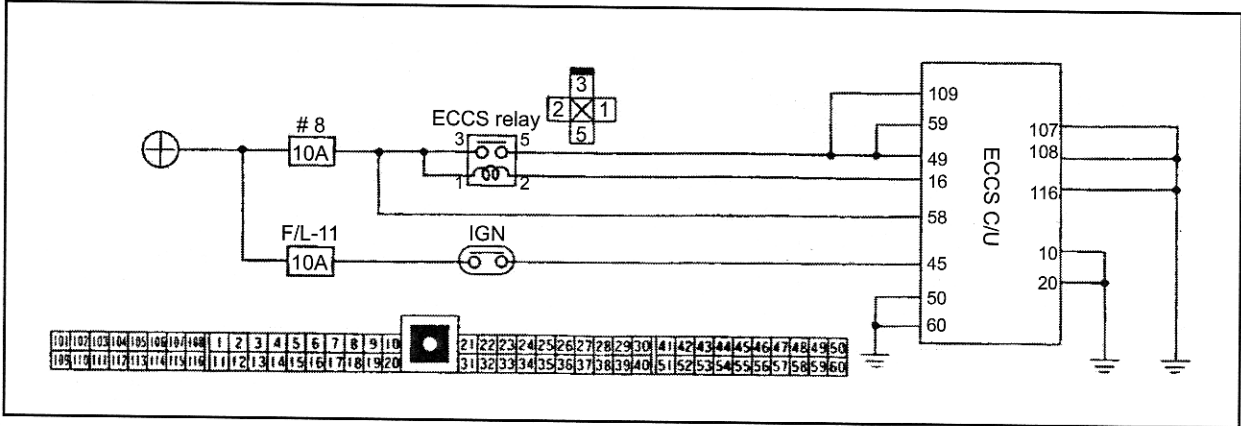

D

Ground circuit inspection

- Place ignition sw in OFF position.
- Remove ECCS C/U harness connector.
- Check for continuity between ECCS C/U harness connector 10, 20, 50, 60, 107, 108, 116 and body earth.

If NG faulty harness or connector.

E

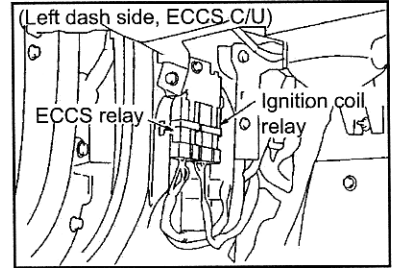

E

ECCS C/U and ECCS relay harness inspection

- Place ignition sw in the OFF position.
- Remove ECCS C/U connector.
- Remove ECCS relay harness connector.
- Check for continuity between ECCS C/U connector side terminal 49 & 59 ECCS relay harness connector terminal 5.

NG

Faulty harness or connector.

OK

E

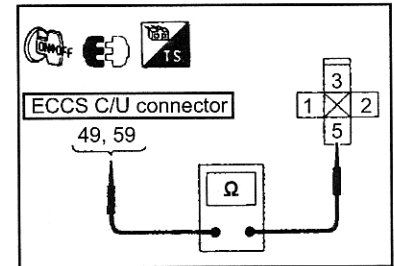

F

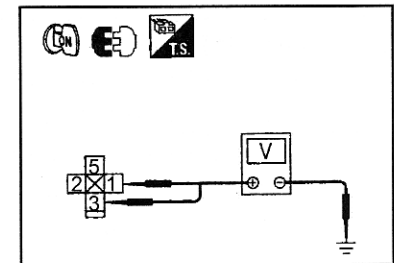

F

ECCS relay power supply inspection

- Check for power voltage between ECCS relay connector terminal 1 & 3 and body earth.

NG

Inspect the following:
Check for harness continuity between ECCS relay and the battery.
If NG replace faulty harness or connector.

OK

G

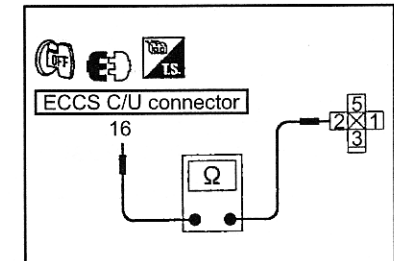

G

Output signal circuit inspection

- Check for continuity between ECCS C/U connector terminal 16 and ECCS relay harness connector terminal 2.

NG

Faulty harness or connector.

OK

Component parts inspection

- Check ECCS relay.

NG

Replace ECCS relay

OK

Inspect ECCS C/U terminal for any damage and ECCS C/U connector connections.

2. CRANK ANGLE SENSOR SYSTEM (SELF-DIAGNOSIS DISPLAY 11)

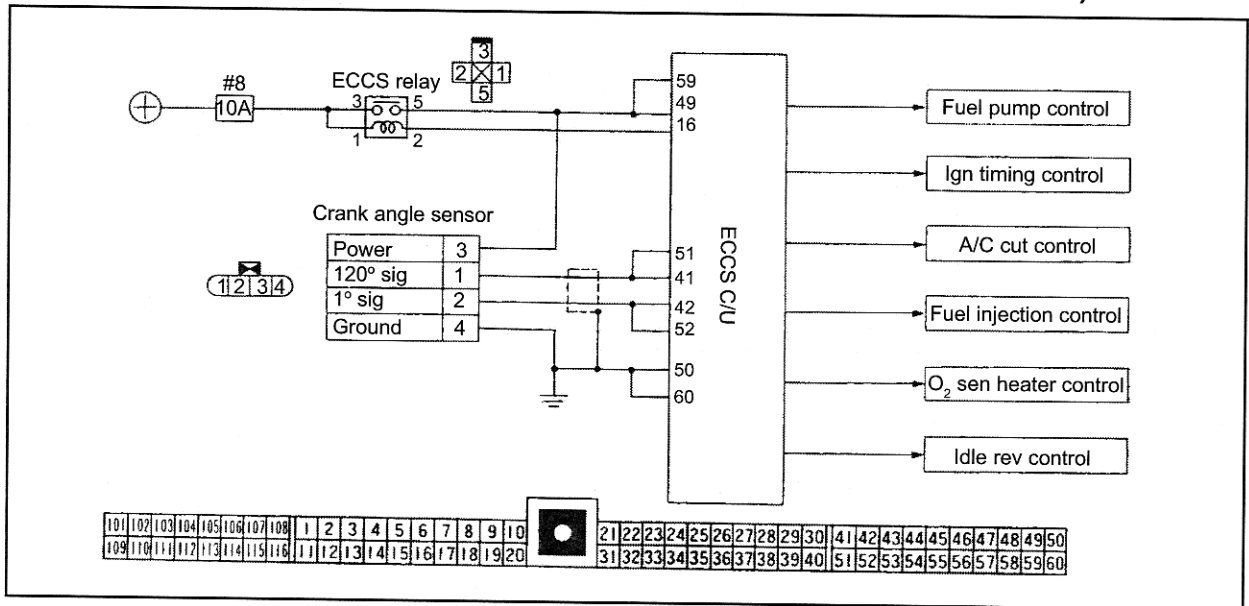

System inspection

- Carry out the "real-time diagnosis" in data monitor mode.
- Carry out self-diagnosis mode 2.

OK Finish

A

☆ MONITORING ☆ NO FAULT

CAS.RPM (POS)	975rpm
AIR FLOW MTR	0.95V
AIR FLOW MTR (R)	0.94V
WATER TEMP SEN	80°C
O2 SENSOR	0.58V
O2 SENSOR (R)	0.51V

START MONITORING

NG

A

ECCS C/U input signal inspection

- Start the engine.
- Carry out "CAS.RPM" in data monitor mode to read rpm.

Engine rev: 950+/-50rpm

- Use tester to measure the power voltage between the following terminals:

41 & 51 terminal (120° signal) voltage	
IGN sw ON:	0V or 5V
Idling:	1.3V
41 & 51 (1° signal) voltage	
IGN sw ON:	0V or 5V
Idling:	2.6V

Values above are pulse wave average voltage when measured using the circuit tester and is only for a reference. Check the wave shape using the oscilloscope.

OK

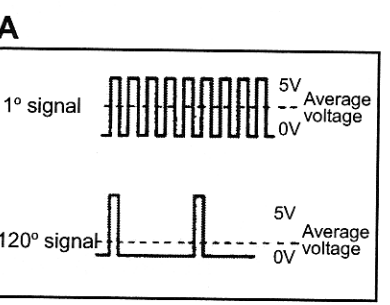
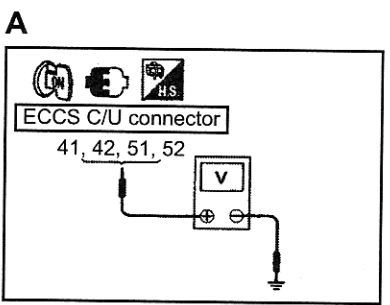

TO B

Inspect ECCS C/U terminal for any damage and ECCS C/U connector connections.

B

Crank angle sensor power supply inspection

- Place ignition sw in the OFF position.
- Remove the crank angle sensor harness connector.
- Place ignition sw in the ON position.
- Check the power voltage between crank angle sensor connector terminal 3 and body earth.

NG

OK

Inspect the following:

Check for continuity between crank angle sensor terminal 3 and ECCS relay terminal 5.

B

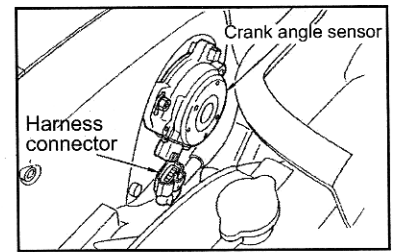

B

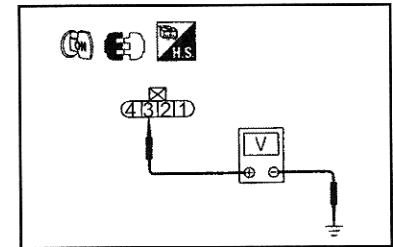

C

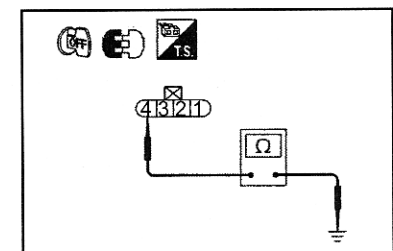

C

Crank angle sensor ground circuit inspection

- Place the ignition sw in OFF position.
- Check for harness continuity between crank angle sensor harness connector terminal 4 and body earth.

NG

OK

Faulty harness or connector.

D

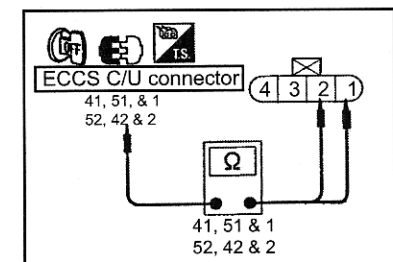

D

ECCS C/U input signal circuit inspection

- Remove ECCS C/U connector.
- Check for harness continuity between ECCS C/U terminal 41 & 51 and crank angle sensor terminal 1 (120° signal), ECCS C/U terminal 42 & 52 and crank angle sensor terminal 2 (1° signal).

NG

OK

Faulty harness or connector.

Component parts inspection

- Check crank angle sensor.

NG

OK

Replace crank angle sensor.

Inspect ECCS C/U terminal for any damage and ECCS C/U connector connections.

3. AIR FLOW METER SYSTEM (SELF-DIAGNOSIS DISPLAY 12)

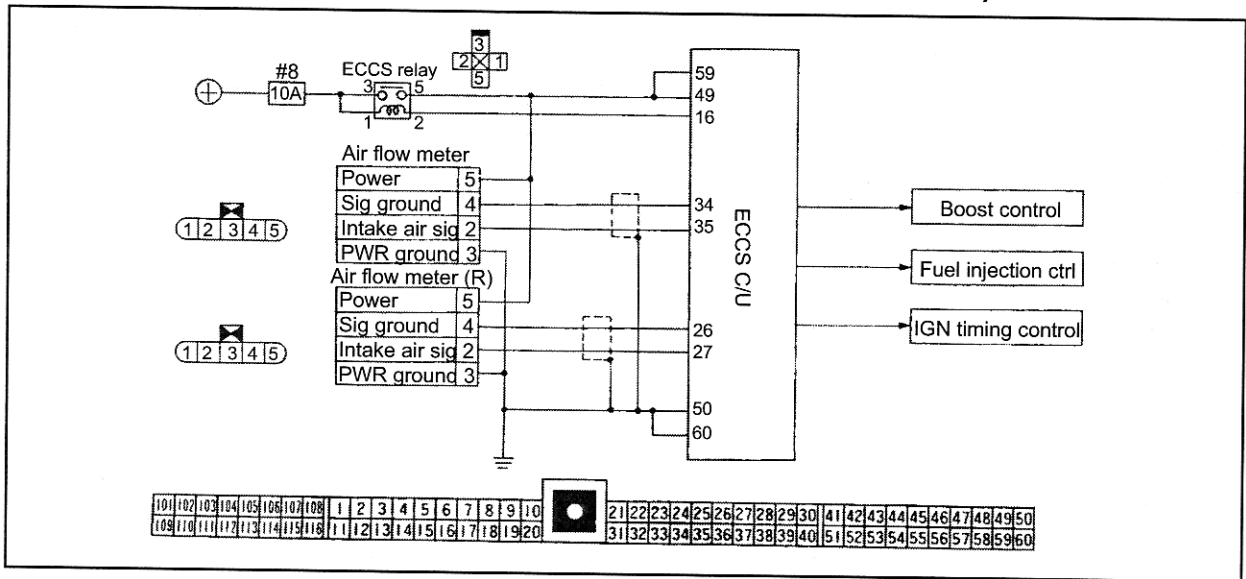

System inspection

- Carry out "Real-time diagnosis" in data monitor mode.
- Carry out self diagnosis mode 2.

OK Finish

A

MONITORING NO FAULT	
CAS.RPM (POS)	975rpm
AIR FLOW MTR	0.95V
AIR FLOW MTR (R)	0.94V
WATER TEMP SEN	80°C
O2 SEN	0.58V
O2 SEN (R)	0.51V
START MONITORING	

NG

A

Input signal inspection

- Check power voltage by carrying out "air flow meter" and "air flow meter (R)" in data monitor.
- Check power voltage between ECCS C/U connector 27 & 35 and body earth.

IGN sw ON: Approx. 0.1V
 Idling: Approx. 0.9V
 2500rpm (with no load): Approx. 1.3~1.7V

OK

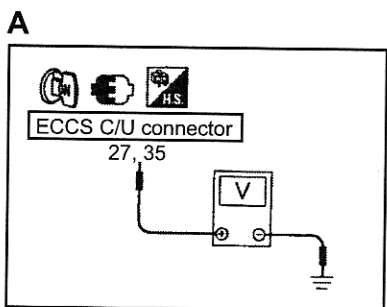

NG

Inspect ECCS C/U terminal for any damage and ECCS C/U connector connections.

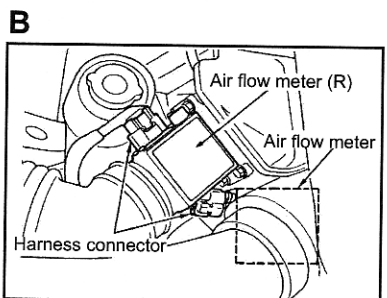

B

Power supply inspection

- Place ignition sw in the OFF position.
- Remove air flow meter harness connector.
- Place ignition sw in the ON position.
- Check power voltage between air flow meter harness connector terminal 5 and body earth.

NG

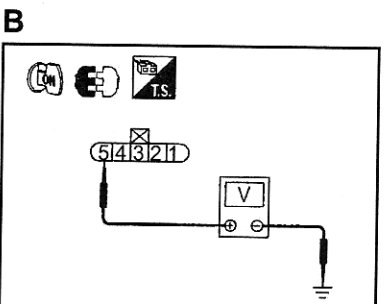

OK

TO C

Inspect the following:
 Harness continuity between air flow meter (R) terminal 5 and ECCS relay terminal 5.
 If NG replace faulty harness or connector.

C

Ground circuit inspection

- Place ignition sw in the OFF position.
- Remove ECCS C/U connector.
- Check for continuity between air flow meter harness connector terminal 4 and ECCS C/U connector terminal 34, air flow meter (R) harness connector terminal 4 and ECCS C/U connector terminal 26.

NG

Faulty harness or connector.

OK

D

Input circuit inspection

- Check for harness continuity between air flow meter harness connector terminal 2 and ECCS C/U connector terminal 35, air flow meter (R) harness connector terminal 2 and ECCS C/U connector terminal 27.

NG

Faulty harness or connector.

OK

Component parts inspection

- Check air flow meter.

NG

Replace air flow meter.

OK

Other system inspection

Check for any air leakage from intake air system.

OK

Inspect ECCS C/U terminal for any damage and ECCS C/U connector connections.

C

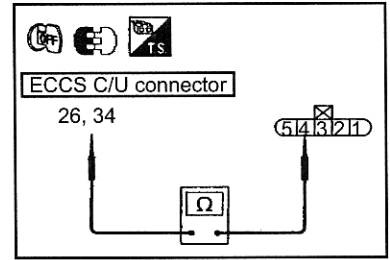

D

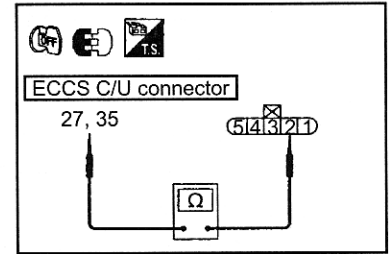

4. WATER TEMPERATURE SENSOR SYSTEM (SELF-DIAGNOSIS DISPLAY 13)

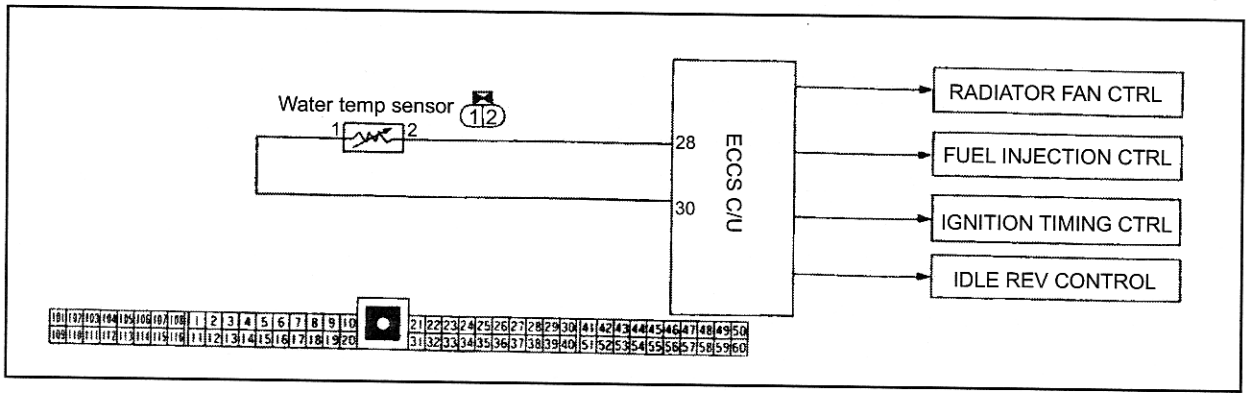

System inspection

- Carry out "Real-time diagnosis" in data monitor mode.
- Carry out self diagnosis mode 2.



OK Finish

NG

Input signal inspection

- Check water temperature by carrying out "water temp sen" data monitor.
- Place ignition sw to ON position.
- Check power voltage between ECCS C/U terminal 28 and body earth.

IGN sw ON

Water temp at 20°C: Approx. 3.5V

Water temp at 80°C: Approx. 1.2V



OK

NG

Inspect ECCS C/U terminal for any damage and ECCS C/U connector connections.

Power inspection

- Place ignition sw in the OFF position.
- Remove engine water sensor harness connector.
- Place ignition sw in the ON position.
- Check power voltage between water temp sensor harness connector terminal 1 and body earth.

OK

NG

TO C

Faulty harness or connector.

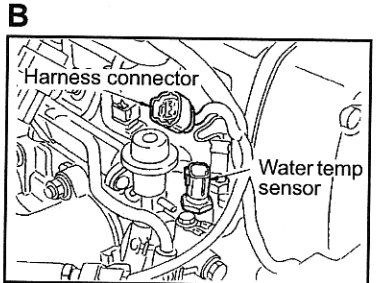
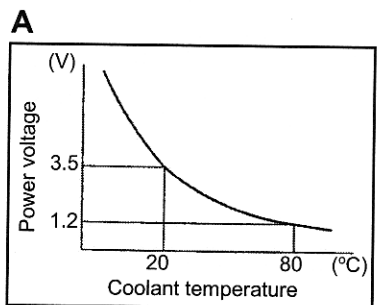
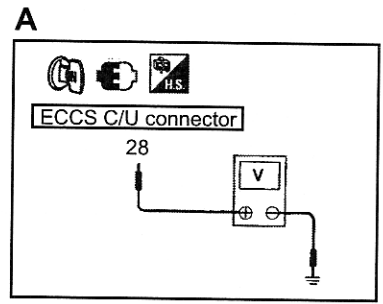
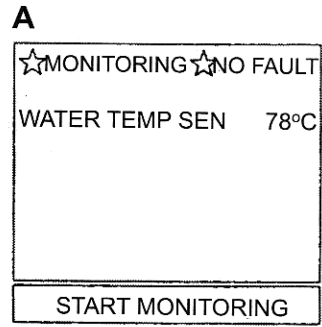

C

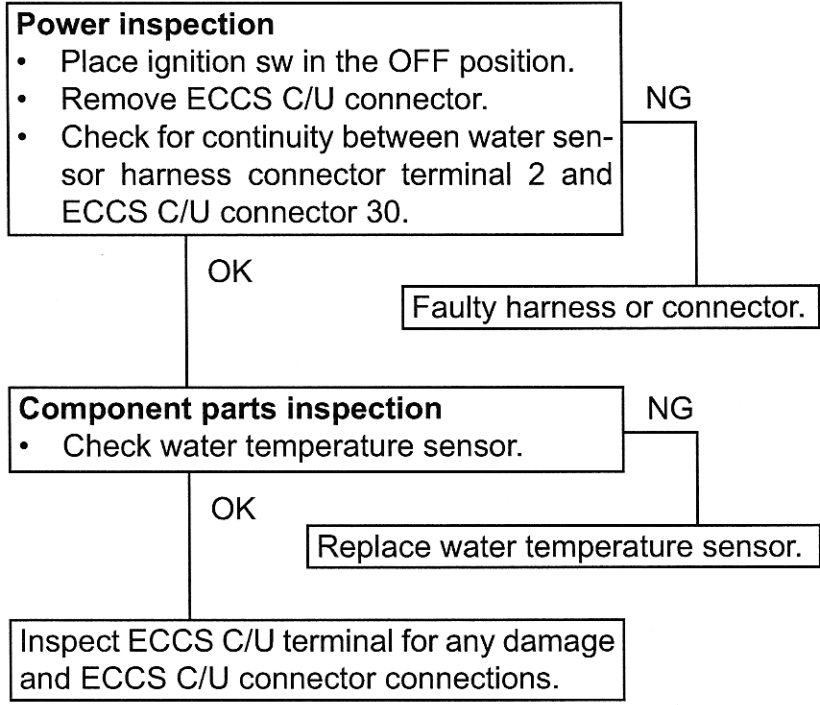

B

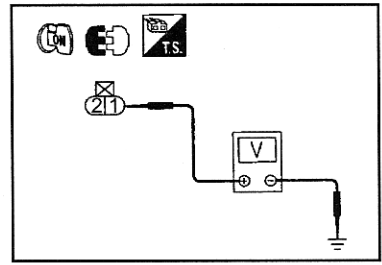

C

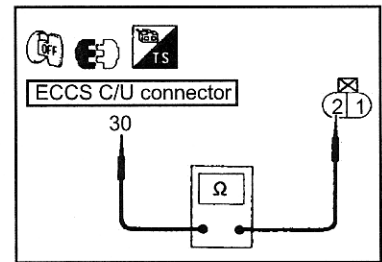

5. IGNITION SYSTEM (SELF-DIAGNOSIS DISPLAY 21)

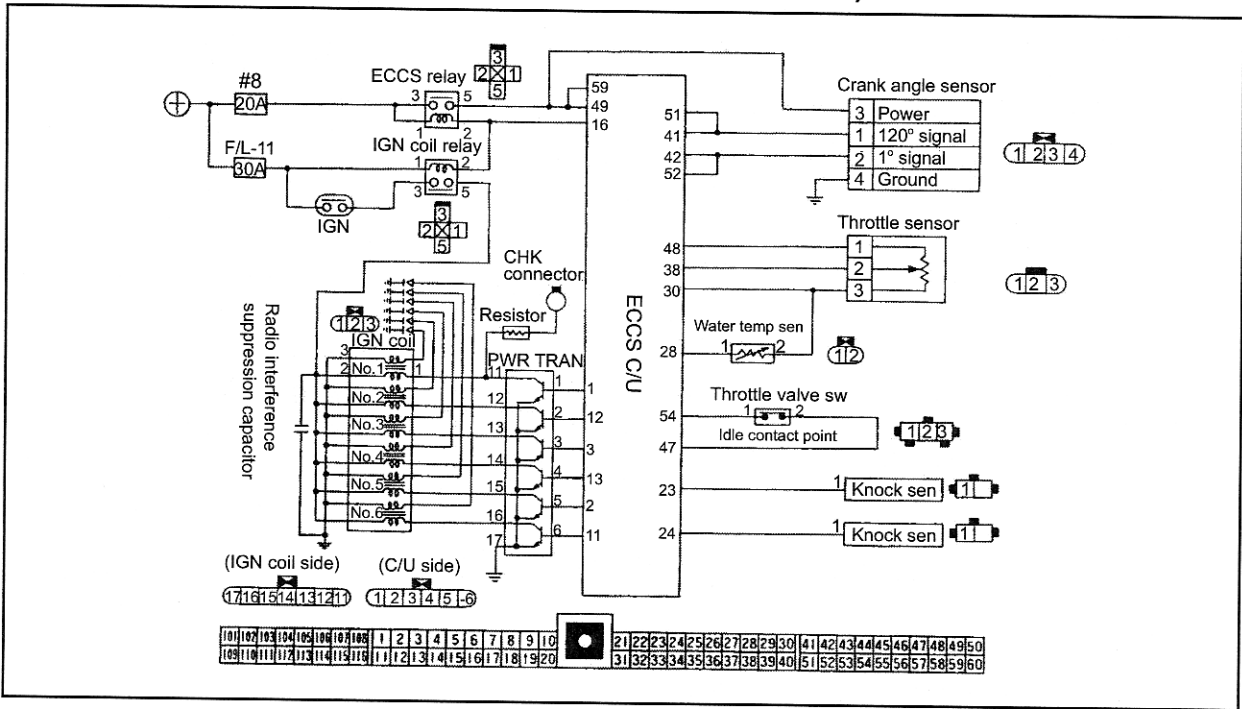

System inspection

- Carry out "Real-time diagnosis" and self-diagnosis.
- Carry out self diagnosis mode 2.



OK



NG

To Ignition system
(not in self-diagnosis mode)

A

◆ POWER BALANCE ◆

STOP INJECTOR DRIVE AT EACH CYLINDER TO CHECK CYLINDER BALANCE.

PASS START

A

Circuit function inspection

- Carry out "power balance" in function test. OR
- "Power balance" in active test.
- Check if the engine rev will decrease momentary.



OK

Finish

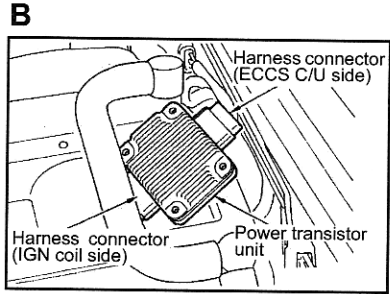

B

Ground circuit inspection

- Place ignition sw in the OFF position.
- Remove power transistor unit harness connector.
- Check continuity between terminal 17 and body earth.

NG

NG

Faulty harness or connector.

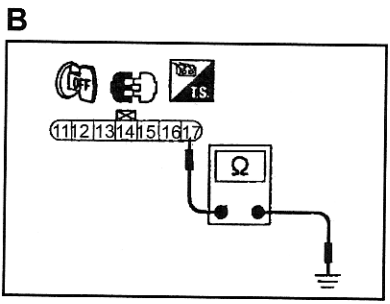

OK
TO C

C

Output circuit inspection

- Place ignition sw in the OFF position.
 - Remove ECCS C/U harness connector.
 - Remove power transistor (6) connectors.
 - Check for continuity between following terminals:
- | | |
|----------------|-----------------|
| ECCS C/U 1 ~ 1 | ECCS C/U 11 ~ 6 |
| ECCS C/U 2 ~ 5 | ECCS C/U 12 ~ 2 |
| ECCS C/U 3 ~ 3 | ECCS C/U 13 ~ 4 |

NG

OK

Faulty harness or connector.

C

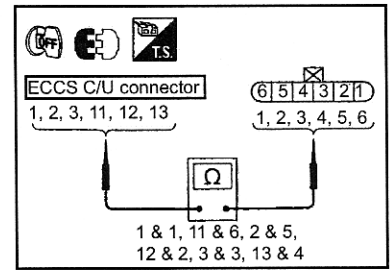

D

Output signal inspection

- Connect power transistor unit and ECCS C/U harness connector.
 - Check power voltage between ECCS C/U terminal 1, 2, 3, 11, 12 & 13 and body earth.
- | | |
|----------------|---------------|
| When cranking: | Approx. 0.05V |
| When idling: | Approx. 0.05V |
| At 2500rpm: | Approx. 0.1V |

NG

OK

Inspect following signal systems:
Crank angle sensor
Water temperature sensor
Throttle sensor
Knock sensor
Ignition sw (start) signal

Component parts inspection

- Check power transistor unit.

NG

OK

Replace power transistor.

Inspect ECCS C/U terminal for any damage and ECCS C/U connector connections.

D

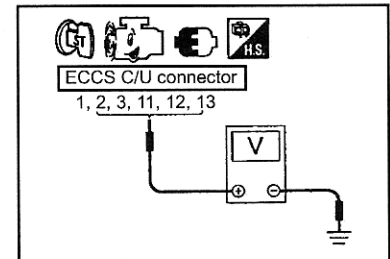

6. DETONATION SENSOR SYSTEM (SELF-DIAGNOSIS DISPLAY 34)

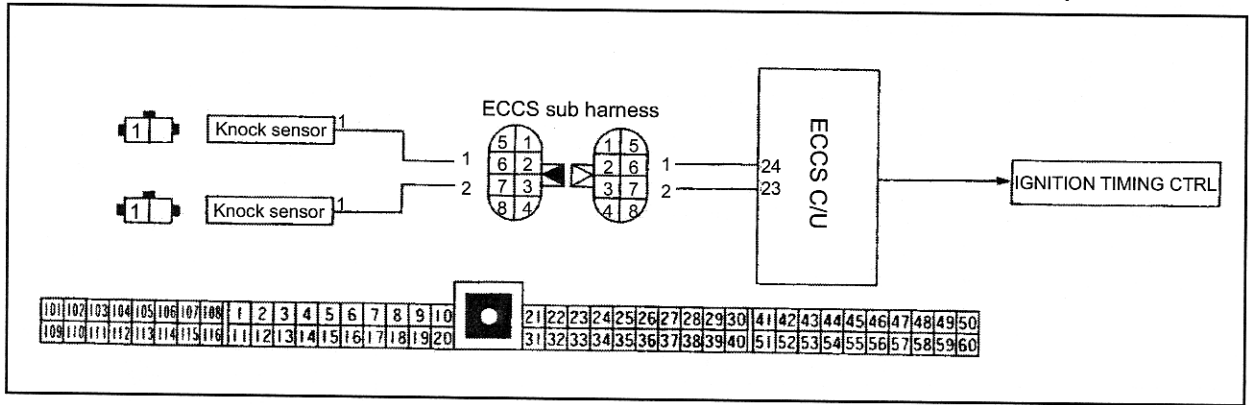

System inspection

- Carry out "Real-time diagnosis" and self-diagnosis.
- Carry out self diagnosis mode 2.



OK Finish



NG

A

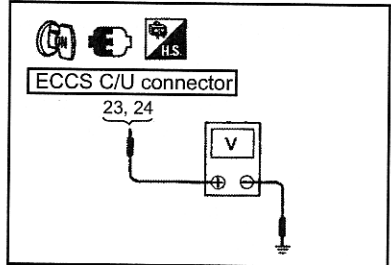

A

Input signal inspection

- Check power voltage between ECCS C/U terminal 23 & 24 and body earth.

When using oscilloscope

Ignition sw in the ON: Approx. 2.0V
 While cranking: Approx. 2.0V
 While idling: Approx. 2.0V

When using circuit tester

Ignition sw in ON: Approx. 0.4~2.0V
 While cranking: Approx. 0.4~2.0V
 While idling: Approx. 0.4~2.0V

The value will differ depending on the circuit tester measurement range. (0.4V is at low range and 2.0V is at high range).

OK

NG

To B

Inspect ECCS C/U terminal for any damage and ECCS C/U connector connections.

B

Input signal circuit inspection

- Place ignition sw in the OFF position.
- Remove ECCS C/U and ECCS sub harness connector.
- Check for continuity between ECCS C/U connector terminal 23 & 24 and ECCS sub harness connector terminal 1 & 2.

NG

OK

Faulty harness or connector.

Replace knock sensor.

Inspect ECCS C/U terminal for any damage and ECCS C/U connector connections.

B

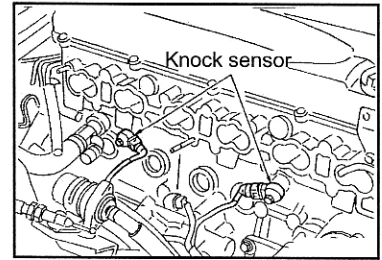

B

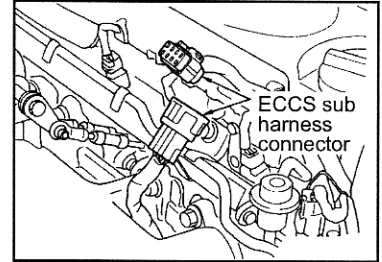

B

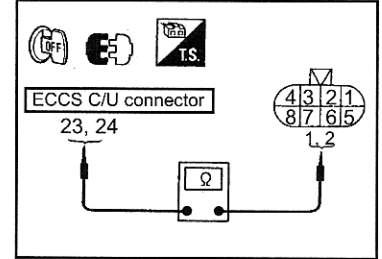

7. INTAKE AIR TEMPERATURE SENSOR SYSTEM
(SELF-DIAGNOSIS DISPLAY 41)

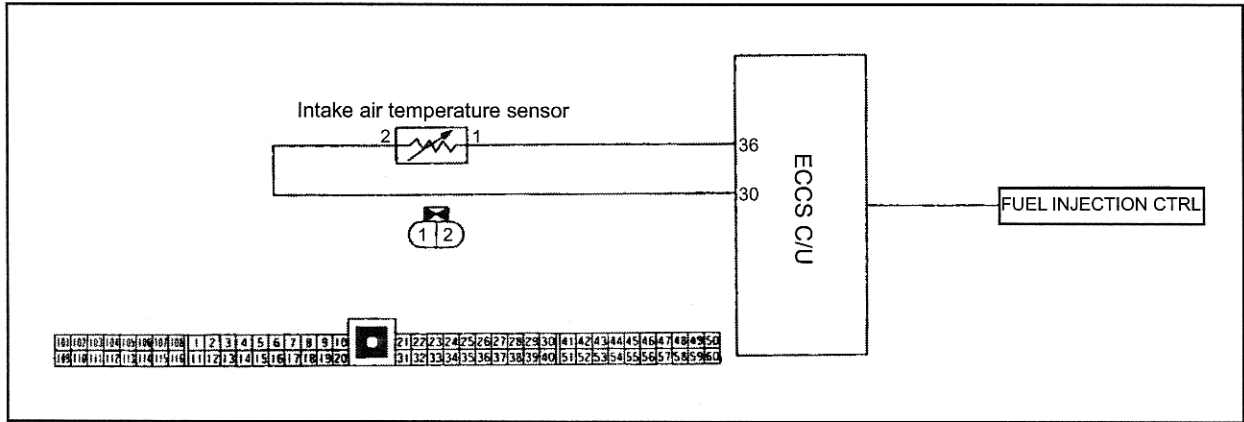

System inspection

- Carry out "Real-time diagnosis" and self-diagnosis.
- Carry out self diagnosis mode 2.

OK Finish

A

☆MONITORING☆ NO FAULT

CAS.RPM (POS) 950rpm
WATER TEMP SEN 38°C

START MONITORING

A NG

Input signal inspection

- Check intake air temperature using "intake air temperature sensor" in data monitor mode.
- Place ignition sw in the ON position.
- Check power voltage between ECCS C/U terminal 36 and body earth.

IGN sw in the ON position:
Intake air temp at 20°C: 3.5V
Intake air temp at 80°C: 1.2V

OK

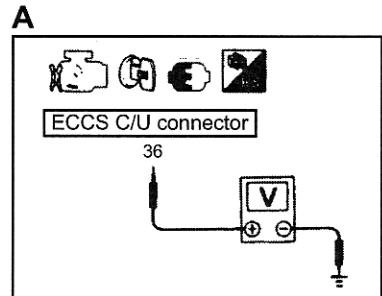

NG

Inspect ECCS C/U terminal for any damage and ECCS C/U connector connections.

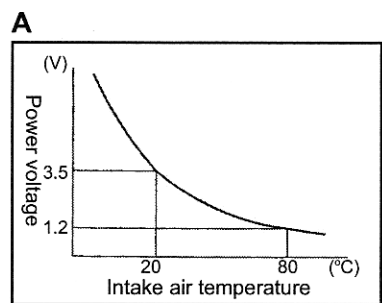

B NG

Power supply inspection

- Place ignition sw in the OFF position.
- Remove intake air temperature sensor harness connector.
- Place ignition sw in the ON position.
- Check the power voltage between intake air temperature sensor harness connector terminal 1 and body earth.

1 ~ body earth: 5V

NG

Faulty harness or connector.

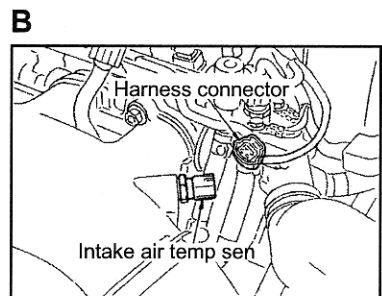

OK
TO C

C

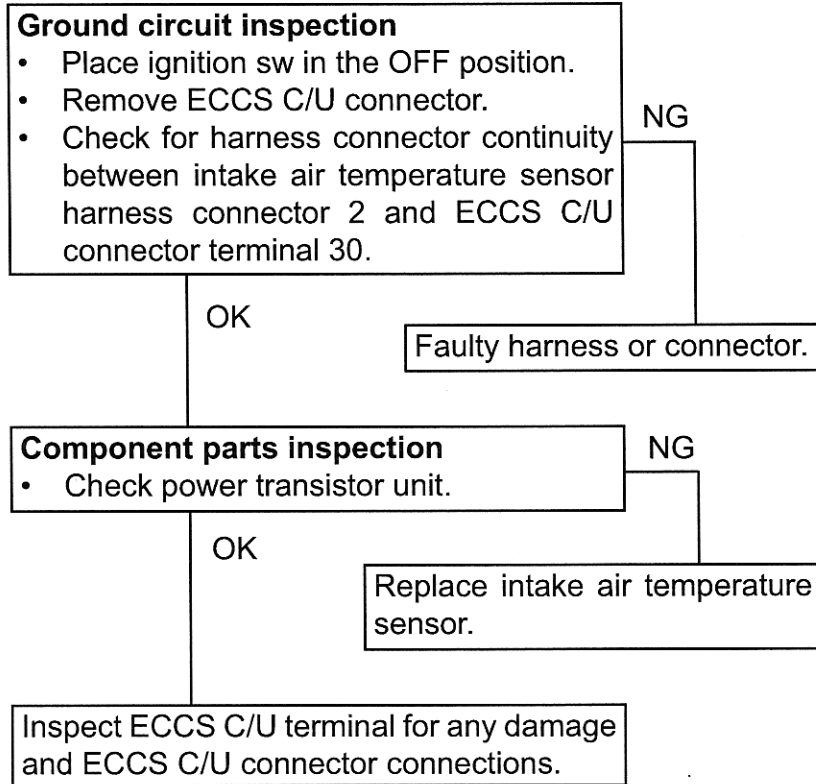

B

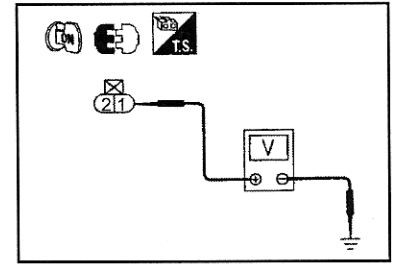

C

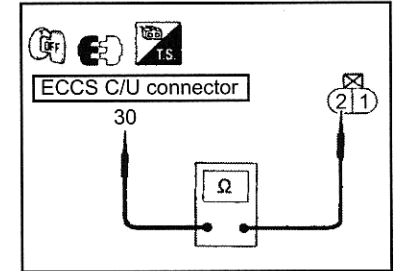

8. THROTTLE SENSOR SYSTEM (SELF-DIAGNOSIS DISPLAY 43)

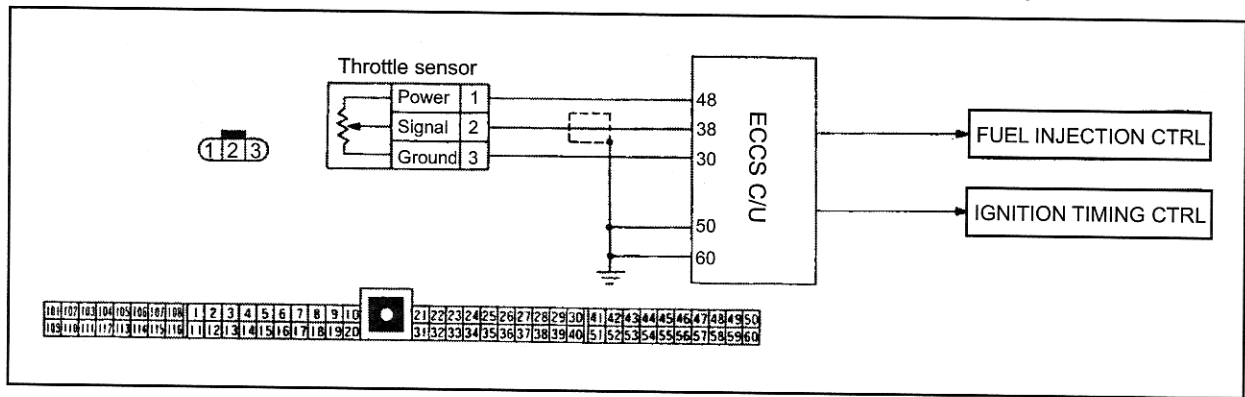

System inspection

- Carry out "Real-time diagnosis" and self-diagnosis.
- Carry out self diagnosis mode 2.



OK Finish

A NG

Input signal inspection

- Place ignition sw in the ON position.
- Carry out "Throttle sensor" in function test mode. OR
- "Throttle sensor" in operation support mode.



OK

- Check the power voltage between ECCS C/U connector 38 and body earth.

When accel pedal depressed: 0.4V
When accel pedal not pressed: 3.8V



NG

Inspect ECCS C/U terminal for any damage and ECCS C/U connector connections.

B

Power supply inspection

- Place ignition sw to OFF position.
- Remove throttle sensor harness connector.
- Place ignition sw to ON position.
- Check the power voltage between throttle sensor harness connector terminal 1 and body earth.

1 ~ body earth: 5V

NG

Check for continuity between ECCS C/U and throttle sensor. If NG faulty harness or connector.

OK

TO C

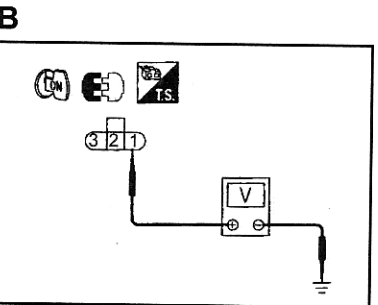
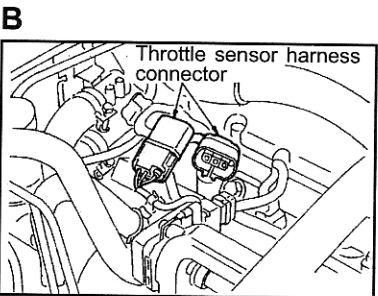
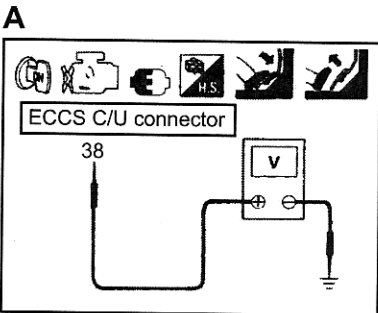
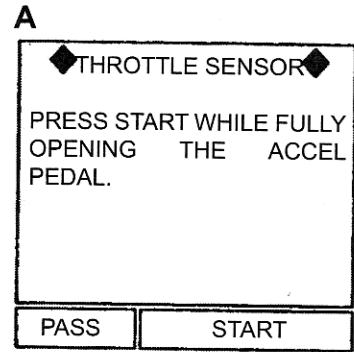

C

Ground circuit inspection

- Place ignition sw in the OFF position.
- Remove ECCS C/U connector.
- Remove throttle sensor harness connector.
- Check for continuity between throttle sensor harness connector terminal 3 and ECCS C/U connector terminal 30.

NG

Faulty harness or connector.

OK

D

Input signal circuit inspection

- Check for continuity between throttle sensor harness connector terminal 2 and ECCS C/U connector terminal 38.

NG

Faulty harness or connector.

Component parts inspection

- Check throttle sensor

NG

Replace throttle sensor.

OK

Inspect ECCS C/U terminal for any damage and ECCS C/U connector connections.

C

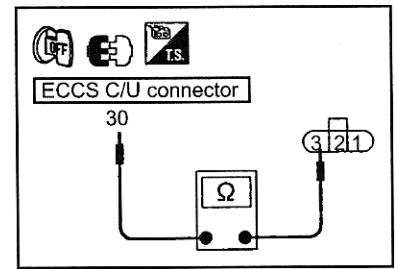

D

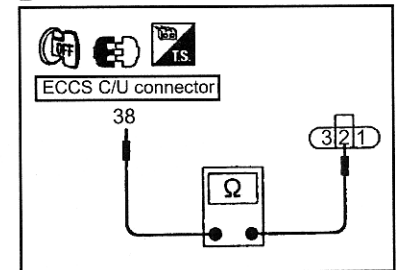

9. O₂ SENSOR SYSTEM (O₂ SENSOR MONITOR IN SELF-DIAGNOSIS DISPLAY)

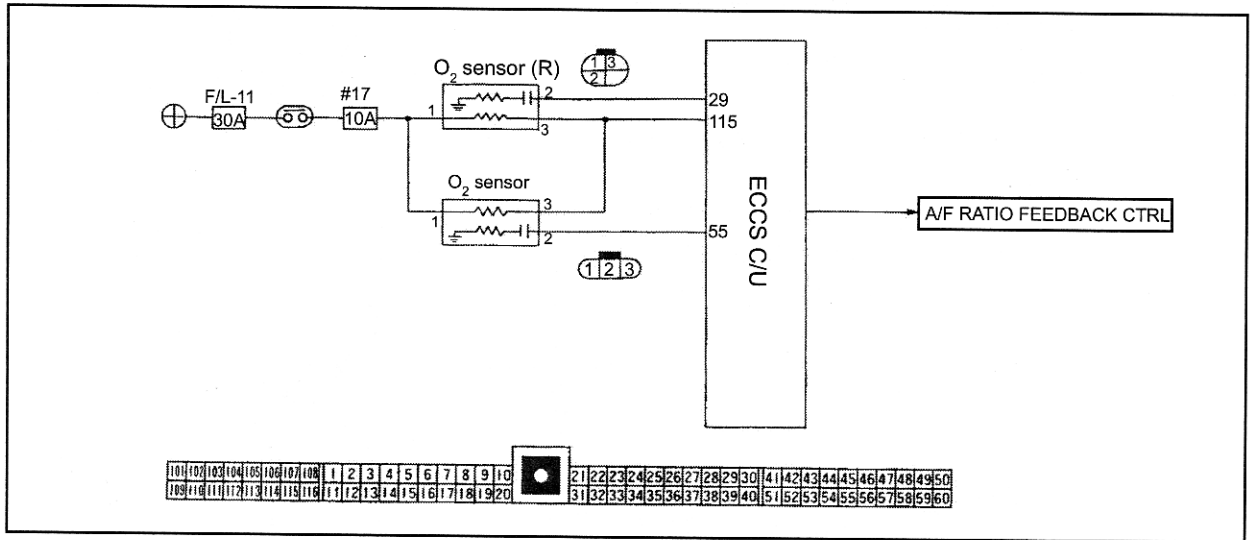

A

System inspection

- Carry out "Base air-fuel ratio test" in function test mode. OR
- Select "O₂ sensor monitor", "O₂ sensor monitor (R)" in data monitor.
- After engine warm-up, set to approx. 2000rpm. Check if LEAN and RICH display is repeated over 5 times in 10 seconds.
RICH - LEAN - RICH - LEAN - RICH

ALSO

1 | 2

- Check "O₂ sensor" and "O₂ sensor (R)" in data monitor mode.
- Operate diagnosis connector on vehicle side to set to "O₂ sensor monitor". Check if engine warning lamp will flash more than 5 times within 10 seconds.

OK Finish

A

◆ BASE A/F RATIO TEST ◆

PRESS START WHILE KEEPING ENGINE REV AT 2000rpm +/- 200rpm.

1800 2000 2200

PASS START

A

MONITORING NO FAULT

CAS.RPM(POS)	975rpm
AIR FLOW MTR	0.95V
AIR FLOW MTR (R)	0.94V
WATER TEMP SEN	80°C
O2 SEN	0.58V
O2 SEN (R)	0.51V
VEH SPEED SEN	0km/h

START MONITORING

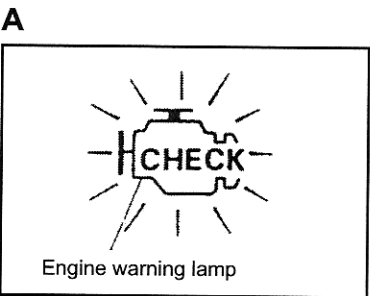

B

Input signal inspection

- Check power voltage between ECCS C/U terminal 29 & 55 and body earth. Engine raced at 2000rpm: Changes approx. 0.1~0.3V - 0.6 ~ 1.0V

OK

NG

TO C

Inspect ECCS C/U terminal for any damage and ECCS C/U connector connections.

C

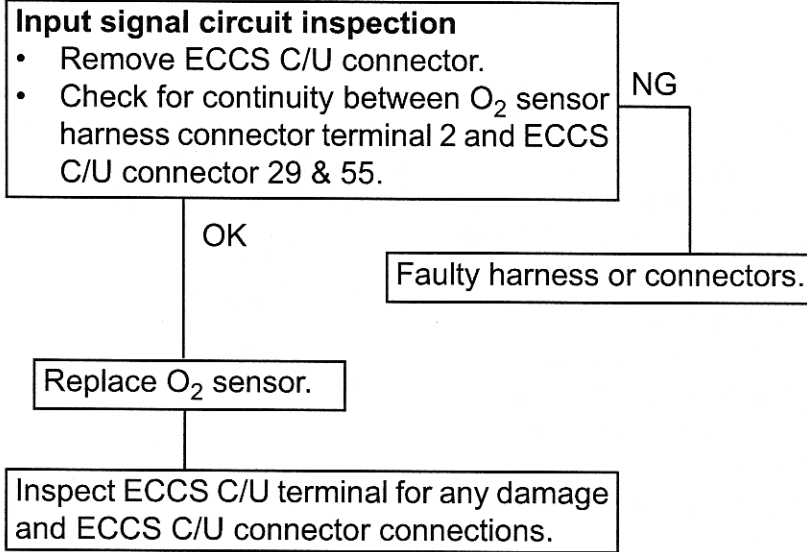

B

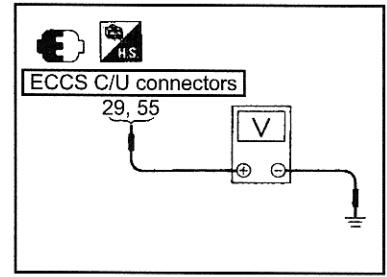

C

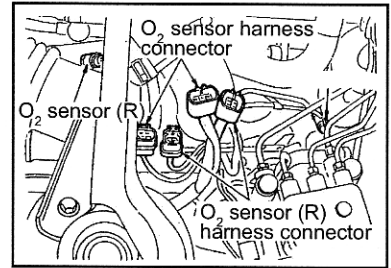

C

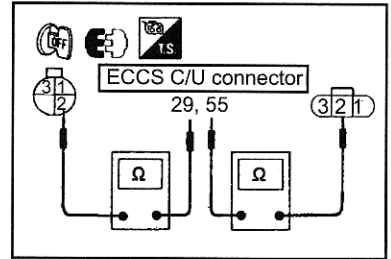

10. COMPONENT PARTS INSPECTION

1. Crank angle sensor

- Remove the crank angle sensor from engine with harness connector still connected.
- Place ignition switch in the ON position.
- Slowly turn the crank angle sensor shaft by hand and inspect the power voltage between terminal 1 & 2 and body earth.

Crank angle sen terminal 2 ~ body earth (1° sig):
Approx. 0V or 5V

Crank angle sen terminal 1 ~ body earth (120° sig):
Approx. 0V or 5V

- If NG replace crank angle sensor.
- After inspection erase self-diagnosis result and make sure code No. 11 is not displayed.

Caution:

Remove the fuse or disconnect the connector to avoid injector from operating.

Abnormality may be detected by self-diagnosis mode if the crank angle sensor shaft is not turned smoothly.

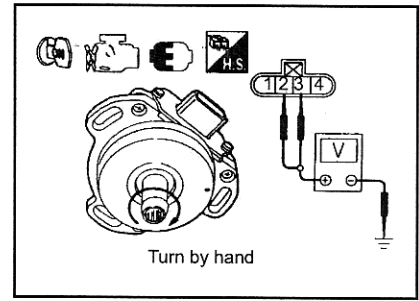

2. Air flow meter

- Place ignition switch in the ON position.
- Directly apply power voltage between air flow meter terminal +5 and terminal -3 and blow air to hot wire area. Inspect the change in output power voltage between terminal +2 and -3.

Output voltage

When air is not blown (V): Approx. 0.8

When air is blown (V): Approx. 2

- If NG inspect hotwire for any damage.

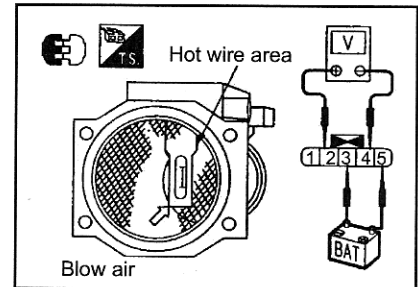

3. Water temperature sensor

- Remove engine water temperature sensor harness connector.
- Check for resistance between water temperature sensor terminal 1 and 2.

Coolant water temperature at 20°C (kΩ): Approx. 2.5

Coolant water temperature at 80°C (kΩ): Approx. 0.3

- If NG replace engine water temperature sensor with a new one.

- After inspection erase self-diagnosis result and make sure code No. 13 is not displayed.

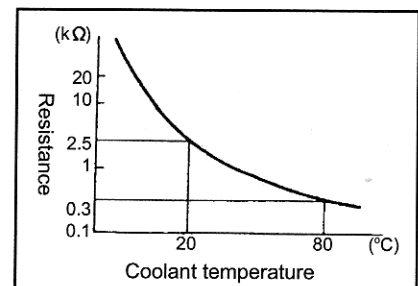
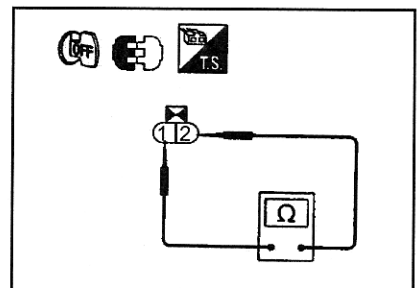

4. Power transistor

- Remove the power transistor harness connector.
- Use analogue type circuit tester to inspect resistance value between each power resistor terminal by changing the positive and negative tester bars.
- After inspection erase self-diagnosis result and make sure code No. 21 is not displayed.
- If NG replace the power transistor.

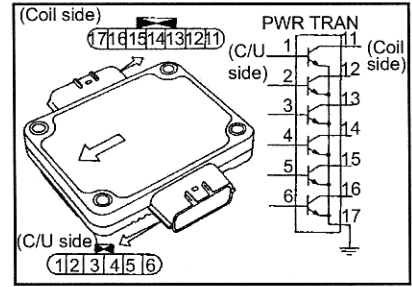

Inspection terminal and value

Connector	Inspection terminal	Tester bar	Inspection value	Tester bar	Inspection value
Coil side	17, 17, 17, 17, 17, 17	(+)	0 or not $\infty\Omega$	(-)	0 or not $\infty\Omega$
C/U side	1, 2, 3, 4, 5, 6	(-)		(+)	
Coil side	17, 17, 17, 17, 17, 17	(+)	$\infty\Omega$	(-)	0 or not $\infty\Omega$
Coil side	11, 12, 13, 14, 15, 16	(-)		(+)	
Coil side	11, 12, 13, 14, 15, 16	(+)	0 or not $\infty\Omega$	(-)	$\infty\Omega$
C/U side	1, 2, 3, 4, 5, 6	(-)		(+)	

5. Intake air temperature sensor

- Remove intake air temperature sensor harness connector.
- Check for resistance between intake air temperature sensor terminal 1 and 2.
Intake air temperature at 20°C (k Ω): Approx. 2.5
Intake air temperature at 80°C (k Ω): Approx. 0.3
- If NG replace intake air temperature sensor.
- After inspection erase self-diagnosis result and make sure code No. 41 is not displayed.

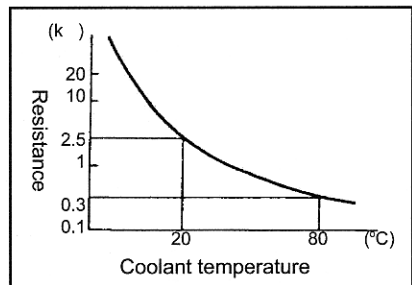
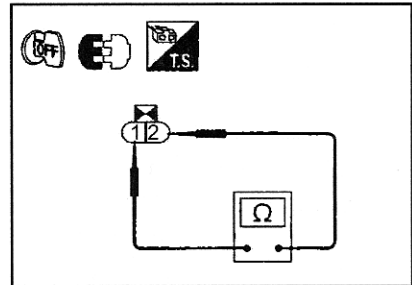

6. Throttle sensor

- Remove the throttle sensor connector.
- Check the resistance between throttle sensor terminal 2 and 3.
Accel pedal not depressed (k Ω): Approx. 1.3
Accel pedal lightly depressed (k Ω): Approx. 5.0
Accel pedal fully depressed (k Ω): Approx. 9.5
- After inspection erase self-diagnosis result and make sure code No. 43 is not displayed.

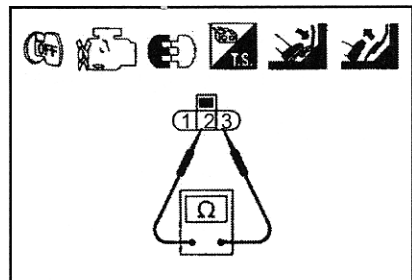

7. ECCS relay

- Check for continuity between terminal 3 and 5 when power voltage is applied to terminal 1 and 2.
Directly apply power voltage to terminal 1 ~ 2:
Continuity present
- No power voltage applied: No continuity

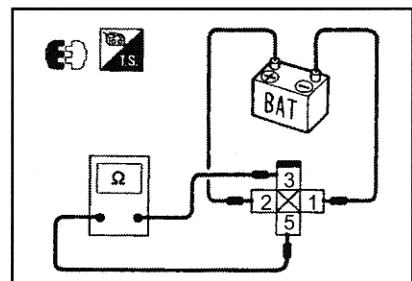

EN8 SYSTEM FAULT DIAGNOSIS

1. FUEL PUMP SYSTEM CONTROL

CONTROL CIRCUIT DIAGRAM RB25DE / RB25DET ENGINE

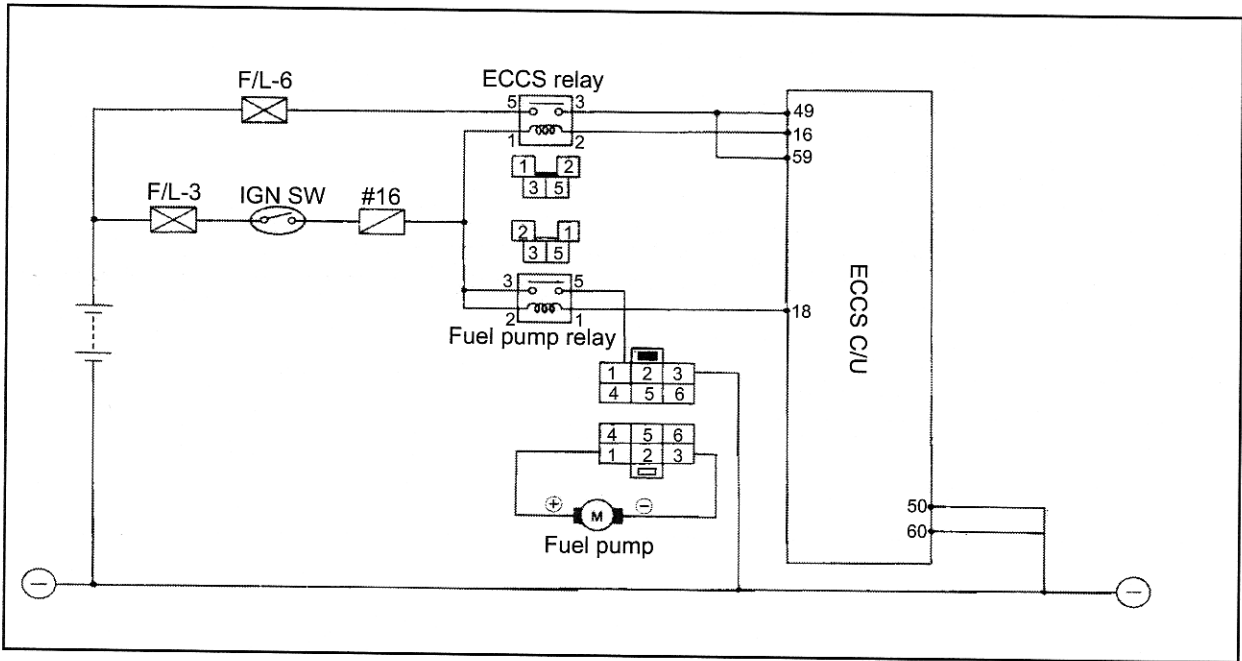

A

System inspection

- Select "FUEL PUMP" in function test mode to inspect the system.
- Carry out operation inspection by "FUEL PUMP RELAY" in active test mode.
- Fuel pump will operate for 5 seconds after the ignition switch is turned to ON position. Check if the fuel pump operation noise are audible.

OK

FINISH

A

◆ FUEL PUMP ◆
IS THERE A PULSATION EVERY 3 SECONDS WHEN THE FUEL TUBE IS HELD? OR CAN YOU HEAR THE FUEL PUMP RELAY OPERATION NOISE?

PASS NO YES

B

NG

Power inspection

- Place ignition switch in the OFF position.
- Disconnect fuel pump relay.
- Measure voltage between earth and terminal 2 & 3 using the tester.

NG

OK

Inspect the following:

- Fuse
 - Harness connection between fuel pump relay and the fuse.
 - Connection between fuel pump relay and the ignition switch.
- If NG repair harness & connector.

TO C

A

◆ ACTIVE TEST ◆

FUEL PUMP RELAY ON

MONITOR

CAS.RPM (POS) 0rpm

START ON/OFF STOP

A

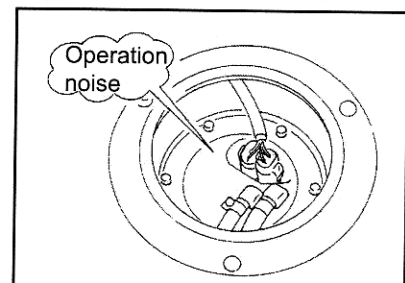

C

Earth circuit inspection

- Place ignition switch in the OFF position.
- Remove fuel pump harness connector.
- Check for continuity between fuel pump harness terminal 3 and the earth.

NG

OK

Faulty harness or connectors.

B

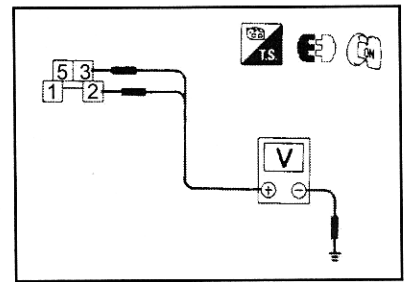

C

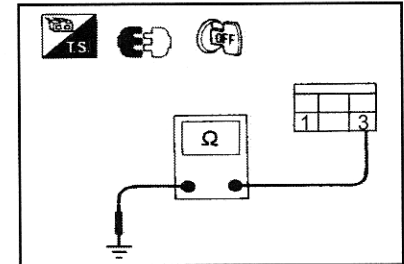

D

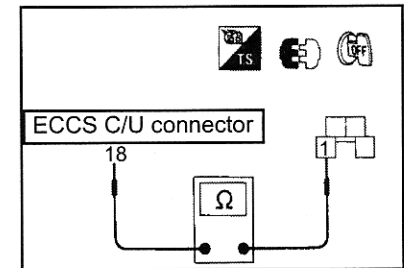

E

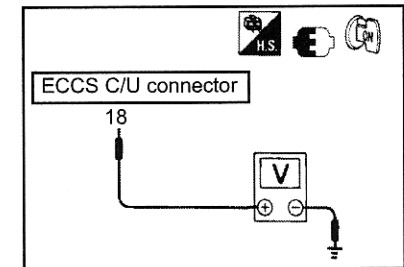

D

Output signal circuit inspection

- Place ignition switch in the OFF position.
- Remove ECCS C/U harness connector.
- Check for continuity between ECCS C/U & harness terminal 18 and fuel pump relay harness terminal 1.

NG

OK

Inspect the following:
Continuity between ECCS C/U and fuel pump relay.
If NG repair harness and the connector.

E

Control signal inspection

- Measure power voltage between earth and ECCS C/U terminal 18.

Within 5 seconds after ignition switch is turned to ON position: 1V
5 seconds after ignition switch is turned to ON position: Power voltage

OK

Component parts inspection

- Inspect fuel pump relay.
- Inspect fuel pump.

NG

OK

Replace fuel pump / relay.

Inspect ECCS C/U terminal for any damage and ECCS C/U connector connections.

2. IGNITION SIGNAL - 1

CONTROL CIRCUIT DIAGRAM RB25DE / RB25DET ENGINE

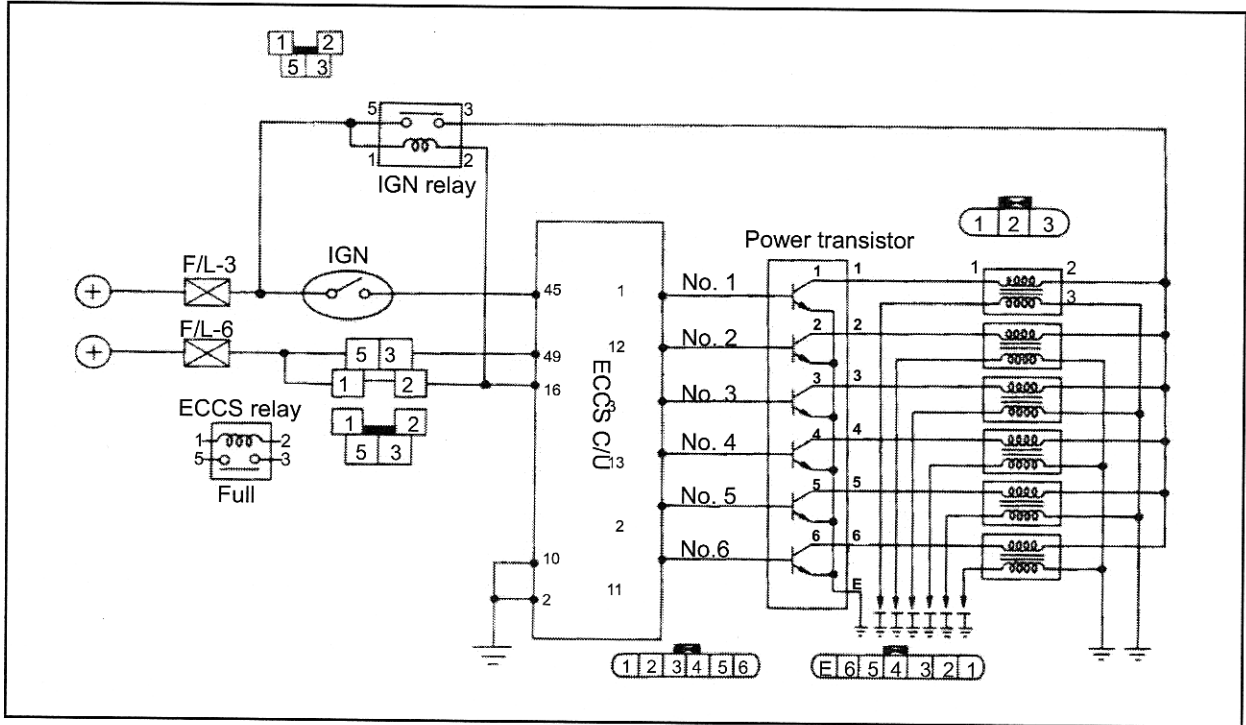

A

Circuit function inspection

- Inspect using "POWER BALANCE" in  function test mode. OR power balance in "ACTIVE TEST".
- Check if engine rev will decrease momentarily.

OK

FINISH

A

◆ POWER BALANCE ◆
INSPECT THE BALANCE OF EACH CYLINDER BY STOPPING INJECTOR OPERATION AT EACH CYLINDER.
TURN OFF A/C & LIGHTS

PASS

START

NG

B

Power supply inspection

- Place ignition switch in the OFF position.
- Remove ignition coil harness connector.
- Place ignition switch in the ON position.
- Use CONSULT or the tester to measure power voltage between each coil terminal 1 and earth.

NG

OK

TO C

Inspect the following:
Ignition relay
Ignition switch
Continuity between each coil Harness terminal 2 and ignition relay terminal 5.

A

◆ ACTIVE TEST ◆
POWER BALANCE MONITOR
CAS.RPM(POS) rpm
AIR FLOW METER V
AAC VALVE %

1	2	3	4	MONITOR START
5	6			

B

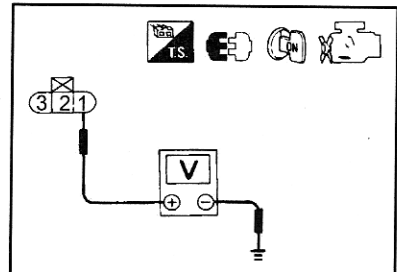

C

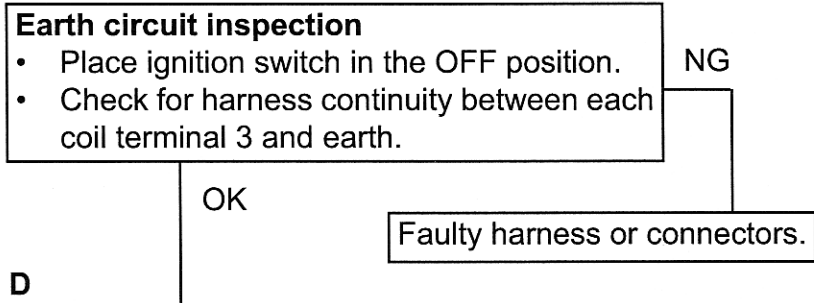

C

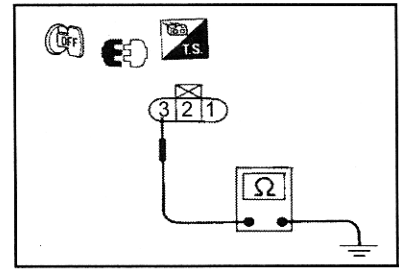

D

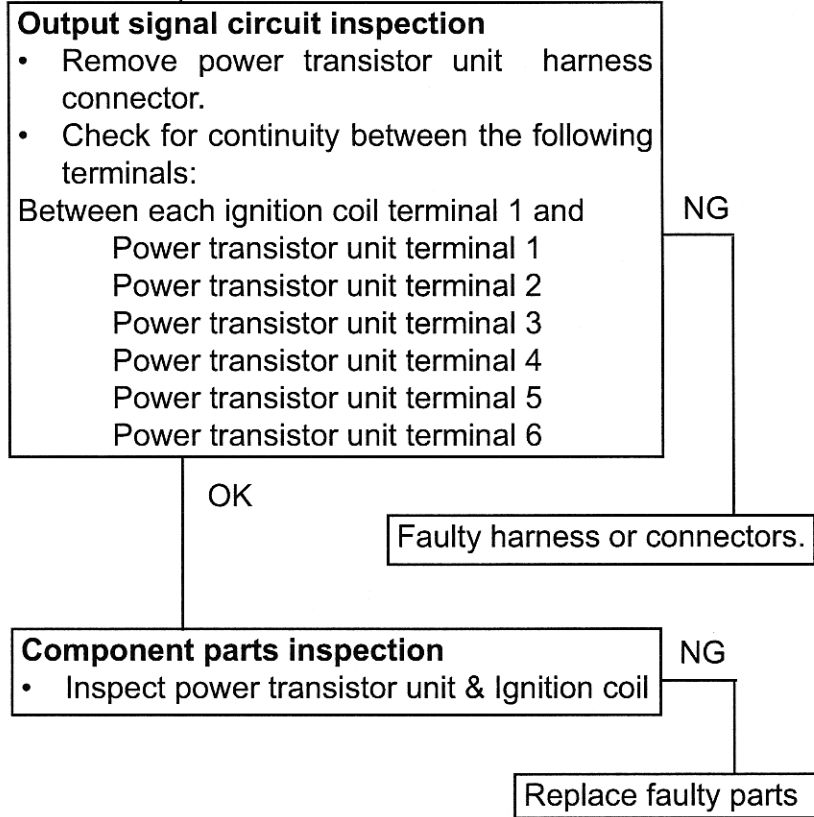

D

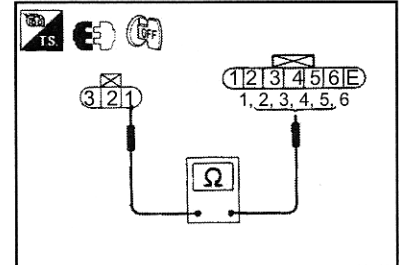

3. IGNITION SIGNAL - 2

Continue from Ignition signal 1

E
Power supply inspection
 • Place ignition switch in the OFF position.
 • Remove ignition coil relay connector.
 • Place ignition switch in the ON position.
 • Use CONSULT or tester to measure the voltage between coil terminal 2, 3 and body earth.

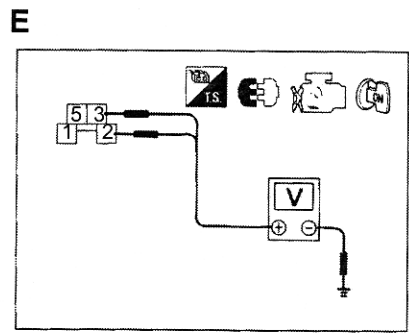

Check the following:
 Continuity between fusible link, ignition coil relay and ignition switch.
 Continuation between ignition coil relay and the battery.

F
Earth circuit inspection
 • Place ignition switch in the OFF position.
 • Inspect harness continuation between each coil terminal 2 and 5.

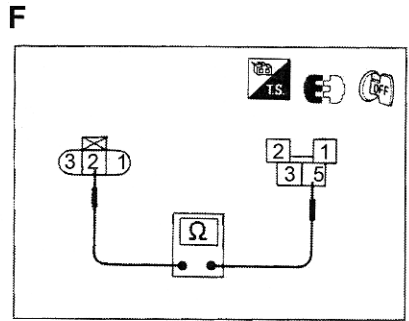

Faulty harness or connectors.

G
Output signal circuit inspection
 • Disconnect ECCS relay.
 • Check for continuation between ECCS C/U terminal 16 and ECCS relay terminal 2.

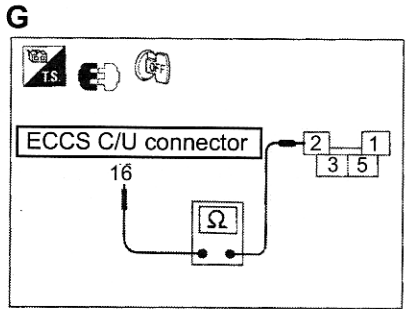

Inspect the following:
 Fusible link.
 Continuation between ECCS C/U and ECCS relay harness.
 Continuation between ECCS C/U and ignition coil relay harness.

Component parts inspection
 • Check ignition coil & ECCS relay

Faulty harness or connectors.

Inspect ECCS C/U terminal for any damage and ECCS C/U connector connections.

4. INJECTOR SYSTEM INSPECTION
CONTROL CIRCUIT DIAGRAM RB25DE / RB25DET ENGINE

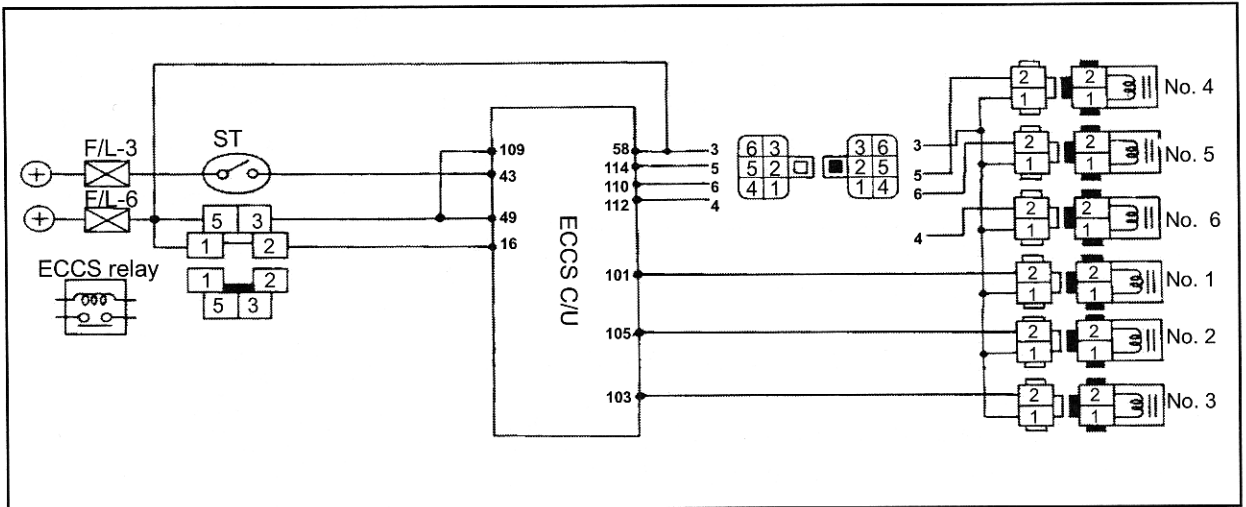

A

Circuit function inspection

- Carry out "POWER BALANCE" in function test mode.
- Operate "POWER BALANCE" in active test mode.
- Make sure the injector operation noise is audible.

OK
FINISH

A

◆ POWER BALANCE ◆

INSPECT BALANCE OF EACH CYLINDER BY STOPPING THE INJECTOR DRIVE FOR EACH CYLINDER.

PASS START

B

NG

Power supply inspection - 1

- Place ignition switch in the OFF position.
- Remove sub harness connector.
- Check the power voltage between terminal 3 and ground using CONSULT or tester.

NG

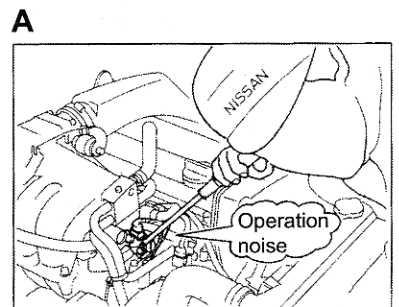

OK

Inspect the following:
 Harness connector.
 Continuity between sub harness connector and the harness.
 If NG repair faulty harness and connector.

C

Power supply inspection - 2

- Place ignition switch in the OFF position.
- Disconnect sub harness connector.
- Check for continuity between terminal 3 and 4, 5, 6.

NG

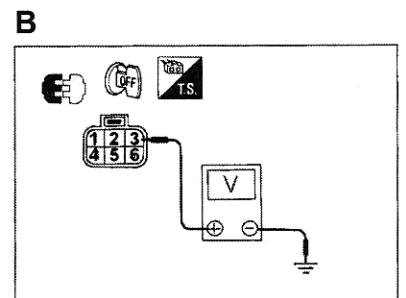

OK

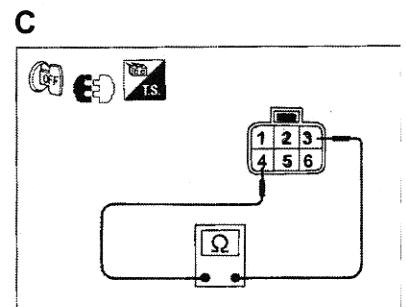

TO D

TO E

D

- Remove injector harness connector.
- Check for continuity between terminal 109 and No. 1, 2, 3, 4, 5 & 6 cylinders.

D

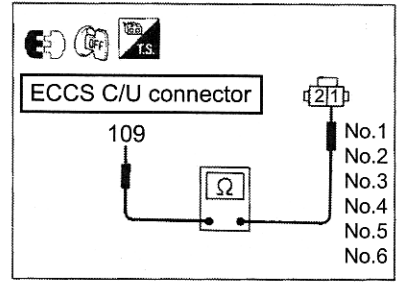

E

- Out put circuit inspection**
- Disconnect ECCS C/U harness connector.
 - Inspect between the following terminals for continuity:
 between terminal 101 and No. 1 cylinder
 between terminal 105 and No. 2 cylinder
 between terminal 103 and No. 3 cylinder
 between terminal 112 and No. 4 cylinder
 between terminal 110 and No. 5 cylinder
 between terminal 114 and No. 6 cylinder

NG

Faulty harness or connectors.

- Component parts inspection**
- Check Injector

NG

Replace injector.

Inspect ECCS C/U terminal for any damage and ECCS C/U connector connections.

E

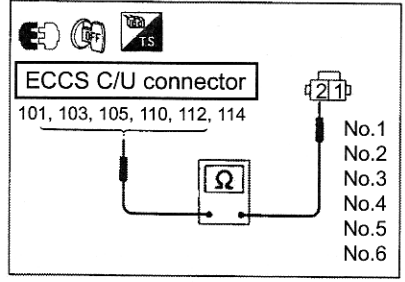

5. VEHICLE SPEED SENSOR SYSTEM
CONTROL CIRCUIT DIAGRAM RB25DE / RB25DET ENGINE

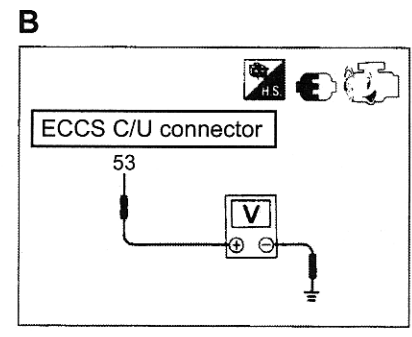
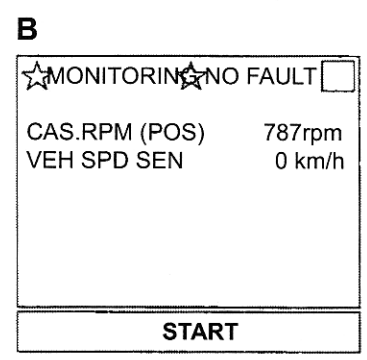
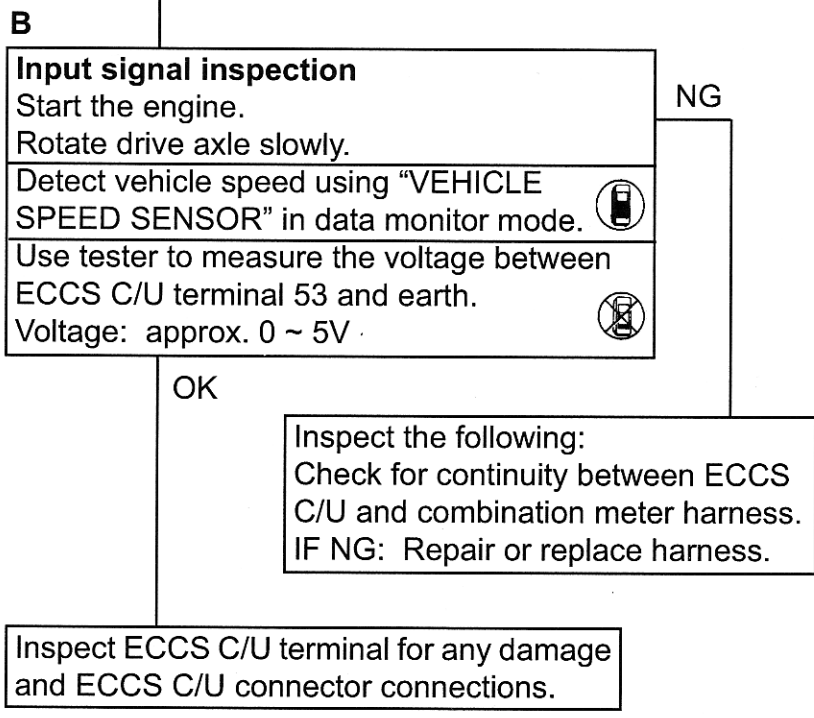
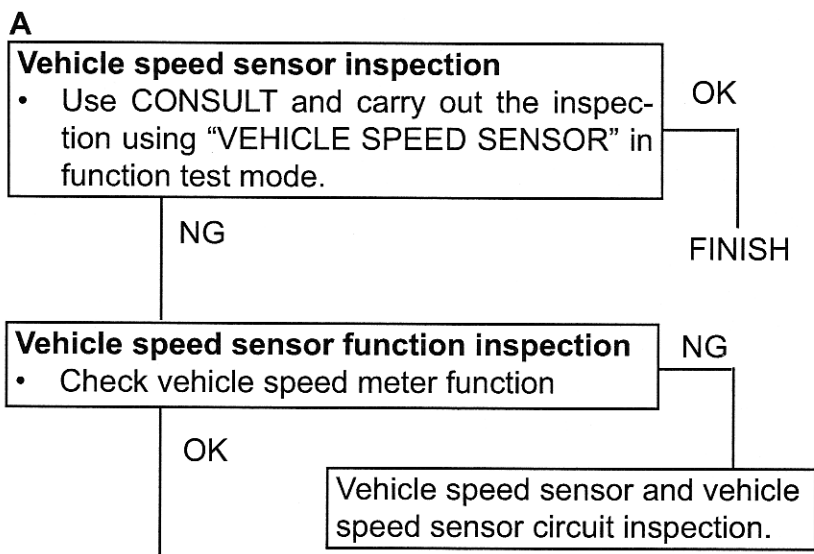
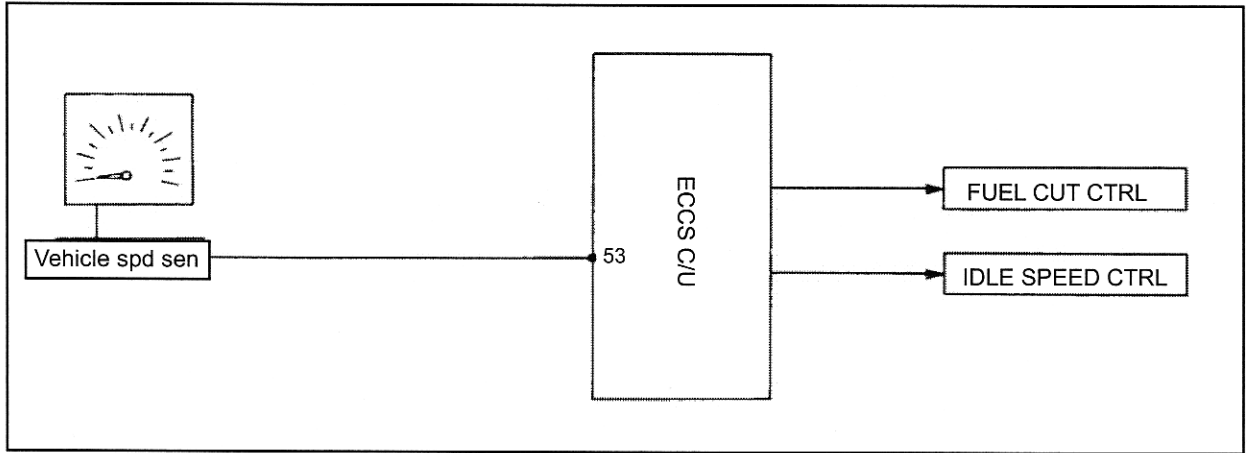

6. AIR CONDITIONER RELAY SYSTEM
CONTROL CIRCUIT DIAGRAM RB25DE / RB25DET ENGINE

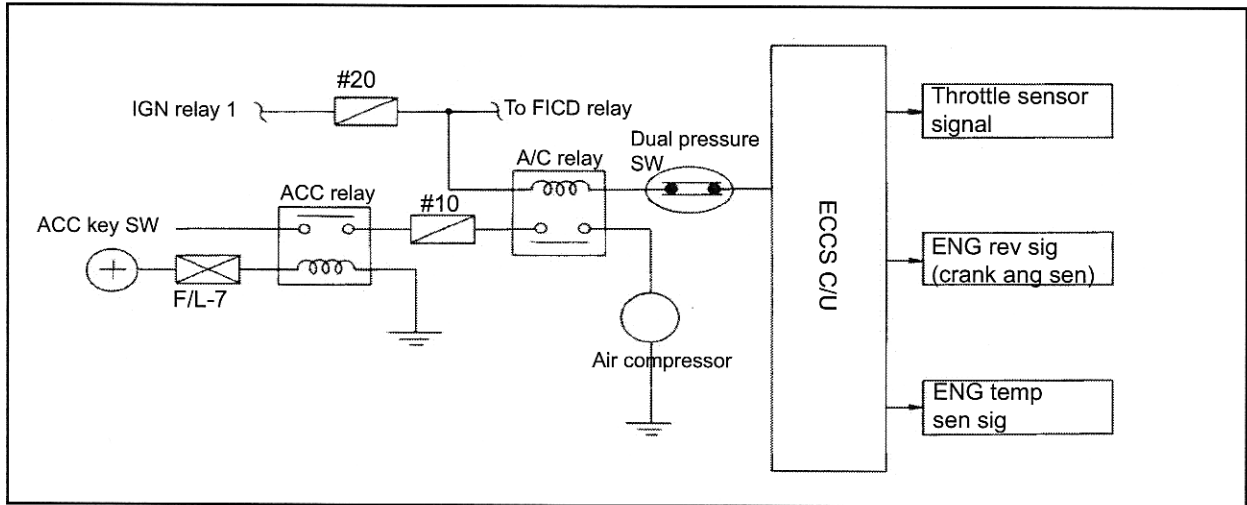

Input signal inspection

- Place ignition switch in the ON position.
- Use tester and measure the battery voltage between ECCS C/U terminal 9 and earth.

blow-fan switch is OFF: PWR voltage
 blow-fan switch is ON: Approx. 1V

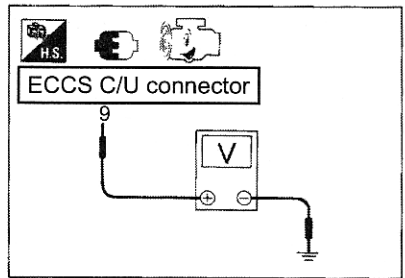

NG

OK

FINISH

Inspect ECCS C/U terminal for any damage and ECCS C/U connector connections.

**7. EXHAUST GAS SENSOR HEATER SYSTEM
CONTROL CIRCUIT DIAGRAM RB25DE / RB25DET ENGINE**

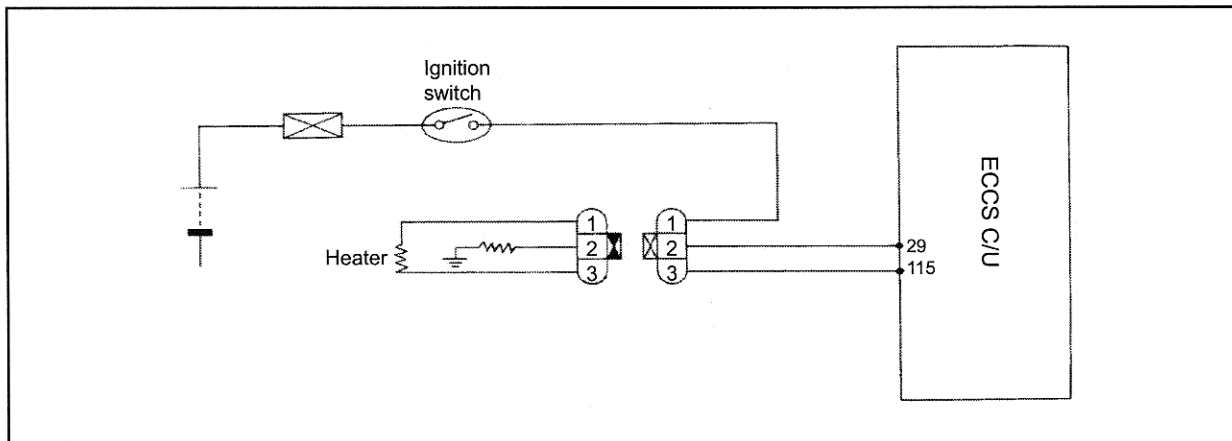

A

Power supply inspection

- Remove exhaust gas sensor harness connector.
- Place ignition switch in the ON position.
- Measure power voltage between terminal 1 and earth.

NG

OK

Inspect the following:
Harness connector.
Continuity between exhaust gas sensor and the fuse.
If NG repair harness and connector.

A

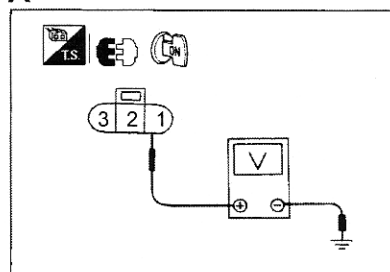

B

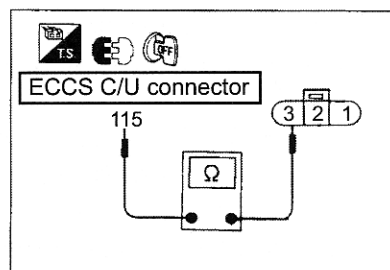

B

Ground circuit inspection

- Place ignition switch in the OFF position.
- Disconnect ECCS C/U harness connector.
- Check for continuity between terminal 3 and ECCS C/U terminal 115.

NG

OK

Faulty harness or connectors.

Component parts inspection

- Check exhaust gas sensor heater.

NG

OK

Replace exhaust gas sensor.

Inspect ECCS C/U terminal for any damage and ECCS C/U connector connections.

8. THROTTLE VALVE SWITCH SYSTEM
CONTROL CIRCUIT DIAGRAM RB25DE / RB25DET ENGINE

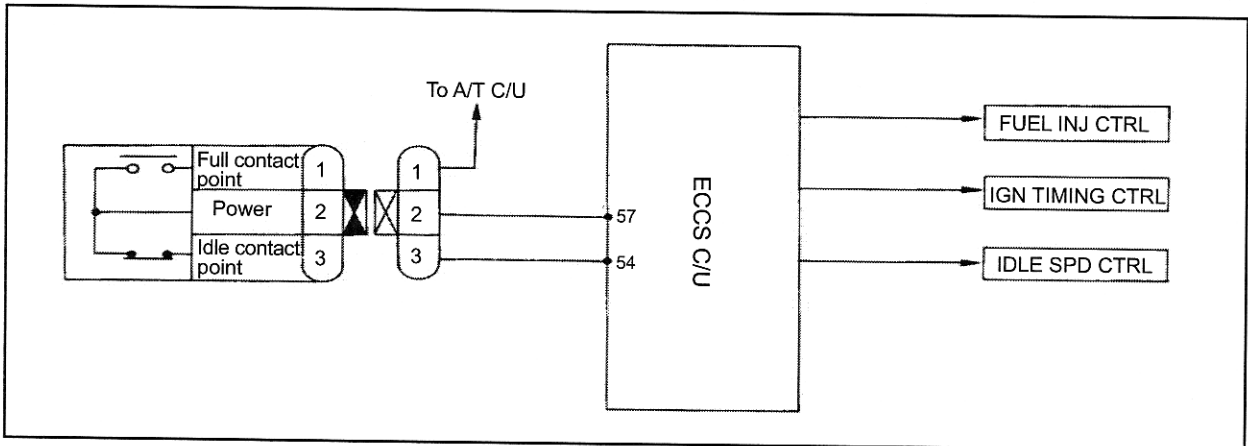

A

Function inspection - 1

- Place ignition switch in the ON position.
- Inspect using "IDLE JUDGEMENT" in function test mode.

Fully open: OFF
 Fully closed: ON

OK
 FINISH

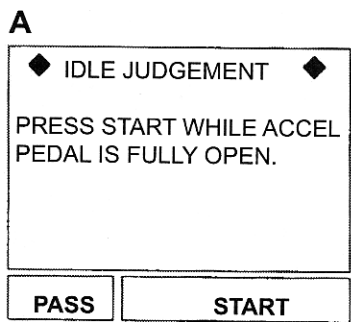

B

Function inspection - 2

- Place ignition switch in the ON position.
- Inspect ignition switch "ON-OFF" diagnosis or measure power voltage between ECCS C/U terminal 54 and earth using the tester when ignition switch is in ON.

Accelerator pedal depressed 0V
 Accelerator pedal not depressed 8 ~ 10V

OK
 FINISH

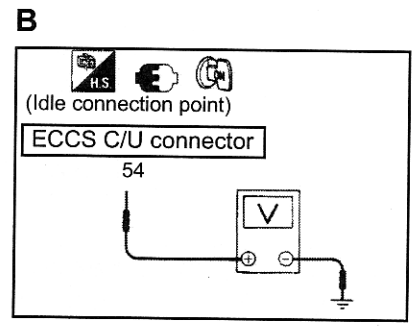

C

Power supply inspection

- Place ignition switch in the OFF position.
- Remove throttle valve switch harness connector.
- Place ignition switch in the ON position.
- Use tester to measure power voltage between terminal 2 and earth.

Power voltage: Approx. 8 ~ 10V

NG

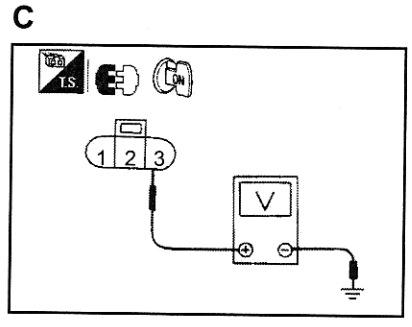

Inspect the following:
 Harness continuity between throttle valve switch and ECCS C/U.
 If NG repair faulty harness and connector.

OK
 TO D

D

Input signal circuit inspection

- Place ignition switch in the OFF position.
- Disconnect ECCS C/U harness connector.
- Disconnect throttle valve switch harness connector.
- Check for continuity between ECCS C/U terminal 54 and throttle valve switch terminal 1.

NG

Faulty harness or connectors.

OK

Component parts inspection

- Check throttle valve switch.

NG

Replace throttle valve switch.

OK

Inspect ECCS C/U terminal for any damage and ECCS C/U connector connections.

D

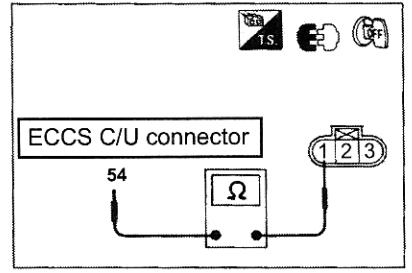

9. START SIGNAL
CONTROL CIRCUIT DIAGRAM RB25DE / RB25DET ENGINE

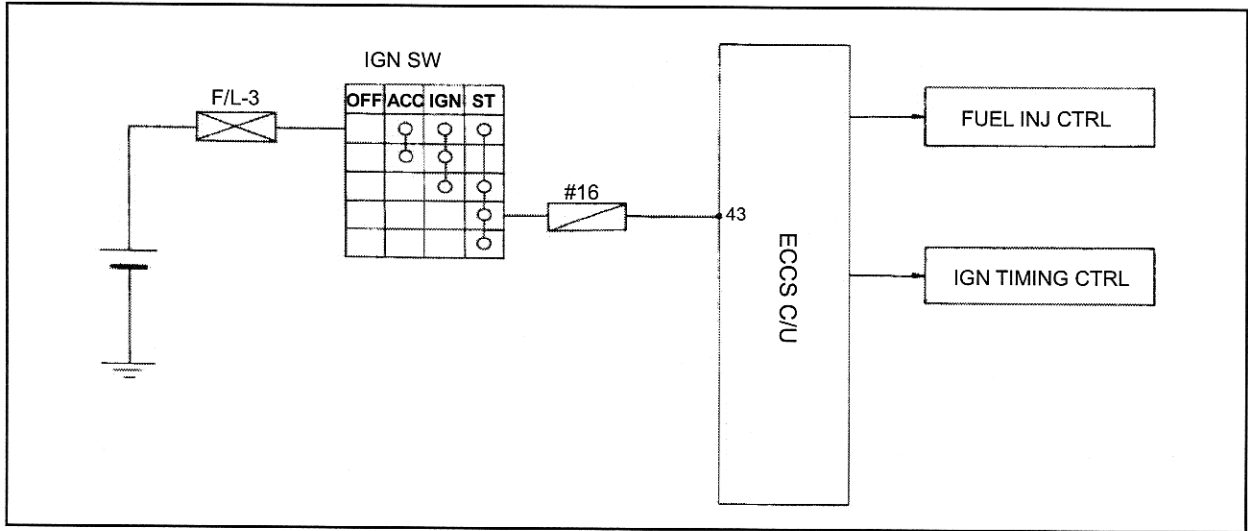

A

Function inspection

- Place ignition switch in the ON position.
- Use CONSULT and inspect "START SIGNAL" in function test mode. OR
- Inspect start signal using "DATA MONITOR" mode.

Ignition switch is in ON position: OFF
 Ignition switch is in START position: ON

OK
 FINISH

A

◆ STARTER SIGNAL ◆
 PLACE SHIFT LEVER IN "P" OR "N" AFTER FULLY OPENING THE ACCEL PEDAL. START THE ENGINE STRAIGHT AFTER SELECTING START.

PASS START

B

Power supply inspection

- Place ignition switch in OFF position.
- Remove throttle valve switch harness connector.
- Place ignition switch in the ON position.
- Use tester to measure the voltage between terminal 2 and earth.

Battery voltage: Approx. 8 ~ 10V

NG

NG

Inspect the following:
 Fuse
 Continuity between ignition switch and ECCS C/U harness.
 If NG repair harness and connector.

Inspect ECCS C/U terminal for any damage and ECCS C/U connector connections.

A

☆ MONITORING ☆ NO FAULT

CAS.RPM (POS) 1326rpm
 STARTER SIGNAL OFF

RECORD

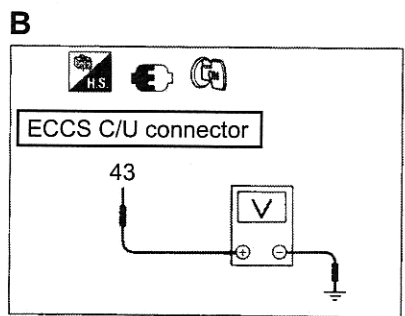

10. AAC VALVE SYSTEM
CONTROL CIRCUIT DIAGRAM RB25DE / RB25DET ENGINE

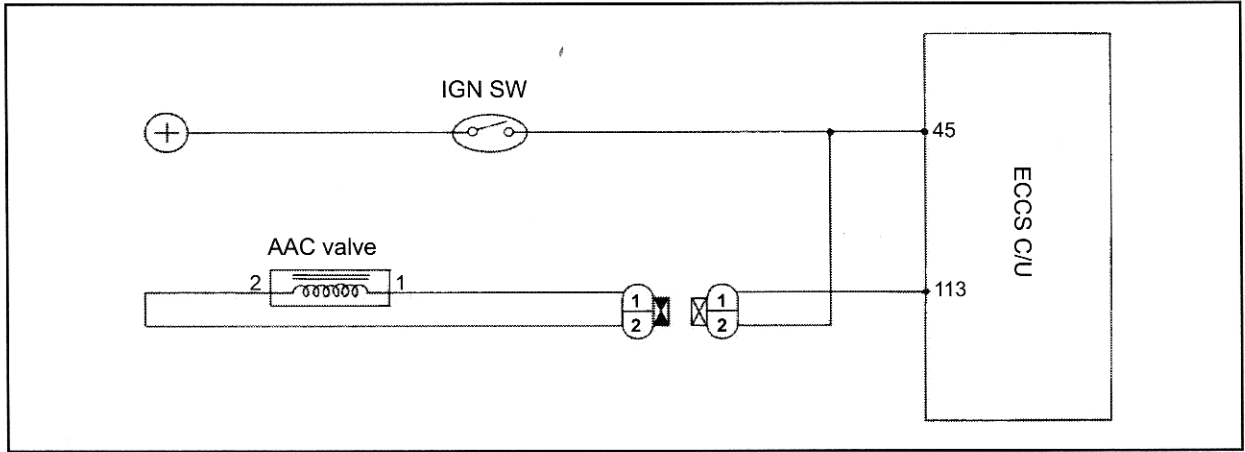

A

Function inspection 

- Warm the engine.
- Check the idle rev 600 ~ 700 rpm.
- If not within standard value adjust idle speed.
- Inspect using "AAC VALVE " in function test mode.

OK

- Disconnect AAC valve harness. 
- Check if idle rev will decrease.

FINISH

A

◆ AAC VALVE ◆

TURN OFF A/C AND LIGHTS SWITCHES BEFORE STARTING.

PASS START

B

NG

Power inspection

- Place ignition switch in the ON position.
- Measure voltage between earth and AAC valve terminal 2.

NG

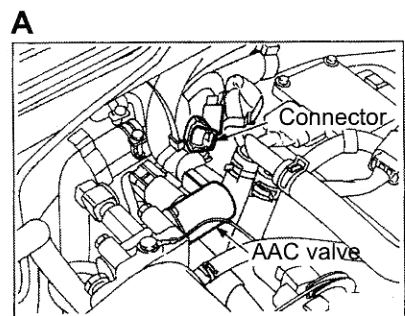

Faulty harness or connectors.

C

Output signal circuit inspection 

- Check if the engine rev will change when "UP" or "DOWN" is pressed in "AAC VALVE" in active test mode.
- Disconnect ECCS C/U harness.
- Check for continuity between ECCS C/U harness terminal 4 and AAC valve connector terminal 1. 

NG

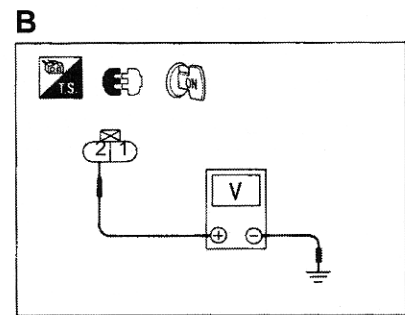

Faulty harness or connectors.

Component parts inspection

- Check AAC valve.

If NG replace AAC valve.

C

◆ ACTIVE TEST ◆

AAC/V OPENING DEG 10% MONITOR

CAS.RPM (POS) 900rpm

AIR FLOW MTR 1.16V

ENGINE TEMP SEN 80°C

Qu UP DWN Qd

11. AIR REGULATOR
CONTROL CIRCUIT DIAGRAM RB25DE / RB25DET ENGINE

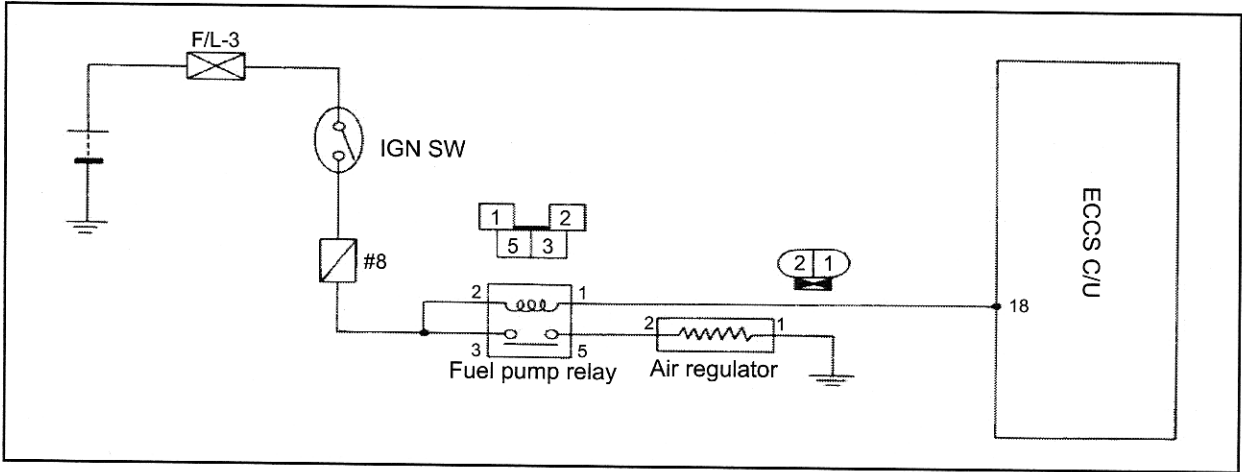

A

Power supply inspection

- Place ignition switch in the OFF position.
- Disconnect fuel pump relay.
- Place ignition switch in the ON position.
- Use tester to measure the voltage between terminal 2, 3 and earth.

NG

OK

Inspect the following:
 Harness continuity between fuel pump relay and fuse.
 Continuity between fuel pump relay and ignition switch.
 If NG repair harness and connector.

A

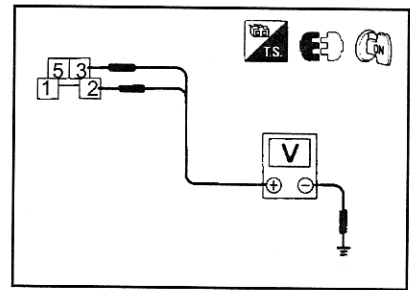

B

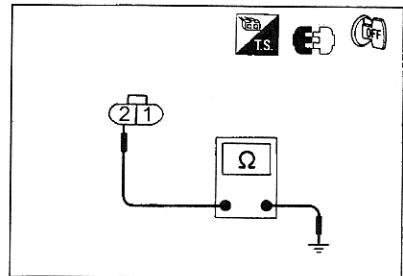

B

Earth circuit inspection

- Place ignition switch in the OFF position.
- Remove air regulator harness connectors.
- Check for continuity between air regulator harness connector terminal 2 and earth.

NG

OK

Faulty harness or connectors.

C

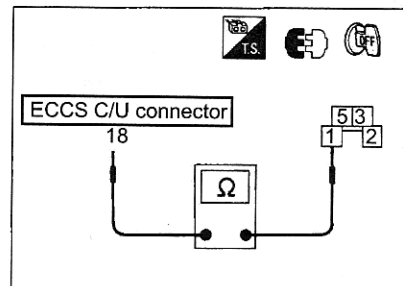

C

Output signal circuit inspection

- Place ignition switch to OFF position.
- Disconnect ECCS C/U harness connector.
- Check for harness continuity between ECCS C/U terminal 18 and fuel pump relay terminal 1.

NG

OK

Inspect the following:
 Continuity between ECCS C/U and fuel pump relay.

TO D

D

Control signal inspection

- Measure voltage between ECCS C/U terminal 18 and earth.
Within 5 sec after ignition switch is placed to ON position: Approx. 1V
5 sec after ignition switch is placed to ON position: Power voltage

NG

OK

Repair and inspect ECCS C/U power supply and ground circuit.

Component parts inspection

- Inspect air regulator.

NG

OK

Replace air regulator.

Inspect ECCS C/U terminal for any damage and ECCS C/U connector connections.

D

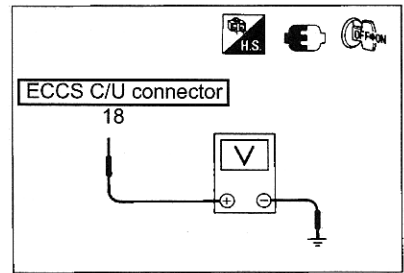

12. POWER STEERING OIL PRESSURE SIGNAL CONTROL CIRCUIT DIAGRAM RB25DE / RB25DET ENGINE

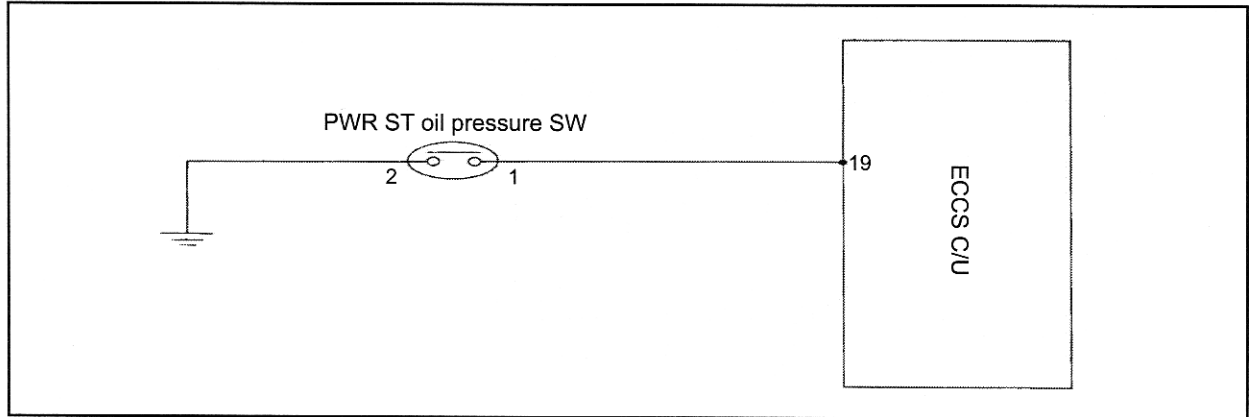

A

Function inspection

- Place ignition switch in the ON position.
- Inspect using "PWR ST SIG" in function test mode. OR
- Stop the engine.
- Use "DATA MONITOR" to inspect PWR ST hydraulic pressure switch signal.

When neutral:	OFF
When steered:	ON

- Start the engine.
- Use CONSULT or tester to measure the voltage between ECCS C/U terminal 19 and earth.

When steered:	Approx. 0V
Other:	Power voltage

OK
FINISH

A

◆ POWER ST SIG ◆

PRESS START WHILE FULLY STEERING THE STEERING WHEEL.

PASS	START
------	-------

A

★ MONITORING ★ NO FAULT

CAS.PM (POS)	862rpm
IGNITION SIGNAL	OFF

RECORD

B

NG

Input signal circuit inspection

- Place ignition switch in the OFF position.
- Remove ECCS C/U harness connector.
- Remove power steering hydraulic pressure switch harness connector.
- Check for harness continuity between ECCS C/U terminal 19 and power steering hydraulic pressure switch terminal 1.

NG
Faulty harness or connectors.

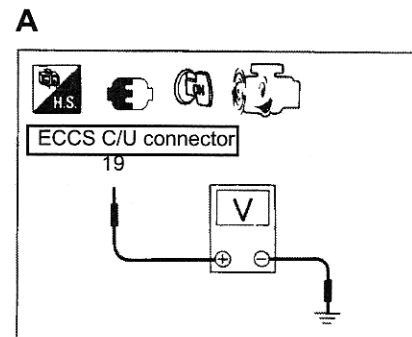

C

Ground circuit inspection

- Check for continuity between power steering hydraulic pressure switch terminal 2 and engine earth.

NG
Faulty harness or connectors.

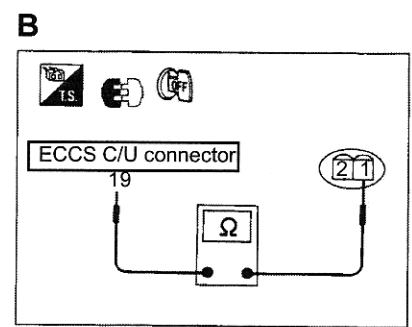

13. COMPONENT PARTS INSPECTION

1. Crank angle sensor

- Remove crank angle sensor from the engine. (leave crank angle sensor harness connector connected).
- Place ignition switch in the ON position.
- Turn the crank angle sensor shaft slowly by hand and check the voltage between terminal 2, 3 and earth.
Crank angle sensor terminal 2 ~ earth (1° signal):
Approx. 0.1V or 5V
Crank angle sen terminal 1 ~ earth (120° signal):
Approx. 0.1V or 5V
- If NG replace the crank angle sensor.
- After inspection erase self-diagnosis result and make sure code No. 11 is not displayed.

Caution:

Remove the fuse or disconnect the connector to avoid injector from operating.

Abnormality may be detected by self-diagnosis mode if the crank angle sensor shaft is not turned smoothly.

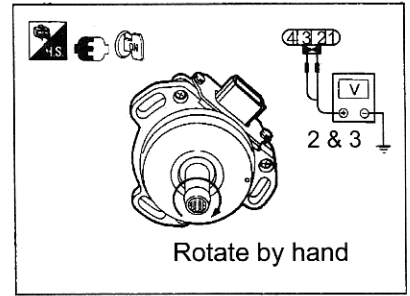

2. Air flow meter

- Remove air flow meter from the engine.
- Apply battery voltage directly between air flow meter terminal +5 and terminal -3 and blow air to hot wire.
Check for any change in output voltage between terminal +2 and terminal -4.
When air is not blown (V): Approx. 0.8
When air is blown (V): Approx. 2
- If NG replace air flow meter OR check for any damage with the hot wire.
- After inspection erase self-diagnosis result and make sure code No. 12 is not displayed.

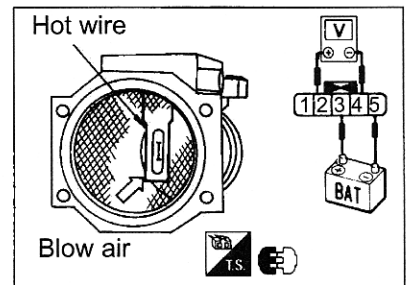

3. Water temperature sensor

- Disconnect engine temperature sensor harness connector.
- Measure the resistance between engine temperature sensor harness terminal 1 and 2.
Coolant water temperature at 20°C (kΩ): Approx. 2.5
Coolant water temperature at 80°C (kΩ): Approx. 0.3
- If NG replace engine temperature sensor.
- After inspection erase self-diagnosis result and make sure code No. 12 is not displayed.

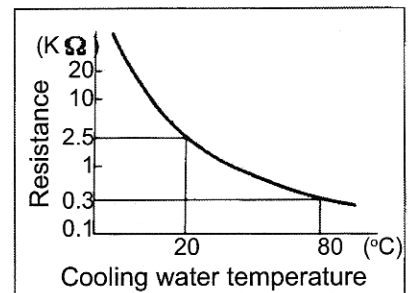

4. Ignition coil

- Disconnect ignition coil harness connector.
- Measure the resistance between following terminals:
Primary coil resistance (1~2) (Ω): Approx. 0.6 ~ 0.9
- If NG replace ignition coil.

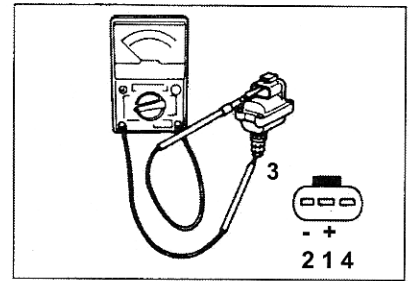

5. Power transistor

- Disconnect power transistor harness connector.
- Measure the resistance by inserting analog type circuit tester inspection rod - and + to power transistor terminals.

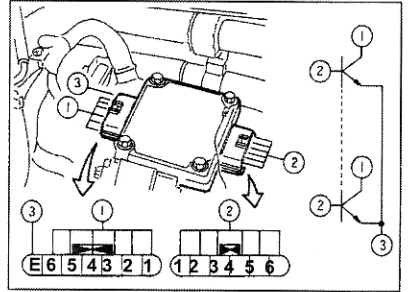

1 - 3	+ / - $\infty \Omega$ - / + $\infty \Omega$
2 - 3	+ / - $\infty \Omega$ > - / + 0 or not $\infty \Omega$
1 - 3	+ / - 0 or not $\infty \Omega$ < - / + $\infty \Omega$

- If NG replace power transistor.

6. Fuel pump

- Disconnect fuel pump harness connector.
- Measure the resistance between fuel pump terminal 1 and 3.
Resistance (Ω): Approx. 0.4 ~ 0.7
- Check for operation by directly applying power voltage between the following terminals:
Connect terminal 3 to + side, terminal 1 to - side.

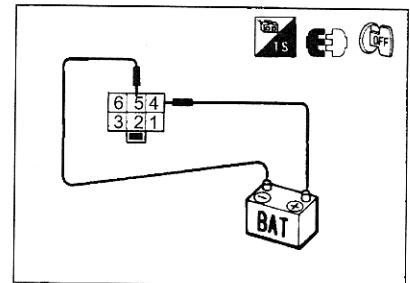

Caution:

Care must be taken to connect battery to correct sides.

- If NG replace fuel pump.

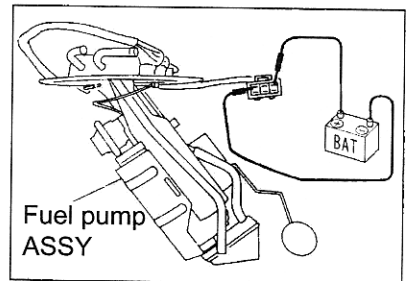

7. Throttle valve switch

- Warm up the engine.
- Disconnect throttle valve switch connector and measure the resistance between throttle valve switch terminals.

(Idle contact point)

Condition	Between throttle valve switch terminals 2 and 1
Accelerator pedal is not pressed	0 Ω
Accelerator pedal pressed	$\infty \Omega$

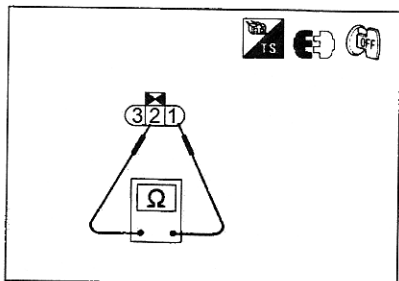

- If NG repair throttle valve switch.

Adjustment

Idle contact point touch rev (rpm): 750 ~ 1050

- Adjust if the touch rev is not within the range above.
- Disconnect throttle valve switch connector and loosen the bolt.
- Gradually increase the engine rev so idle contact point is ON (Resistance between terminal 2 and 1 is 0Ω) at above engine speed. Move throttle valve switch unit to touch point and tighten the bolt.
- Install throttle valve switch connector.
- Race the engine a few times and check that the idle rev is within standard value range.

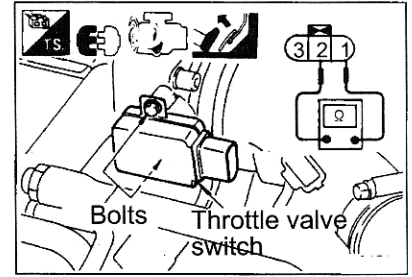

8. Throttle sensor

- Disconnect throttle sensor connector.
- Measure the resistance between throttle sensor terminal 2 and 3.
 Accel pedal not depressed: Approx. 0.4
 Accel pedal depressed to half way: Approx. 0.4~5
 Accel pedal fully depressed: Approx. 5
- If NG replace throttle valve switch.
- After inspection erase self-diagnosis result and make sure code No. 43 is not displayed.

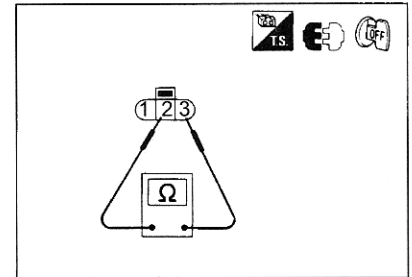

9. AAC valve

- Inspect the resistance of AAC valve.
Resistance (Ω): Approx. 9 ~ 10
- Check the plunger and inspect switch.
- Inspect spring for any damage.
- If NG replace AAC valve.

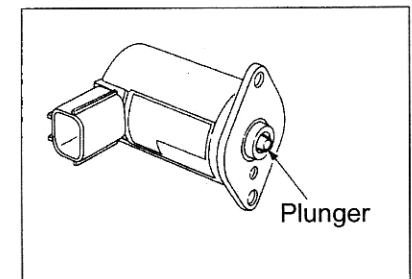
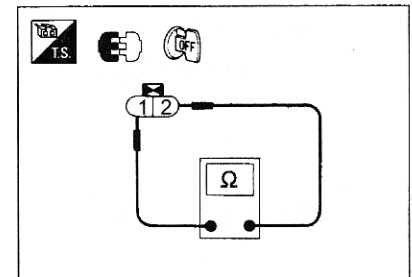

10. FICD solenoid

- Measure the resistance of FICD solenoid.
Resistance (Ω): Approx. 22 ~ 23
- Plunger and switch inspection.
- Inspect spring for any damage.
- If NG replace FICD solenoid.

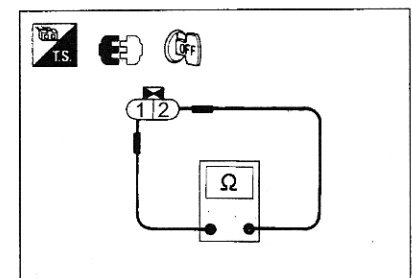

11. Air regulator

Static characteristic inspection

- Visually inspect the shutter opening degree.
Temperature range (°C)
Below -20°C: Fully open
20°C: Half open
Over 60°C: Fully closed

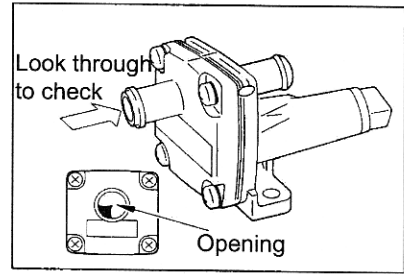

Dynamic characteristic inspection

- Check the change in shutter opening degree when the terminals are energized with the battery. The shutter should open gradually within 7 minutes (surrounding area temperature at approx. 20°C).
(Reference)
Heater resistance value (Ω): 70 ~ 80 at 20°C
- If NG replace the air regulator.

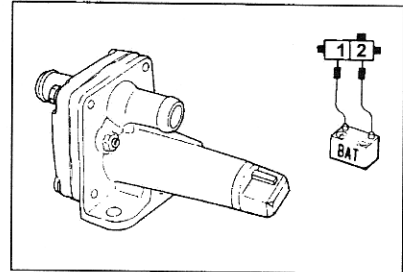

12. Injector

- Remove injector harness connector.
- Measure the resistance between each injector cylinder terminal 1 and 2.
Resistance (Ω): Approx. 1.3
- If NG replace injector.

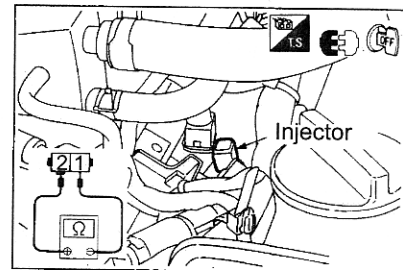

13. Ignition relay & Inhibitor relay

- Directly apply power voltage between terminal 1 and terminal 2.
- Check for continuity between terminal 3 and terminal 4, 6 and 7.
When voltage applied (between 3 & 4): Not present
(between 6 & 7): Present
No voltage applied (between 3 & 4): Present
(between 6 & 7): Not present
- If NG replace relay.

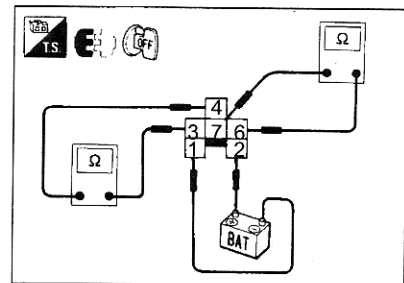

14. Power steering hydraulic pressure inspection

- Remove power steering hydraulic pressure switch harness connector.
- Check for continuity between the terminals.
Steering wheel steered: Continuity present
Steering wheel not steered: Continuity not present
- If NG replace power steering hydraulic pressure switch.

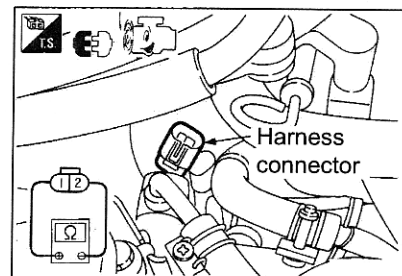

EN8 SYSTEM FAULT DIAGNOSIS

1. FUEL PUMP SYSTEM INSPECTION
CONTROL CIRCUIT DIAGRAM RB26DETT ENGINE

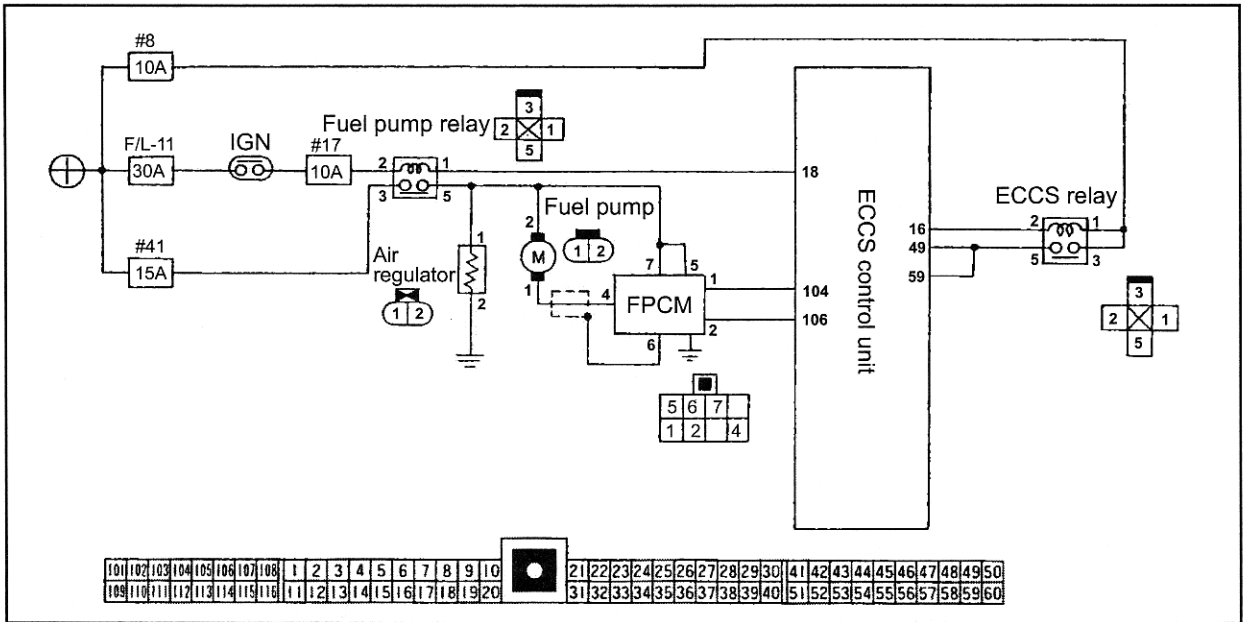

A

System inspection

- Select "Fuel pump" in function test.
- Check for pulsation on the fuel hose.
- Place ignition switch in the ON position.
- Check for fuel pump operation noise. The fuel pump will operate for 5 sec after ignition switch is placed to ON.

OK

NG

Fuel pressure inspection
 If NG replace faulty parts.

A

◆ FUEL PUMP ◆

IS THERE A PULSATION EVERY 3 SECONDS WHEN THE FUEL TUBE IS HELD? OR CAN YOU HEAR THE OPERATION NOISE OF THE FUEL PUMP RELAY?

PASS NO YES

B

Relay power inspection

- Place ignition sw in OFF position.
- Disconnect pump relay connector.
- Place ignition sw to ON position.
- Measure voltage between earth terminal and the terminal 2 & 3 using the tester.

Finish

NG

OK
 TO C

Check the following:
 #17 10A fuse
 #41 15A fuse
 Harness continuity between the pump relay and the fuse.
 If NG replace faulty harness or the connector.

A

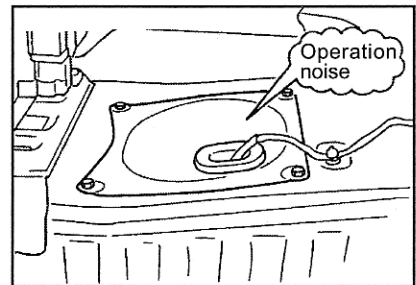

B

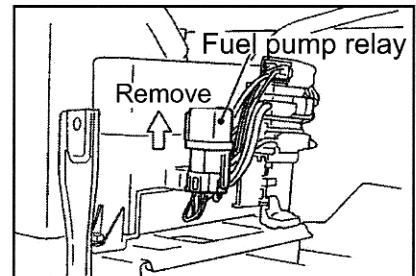

C

Power circuit inspection

- Place ignition sw in the OFF position.
- Disconnect ECCS C/U connector.
- Connect pump relay connector.
- Place ignition sw in the ON position.
- Measure voltage between ECCS C/U connector side terminal 18 and the earth.

NG

OK

D

Harness continuity inspection

Disconnect the pump relay connector and check for continuity between pump relay terminal 1 and ECCS C/U terminal 18. If NG replace faulty harness or the connector.

B

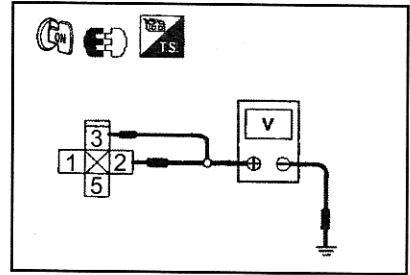

C

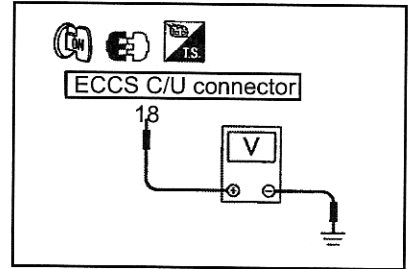

D

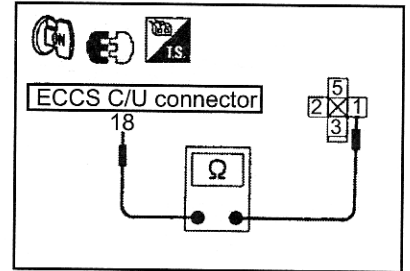

E

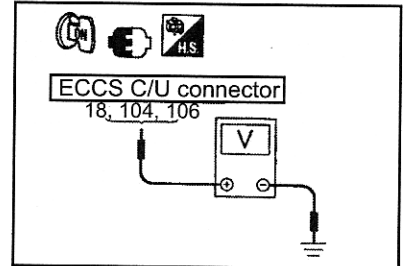

F

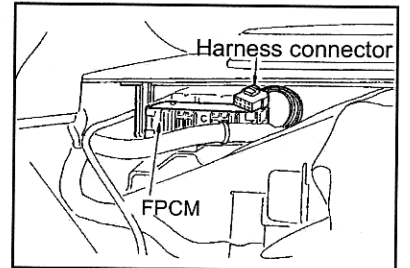

F

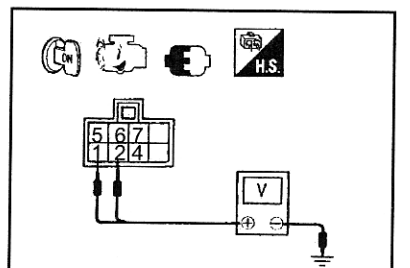

E

Control signal inspection

- Place ignition sw in the OFF position.
- Connect ECCS C/U connectors.
- Place ignition sw in the ON position.
- Check the voltage between ECCS C/U connector 18 and the earth.

5 sec after placing ignition sw in ON position:
Approx. 1V

Other: Battery voltage

- Check the voltage between ECCS C/U connector 104 & 106 and the body earth.

5 sec after placing ignition sw in ON position:
Approx. 2V

Other: Approx. 0V

5 sec after engine start: Approx. 4V

Other: Approx. 2V

NG

OK

ECCS C/U power supply inspection using CONSULT.

F

FPCM input signal inspection

- Check voltage between FPCN connector terminal 1 & 2 and the earth.

5 sec after placing ignition sw in ON position:
Approx. 2V

Other: Approx. 0V

5 sec after engine start: Approx. 4V

Other: Approx. 2V

NG

OK

TO H

TO G

G
Harness continuity inspection
 Check harness continuity between ECCS C/U connector terminal 104 & 106 and FPCM connector terminal 1 & 2. If NG replace faulty harness or the connector.

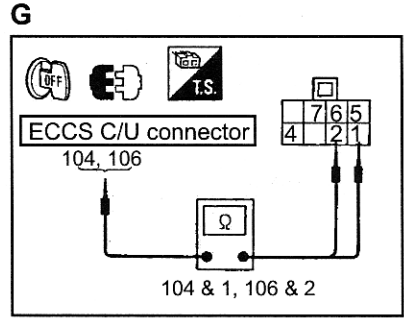

H
Harness continuity inspection - 1

- Place ignition sw in the OFF position.
- Disconnect connectors for fuel pump, pump relay and FPCM connector.
- Check the harness continuity between the fuel pump harness connector terminal 2 and the pump relay harness connector side terminal 5.

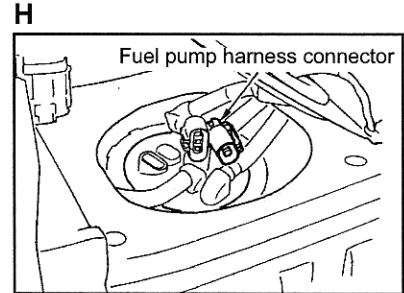

OK

I
Harness continuity inspection - 2

- Check the harness continuity between the fuel pump harness connector terminal 1 and the FPCM harness terminal 4.

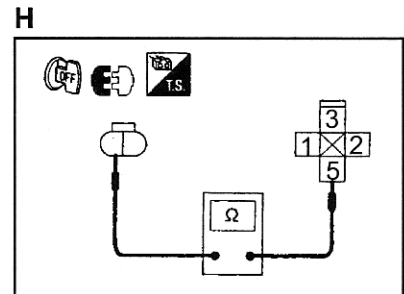

OK

Faulty harness or connector

J
Harness continuity inspection - 3

- Check the harness continuity between FPCM connector 5 & 7 and pump relay harness connector terminal 5.

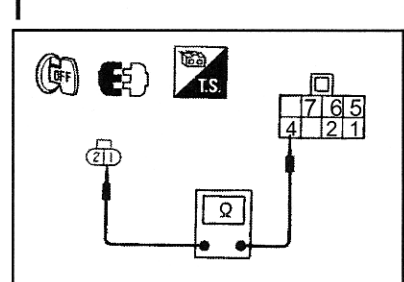

OK

Faulty harness or connector

K
Earth circuit inspection

- Check the harness continuity between FPCM connector 6 and the earth.

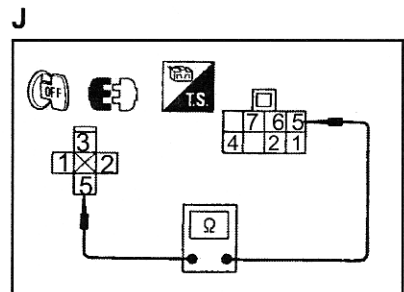

OK

Faulty harness or connector

Component parts inspection

- Check fuel pump and the fuel pump relay.

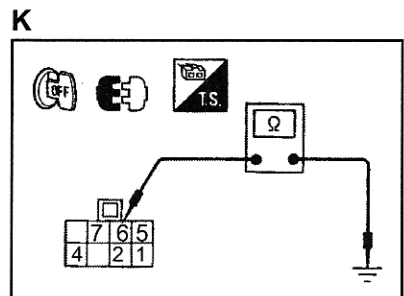

OK

Inspect ECCS C/U terminal for any damage or ECCS C/U connectors.

2. INJECTOR SYSTEM INSPECTION
CONTROL CIRCUIT DIAGRAM RB26DETT ENGINE

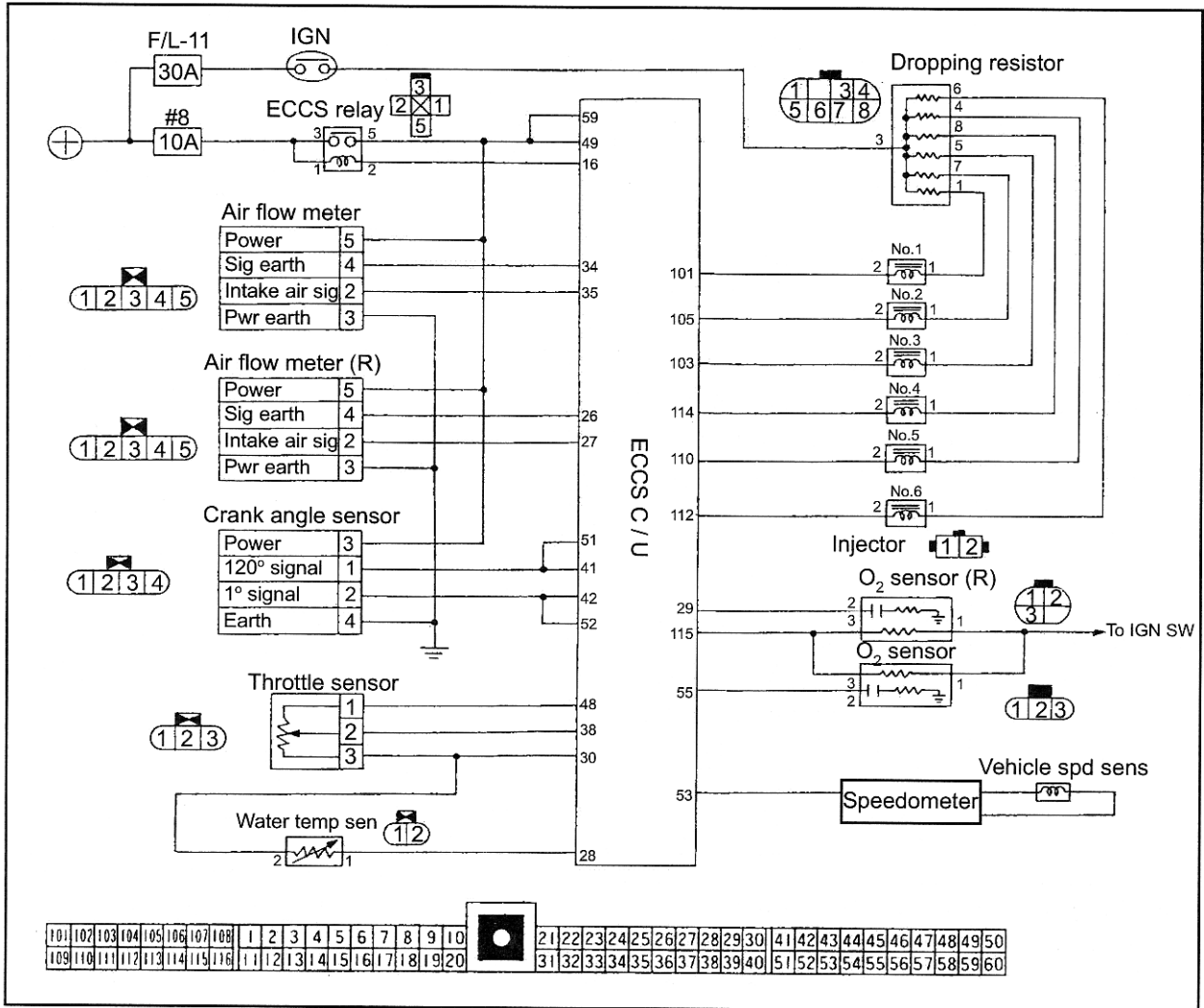

A

System inspection 

- Start the engine.
- Carry out the "Power balance" inspection in function test mode. OR "Power balance" in active test.

Control signal inspection 

- Check the voltage between each injector harness connector terminal 2 and earth.

IGN sw in ON: Battery voltage

When cranking: Approx. 10V

While engine is running:
 The battery voltage will decrease as the engine rev increase. (voltage will decrease approx. 0.2V to 2000rpm rev increase).

OK

NG
 TO B

Finish

A

◆PWR BALANCE◆
 STOP INJECTOR DRIVE TO INSPECT EACH CYLINDER FOR BALANCE. TURN OFF AIR CONDITIONER AND LIGHTS.

PASS START

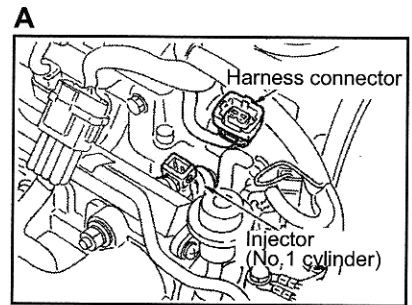

B

Power supply inspection

- Place ignition sw in the OFF position.
- Disconnect the dropping resistor harness connector.
- Measure voltage between dropping the resistor harness side connector terminal 3 and the earth.

NG

OK

Check the following:
Check for harness continuity between the fuse and the dropping resistor terminal 3.
If NG replace faulty harness or connector.

A

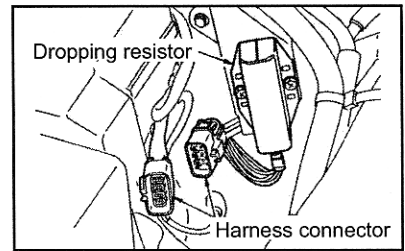

A

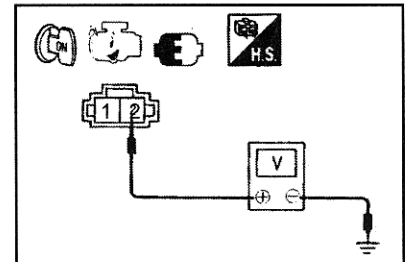

B

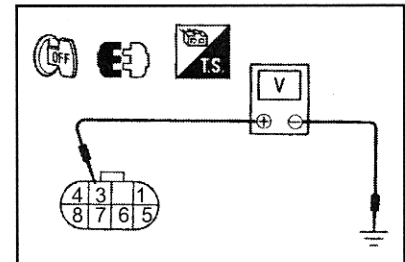

C

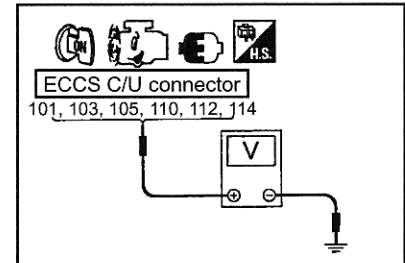

C

Control signal inspection

- Connect dropping resistor connectors.
- Place ignition sw in the ON position.
- Check the voltage between ECCS C/U connector 101, 103, 105, 110, 112, 114 and the earth.
- Check the voltage between ECCS C/U connector 101, 103, 105, 110, 112, 114 and the body earth.

IGN sw in ON position: Battery voltage
While cranking: Approx. 10V
The battery voltage will decrease as the engine rev increase. (voltage will decrease approx. 0.2V to 2000rpm rev increase).

NG

OK

Check the following:
Crank angle sensor system
Air flow meter system
Water temperature sensor system
O₂ sensor signal system
Throttle sensor system
ECCS C/U power
Vehicle speed sensor system
Ignition sw (start) signal
If NG replace the faulty parts.

TO D

D

Harness continuity inspection - 1

- Place ignition sw in the OFF position.
- Disconnect dropping resistor and injector harness connectors.
- Check the harness continuity between following terminals:

Dropping resistor	Injector
1	1 (No.1)
7	1 (No.2)
5	1 (No.3)
8	1 (No.4)
4	1 (No.5)
6	1 (No.6)

NG

OK

Faulty harness or connector

D

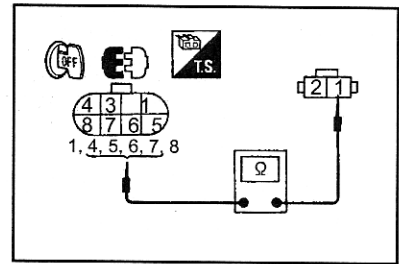

E

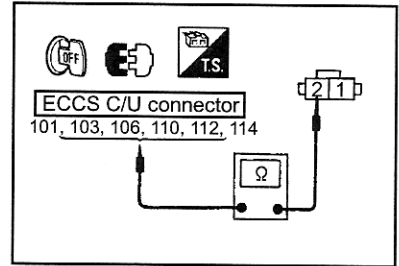

E

Harness continuity inspection - 2

- Disconnect ECCS C/U harness connector.
- Check the harness continuity between following terminals:

ECCS C/U	Injector
101	2 (No.1)
105	2 (No.2)
103	2 (No.3)
114	2 (No.4)
110	2 (No.5)
112	2 (No.6)

NG

OK

Faulty harness or connector

Component parts inspection

- Check injector and dropping resistor.

NG

OK

Replace faulty parts

Inspect ECCS C/U terminal for any damage or ECCS C/U connectors.

3. IGNITION SYSTEM INSPECTION
CONTROL CIRCUIT DIAGRAM RB26DETT ENGINE

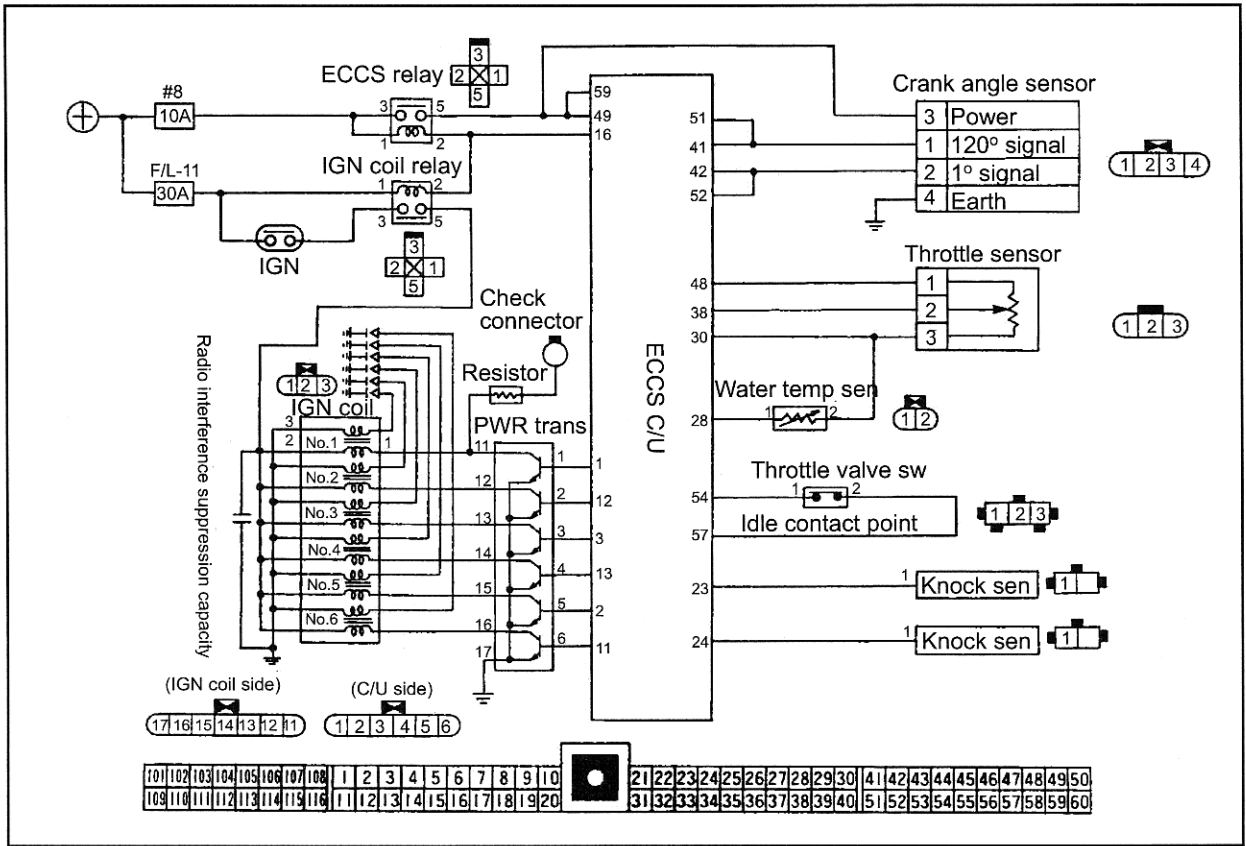

A

Overall system inspection

- Place ignition sw in the START position.
- Make sure all cylinders are firing.

NO TO E

YES

- Carry out "Power balance" in function test mode. OR
- Carry out "Power balance" in active test.
- Check to make sure the engine rev will not decrease momentary.

OK Finish

A

◆ POWER BALANCE ◆
 STOP INJECTOR DRIVE TO INSPECT EACH CYLINDER FOR BALANCE. TURN OFF AIR CONDITIONER AND LIGHTS.

PASS

START

B

Circuit function inspection

- Place ignition sw in the OFF position.
- Disconnect ignition coil harness connector.
- Place ignition sw in the ON position.
- Check the battery voltage between terminal 2 and body earth.

NG TO F

OK

TO C

B

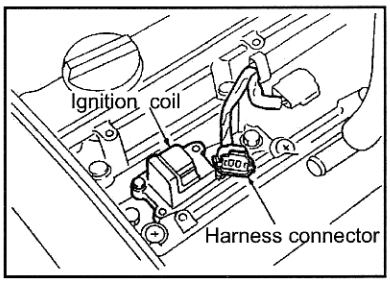

C

Ground circuit inspection

- Place ignition sw in the OFF position.
- Check continuity between terminal 3 and earth.

NG

OK

Replace faulty terminal or connector.

C

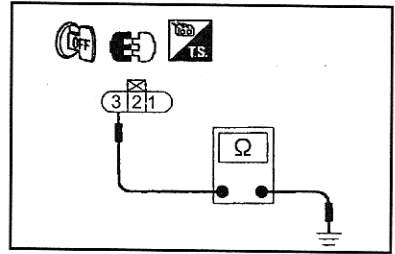

D

Output circuit inspection

- Place ignition sw in the OFF position.
- Disconnect power transmission unit harness connector.
- Inspect between following terminals for continuity:
Between each ignition coil terminal 1 and power transistor terminal 11, 12, 13, 14, 15 and 16.

NG

OK

Replace faulty terminal or connector.

D

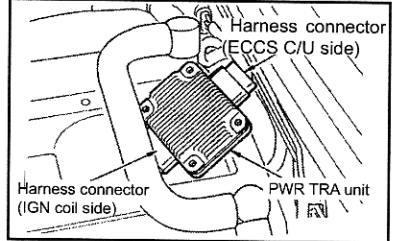

D

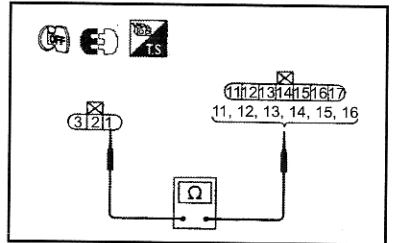

E

Function inspection

- Place ignition sw in the OFF position.
- Remove ignition coil harness connector.
- Place ignition sw in the ON position.
- Check for continuity between terminal 2 and body earth.

NG

TO C

OK

E

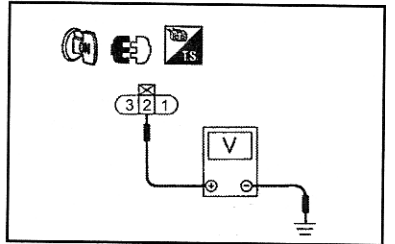

F

Power inspection

- Place ignition sw in the OFF position.
- Remove ignition coil relay connector.
- Place ignition sw in the ON position.
- Check for continuity between terminal 1 & 3 and body earth.

NG

Inspect the following:
Fusible link.
Ignition sw.
Harness continuity between ignition coil relay and ignition sw.
Harness continuity between ignition coil relay and the battery.
If NG replace faulty harness or connector.

F

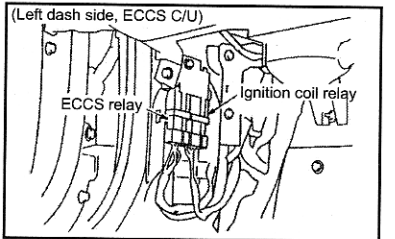

F

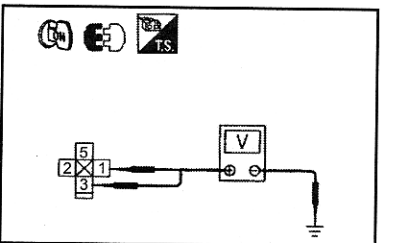

G

Earth circuit inspection

- Place ignition sw in the OFF position.
- Check continuity between each coil terminal 2 and ignition coil relay harness terminal 5.

NG

OK

Replace faulty terminal or connector.

G

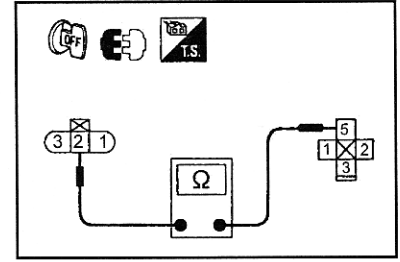

H

Output circuit inspection

- Remove ECCS C/U connector.
- Check for harness continuity between ECCS C/U terminal 16 and ignition coil relay harness terminal 2.

NG

OK

Inspect the following:
 ECCS relay
 Harness continuity between ECCS relay and ignition coil relay.
 If NG replace faulty harness or connector.

H

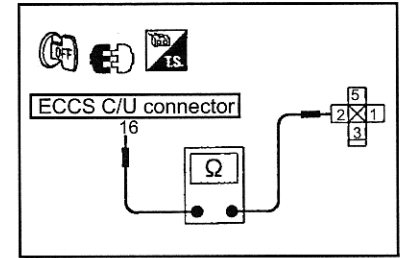

Component parts inspection

- Check ignition coil relay and ignition coil.

NG

OK

Replace faulty parts

Inspect ECCS C/U terminal for any damage or ECCS C/U connectors.

4. AAC VALVE SYSTEM
CONTROL CIRCUIT DIAGRAM RB26DETT ENGINE

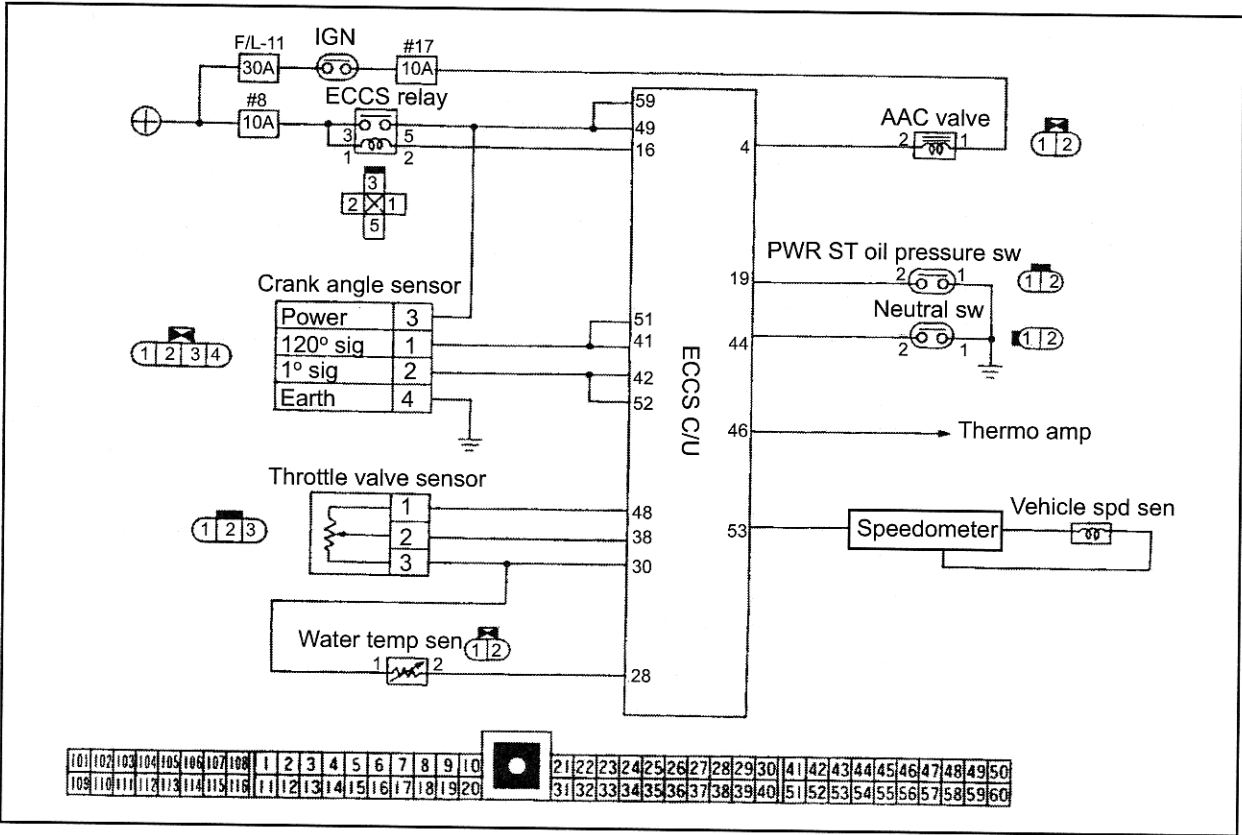

System inspection - 1

- Warm-up the engine.
- Check idle rev (rpm): 950+/-50

NG

OK

Base rev inspection

- Check if ECCS C/U idle rev adjustment volume knob is turned fully left.
- Check if engine rev id at 900rpm when the AAC valve harness connector is removed.

A

◆ AAC VALVE ◆

PRESS START AFTER
TURNING OFF AIR
CONDITIONER AND
LIGHTS.

PASS START

A

System inspection - 2

- Carry out "AAC valve" in function test mode. OR
- Carry out "AAC valve opening" in active test mode.
- Check if engine rev will change when "Qu" or "Qd" is pressed to change the valve opening.
- There must be more than 150rpm change when control duty ratio is between 80~20%.

A

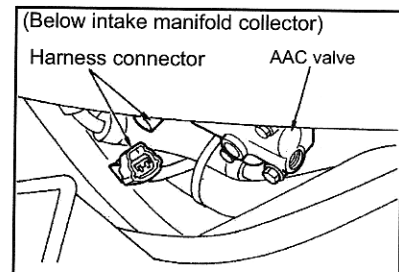

Continue to next page

- Make sure the engine rev is at 900rpm when AAC valve harness connector is removed.
- If the value is not at correct rev, adjust engine rev to 900rpm using the idle adjust screw.

OK

NG

Inspect the following input signal systems:

- Crank angle sensor
- Water temperature sensor
- Throttle sensor
- Vehicle speed sensor system
- Neutral signal
- Power steering oil pressure signal
- Air conditioner sw signal

B

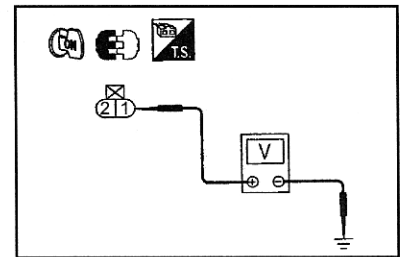

C

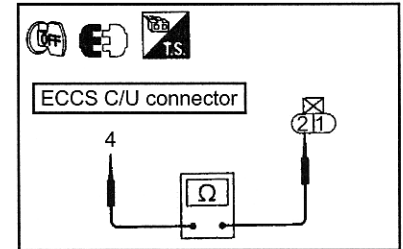

B

Power inspection

- Place ignition sw in the OFF position.
- Remove AAC valve harness connector.
- Place ignition sw in the ON position.
- Check for battery voltage between AAC valve harness connector terminal 1 and earth.

Finish

NG

OK

Inspect the following:

- #17 10A fuse
- Harness continuity between AAC valve and fuse.

If NG replace the faulty harness.

C

Ground circuit inspection

- Place ignition sw in the OFF position.
- Remove ECCS C/U harness connector.
- Check for continuity between ECCS C/U connector terminal 4 and AAC valve harness connector terminal 2.

NG

OK

Faulty harness or connector.

Component parts inspection

- Check AAC valve component parts.

NG

OK

Replace AAC valve

Inspect ECCS C/U terminal for any damage or ECCS C/U connectors.

5. INJECTION PULSE
CONTROL CIRCUIT DIAGRAM RB26DETT ENGINE

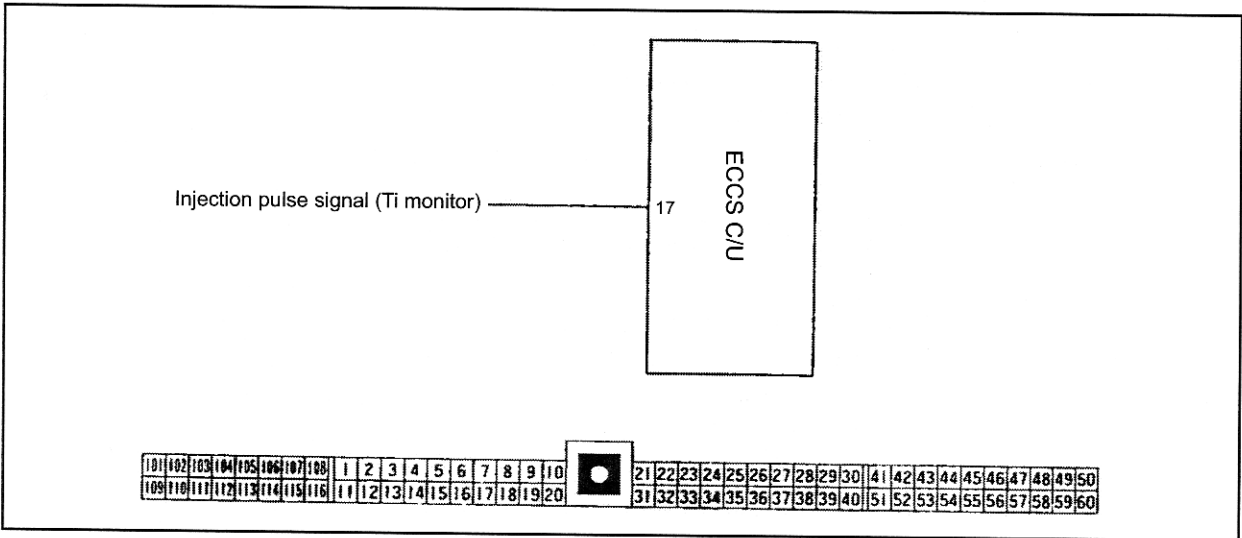

A

Injection pulse monitor (Ti monitor) signal inspection

- Check the power voltage between ECCS C/U terminal 17 and the body earth with ECCS C/U connector connected.

When ignition sw in ON: Power voltage
While cranking or engine running:
The power voltage will decrease as the engine rev increase.

Inspection using oscilloscope

- Injector pulse monitor (Ti monitor) is an actual injector waveform from ECCS C/U result.

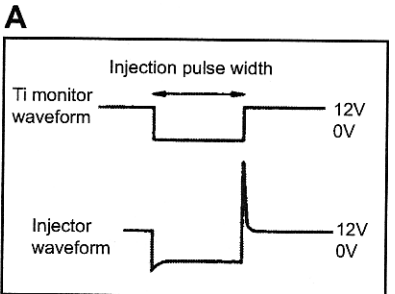
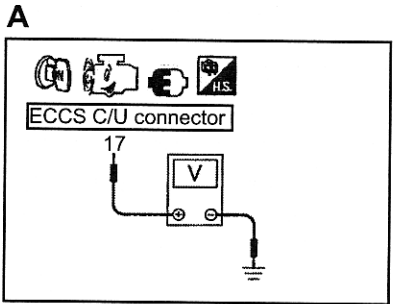
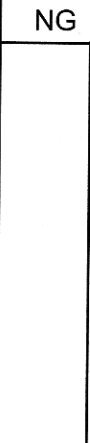

OK
Finish

Injector input signal system inspection
Inspect injector system.
If NG replace or repair faulty parts.

6. BOOST CONTROL
CONTROL CIRCUIT DIAGRAM RB26DETT ENGINE

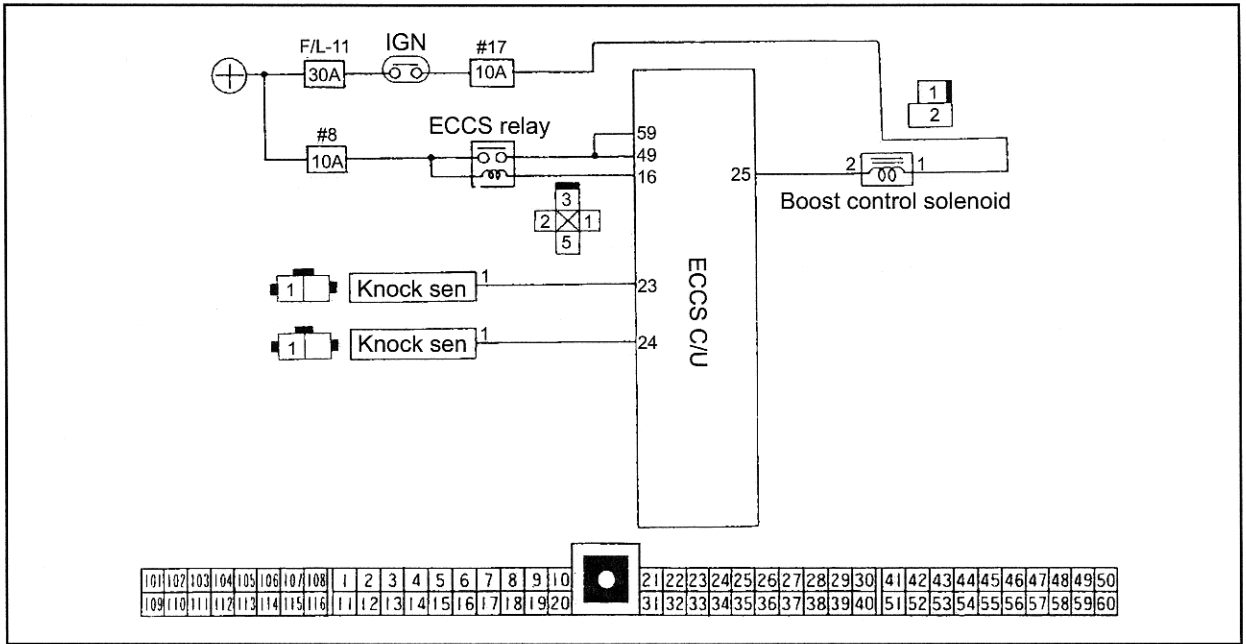

A
System inspection

- Start the vehicle to warm up the engine.
- Check if the boost control solenoid operation noise can be heard when the engine rev is increased to over approx. 2200rpm.

OK

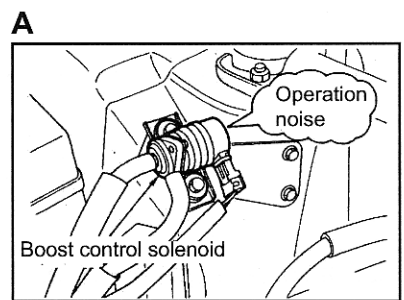

NG

Component parts inspection
 Inspect boost control actuator.
 If NG replace faulty actuator.

OK

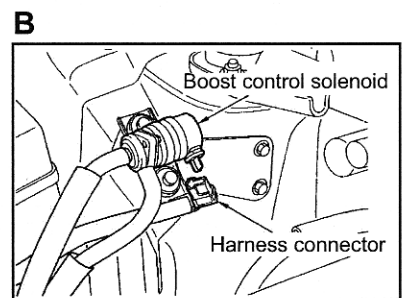

B
Power supply inspection

- Place ignition sw in the OFF position.
- Remove boost control solenoid harness connector.
- Place ignition sw in the ON position.
- Check power voltage between boost control solenoid terminal 1 and body earth.

NG

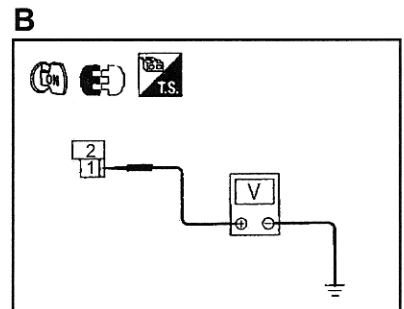

OK

Inspect the following:
 #17 10A fuse
 Harness continuity between control solenoid and the fuse.

TO C

C

Control signal circuit inspection

- Place ignition sw in the OFF position.
- Remove ECCS C/U harness connector.
- Check harness continuity between ECCS C/U connector terminal 25 and boost control solenoid connector terminal 2.

OK

NG

Check for faulty harness or connector.

C

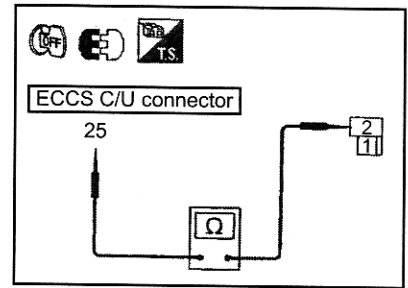

D

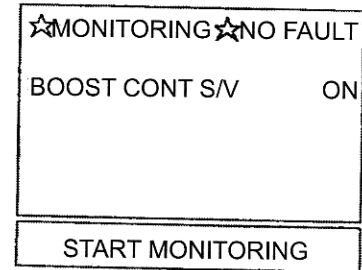

D

Control signal inspection

- Start the engine.
- Check ON-OFF operation using "Boost CONT S/V" in data monitor mode.



OK

Idling: OFF
 When accel pedal is depressed suddenly: ON

- Check power voltage between ECCS C/U terminal 25 and body earth.



Idling: Power voltage
 When accel pedal is depressed suddenly: 1.0V

NG

Check for any disconnected hose or damaged hoses.

D

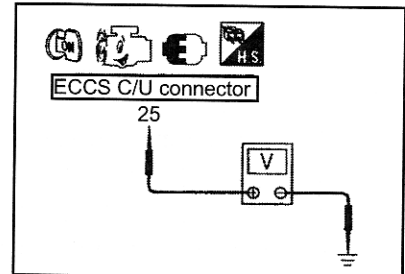

Component parts inspection

- Check AAC valve component parts.

NG

OK

Replace boost control solenoid or actuator.

Inspect ECCS C/U terminal for any damage or ECCS C/U connectors connection.

7. AIR CONDITIONER CUT CONTROL
CONTROL CIRCUIT DIAGRAM RB26DETT ENGINE

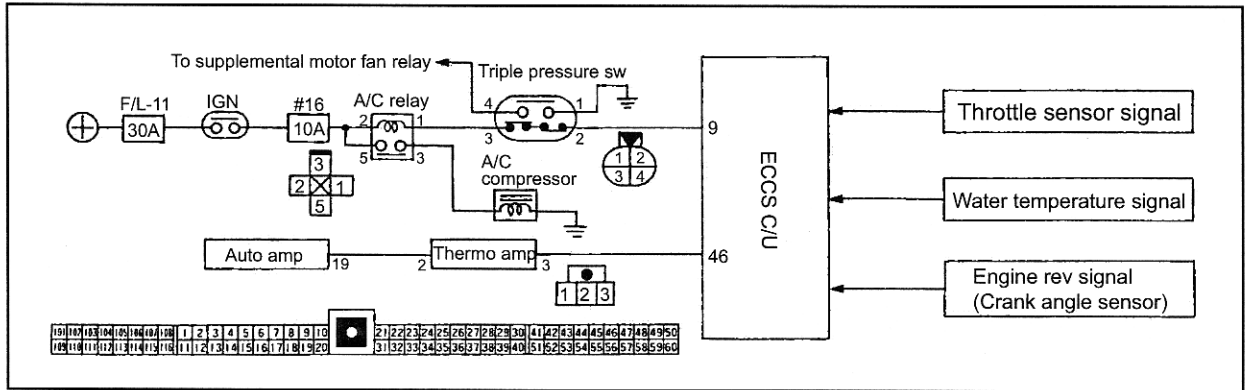

A

Air conditioner sw input signal inspection

- Place the ignition sw in the ON position.
- Carry out the "A/C signal" inspection in data monitor mode.

Air conditioner sw ON:	ON
Air conditioner sw OFF:	OFF

- Check the power voltage between ECCS C/U connector terminal 46 and body earth.

Air conditioner sw ON:	0V
Air conditioner sw OFF:	Power voltage

NG

OK

Inspect harness continuity for triple pressure sw and air conditioner sw. If NG replace or repair faulty parts.

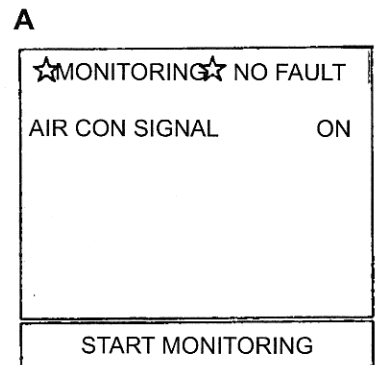

B

A/C relay control signal inspection

- Start the engine.
- Check ON-OFF signal of A/C by carrying out "A/C relay" in data monitor.

Air conditioner sw ON:	ON
Air conditioner sw OFF:	OFF

- Check the power voltage between ECCS C/U connector terminal 9 and body earth.

Air conditioner sw ON:	Approx. 1.0V
Air conditioner sw OFF:	Power voltage

NG

OK

Inspect harness continuity for air conditioner relay. If NG replace or repair faulty parts.

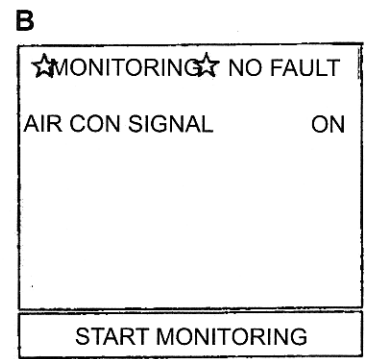
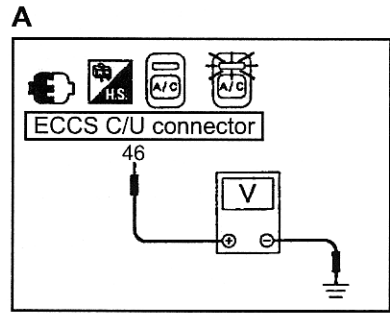

Inspect ECCS C/U terminal for any damage or ECCS C/U connectors connection.

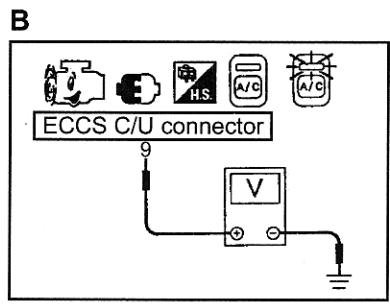

8. THROTTLE VALVE SWITCH SYSTEM
CONTROL CIRCUIT DIAGRAM RB26DETT ENGINE

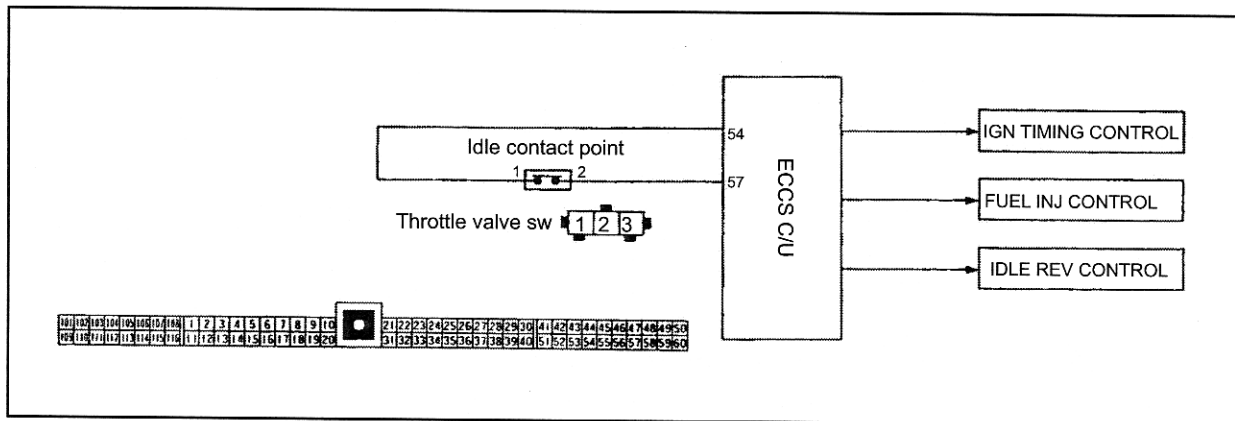

A

System inspection (Idle contact point)

- Start the vehicle to warm up the engine.
- Place ignition sw in the ON position.
- Carry out "Throttle sensor" in function test. OR
- Inspect using data monitor mode.

Acceleration pedal not depressed: ON
 Acceleration pedal depressed: OFF

- Start the vehicle to warm up the engine.
- Place ignition sw in the ON position.
- Check the power voltage between ECCS C/U terminal 54 and body earth.

Accel pedal not depressed: Approx. 11V
 Accel pedal depressed: Approx. 0V

OK

Finish

A

◆ THROTTLE SEN ◆

PRESS START WHILE FULLY OPENING THE ACCELERATOR PEDAL.

PASS START

B

Power inspection

- Place ignition sw in the OFF position.
- Remove throttle valve sw connector.
- Place ignition sw in the ON position.
- Check the power voltage between throttle valve sw harness terminal 2 and body earth.

NG

B

Harness continuity inspection

- Check harness continuity between throttle valve sw terminal 2 and ECCS C/U terminal 57.

OK

TO C

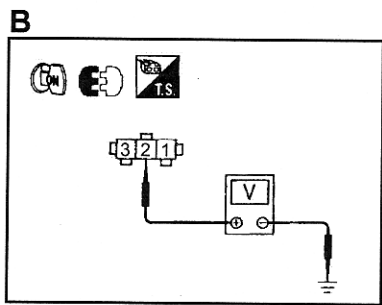
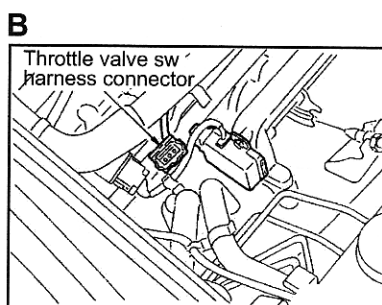
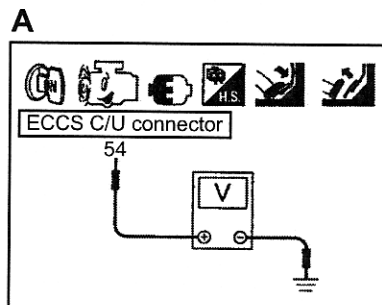

C

Input signal circuit inspection (idle contact point)

- Place ignition sw in the OFF position.
- Remove ECCS C/U connector.
- Remove throttle valve sw harness connector.
- Check for continuity between ECCS C/U terminal 54 and throttle valve sw terminal 1.

NG

Faulty harness or connector.

OK

Component parts inspection

- Check throttle valve sw.

NG

Replace throttle valve sw.

OK

Inspect ECCS C/U terminal for any damage or ECCS C/U connectors connection.

C

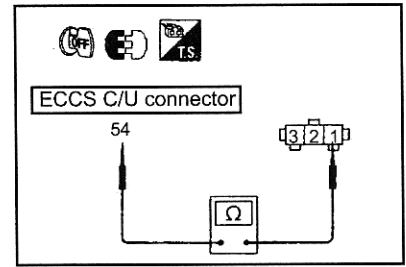

9. O₂ SENSOR HEATER SYSTEM
CONTROL CIRCUIT DIAGRAM RB26DETT ENGINE

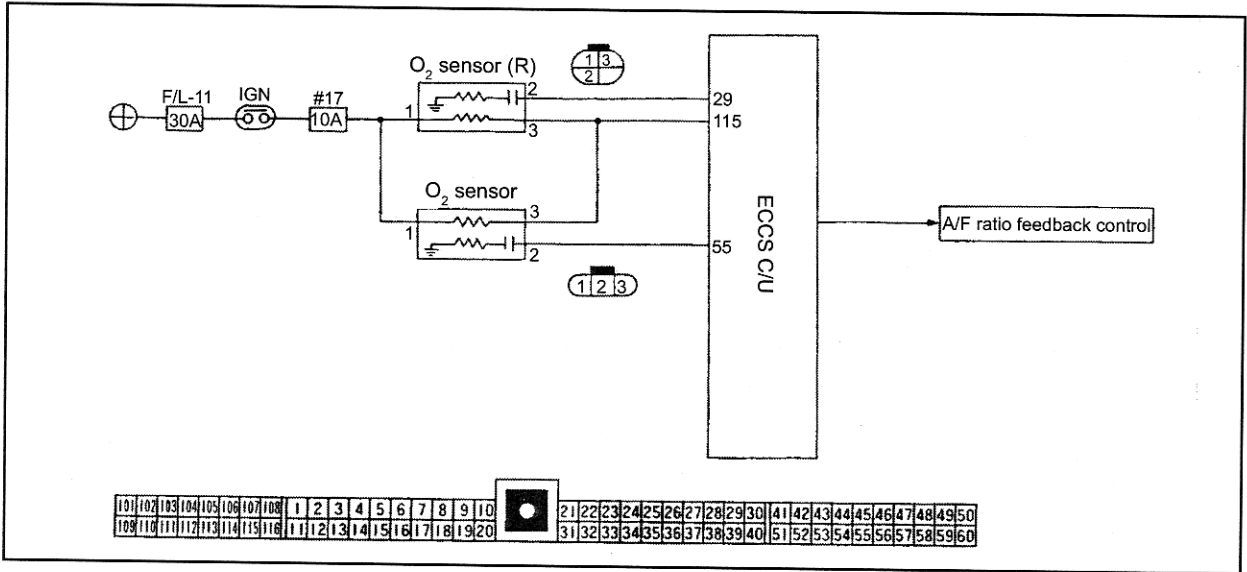

A

Power inspection

- Remove O₂ sensor harness connector.
- Place ignition sw in the ON position.
- Check the power voltage between O₂ sensor harness terminal 1 and body earth.

NG

OK

Faulty harness or connector.

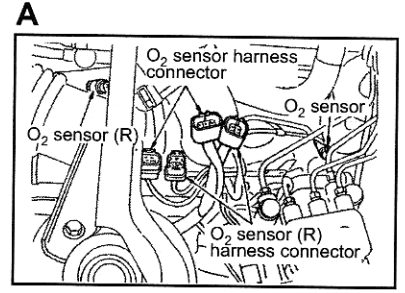

B

Ground circuit inspection

- Place ignition sw in the OFF position.
- Check the harness continuity between ECCS C/U connector terminal 115 and O₂ sensor harness terminal 3.

NG

OK

Faulty harness or connector.

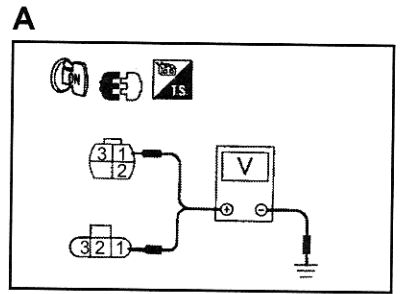

Component parts inspection

- Check O₂ sensor heater.

NG

OK

Replace O₂ sensor.

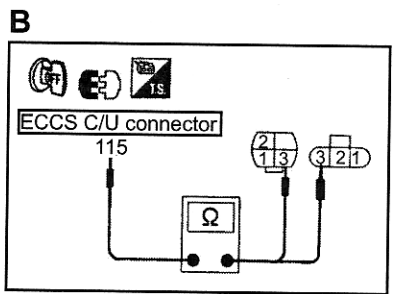

Inspect ECCS C/U terminal for any damage or ECCS C/U connectors connection.

10. VEHICLE SPEED SENSOR SYSTEM
CONTROL CIRCUIT DIAGRAM RB26DETT ENGINE

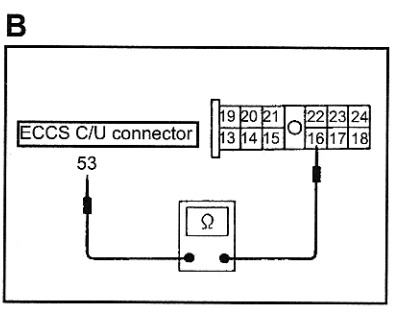
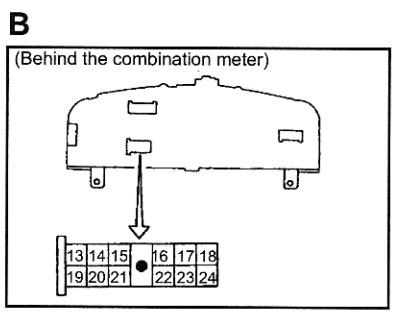
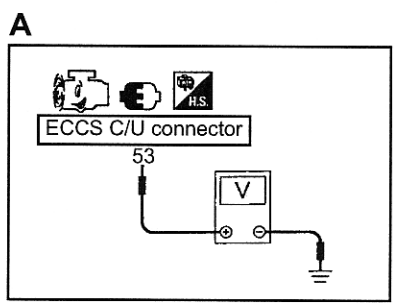
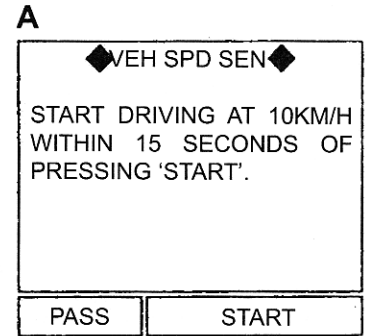
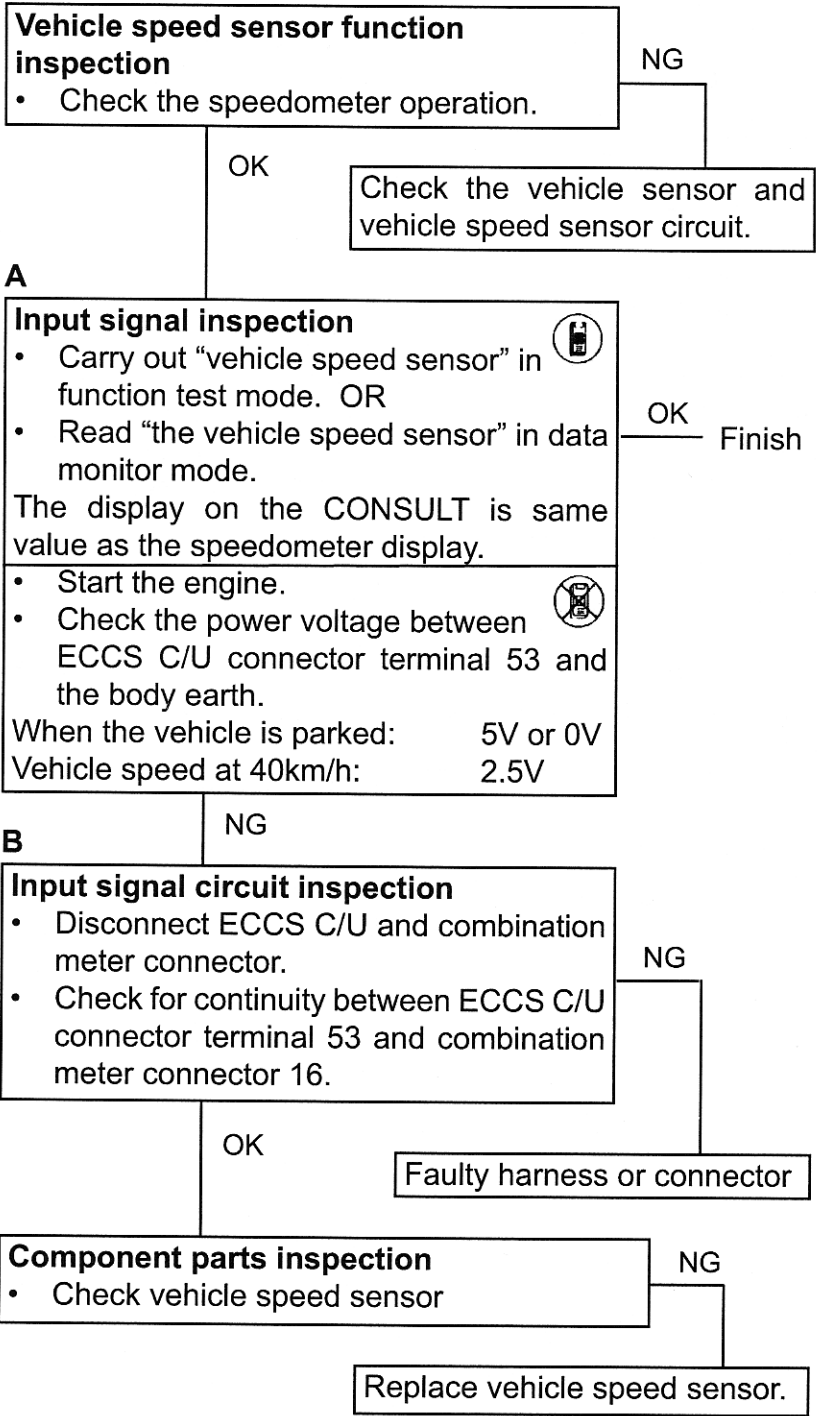
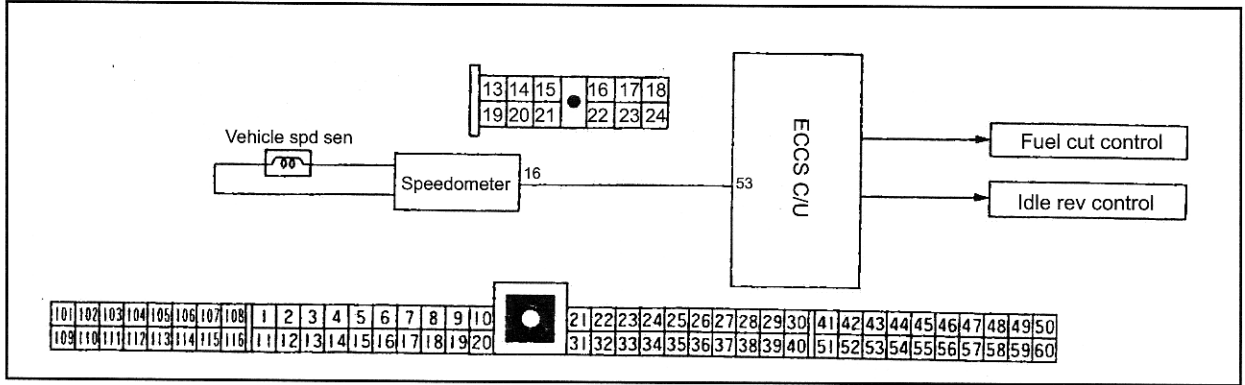

11. IGNITION SWITCH (START) SIGNAL

A

Function inspection 

- Carry out "starter signal" in function test mode. OR
- Carry out "starter signal" in data monitor mode.

IGN sw ON: OFF
IGN sw START: ON

• Place ignition sw in the START. 

• Check the power voltage between ECCS C/U connector terminal 43 and the body earth.

When the ignition in start: Power voltage
Other: Approx. 0V

OK Finish

B

Input signal circuit inspection

- Place ignition sw in the OFF position.
- Remove ECCS C/U and ignition sw harness connector.
- Check for harness continuity between ECCS C/U connector terminal 43 and ignition sw harness connector 5.

NG

NG

OK

Inspect the following:
#3 10A fuse
Continuity between ignition sw and ECCS C/U harness.
If NG replace faulty harness or connector.

Inspect ECCS C/U terminal for any damage or ECCS C/U connectors connection.

A

◆ START SIGNAL ◆

1. Place the shift lever in P or N after fully opening the accelerator pedal.
2. Start the engine directly after pressing "START".

PASS START

A

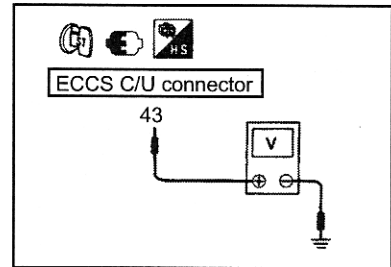

B

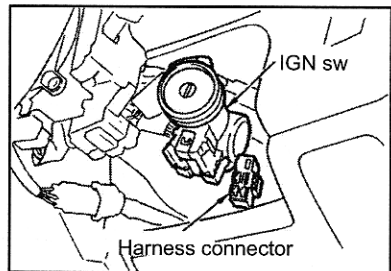

B

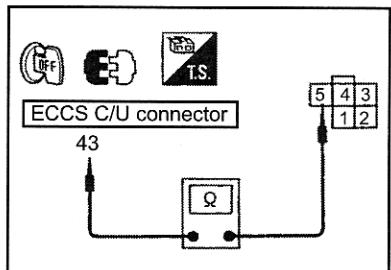

RB26DETT ENGINE

12. POWER STEERING OIL PRESSURE SIGNAL
CONTROL CIRCUIT DIAGRAM RB26DETT ENGINE

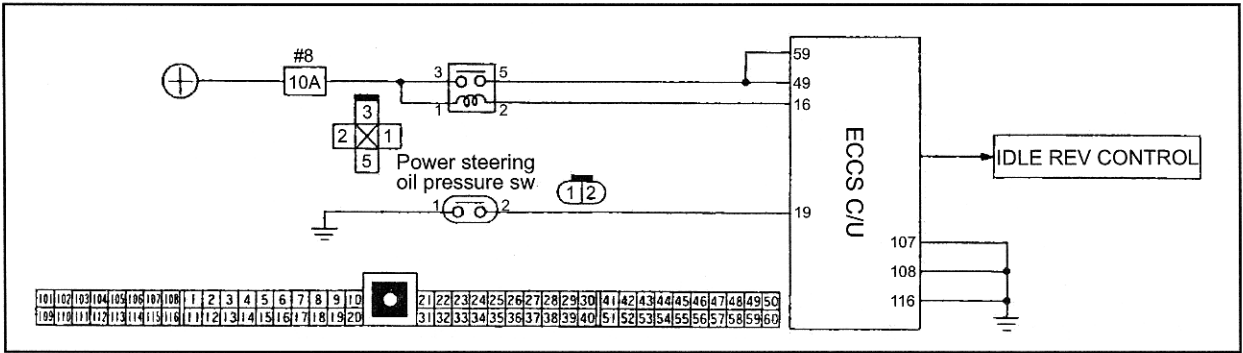

A

Function inspection

- Carry out "power steering signal" in function test mode. OR
- Carry out "power steering oil pressure sw" in data monitor mode.

Steering wheel not steered: OFF
Steering wheel steered: ON

- Start the engine.
- Check the power voltage between ECCS C/U connector terminal 19 and the body earth.

Steering wheel not steered: 4.5V
Steering wheel steered: 0V

OK Finish

A

◆ P/S SIGNAL ◆

PRESS START WHILE STEERING WHEEL FULLY STEERED.

PASS START

B

Input signal circuit inspection

- Place ignition sw in the OFF position.
- Disconnect ECCS C/U connector.
- Remove power steering oil pressure sw harness connector.
- Check for continuity between ECCS C/U connector terminal 19 and power steering oil pressure sw harness connector 2.

NG

Faulty harness or connector.

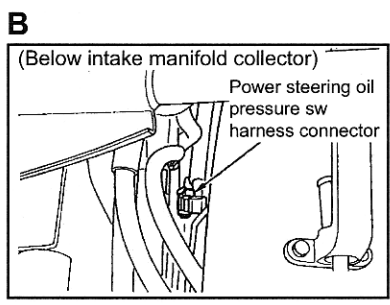
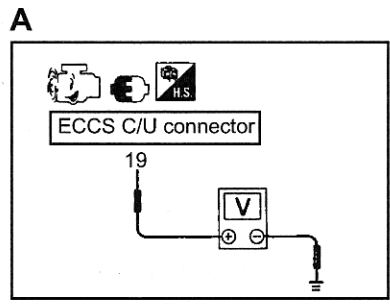

C

Ground circuit inspection

- Check for continuity between power steering oil pressure terminal 1 and body earth.

NG

Faulty harness or connector.

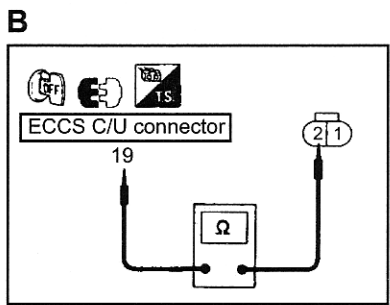

Component parts inspection

- Check power steering oil pressure sw.

13. NEUTRAL SIGNAL
CONTROL CIRCUIT DIAGRAM RB26DETT ENGINE

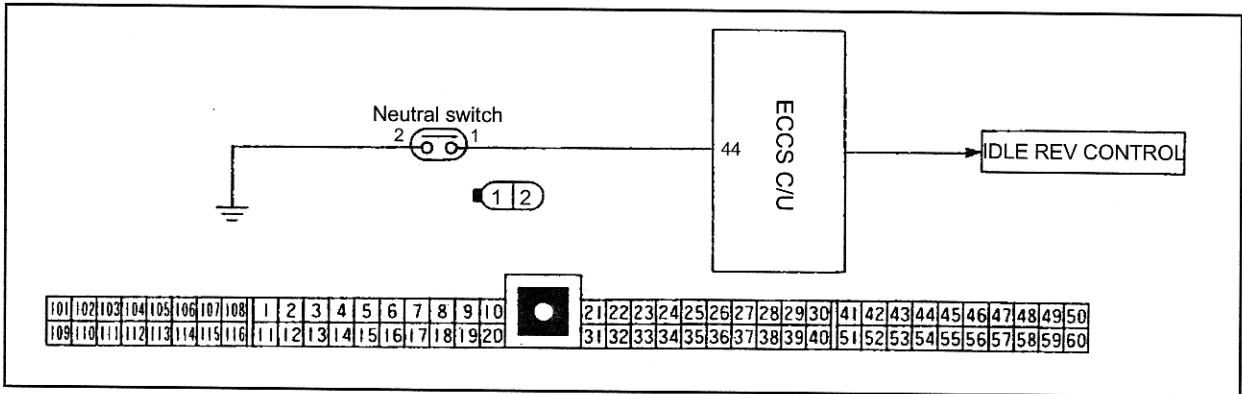

A

Function inspection

- Carry out "neutral sw" in function test mode. OR
- Carry out "neutral sw" in data monitor mode.

When neutral: ON
 Other: ON

- Place shift lever in neutral.
- Place ignition sw in the ON position.
- Check the power voltage between ECCS C/U connector terminal 44 and the body earth.

When neutral: 0V
 Other: 4.5V

NG

A

◆ NEUTRAL SW ◆

PRESS START WHILE SHIFT LEVER IS IN ANY POSITION OTHER THAN N OR P.

PASS START

OK

B

Harness continuity inspection

- Disconnect ECCS C/U and neutral sw connector and check continuity between ECCS C/U terminal 44 and neutral sw terminal 1.

Inspect ECCS C/U terminal for any damage or ECCS C/U connectors connection.

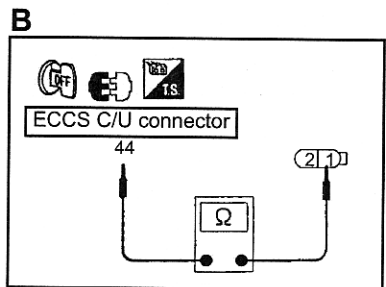
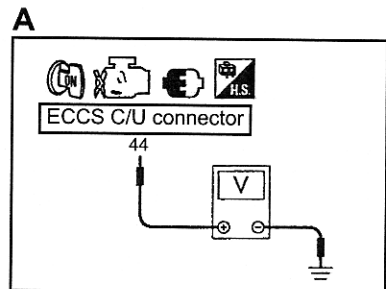

**14. AIR CONDITIONER OPERATION SIGNAL
CONTROL CIRCUIT DIAGRAM RB26DETT ENGINE**

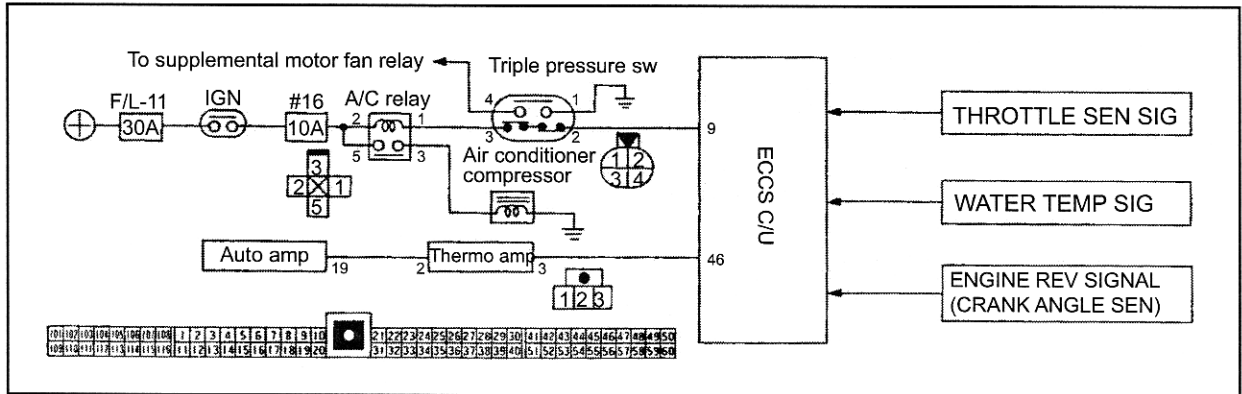

A

A/C sw input signal inspection

- Place ignition sw in the ON position.
- Check air conditioner signal using "air con signal" in data monitor mode.

Air conditioner sw ON: ON
Air conditioner sw OFF: OFF

- Check the power voltage between ECCS C/U connector terminal 46 and the body earth.

Air conditioner sw ON: 0V
Air conditioner sw OFF: Power voltage

OK Finish

A

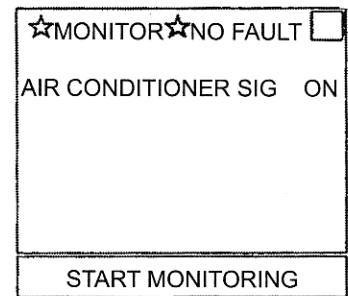

B

Harness continuity inspection

- Place ignition sw in the OFF position.
- Disconnect ECCS C/U and thermo amp connectors.
- Check for harness continuity between ECCS C/U connector terminal 46 and thermo amp terminal 3.

NG

Faulty harness or connector.

OK

Inspect each connector terminal for damage and check connector contacts.

A

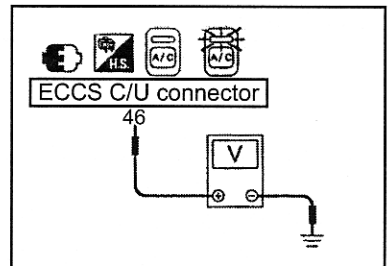

B

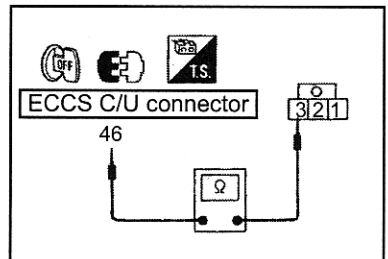

15. AIR REGULATOR SYSTEM
CONTROL CIRCUIT DIAGRAM RB26DETT ENGINE

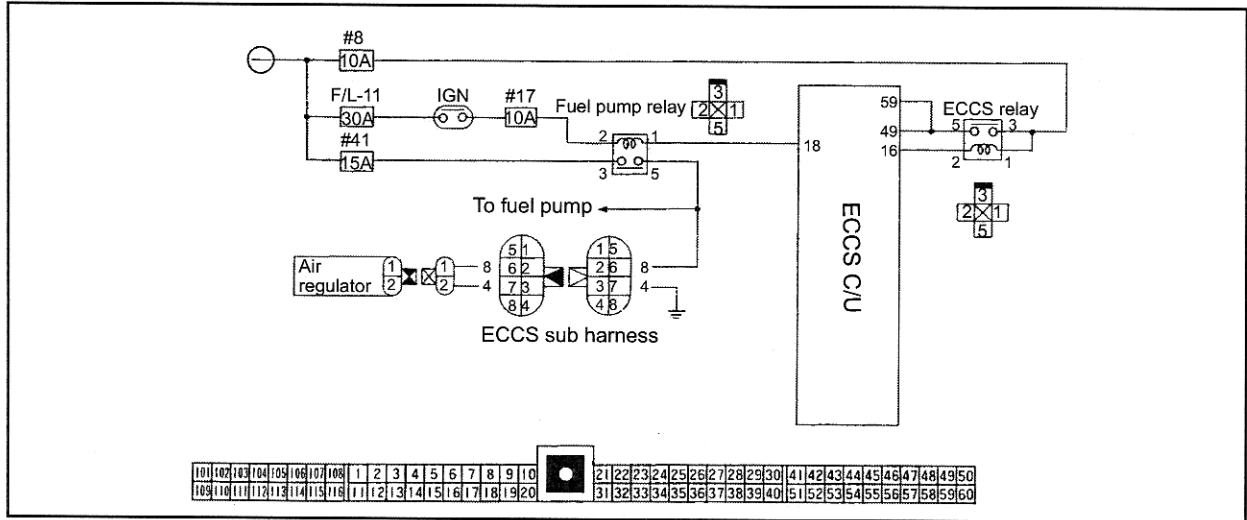

A

Function inspection

- Carry out "fuel pump" in function test mode.
- Place ignition sw in the ON position.
- Check fuel pump operation noise.

The fuel pump will operate for approx. 5 seconds after ignition sw is placed in the ON position.

NG

A

◆ FUEL PUMP ◆

IS THERE FUEL PULSATION EVERY 3 SECONDS WHEN THE FUEL TUBE IS HELD? OR CAN YOU HEAR THE FUEL PUMP RELAY OPERATION NOISE?

PASS NO YES

OK

Check fuel pump operation.

B

Power inspection

- Place ignition sw to OFF position.
- Remove ECCS sub harness connector.
- Check power voltage between ECCS sub harness connector terminal 8 and body earth.

NG

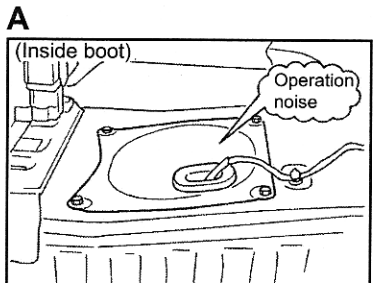

OK

Check the following:
 Continuity between ECCS sub harness and fuel pump relay.
 If NG check harness or connector.

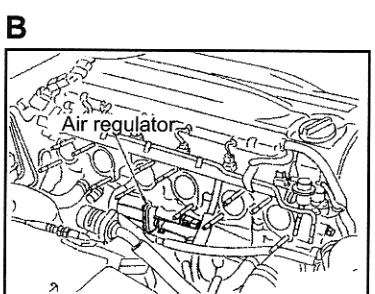

C

Earth circuit inspection

- Place ignition sw to OFF position.
- Check continuity between ECCS sub harness connector terminal 4 and body earth.

NG

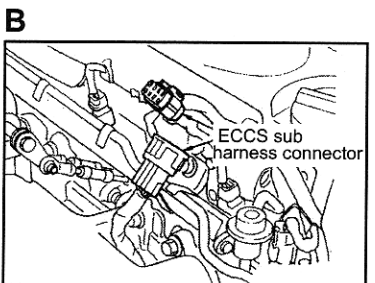

OK

Faulty harness or connector.

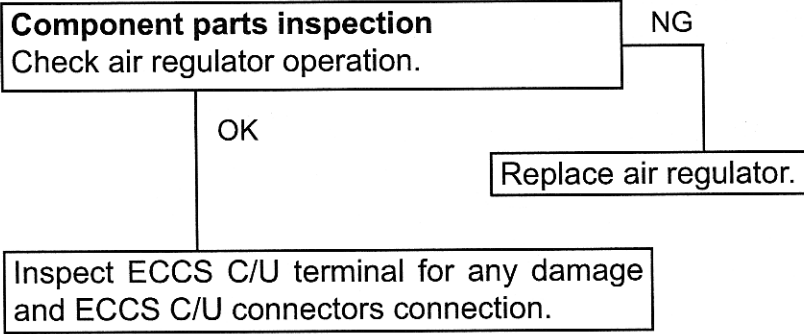

B

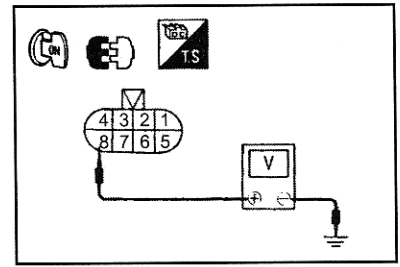

B

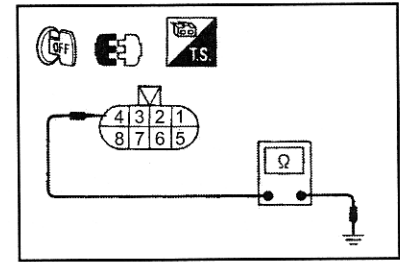

16. SUPPLEMENTAL MOTOR FAN CONTROL
CONTROL CIRCUIT DIAGRAM RB26DETT ENGINE

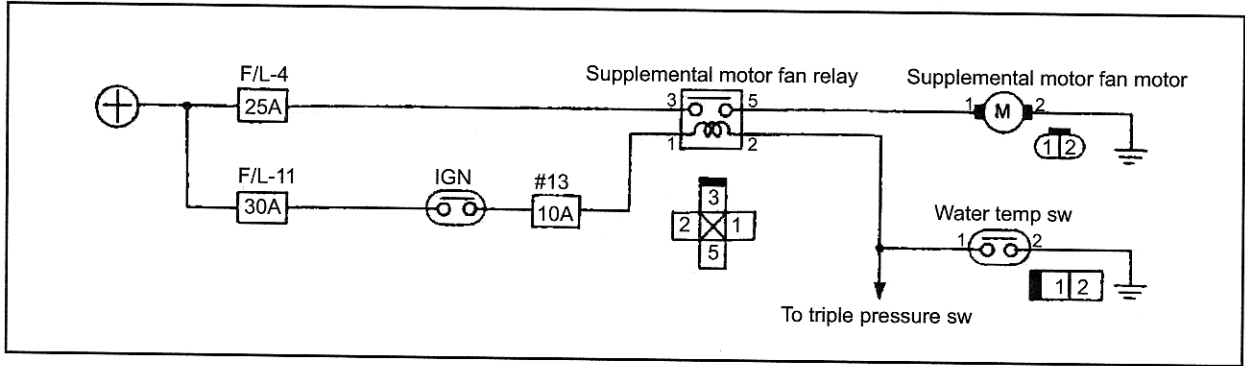

A
Function inspection

- Place ignition sw in the OFF position.
- Remove water temperature sw harness connector.
- Short circuit water temperature sw harness connector terminal 1 ~ 2.
- Place ignition sw in the ON position. Make sure the radiator fan will operate.

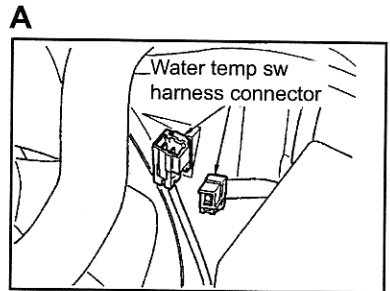

OK
 Check water temperature sw.

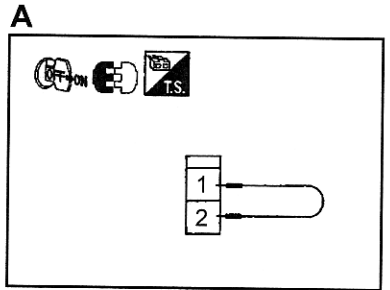

B
Power inspection

- Place ignition sw in the OFF position.
- Remove fan relay.
- Place ignition sw in the ON position.
- Check power voltage between fan relay box side terminal 1 & 3 and body earth.

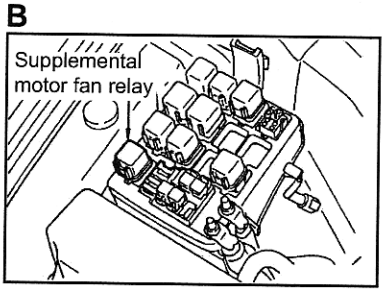

OK
 Check the following:
 #13 10A fuse
 25A fusible link
 Harness and connector
 If NG replace or repair parts.

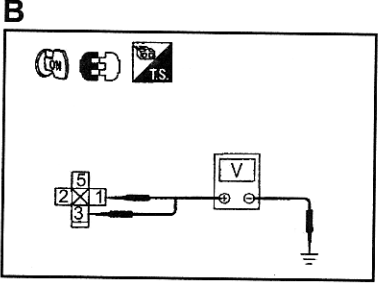

C
Earth circuit inspection

- Place ignition sw in the OFF position.
- Remove supplemental motor fan motor harness connector.
- Check for continuity between fan motor terminal 2 & water temperature sw terminal 2 and body earth.

OK
 To D

NG
 Faulty harness or connector.

D

Control signal circuit inspection

- Check for continuity between fan relay terminal 5 and fan motor terminal 1.
- Check for continuity between fan relay terminal 2 and water temperature sw terminal 1.

NG

OK

Faulty harness or connector.

Component parts inspection

Inspect supplemental motor fan relay, supplemental motor fan motor and water temperature sw.

NG

OK

Replace faulty parts.

Inspect ECCS C/U terminal for any damage and ECCS C/U connectors connection.

C

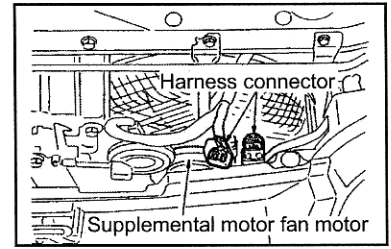

C

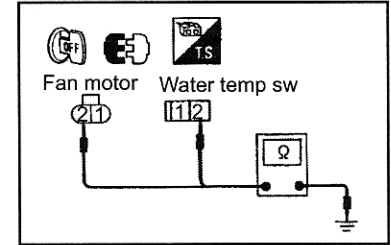

D

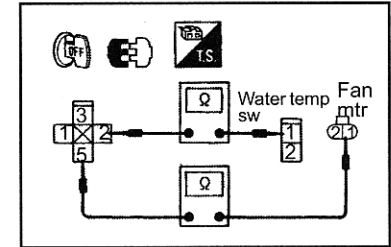

17. COMPONENT PARTS INSPECTION

1. Ignition coil

- Remove ignition coil harness connector.
- Check the resistance between following terminals:
Primary coil resistance (1~2) (Ω): Approx. 0
Secondary coil resistance (3~4) (Ω): ∞
- If NG replace ignition coil.

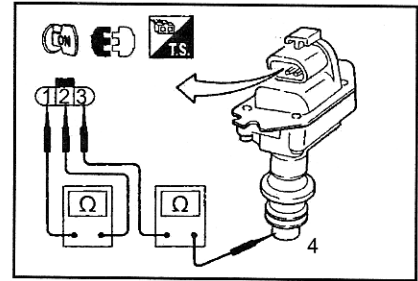

2. Ignition coil relay

- Directly apply battery voltage between terminal 1 ~ 2. Check for continuity between terminal 3 ~ 5.
When battery voltage is applied: Continuity present
When no battery voltage: No continuity
- If NG replace ignition coil relay.

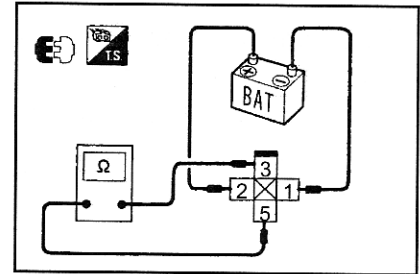

3. Throttle valve switch

- Warm up the engine.
- Remove throttle valve switch connector.
- Check for resistance between throttle valve switch terminal 2 ~ 1.
When accelerator pedal is not depressed (idle contact point ON) (Ω): 0
When accelerator pedal is depressed (idle contact point OFF) (Ω): ∞
- If NG replace and adjust the throttle valve switch.

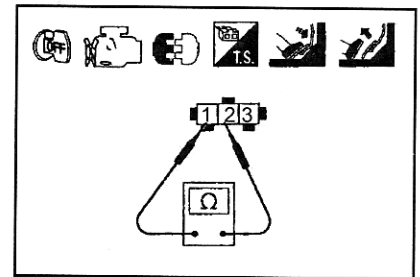

Throttle valve switch adjustment:

- Idle contact point touch speed (rpm): 1200+/-150
- If touch speed is not at above value, use the following steps to carry out adjustment:
- Remove AAC valve harness connector after engine warm up.
- Remove throttle valve switch connector and warm up the installation bolt.
- Lower engine speed by turning the throttle valve switch from "open" position until touch speed is at above value (no resistance 0 Ω between terminal 2~1). Tighten installation bolt.
- Install the throttle valve switch connector.
- Race the engine several times and make sure the idle rev is at correct value.

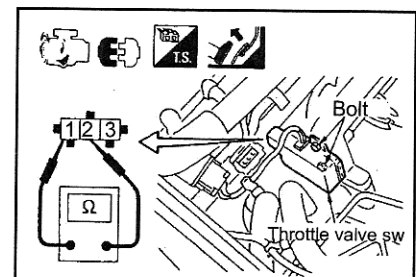

RB26DETT ENGINE

4. Injector

- Remove injector harness connector.
 - Check the resistance between terminal 1 ~ 2 for each cylinder.
- Resistance (Ω): Approx. 1.3
- If NG replace injector.

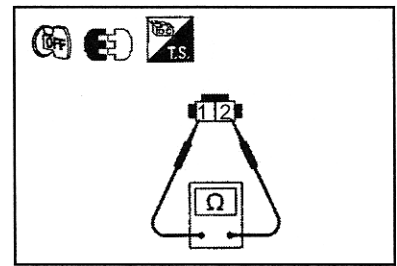

5. Dropping resistor

- Remove dropping resistor connector.
 - Check for resistance between dropping resistor terminal 3 ~ 1, 4, 5, 6, 7 & 8.
- Resistance (Ω): Approx. 4.2
- If NG replace dropping resistor.

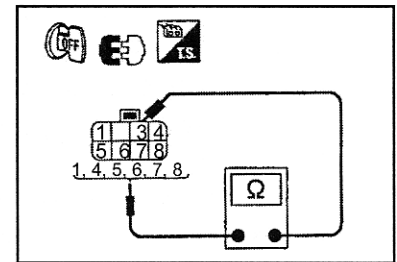

6. Fuel pump

- Remove fuel pump harness connector.
 - Check for resistance between fuel pump terminal 1 ~ 2.
- Resistance (Ω): Approx. 0.4 ~ 0.7
- If NG replace fuel pump.
 - Place terminal 1 to negative and terminal 2 to positive terminal to directly apply battery voltage and check for operation. Make sure the pump will operate.
 - If NG replace fuel pump.

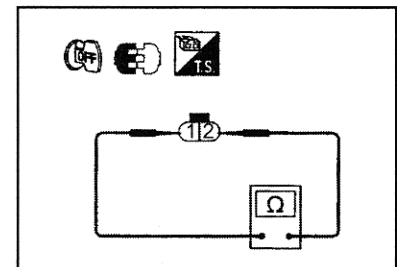

7. Fuel pump control modulator

- Remove the rear side inner panel inside the boot.
 - Check the power voltage between terminal 4 and 7 with FPCM connector still connected.
- Power voltage value:
- | | |
|---|-----|
| First 5 seconds after placing to ON position (V): | 6.4 |
| 5 seconds after placing to ON position (V): | 0 |
| Idling (V): | 6.4 |

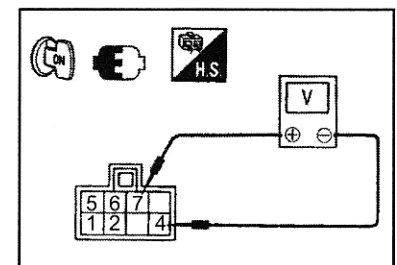
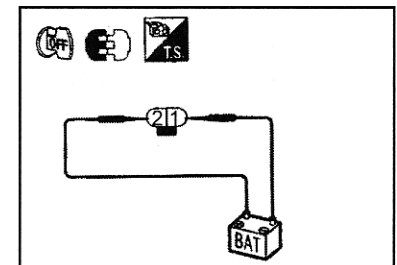

8. O₂ sensor heater

- Remove O₂ sensor harness connector.
 - Check the resistance between O₂ sensor terminal 1 ~ 3.
- Resistance (Ω): Approx. 2.6
- If NG replace O₂ sensor.

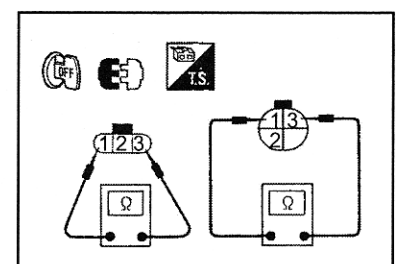

9. Air regulator

Static characteristic inspection

- Visually inspect the shutter opening degree.
Temperature range (°C)
Below -20°C: Fully open
20°C: Half open
Over 60°C: Fully closed

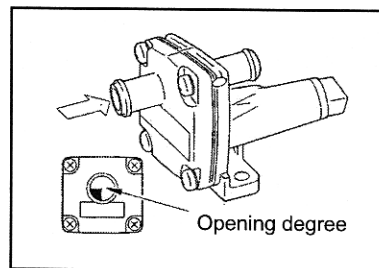

Dynamic characteristics inspection

- Check the change in shutter opening degree when the terminals are energized with battery. The shutter should open slowly within 7 minutes (surrounding area temperature at approx. 20°C).
(Reference)
Heater resistance value (Ω): Approx. 80 (at 20°C)
- If NG replace the air regulator.

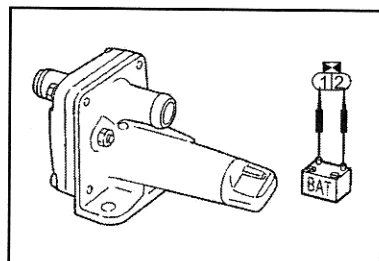

10. AAC valve

- Remove AAC valve harness connector.
- Check the resistance between AAC valve terminal 1 ~ 2.
Resistance (Ω): Approx. 7
- If NG replace AAC valve.
- Check the plunger and inspect switch.
- Inspect springs for any damage.

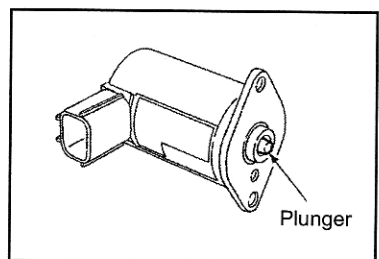
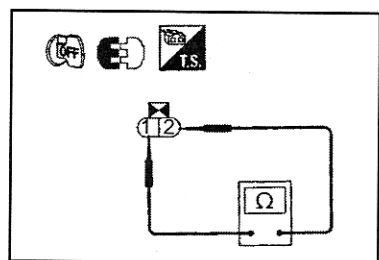

11. Boost control solenoid

- Remove boost control solenoid connector.
- Check the resistance between solenoid terminal 1 and 2.
Resistance (Ω): Approx. 32
- If NG replace boost control solenoid.

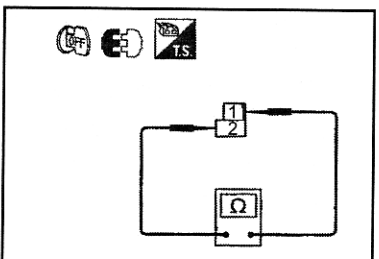

12. Supplementary power fan motor

- Remove supplementary power fan motor connector.
- Check if the fan motor will turn when the battery power is applied directly to terminal 1 ~ 2.
- If NG replace the supplementary power fan motor.

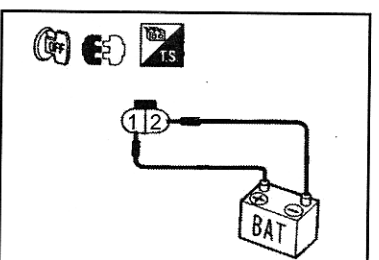

RB26DETT ENGINE

13. Power steering oil pressure switch

- Remove power steering oil pressure switch connector.
- Check for continuity between power steering oil pressure switch terminal 1 ~ 2.
 When neutral: No continuity
 When steered: Continuity present
- If NG replace power steering oil pressure switch.

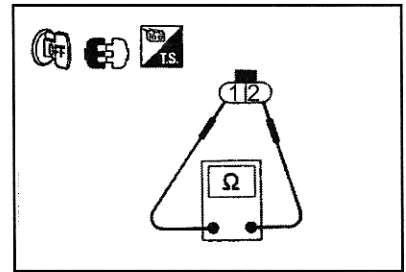

14. Supplementary motor fan relay & fuel pump relay

- Check for continuity between terminal 3 ~ 5 when battery voltage is directly applied to terminal 1 ~ 2.
 Battery voltage is applied to terminal 1 ~ 2: Continuity present
 No battery voltage is applied: No continuity
- If NG replace relay.

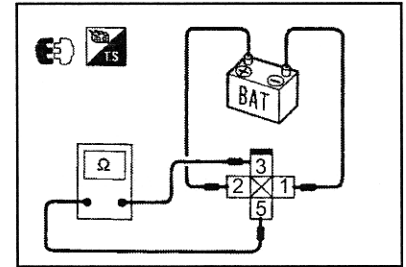

15. Water temperature switch

- Heat up the water temperature switch in hot water while stirring.
- Check for continuity between terminal 1 ~ 2.
 Water temperature below 90°C: No continuity
 Water temperature above 90°C: Continuity present

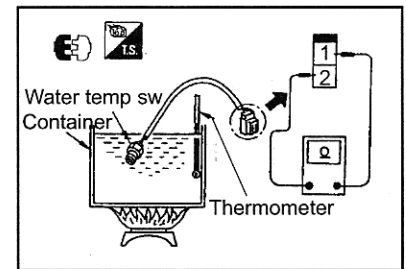

EN9 SYSTEM DIAGNOSIS INSPECTION (RB20E)

1. FUEL PUMP SYSTEM

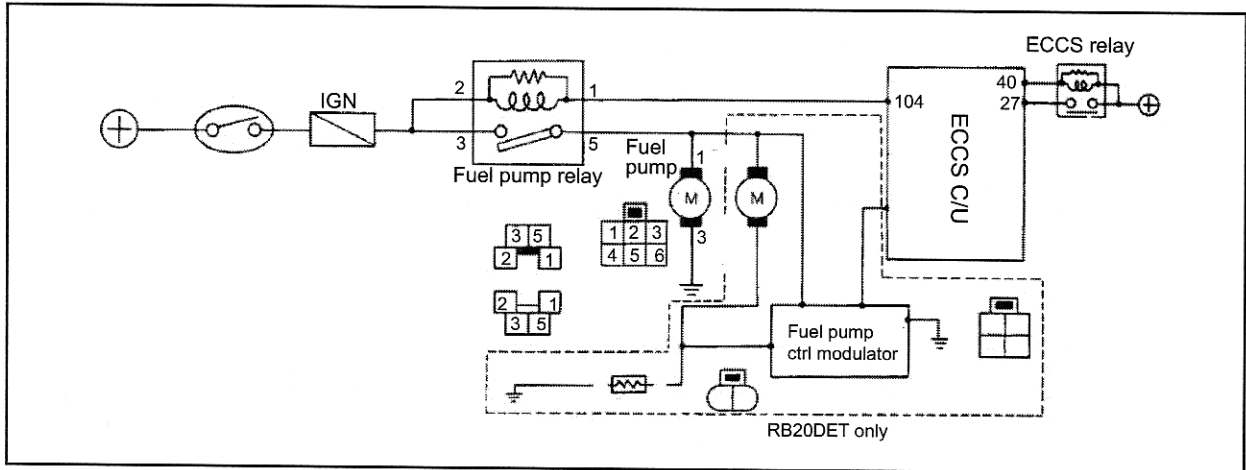

Fuel pump system trouble diagnosis flowchart RB20E ENGINE

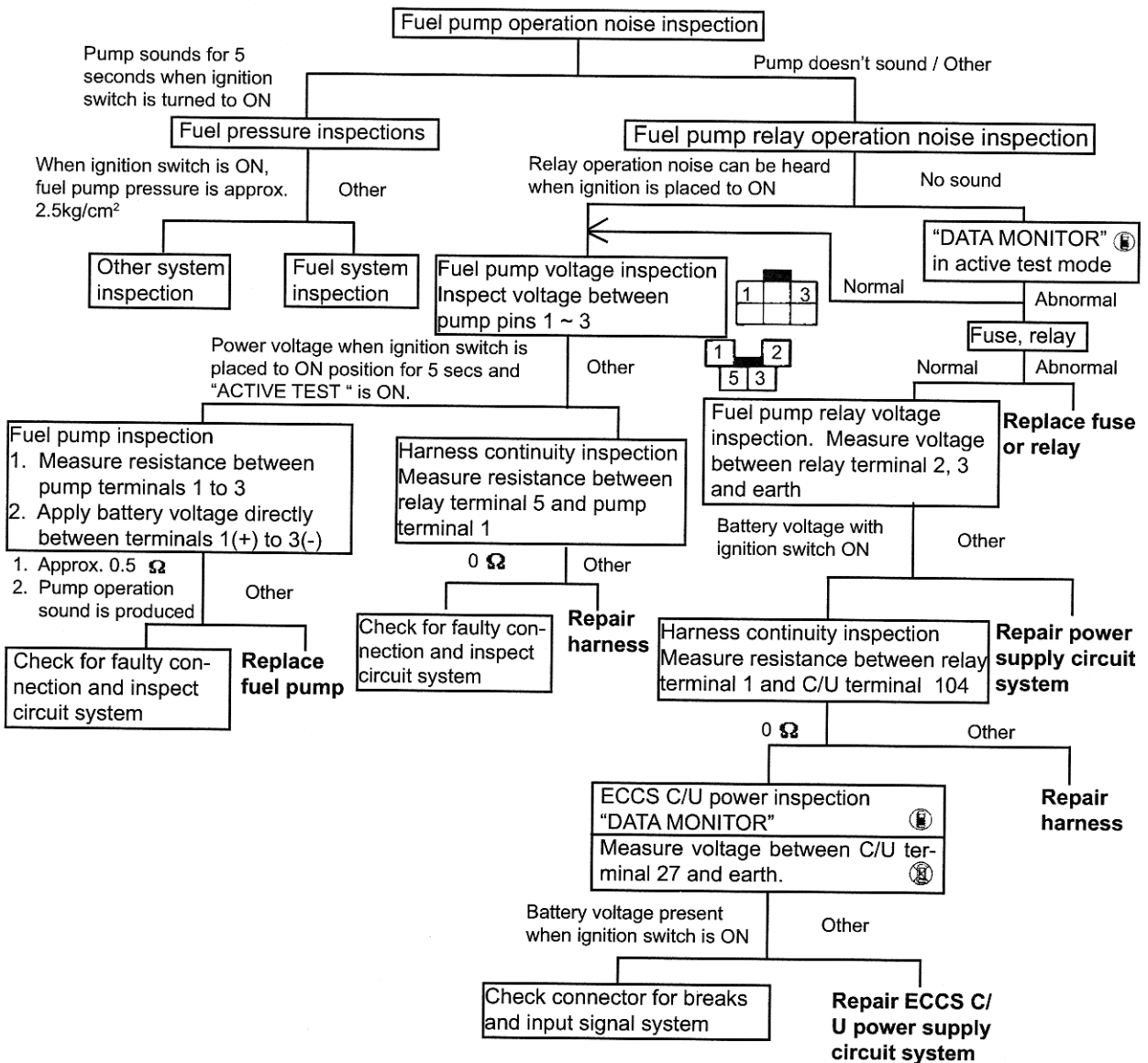

1 Fuel pump relay operation inspection

- Place the ignition switch in the ON position and select "FUEL PUMP RELAY" in active test mode. Press the ON button and check for pump operation noise.

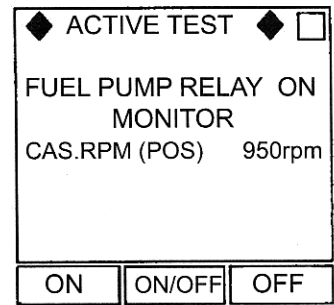

- When the ignition switch is in the ON position, the relay operation noise must be audible. There must be a relay cut off noise 5 seconds later.
- After engine stall, turn the ignition switch to OFF position 1.5 seconds later.

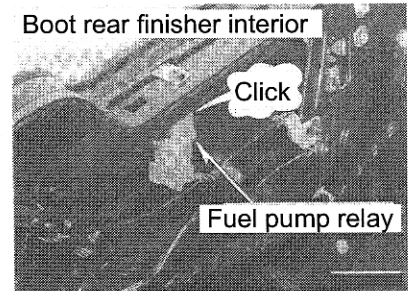

2 Fuel pump relay power inspection

- Disconnect the fuel pump relay and measure voltage between the following terminals and earth when the ignition switch is placed in the ON position.
Terminal 2 and body earth: Power voltage
Terminal 3 and body earth: Power voltage

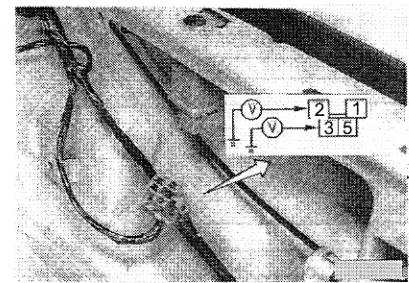

3 Fuel pump control signal inspection

- Select "FUEL PUMP RELAY" in data monitor mode and check the condition of the fuel pump relay
- | | |
|--------------------|-----|
| Ignition sw in ON: | OFF |
| Cranking: | ON |
| Idling: | ON |

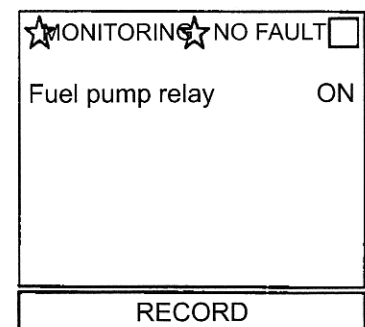

- Measure the voltage between terminal 104 and earth when the ECCS control unit connectors are connected.
Within 5 seconds after ignition sw is placed to in the ON position: Approx. 1V
5 seconds after ignition sw is turned to in the ON position: Power voltage
Cranking: Approx. 0V
Idling: Approx. 1V

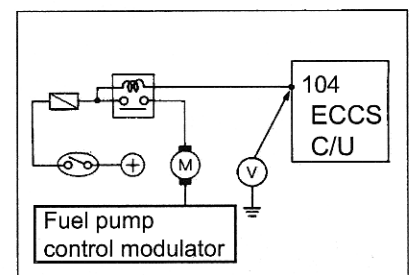



4 ECCS control unit power supply inspection

- Select "BATTERY VOLTAGE" in data monitor mode and carry out the inspection. 
- Ignition sw in the ON position: 11 ~ 14V

Note:

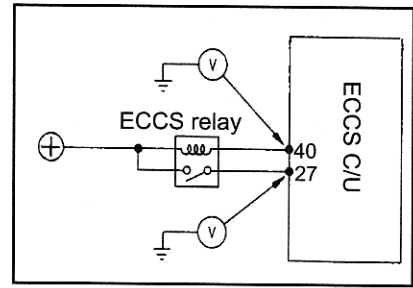
The same setting as ON position is maintained for a few seconds after the ignition switch is turned from ON to OFF and then ON position again.



- Measure the voltage between ECCS C/U terminal 27 and the earth when the ECCS control unit connectors are connected. 
- Ignition sw in OFF position: 0V
- Ignition sw in ON position: Power voltage
- Cranking: Power voltage
- Idling: Power voltage

5 Harness continuity inspection

- Disconnect ECCS control unit, fuel pump relay and fuel pump harness connectors and measure resistance between the following terminals.
ECCS C/U harness terminal 104 and fuel pump relay harness terminal 1: 0Ω
ECCS C/U harness terminal 1 and fuel pump relay harness terminal 5: 0Ω

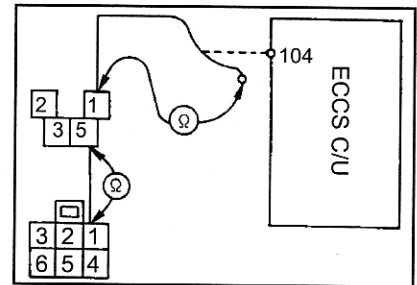

6 Fuel pump voltage inspection

- Disconnect the fuel pump connector and measure the voltage between the fuel pump harness terminal 2 and earth.
5 sec after ignition sw is turned to ON position: Power voltage
Cranking: Power voltage

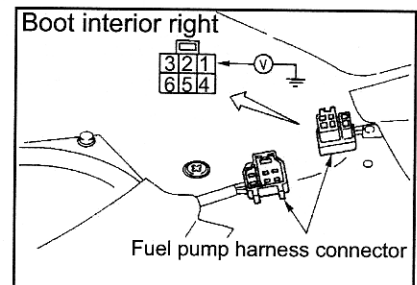

7 Fuel pump inspection

- Remove the fuel pump connector and check the resistance between fuel pump terminal 1 and 3.
Resistance (Ω): Approx. 0.4 ~ 0.
- Check the fuel pump operation by disconnecting the fuel pump connectors and apply power voltage directly to the following fuel pump terminals.
Pump terminal 1 to battery positive terminal (+).
Pump terminal 3 to battery negative terminal (-).

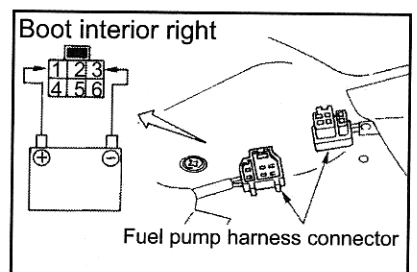
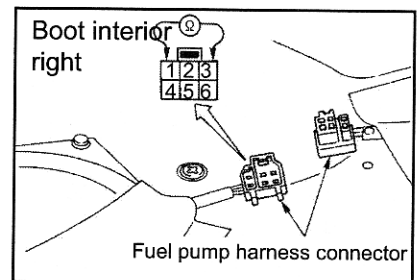

2. INJECTOR SYSTEM

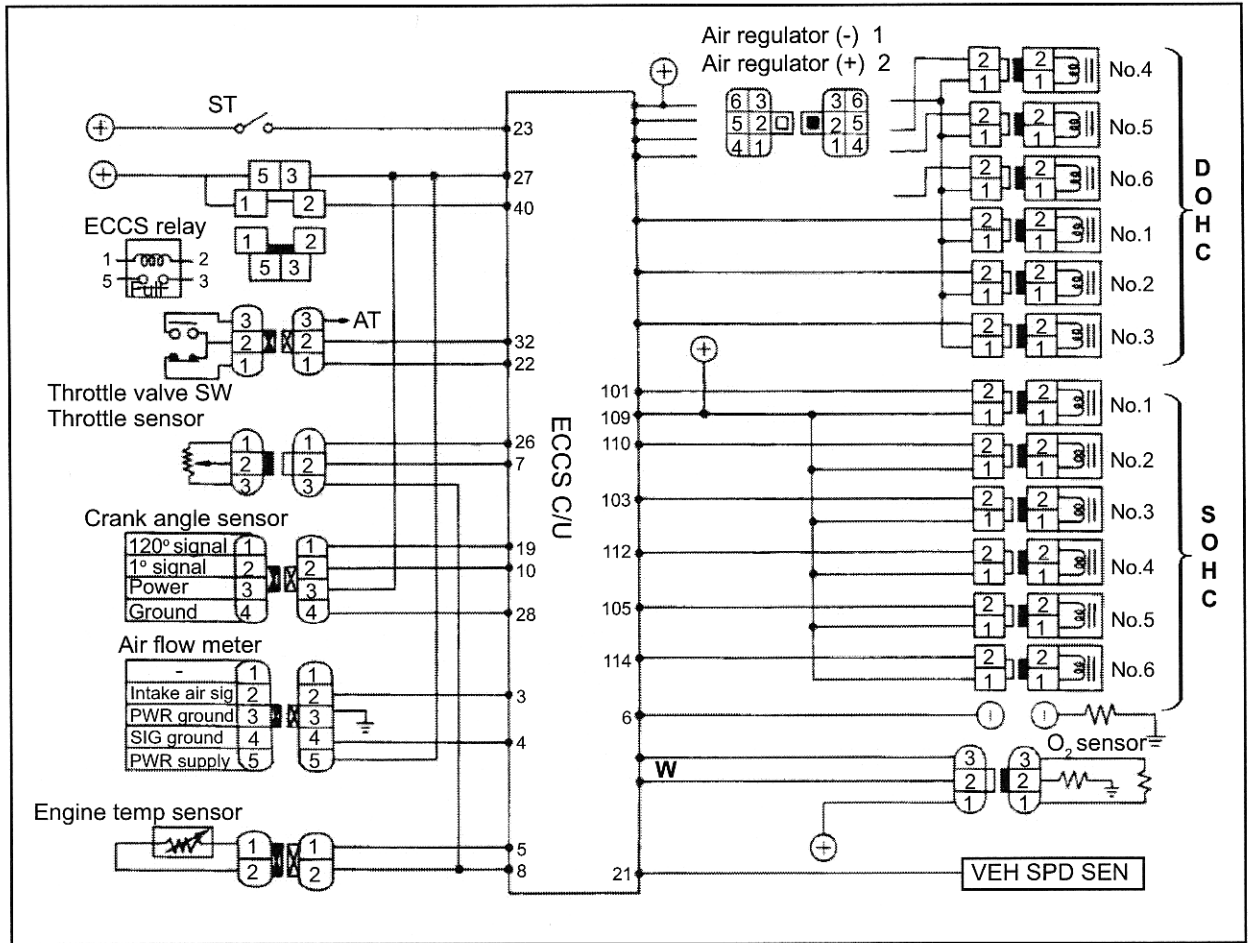

Injector system trouble diagnosis flowchart RB20E ENGINE

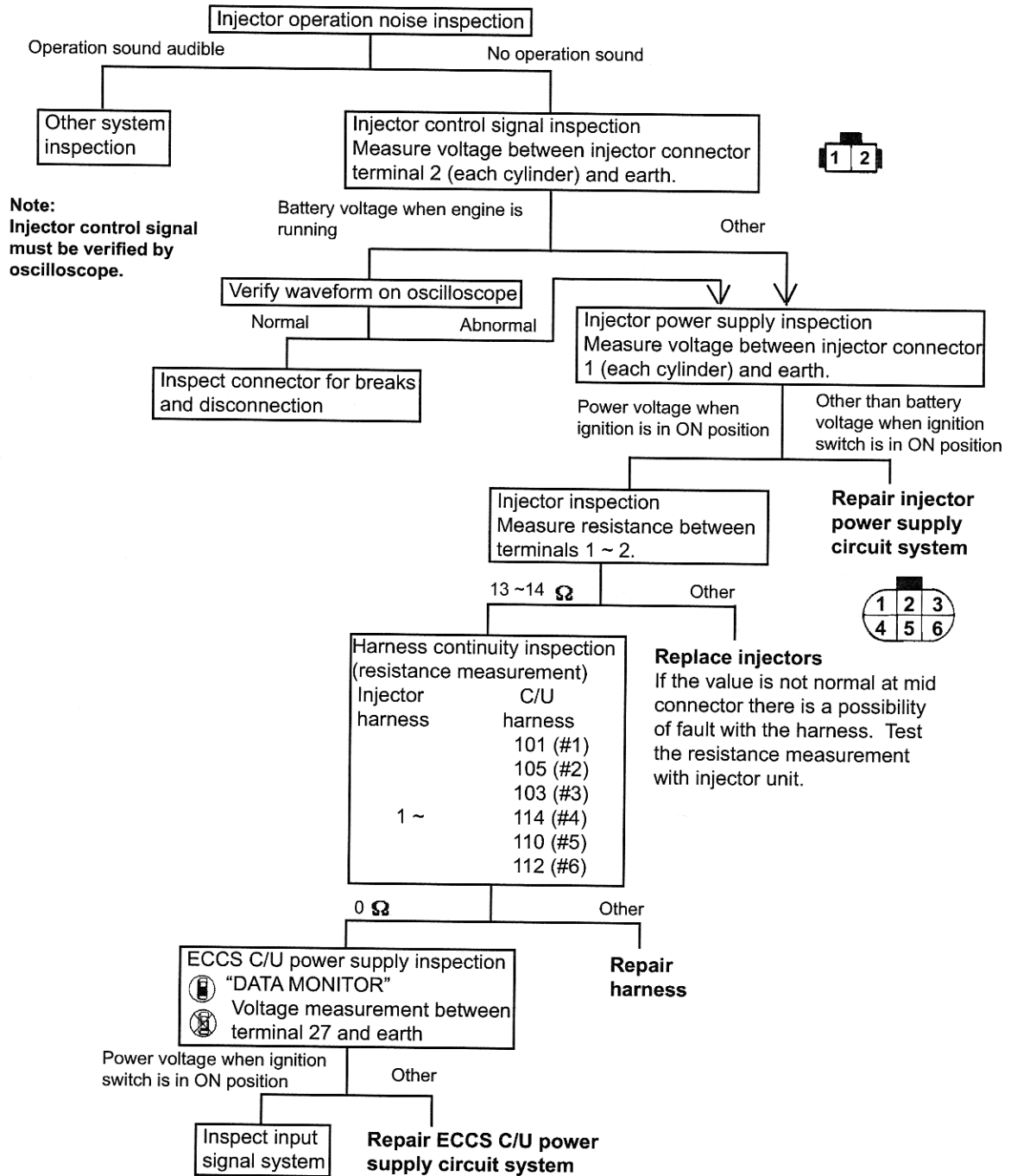

RB20E ENGINE

- Use "POWER BALANCE" in the CONSULT active test mode to check the idle speed variation and the injector operation. 

Caution:

Do not perform test while driving.

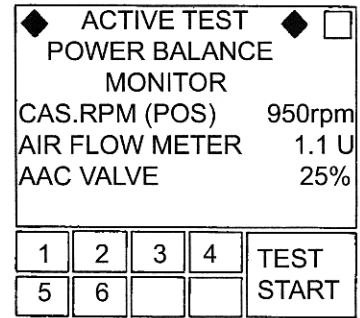

1 Injector control signal and power inspection 

[Injector connector]

- Disconnect the injector connectors and measure power voltage between harness terminal 2 and earth.
 Ignition sw in ON position: Power voltage
 Cranking: Approx. 10V

[ECCS Control unit connectors]

- Control circuit: Measure power voltage between ECCS C/U terminals 101, 103, 105, 110, 112, 114 and earth.
 Ignition sw in ON position: Power voltage
 Cranking: Approx. 10V
- Power supply circuit: Measure power voltage between ECCS C/U terminal 109 and earth.
 Ignition sw in ON position: Power voltage
 Cranking: Approx. 10V

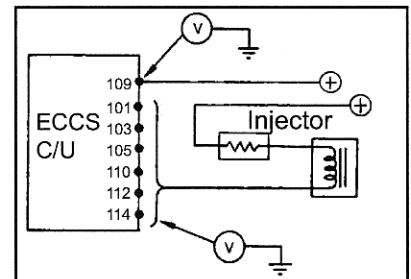

2 Harness continuity inspection

- Disconnect control unit and injector connectors and measure the resistance between following terminals:

ECCS C/U harness	Injector harness terminal 2
101	No. 1 cylinder
110	No. 2 cylinder
103	No. 3 cylinder
112	No. 4 cylinder
105	No. 5 cylinder
114	No. 6 cylinder

Resistance between terminals: 0Ω

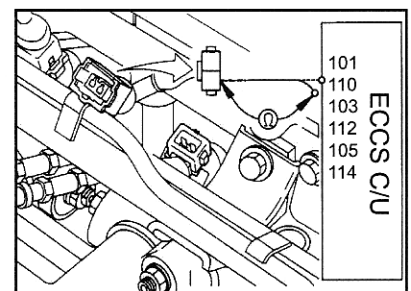

3. Injector inspection

- Remove injector connector and measure the resistance between the terminals for each injector.
 Between injector terminal 1 and 2 for each cylinders:
 13 ~ 14Ω

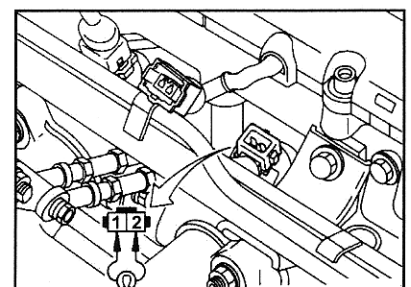

RB20E ENGINE

3. IGNITION SYSTEM

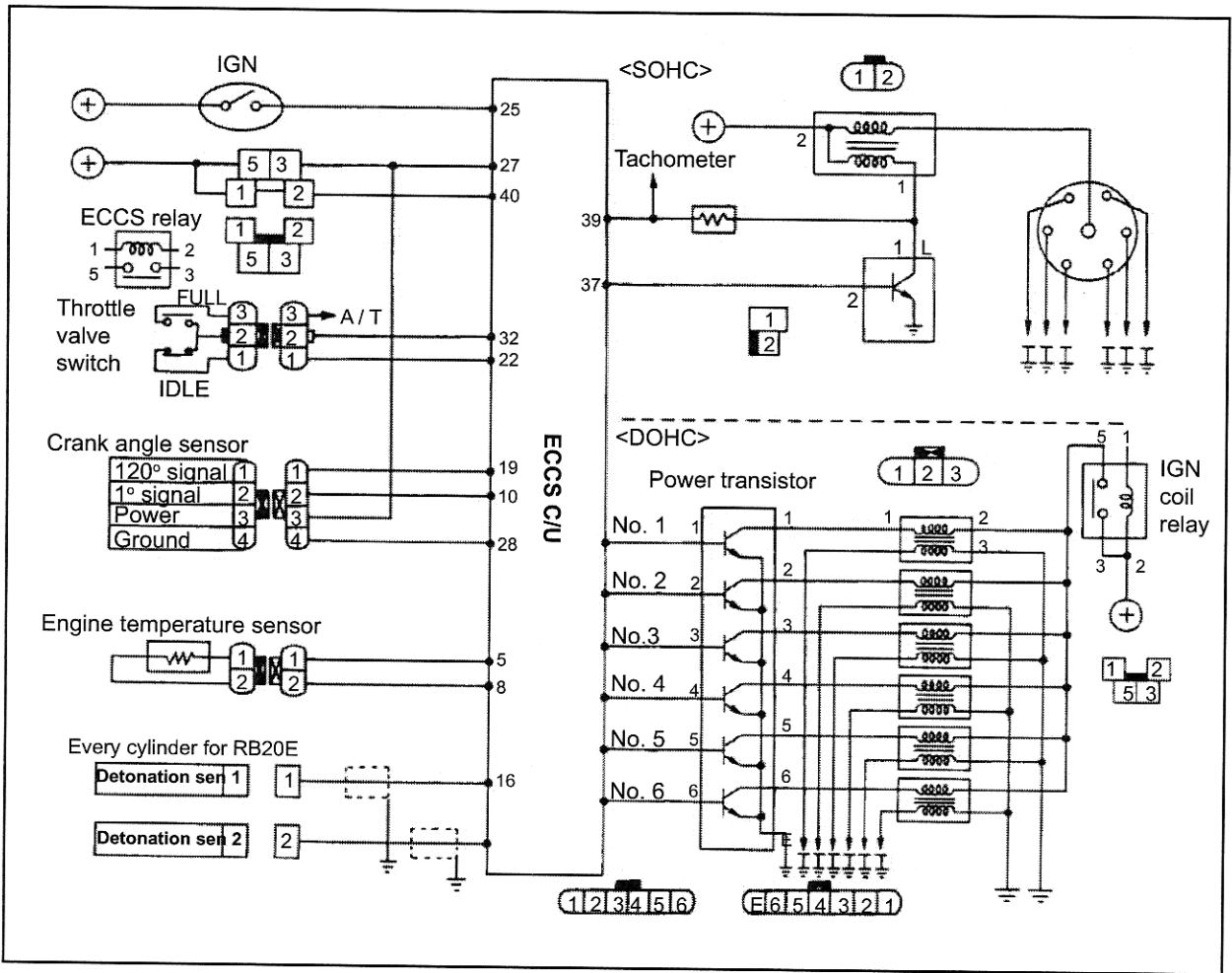

RB20E ENGINE

1 Self-diagnosis

- Check faulty system in "SELF-DIAGNOSTIC RESULT" mode when the ignition switch is placed in the ON position and engine cranking.
- When there is abnormal output, inspect assumed locations in the following sequence.

Power transistor (short) - ECCS harness (short) - ECCS control unit

- Place ignition switch in the ON position.
- Perform diagnosis mode selection procedure with the diagnosis connector in the vehicle. Check the code number of the faulty system displayed by the flashing exhaust gas temperature warning lamp on the instrument panel.

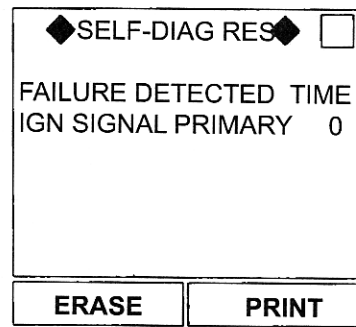

2 Power transistor control signal inspection

- Measure the power voltage between ECCS C/U terminal 37 and the earth when the ECCS control unit connectors are connected.

Cranking:	0.2 ~ 0.3V
Idling:	0.2 ~ 0.3V
At 2,500 rpm:	Approx. 1.0V

3 Ignition primary voltage signal inspection

- Measure the power voltage between ECCS C/U terminal 39 and earth with ECCS control unit connector connected.

Cranking:	5 ~ 10V
Idling:	Power voltage
At 2,500 rpm:	Lower than power voltage

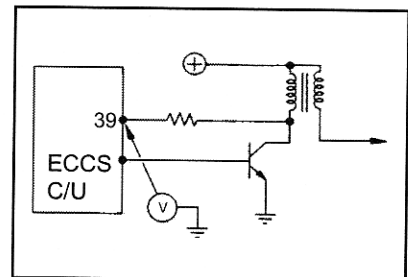

4 Harness continuity inspection

- Disconnect ECCS control unit and power transistor connector and measure the resistance between ECCS C/U harness terminal 37 and the power transistor terminal 2.

Resistance (Ω): 0

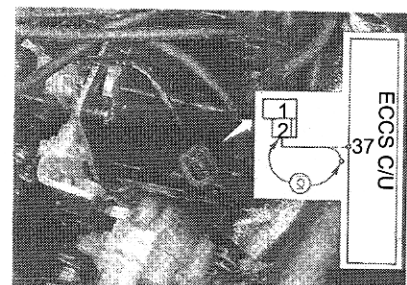

5 Power transistor inspection

- Check the resistance between all power transistor terminals using an analog circuit tester probe by changing the positive and negative poles.

Inspection terminals and values	
1 ~ 3	+/- 0 or not $\infty\Omega < +/- \infty\Omega$
2 ~ 3	+/- or not $\infty\Omega = +/- 0$ or not $\infty\Omega$
1 ~ 2	+/- 0 or not $\infty\Omega < +/- \infty\Omega$

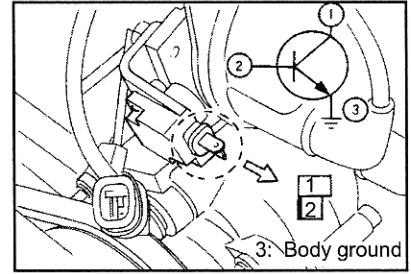

6 Ignition coil inspection

- Measure the primary coil resistance value.
 Primary coil resistance value (1 ~ 2): 0.8 ~ 1.2
 Secondary coil resistance value (1 ~ 3): 7 ~ 12

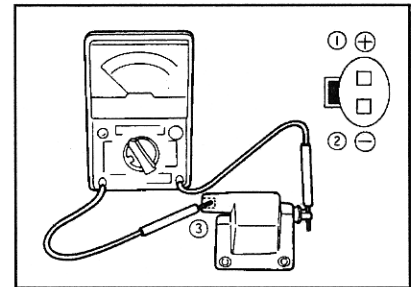

7 High tension cable resistance value

- Measure the resistance of high tension cables.
 No. 1 cylinder: 5 ~ 12K Ω
 No. 2 cylinder: 6 ~ 15K Ω
 No. 3 cylinder: 8 ~ 18K Ω
 No. 4 cylinder: 8 ~ 18K Ω
 No. 5 cylinder: 8 ~ 19K Ω
 No. 6 cylinder: 8 ~ 19K Ω
 Centre cable: 4 ~ 10K Ω

4. IDLE SPEED CONTROL SYSTEM

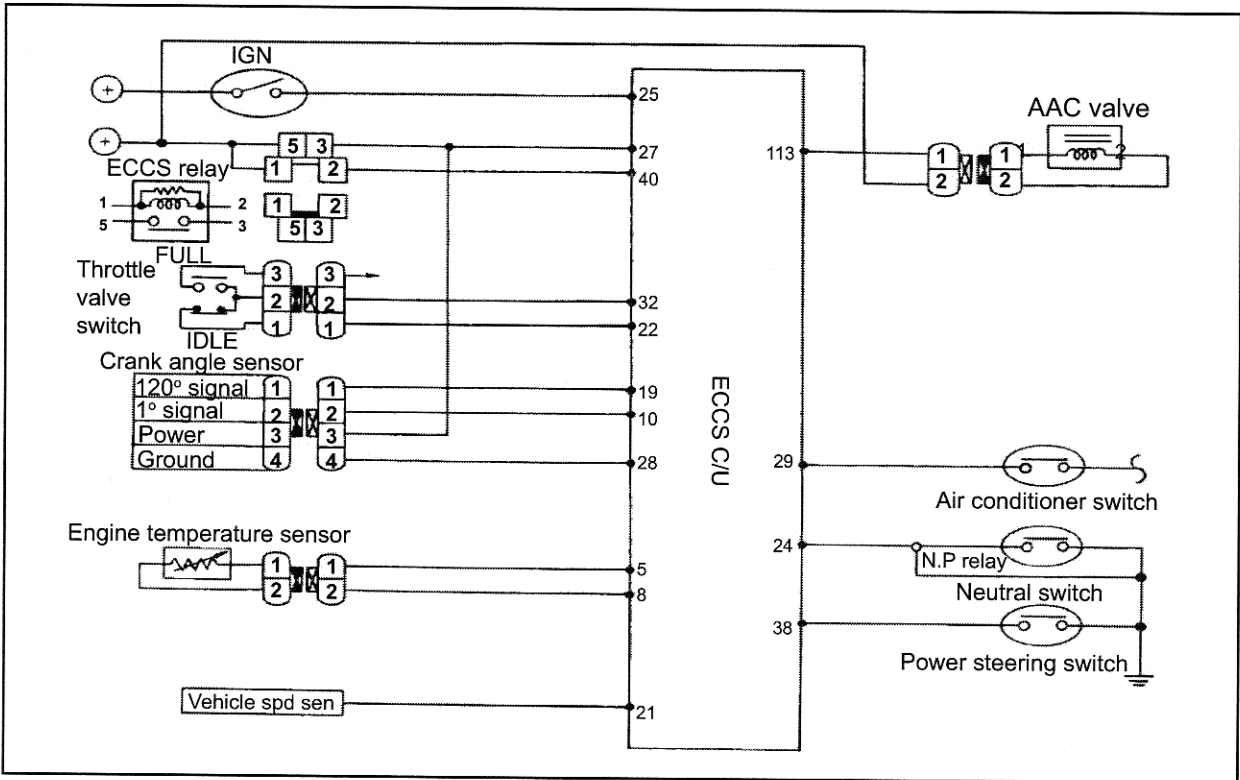

Idle speed control system trouble diagnosis flowchart RB20E ENGINE

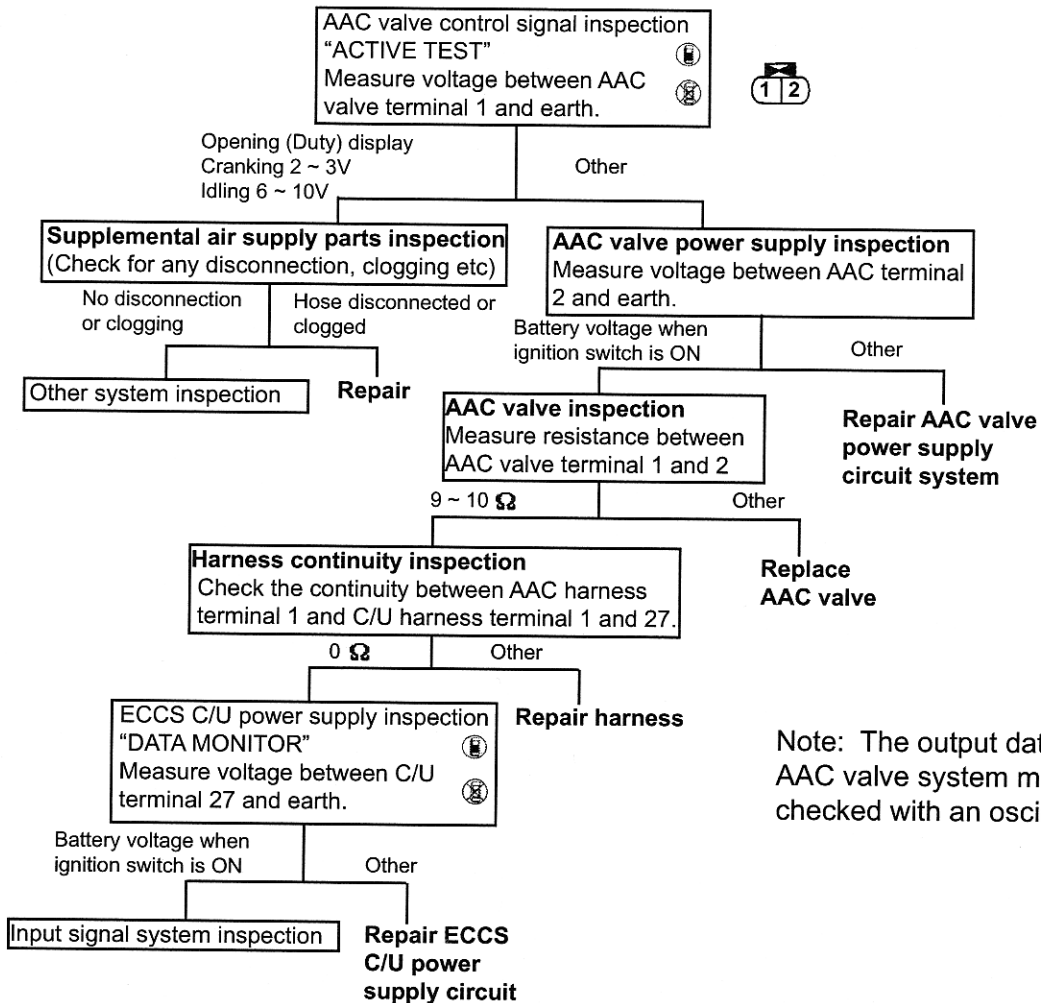

Note: The output data for the AAC valve system must be checked with an oscilloscope.

RB20E ENGINE

1 AAC valve control signal inspection

- Measure the voltage between ECCS C/U terminal 113 and earth when the ECCS control unit connector is connected.

Ignition sw in ON position: Power voltage
 Cranking: 2 ~ 3 V
 Idling (when cold): 6 ~ 7 V
 Idling (after warm-up): 8 ~ 10 V

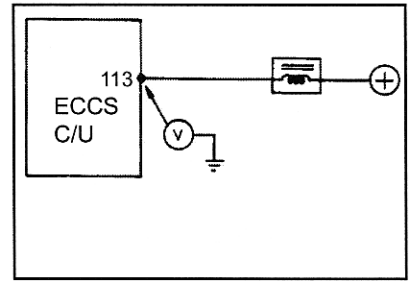

- Measure voltage between the AAC valve connector terminal 1 and earth.

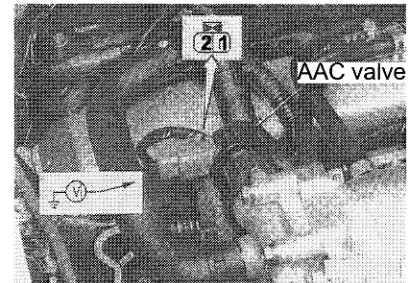

2 AAC valve system inspection



- Use "AAC VALVE OPENING" item in active test mode to set an optional angle.
- Check that idle speed changes according to setting value at this time.

◆ ACTIVE TEST ◆	
AAC/V OPENING	27%
MONITOR	
CAS.RPM (POS)	950rpm
AIR FLOW MTR	0.93V
AIR FLOW MER-R	0.92V
ENG TEMP SEN	68°C
Qu	UP
DWN	Qd

3 AAC valve power supply inspection

- Disconnect AAC valve connector and measure power voltage between AAC valve connector harness terminal 2 and earth.

When ignition sw is in ON position: Power voltage

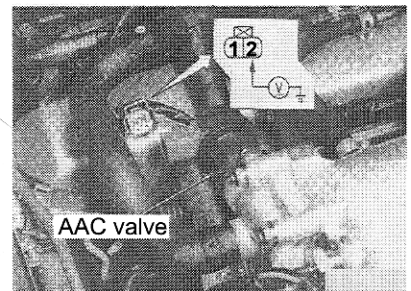

4 Harness continuity inspection

- Disconnect the connector from the ECCS control unit and AAC valve and measure the resistance between ECCS C/U harness terminal 113 and AAC valve harness terminal 1.

Resistance (Ω): 0

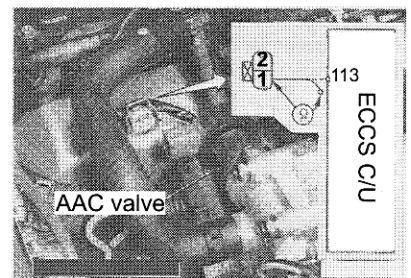

5 AAC valve inspection

- Disconnect the AAC valve connector and measure resistance between AAC valve terminal 1 and 2.

Resistance (Ω): 9 ~ 10

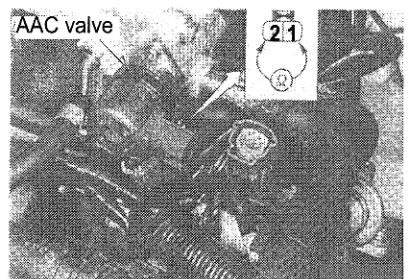

5. CRANK ANGLE SENSOR SYSTEM

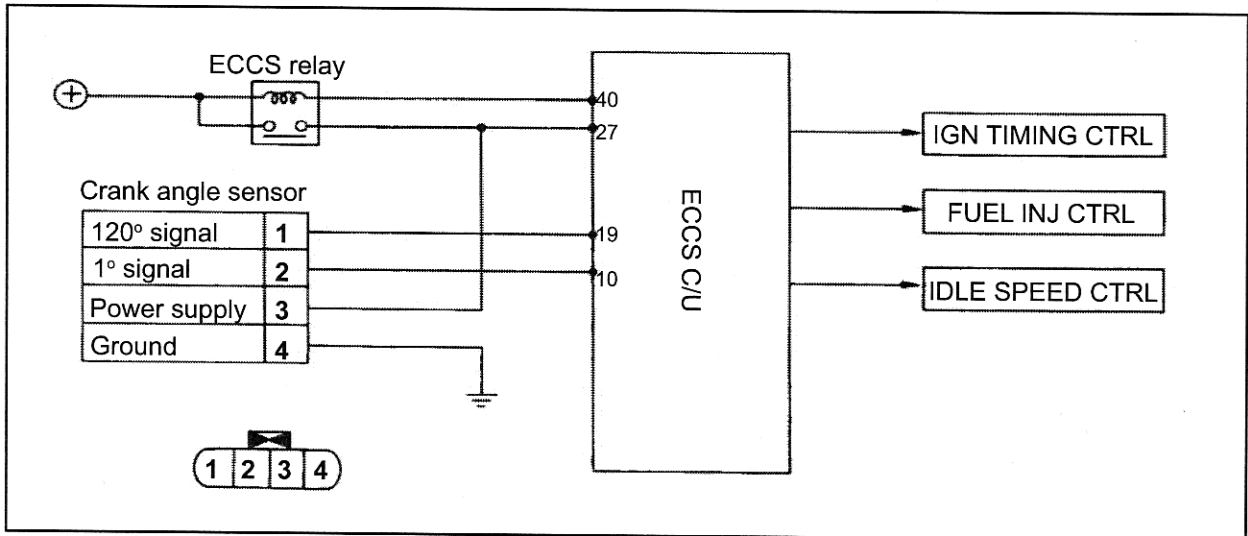

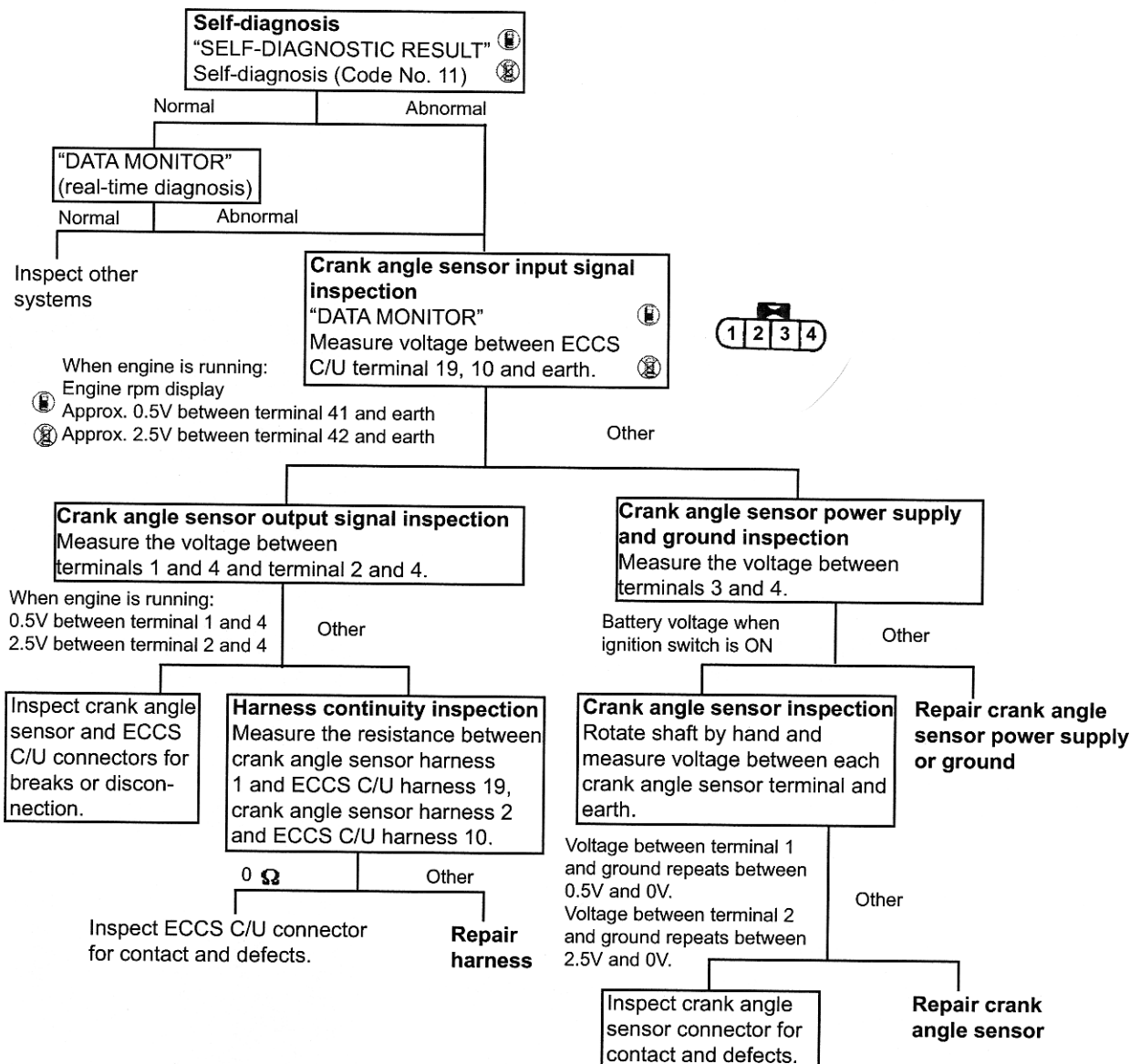

Crank angle sensor system trouble diagnosis flowchart RB20E ENGINE



1 Self-diagnosis

- If 1° or 120° signal is not input within fixed period of time, "CODE No. 11" or "FAULTY SYSTEM NAME" will be displayed in normal self-diagnosis operation when using CONSULT. Examine the following items carefully when this occurs.
- If a malfunction occurs again, use the  real-time diagnosis (CONSULT data monitor mode) or oscilloscope to detect disconnection.
- When an abnormality is detected, consider these locations in the following sequence as there may be other malfunctions besides the crank angle sensor.
ECCS harness (faulty contact) - Crank angle sensor - ECCS control unit

2 Input signal inspection

- Use "CAS.RPM (POS)" item in data monitor mode to determine engine speed. 
- Measure the voltage between ECCS C/U terminal 41 and earth (120° signal), between ECCS C/U terminal 42 and earth (1° signal). 

☆ MONITOR ☆ NO FAIL 
CAS.RPM (POS) 975rpm
AIR FLOW MTR 0.91V
AIR FLOW MTR (R) 0.92V
ENG TEMP SEN 78°C
EXH GAS SEN 1.22V
EXH GAS SEN (R) 0.02V
M/R R/C MNT RICH
M/R F/C MNT-R RICH
RECORD

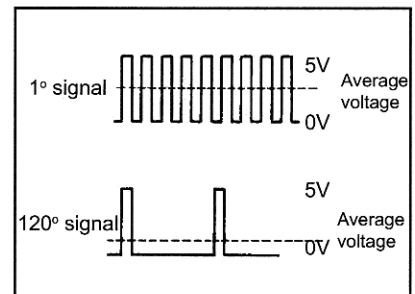
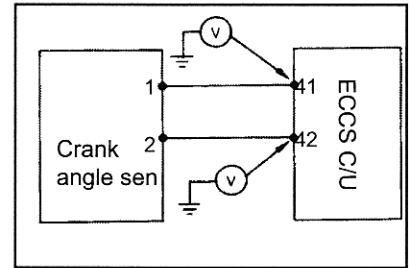

Note:

The power voltage value above are average voltage value of the pulse waveform measured by circuit tester and these are for reference only. The waveform must be checked using oscilloscope.

RB20E ENGINE

3 Sensor output signal inspection

- Measure the voltage between the following terminals:
 Crank angle sensor terminal 2 and earth (1° signal):
 Ignition sw in ON position: 0V or approx. 5
 Cranking: 2 ~ 3 V
 Idling: 2 ~ 3 V
 Crank angle sensor terminal 1 and earth (120° signal):
 Ignition sw in ON position: 0V or approx. 5
 Cranking: 0.5 V
 Idling: 0.3 ~ 0.7 V
 Crank angle sensor terminal 3 and ground (power):
 Ignition sw in ON position: Power voltage
 Cranking: Power voltage
 Idling: Power voltage

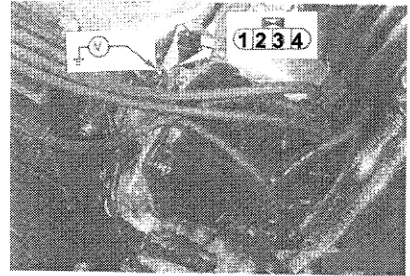

4 Harness continuity inspection

- Disconnect the ECCS C/U and the crank angle sensor connector and measure the resistance between ECCS C/U harness terminal 19 and crank angle sensor 1, ECCS C/U harness terminal 10 and crank angle sensor 2.
 Resistance (Ω): 0

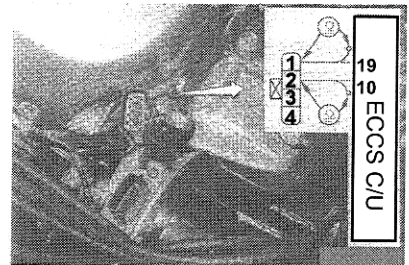

5 Crank angle sensor inspection

- Disconnect the crank angle sensor from the engine, turn the shaft by hand and measure the power voltage using connector.
 Crank angle sen 2 and earth (1° sig): 0V or 5V
 Crank angle sen 1 and earth (120° sig): 0V or 5V
 Crank angle sen 3 and earth (Battery voltage): Power voltage
 Crank angle sen 4 and earth : 0V

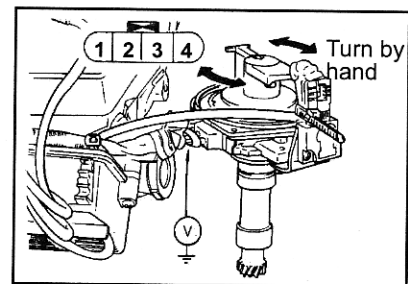

Caution:

To prevent injector from operating, remove fuse or connector before inspection. Abnormality may be detected by self-diagnosis mode if the shaft is not turned smoothly.

1 Self-diagnosis

- Normally in a self-diagnosis operation, "CODE No.12" or "FAULTY SYSTEM - AIR FLOW METER" (when using CONSULT) is displayed if the intake air quantity signal voltage is abnormally high or low and disconnection or short-circuit in the signal system should be considered.
- If a malfunction occurs again, use real-time diagnosis (CONSULT data monitor mode) or oscilloscope to detect instantaneous breaks. 
- When an abnormality is detected, consider these locations in the following sequence as there may be other malfunctions besides the air flow sensor.

When intake air quantity is low:

ECCS harness (faulty contact) - air flow meter -
ECCS control unit - intake system (not airtight)

When intake air quantity is high:

ECCS harness (faulty contact) - intake system (not airtight), faulty wastegate valve control - air flow meter - ECCS control unit

2 Input signal inspection

- Use "AIR FLOW METER" and "AIR FLOW METER (R)" in "DATA MONITOR" mode to check the following items. 

Ignition sw is in ON position:	Approx. 0.5V
Idling:	Approx. 1.1V
At 2,500 rpm:	Approx. 1.5~2V

☆ MONITOR ☆ NO FAULT <input type="checkbox"/>	
CAS.RPM (POS)	950rpm
AIR FLOW MTR	0.96V
AIR FLOW MTR (R)	0.87V

RECORD

- Measure power voltage between following terminals with ECCS control unit harness connected. 
ECCS C/U terminal 3 and earth (intake air quantity signal)

Ignition sw is in ON position:	Approx. 0.3V
Cranking:	Approx. 1V
Idling:	Approx. 1.1V
ECCS C/U terminal 4 and earth (earth signal)	
Ignition sw is in ON position:	Approx. 0V
Cranking:	Approx. 0V
Idling:	Approx. 0V

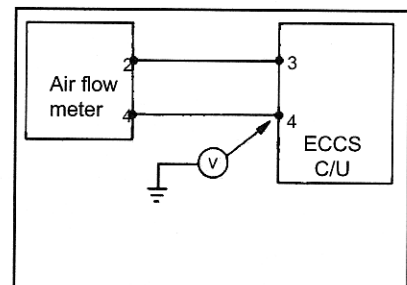

RB20E ENGINE

3 Air flow meter output signal inspection

- Measure the voltage between the following terminals when the air flow meter connectors are connected.

Air flow mtr terminal B and earth

Ignition sw is in ON position: Approx. 0.8V
 Cranking: Approx. 1V
 Idling: Approx. 1.1V

Air flow meter terminal E and earth

Ignition sw is in ON position: Approx. 0V
 Cranking: Approx. 0V
 Idling: Approx. 0V

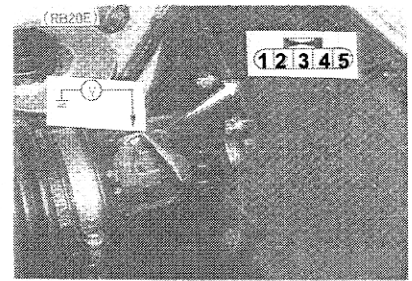

4 Air flow meter power supply inspection

- Measure the power voltage between the air flow meter terminal 5 and earth with the air flow meter connector connected.

Ignition sw in ON and engine running: Power voltage

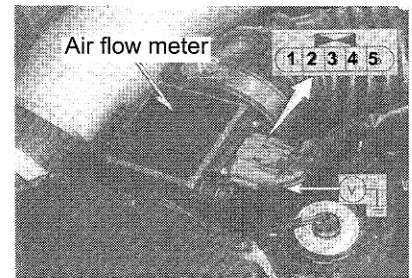

5 Harness continuity inspection

- Disconnect ECCS control unit and air flow meter connector and measure the resistance between following terminals.

Air flow meter harness	and	ECCS C/U harness
2		3
4		4
3		Body ground
5		ECCS relay harness 3
Resistance (Ω):		0

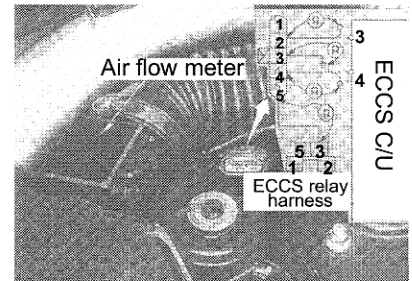

6 Air flow meter inspection

- Apply the battery voltage directly to terminal 5 (+) and 3 (-) and measure the voltage change between terminals 2 (+) and 4 (-) while blowing air to hot wire.

Air blown: Approx. 0.8V
 No air blown: Approx. 2V

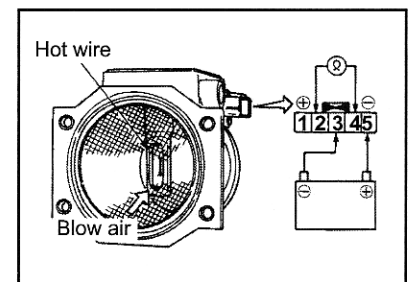

RB20E ENGINE

7. THROTTLE VALVE SWITCH SYSTEM

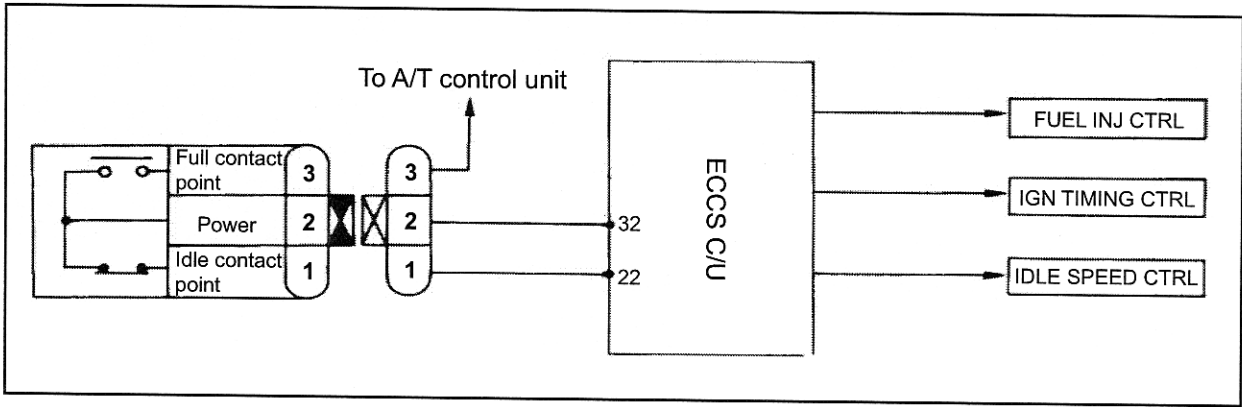

Throttle valve switch system trouble diagnosis flowchart RB20E ENGINE

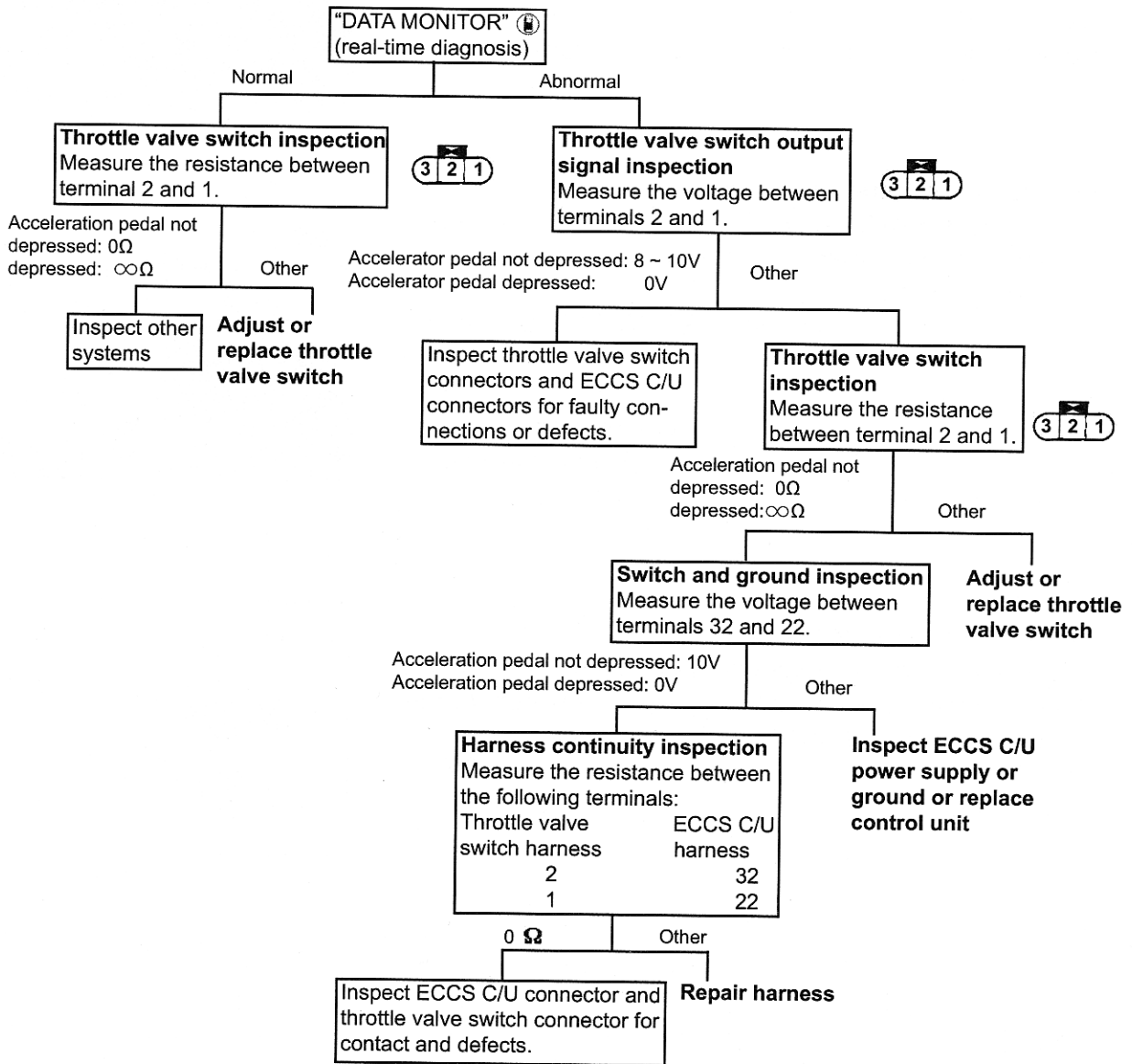

RB20E ENGINE

1 System inspection

- Use "DATA MONITOR" to inspect the idle contact point ON-OFF signal to make sure it is operating correctly.

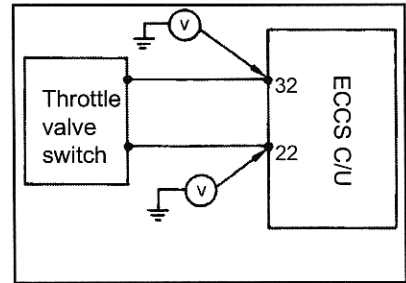

2 Input signal inspection

- Measure the power voltage between ECCS C/U terminal 22 and earth (or between throttle valve switch terminal 1 and earth) with ECCS control unit connector connected.

Ignition sw in ON position or engine running:
 Accelerator pedal not depressed: 8 ~ 10V
 Accelerator pedal depressed: 0V

- Measure power voltage between ECCS C/U terminal 32 and earth (or between throttle valve switch terminal 1 and earth) with ECCS control unit connectors connected.



Ignition sw in ON position: 8 ~ 10V

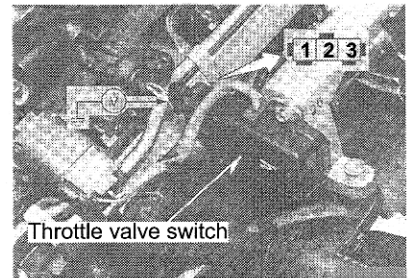

3 Throttle valve switch inspection (idle contact point)

- Disconnect throttle valve switch connectors and measure the resistance between throttle valve switch terminal 1 and 2.

Accelerator pedal not depressed: 0Ω
 Accelerator pedal depressed: ∞Ω

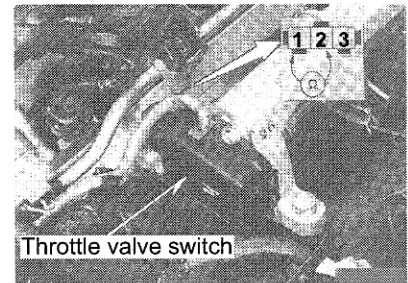

(4) Harness continuity inspection

- Disconnect throttle valve switch and ECCS control unit connectors and measure the resistance between the following terminals.

ECCS C/U harness 22 and throttle valve sw 1: 0Ω
 ECCS C/U harness 32 and throttle valve sw 2: 0Ω

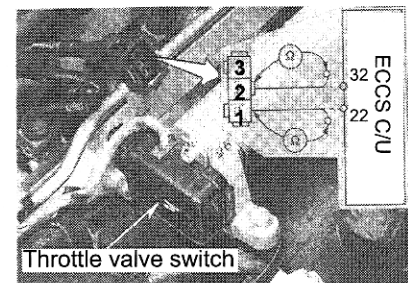

RB20E ENGINE

5 Idle contact point (touch speed) inspection and adjustment

- Warm up the engine sufficiently and use "IDLE SW"  in operation support mode to inspect idle contact point.

- Disconnect AAC valve connector and inspect the unit when the AAC valve is fully open. 

Idle contact point tachometer speed (rpm):

850+/- 150 rpm

- When the tachometer speed does not conform to the specified value, perform the adjustment as follows:
- Loosen the throttle valve switch tightening bolts (2).
- Remove the throttle valve switch connectors, place a test probe between the throttle valve switch terminals 1 and 2 and measure the resistance.
- Depress the accelerator pedal and gradually release the pedal to lower the engine speed. Rotate the throttle valve switch body and secure it in the position where the tachometer speed conforms to the specified value and the idle contact point is "ON" (the resistance between terminal 1 and 2 is 0Ω).
- Tighten the throttle valve switch tightening bolts.
- Make sure the idle is ON observing the tachometer speed as described above.
- Connect the throttle valve switch connectors.

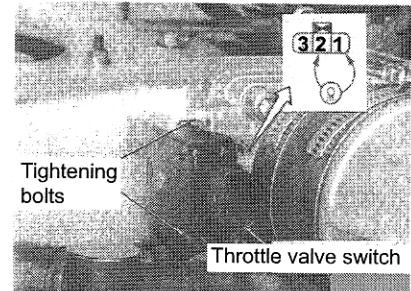
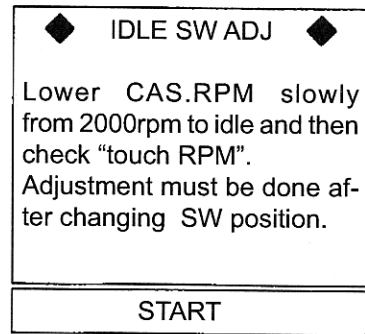

8. THROTTLE SENSOR SYSTEM

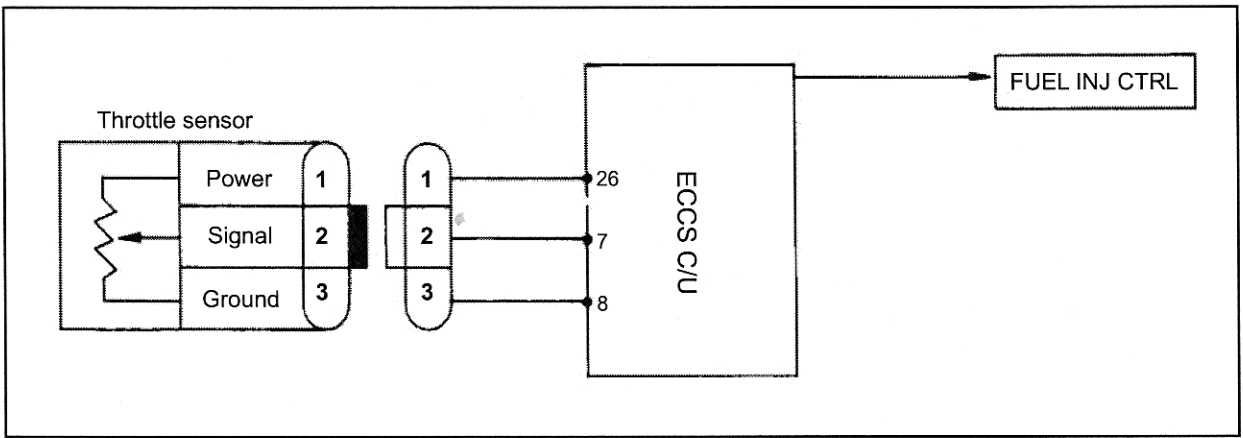

Throttle sensor system trouble diagnosis flowchart RB20E ENGINE

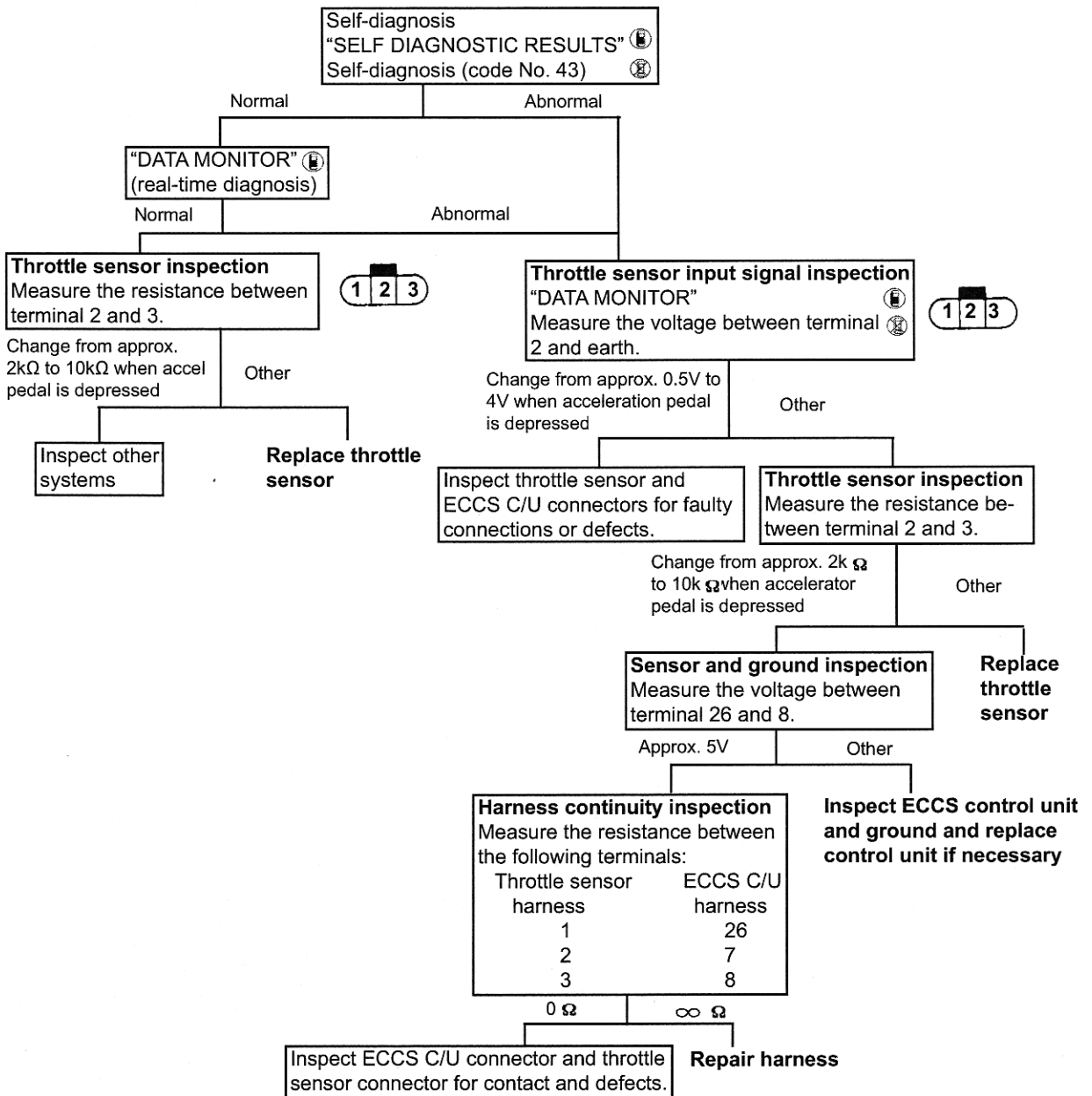



1. Self-diagnosis

- There is disconnection or short-circuit in the signal system when "CODE 43" is displayed in normal self-diagnosis (mode 2). When this is displayed, check the throttle sensor resistance or harness continuity etc.
- If the problem occurs again, use real-time diagnosis mode or oscilloscope to check for instantaneous break in the signal. 

2. Input signal inspection

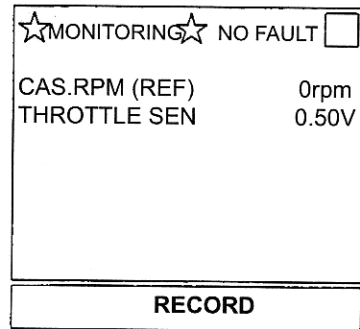
- Use "THROTTLE SENSOR" setting in data monitor mode to check the following items: 
 - Ignition sw in ON position accelerator pedal not depressed: Approx. 0.5V
 - Ignition sw in ON position accelerator pedal depressed to half-way: Approx. 0.5 ~ 4.0V
 - Ignition sw in ON position accelerator pedal depressed fully: Approx. 4.0V



- Measure power voltage between ECCS C/U terminal 7 and earth (or throttle sensor terminal 2 and earth) with throttle sensor harness connected. 
 - Ignition sw in ON position: Approx. 0.2V
 - Cranking: Approx. 0.2V
 - Engine running with accelerator pedal not pressed: Approx. 0.5V
 - Engine running with accelerator pedal depressed fully: Approx. 0.5 ~ 4.0V

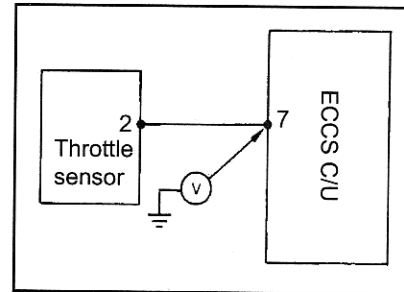

3. Throttle sensor power supply inspection

- Measure power voltage between throttle sensor terminal 1 and ground with throttle sensor connectors connected.
 - Ignition sw in ON position with engine running: Approx. 5V

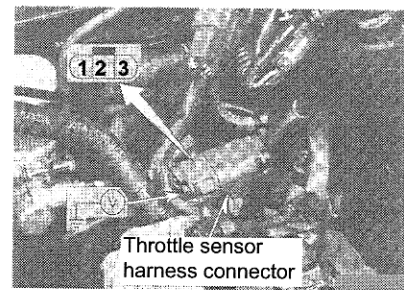

4 Throttle sensor unit inspection

- Disconnect the throttle sensor connector and measure the resistance between throttle sensor terminal 2 and 3.
 - Accelerator pedal not depressed: Approx. 2kΩ
 - Accelerator pedal partially depressed: 2kΩ ~ 10kΩ
 - Accelerator pedal fully depressed: Approx. 10kΩ

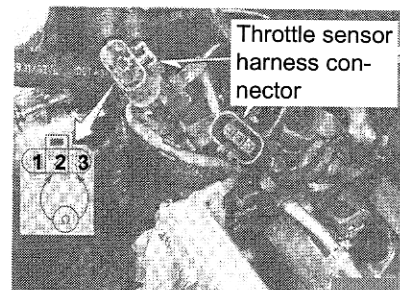

RB20E ENGINE

5 Harness continuity inspection

- Disconnect ECCS control unit and throttle sensor connector and measure the resistance between following terminals.

ECCS C/U harness 26 and throttle sensor harness 1:

ECCS C/U harness 7 and throttle sensor harness 2:

ECCS C/U harness 8 and throttle sensor harness 3:

Resistance (Ω): 0

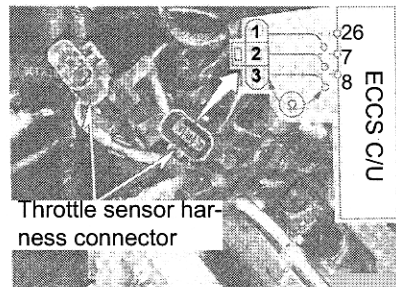

9. ENGINE TEMPERATURE SENSOR SYSTEM

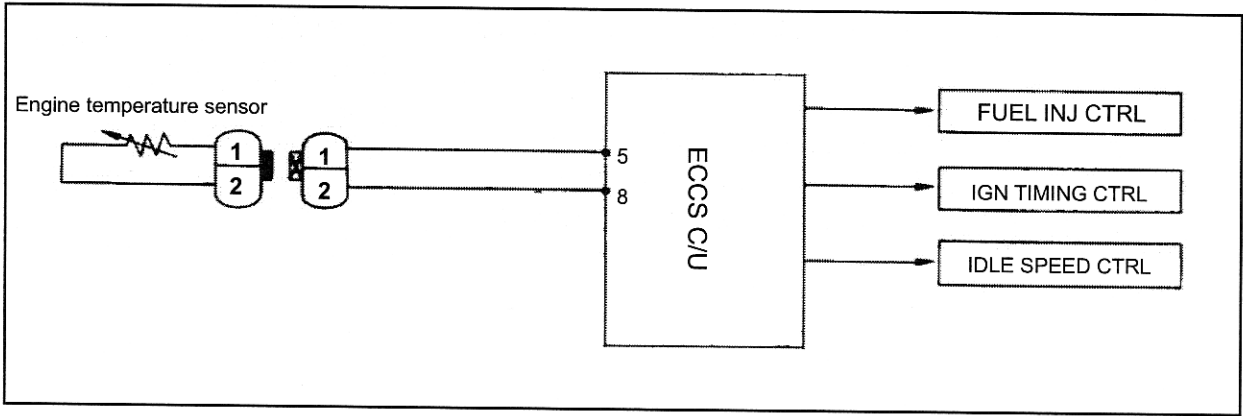

Engine temperature sensor system trouble diagnosis flowchart RB20E ENGINE

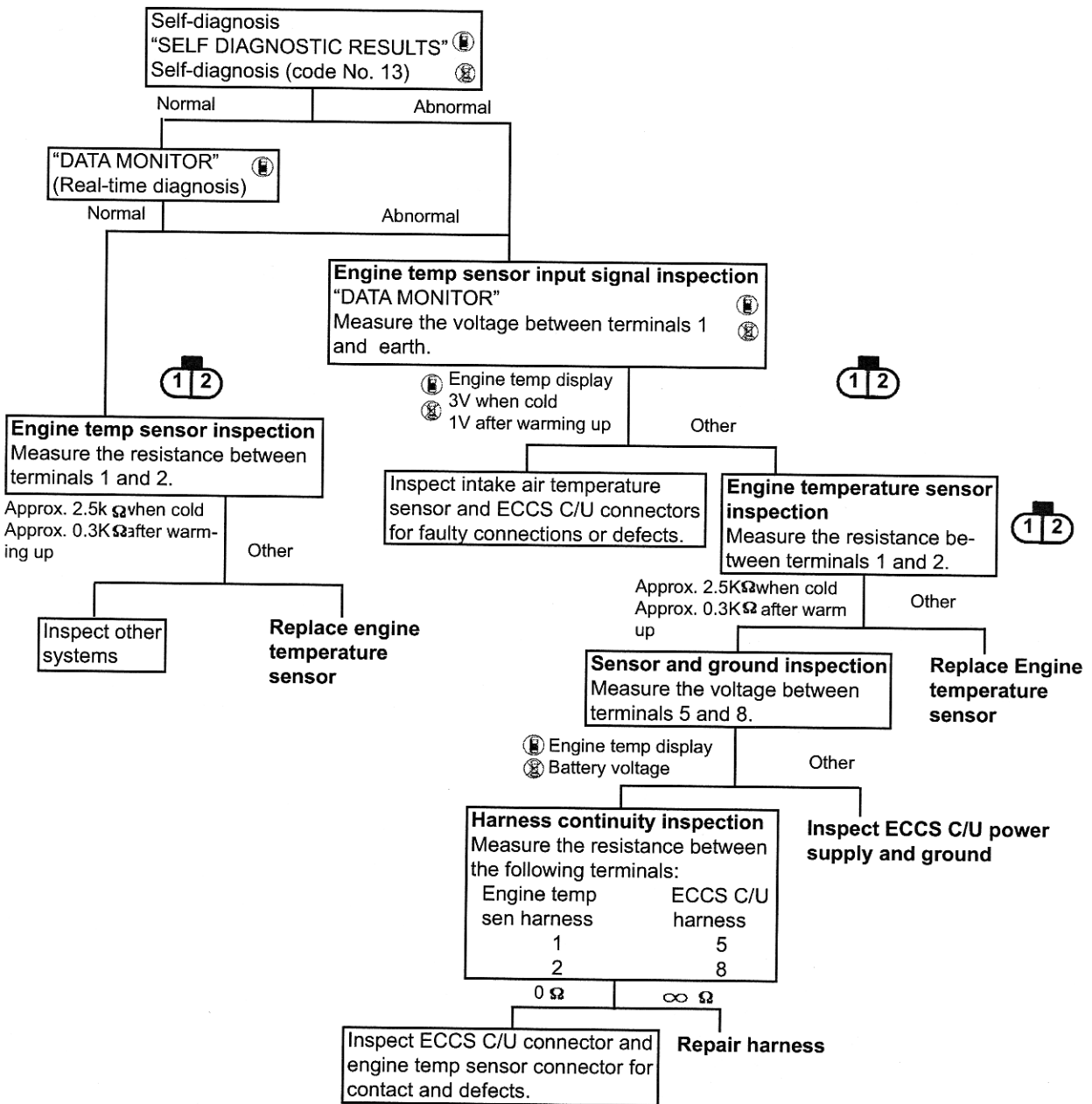

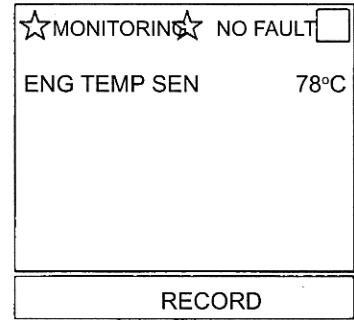

1 Self-diagnosis

- There is a disconnection or short-circuit in the signal system when “CODE 13” is displayed in normal self-diagnosis or “FAILURE DETECTED ENG TEMP SEN” (when CONSULT is used) is displayed.
- If the problem reoccurs, use real-time diagnosis mode or an oscilloscope to check for instantaneous break in the signal.



2 Input signal inspection

- Use the “ENG TEMP SEN” in data monitor mode  to check if the engine temperature is displayed when ignition sw in the ON position.

- Measure the voltage between ECCS C/U terminal 15 and ground with ECCS control unit connectors connected. 

Ignition sw in ON position with engine temp at 20°C:
Approx. 3V

Ignition sw in ON position with engine temp at 80°C:
Approx. 1V

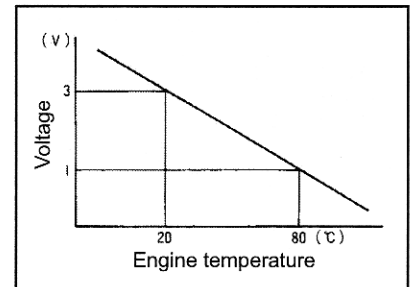
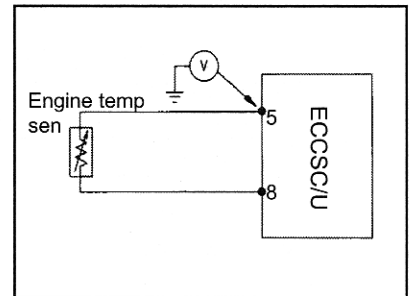

3 Engine temperature sensor resistance value inspection

- Disconnect engine temperature sensor connector and measure the resistance between engine temperature sensor connectors 1 and 2.

Engine temperature at 20°C: Approx. 2.5kΩ

Engine temperature at 80°C: Approx. 0.3kΩ

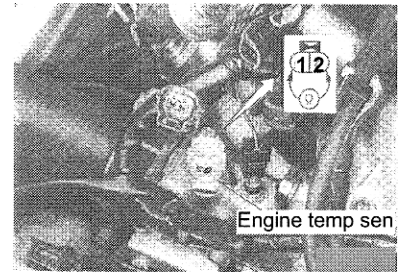

4 Harness continuity inspection

- Disconnect ECCS control unit and engine temperature sensor harness connector and measure the resistance between the following terminals:

ECCS C/U harness 5 & engine temp sen harness 1

ECCS C/U harness 8 & engine temp sen harness 2

Resistance (Ω): 0Ω

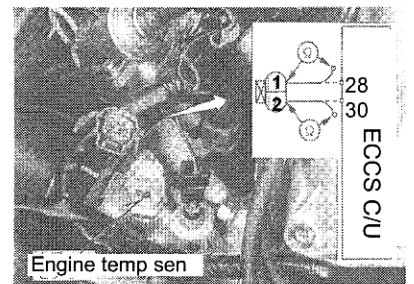

10. O₂ SENSOR SYSTEM

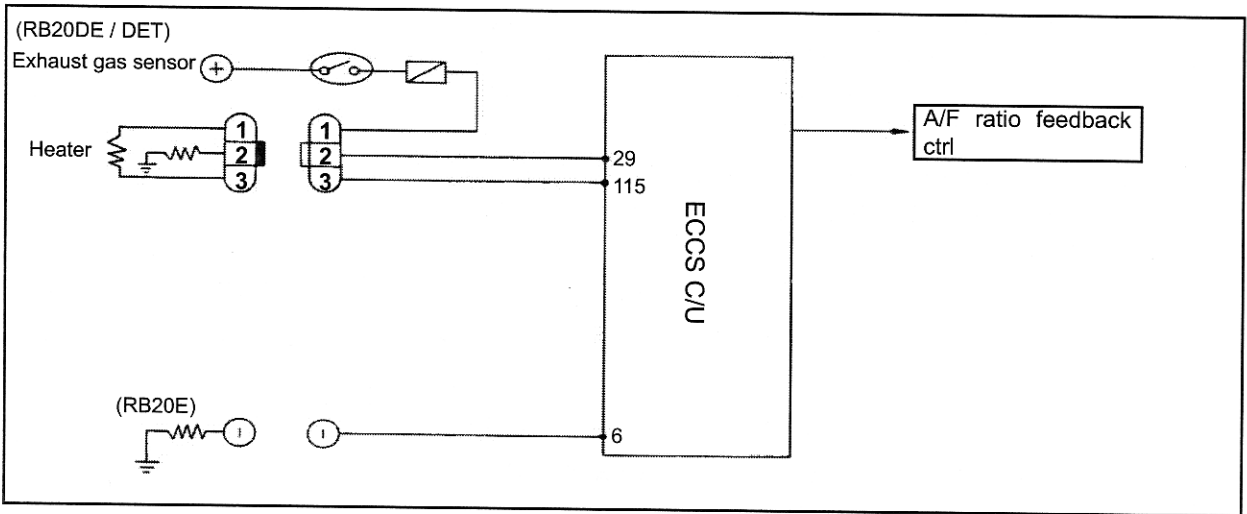

O₂ sensor system trouble diagnosis flowchart RB20E ENGINE

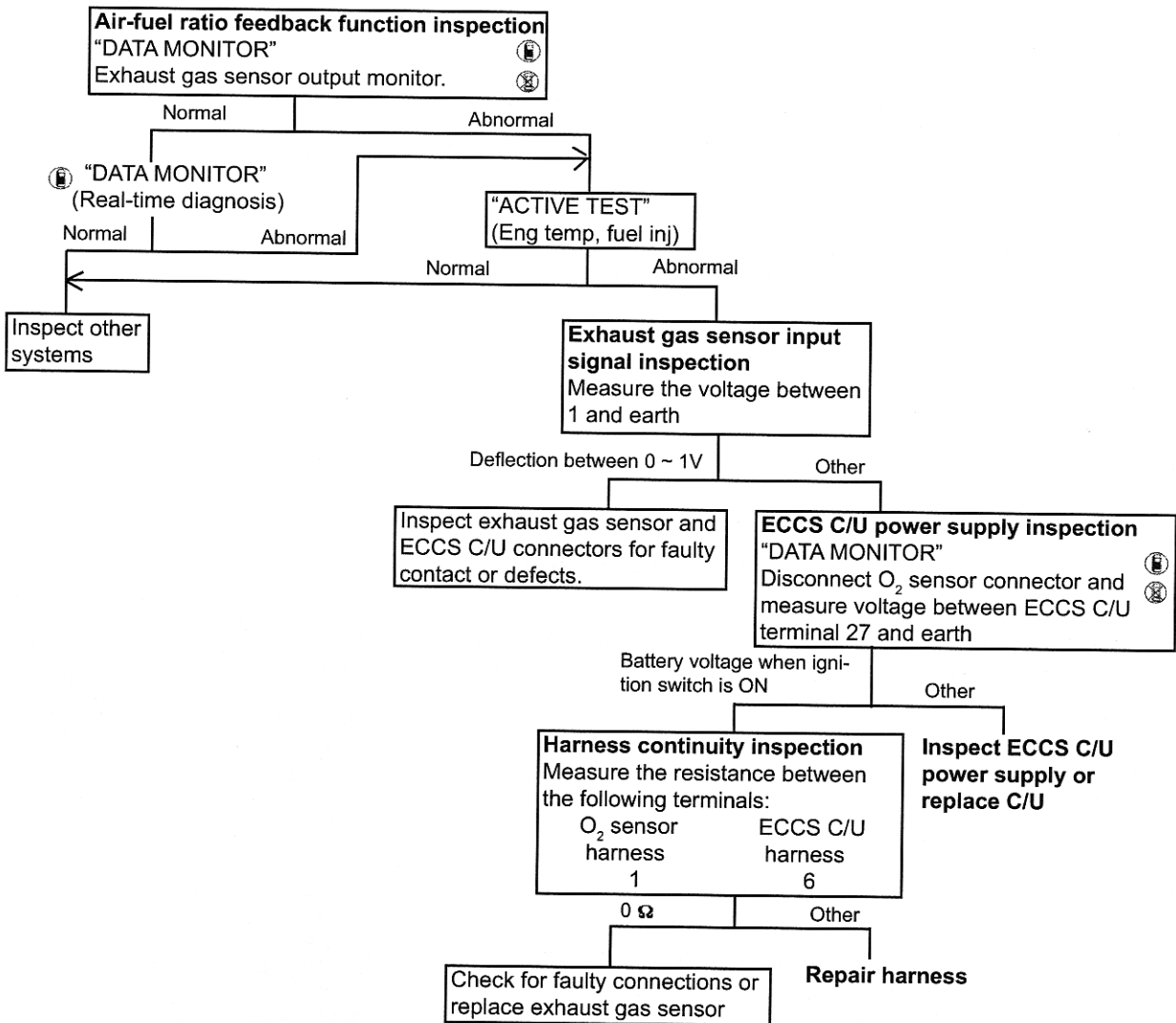

RB20E ENGINE

1 Fuel-air ratio feedback function inspection



- Warm up the engine and inspect the following items with "EXH GAS SEN" and "M/R F/C MNT" (lean / rich) displayed in data monitor mode.

Exhaust gas sensor at 2,000 rpm:

Output voltage is displayed at approx. 0 ~ 1V. The display cycle is 5 times or more in a 10 second interval.

Exhaust gas sensor monitor at 2,000rpm:

RICH / LEAN display must be synchronized with output voltage display.

- Provide setting value in "ACTIVE TEST" (fuel injection quantity correction) and check exhaust gas sensor function.

Note:

"INJ PULSE" display for RB20E is 1/16.

☆ MONITOR	☆ NO FAULT	<input type="checkbox"/>
CAS.RPM (POS)	2012rpm	
AIR FLOW MTR	1.54V	
ENG TEMP	80°C	
EXH GAS SEN	0.72V	
M/R F/C MNT	RICH	
RECORD		

◆ ACTIVE TEST	◆	<input type="checkbox"/>	
FUEL INJECTION	+11%		
MONITOR			
CAS.RPM (REF)	1037rpm		
ENG TEMP SEN	36°C		
EXH GAS SEN	0.87V		
INJ PULSE	4.0msec		
AAC VALVE	36%		
Qu	UP	DWN	Qd

- Using diagnosis connector on the vehicle side (near fuse block), set CONSULT to "EXHAUST GAS SENSOR MONITOR" and check the fuel injection condition by checking the flashing exhaust gas temperature warning lamp on the instrument panel.

Exhaust gas sensor function

Exhaust gas temperature warning lamp must flash 5 times or more in a 10 second interval when engine speed is at approx. 2,000 rpm.

Feedback function

Exhaust gas temperature warning lamp must flash periodically when engine speed is at approx. 2,000 rpm.

2 Input signal inspection

- Measure the voltage between ECCS C/U terminal 29 and ground with ECCS control unit harness connected.

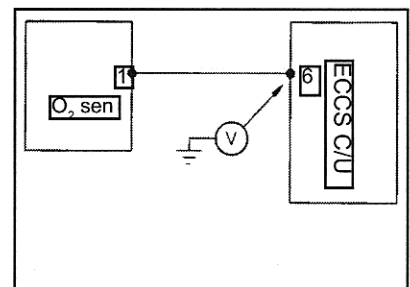

3 Harness continuity inspection

- Disconnect ECCS control unit and exhaust gas connectors and measure the resistance between ECCS C/U harness terminal 6 and O₂ sensor harness terminal 1.

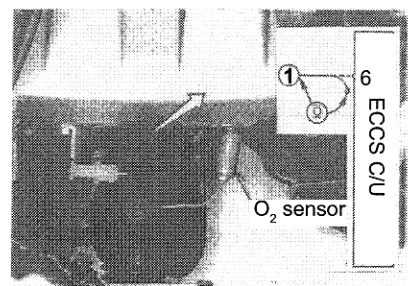

11. DETONATION SENSOR SYSTEM

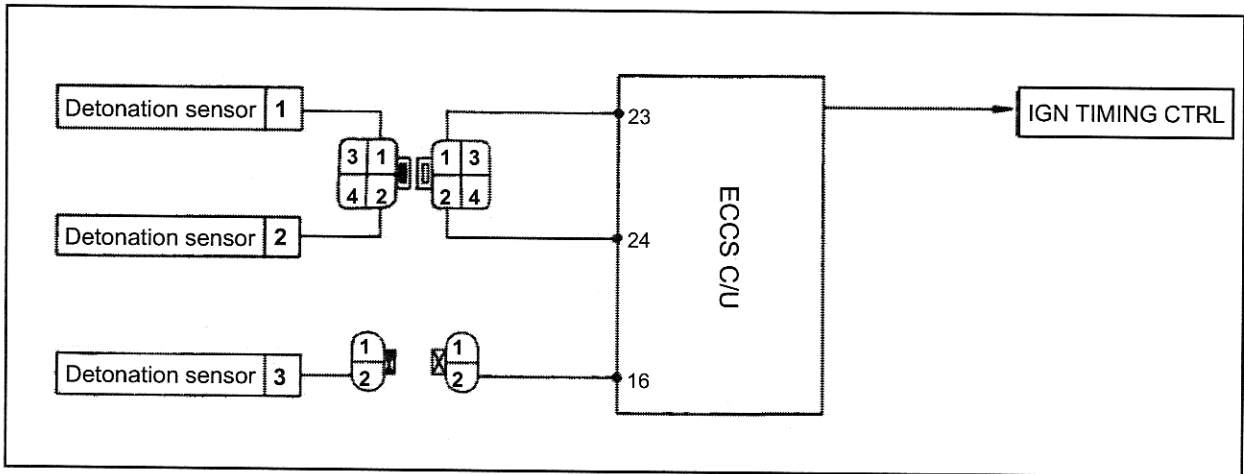

1 Self-diagnosis

- There is a disconnection or short-circuit in the signal system when “CODE 34” in normal self-diagnosis or “FAILURE DETECTED DETONATION SENSOR” (when CONSULT is used) is displayed. If the problem reoccurs, use real-time diagnosis mode (CONSULT data monitor mode) or an oscilloscope to check for an instantaneous break in the signal.

2 Input signal inspection

- Measure the voltage between ECCS C/U terminal 23 and earth with ECCS control unit harness connected.

Ignition sw in ON position:	Approx. 4V
Cranking:	Approx. 4V
Idling:	Approx. 4V

Caution:

The detonation sensor input signal must be measured by using oscilloscope as its resistance is greater than the circuit tester resistance. The signal should also be checked with self-diagnosis and harness continuity inspection.

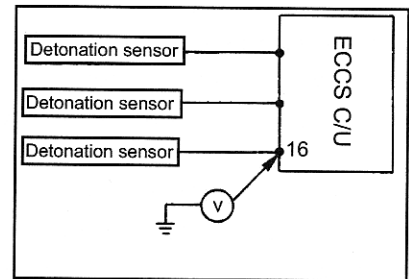

3 Harness continuity inspection

- Disconnect ECCS control unit and detonation sensor mid connector and measure the resistance between ECCS C/U terminal 16 and detonation sensor mid harness terminal 2.

Resistance (Ω): 0

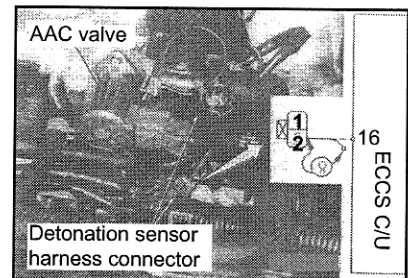

12. VEHICLE SPEED SENSOR SYSTEM

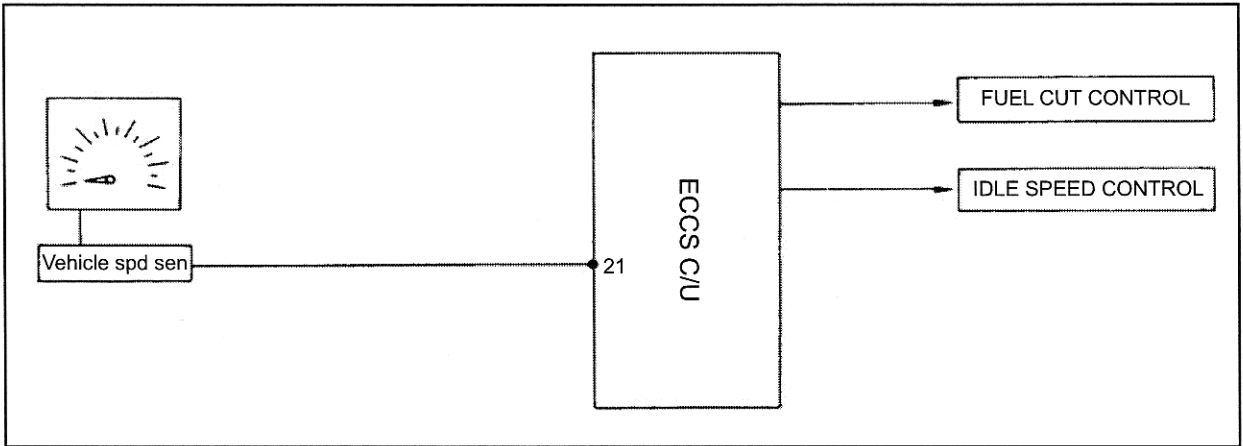

1 Input signal inspection

- Select "VEHICLE SPEED SENSOR" in data monitor mode and check if the vehicle speed is displayed when drive wheels are turning.

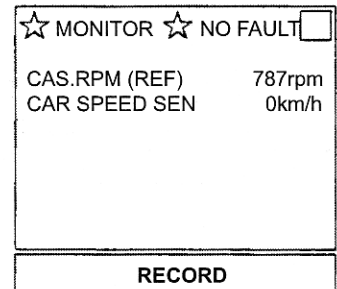

- Measure the voltage between ECCS C/U terminal 21 and earth with ECCS control unit connectors connected.



When drive wheels are turning slowly:
Voltage will deflect between 0V and 5V.

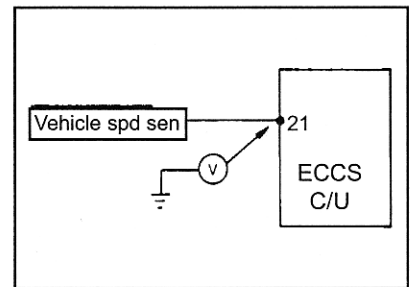

RB26DETT ENGINE

EN10 ECCS CONTROL UNIT INPUT / OUTPUT SIGNALS**1. CONSULT INSPECTION VALUES - RB26DETT ENGINE****(1.1) Data monitor**

Note: The output signal is displayed as the calculation data on console unit so the correct value will be displayed even if the output circuit (harness) is inadvertently disconnected.

MONITORING ITEMS	DATA MONITOR			PROBLEM INSPECTION ITEM
	CONDITION		NORMAL REFERENCE VALUE	
CAS.RPM (Detected angle speed according to signals)	Tachometer set Engine running		There must be no abnormal change in speed	Crank angle sensor system
AIR FLOW MTR (Output voltage)	After warming up the engine Idling (N range, A/C OFF)		Approx. 0.7 ~ 1.2V (2000rpm without load 1.0 ~ 1.7V) Note: 2 air-flow meter value can vary 0 ~ 0.4V	Air flow meter system
AIR FLOW MTR (R) (Output voltage)				
ENG TEMP SEN (Engine temperature)	After warming up the engine		Above approx. 70°C	Engine temperature sensor system
EXT GAS SEN (Output voltage)	After warming up the engine	2000rpm without load	Changes between 0 ~ 0.3V and 0.6 ~ 1V RICH. LEAN repeats 5 times or more in 10 seconds	Exhaust gas sensor system Intake system air leak or air intake Injector system
EXT GAS SEN (R) (Output voltage)				
EXT GAS SEN (RICH/LEAN)				
EXT GAS SEN (R) (RICH/LEAN)				
CAR SPEED SEN (Vehicle speed signal)	While driving or with drive wheels turning		Should generally conform to speedometer display	Vehicle speed sensor system
BATTERY VOLTAGE	Ignition sw in ON position Engine stopped		11 ~ 14V	Battery ECCS control unit power system
THROTTLE SEN (Output voltage)	Ignition sw in ON Engine stopped	Throttle fully closed	0.5	Throttle sensor adjustment
		Throttle fully open	4.0	Throttle sensor system
INT/A TEMP SEN (Intake temperature sensor output)	After warming up the engine		Intake air temperature is displayed	Intake temperature sensor system
INJ PULSE (Injection pulse width)	After warming up the engine	Idling (N range, A/C OFF)	Reference	1.4~2.2 msec
INJ PULSE (R) (Injection pulse width)		2000rpm without load		
IGN TIMING	After warming up the engine	Idling (N range, A/C OFF)	Approx. 15 ~ 35%	
		2000rpm without load	Approx. 30 ~ 50%	
AAC VALVE	After warming up the engine	Idling (N range, A/C OFF)	75 ~ 125%	
		2000rpm without load	Approx. 30 ~ 50%	
A/F ALPHA (Air-fuel ratio feedback correction coefficient)	After warming up the engine 2000rpm without load		75 ~ 125%	Air flow meter system Injector system Canister (purge) inspection Intake system air leak or air suction
START SIGNAL	Ignition sw in ON Engine stopped	"START"	ON	
		"OFF"	OFF	
IDLE SW		Throttle fully closed	ON	
		Throttle fully open	OFF	
AIR COND SIG	Idle	A/C SW ON	ON	
		A/C SW OFF	OFF	
NEUTRAL SW		N or P range	ON	
		Other than N or P	OFF	
PW/ST SIGNAL		Steering	ON	
		Steering neutral	OFF	
IDLE JUDGEMENT	When idling		ON	
	Other than idling		OFF	
FUEL PUMP RELAY	Ignition sw in ON	Stop	OFF	
		When revving	ON	
AIR CON RELAY	Idle	A/C ON	ON	
		A/C OFF	OFF	
	Accel 10 seconds	A/C ON	OFF	
W/G CONT S/V			ON	
			OFF	
POWER VOLTAGE	Display power voltage probe measurement value			
PULSE	Display pulse probe measurement value			

(1.2) Active test

SET ITEM	ACTIVE TEST		JUDGEMENT AND INSPECTION ITEM
	CONDITION	ACTIVE TEST DESCRIPTION	
ENGINE TEMPERATURE	Problem occurrence condition	Set engine temperature high or low. <u>Caution:</u> Do not set extreme values as this can cause spark plugs to burn.	Perform following inspections to check if problem is solved. <u>Eliminate:</u> Engine temperature sensor system Injector system Air flow meter, exhaust gas sensor system <u>Not eliminated:</u> Other item inspection
FUEL INJECTION	Problem occurrence condition	Set the air-fuel ratio rich or lean. <u>Caution:</u> Do not set extreme values as this may damage engine or catalytic converter	Perform following inspections to check if problem is solved. <u>Eliminate:</u> Exhaust gas sensor system Air flow meter, engine temperature sensor system Injector system <u>Not eliminated:</u> Other item inspection
IGNITION TIMING	Problem occurrence condition	Delay ignition timing. <u>Caution:</u> Do not set extreme values as this may damage engine or catalytic converter	Perform following inspections to check if problem is solved. <u>Eliminate:</u> Ignition timing adjustment Detonation sensor system <u>Not eliminated:</u> Other item inspection
AAC VALVE OPENING	Engine running	Increase control duty ratio. The engine speed should increase. Decrease control duty ratio. The engine speed should decrease.	If the condition described on left can not be verified, check AAC valve system
POWER BALANCE	Engine running	Set the AAC value open to stop the specified injector operation and the injector speed can be displayed at this time. <u>Caution:</u> Do not perform this operation while driving.	<u>Eliminate:</u> Injector system
FUEL PUMP RELAY	Ignition sw in ON Engine stopped	Turn ignition sw to ON, OFF and ON so the pump operation makes noise. The fuel pressure will rise. <u>Caution:</u> Do not perform this operation except under conditions described on left.	If the condition described on left can not be verified, check relay system of fuel pump and fuel pump system
SELF-LEARNING CONT	The air-fuel ratio feedback correction coefficient learning factor is learned.		

2. OSCILLOSCOPE & CIRCUIT TESTER INSPECTION VALVE (RB26DETT ENGINE)

101	102	103	104	105	106	107	108	1	2	3	4	5	6	7	8	9	10		21	22	23	24	25	26	27	28	29	30	41	42	43	44	45	46	47	48	49	50
109	110	111	112	113	114	115	116	11	12	13	14	15	16	17	18	19	20		31	32	33	34	35	36	37	38	39	40	51	52	53	54	55	56	57	58	59	60

RX	TX				CHK	IGN
-	CLK					

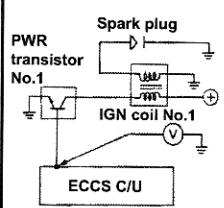
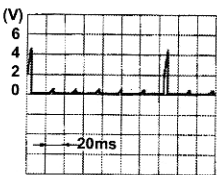
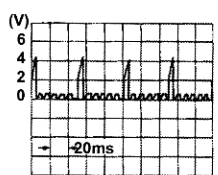
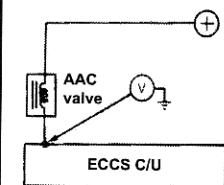
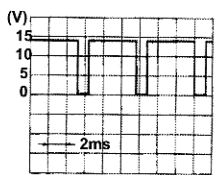
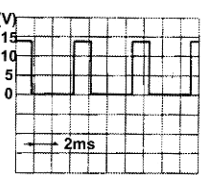
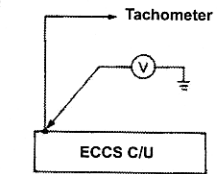
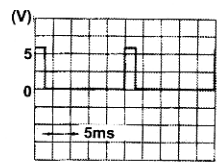
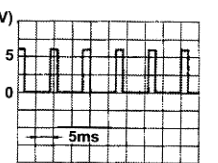
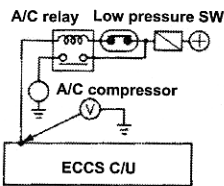
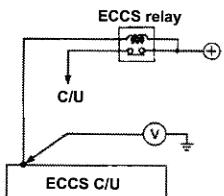
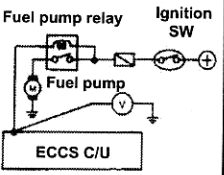
Terminal No.	Signal name	Circuit	At idle		At approx. 2,500 rpm	
			Standard	Memo	Standard	Memo
1 2 3 11 12 13	Power transistor control signal					
4	AAC valve control signal					
7	Engine speed signal for tachometer					
9	Air conditioner relay		Air conditioner OFF: Battery voltage Air conditioner ON: Approx. 1V		Air conditioner OFF: Battery voltage Air conditioner ON: Approx. 1V	
16	ECCS relay		Approx. 1V (Ignition sw OFF: Battery voltage)		Approx. 0V	
18	Fuel pump relay		0V		0V	

RB26DETT ENGINE

101	102	103	104	105	106	107	108	1	2	3	4	5	6	7	8	9	10		21	22	23	24	25	26	27	28	29	30	41	42	43	44	45	46	47	48	49	50
109	110	111	112	113	114	115	116	11	12	13	14	15	16	17	18	19	20		31	32	33	34	35	36	37	38	39	40	51	52	53	54	55	56	57	58	59	60

	RX	TX				CHK	IGN
	-	CLK					

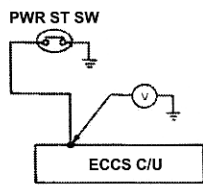
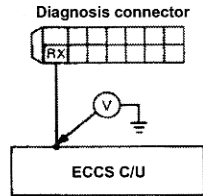
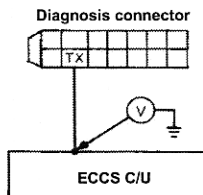
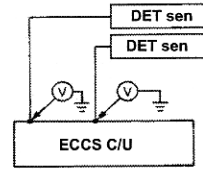
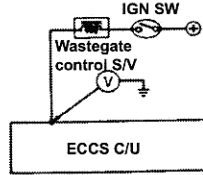
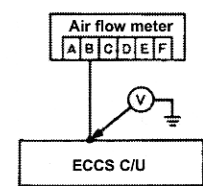
Terminal No.	Signal name	Circuit	At idle		At approx. 2,500 rpm	
			Standard	Memo	Standard	Memo
19	Power steering switch signal		Power steering ON: 0V Power steering OFF: 5V		Power steering ON: 0V Power steering OFF: 5V	
21 (RX)	Receive (Control unit data reception)		10V		10V	
22 (TX)	Transmit (Data transmission from control unit)		0V		0V	
23 24	Detonation sensor signal		Approx. 0.3V		Approx. 0.3V	
25	Wastegate valve control solenoid control signal		Battery voltage		Approx. 0V	
27	Air flow meter (rear) intake air quantity signal		Approx. 1V		Approx. 1.5V	

RB26DETT ENGINE

101	102	103	104	105	106	107	108	1	2	3	4	5	6	7	8	9	10		21	22	23	24	25	26	27	28	29	30	41	42	43	44	45	46	47	48	49	50
109	110	111	112	113	114	115	116	11	12	13	14	15	16	17	18	19	20		31	32	33	34	35	36	37	38	39	40	51	52	53	54	55	56	57	58	59	60

RX	TX				CHK	IGN
-	CLK					

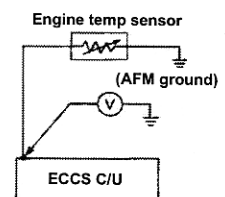
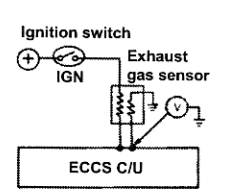
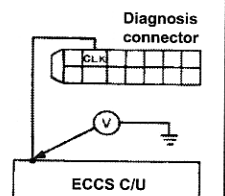
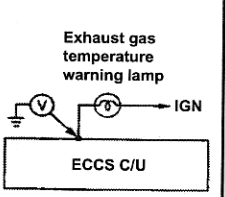
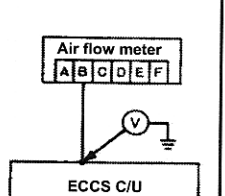
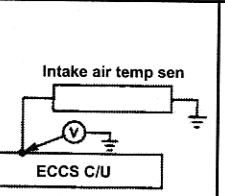
Terminal No.	Signal name	Circuit	At idle		At approx. 2,500 rpm	
			Standard	Memo	Standard	Memo
28	Engine temp sensor signal		Engine temperature 80°C: Approx. 1V Engine temperature 20°C: Approx. 3V		Engine temperature 80°C: Approx. 1V Engine temperature 20°C: Approx. 3V	
29	Exhaust gas sensor signal (front)		Approx. 0 ~ 1V		Deflects between approx. 0 ~ 1V	
31 (CLK)	Clock (synchronization signal)		0V		0V	
32	Motor & check lamp (red lamp)		Lamp not lit: Power voltage Lamp lit: 0V		Lamp not lit: Power voltage Lamp lit: 0V	
35	Air flow meter (front) intake air quantity signal		Approx. 1V		Approx. 1.5V	
36	Intake air temp sensor signal		Cold: Approx. 1.5V Warm: Approx. 0.8V		Cold: Approx. 1.5V Warm: Approx. 0.8V	

RB26DETT ENGINE

101	102	103	104	105	106	107	108	1	2	3	4	5	6	7	8	9	10		21	22	23	24	25	26	27	28	29	30	41	42	43	44	45	46	47	48	49	50
109	110	111	112	113	114	115	116	11	12	13	14	15	16	17	18	19	20		31	32	33	34	35	36	37	38	39	40	51	52	53	54	55	56	57	58	59	60

	RX	TX				CHK	IGN
	-	CLK					

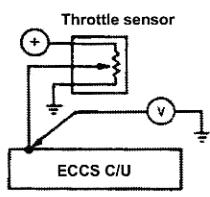
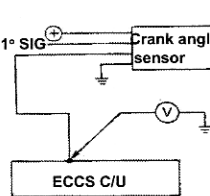
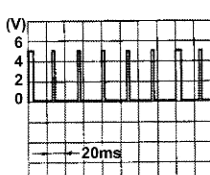
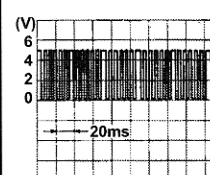
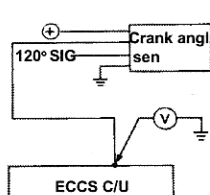
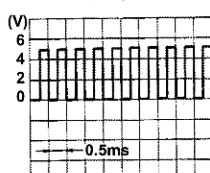
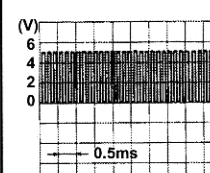
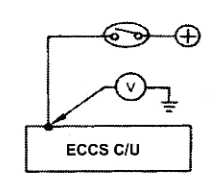
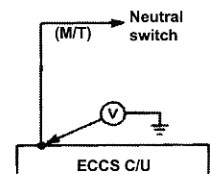
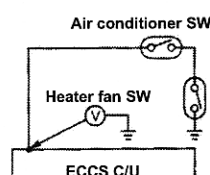
Terminal No.	Signal name	Circuit	At idle		At approx. 2,500 rpm		
			Standard	Memo	Standard	Memo	
38	Throttle sensor signal		Approx. 0.5V		Engine temperature 80°C: Approx. 1V Engine temperature 20°C: Approx. 3V		
41 51	Crank angle sensor 120° signal		0.3 ~ 0.7V				
42 52	Crank angle sensor 1° signal		2 ~ 3V				
43	Ignition switch (START signal)		0V (Ignition switch "START": Battery voltage)		0V		
44	Neutral switch signal		N or P range: 0V Other than N or P range: 4 ~ 5V		N or P range: 0V Other than N or P range: 4 ~ 5V		
46	Air conditioner switch signal		Air conditioner OFF: Battery voltage Air conditioner ON: 0V		Air conditioner OFF: Battery voltage Air conditioner ON: 0V		

RB26DETT ENGINE

101	102	103	104	105	106	107	108	1	2	3	4	5	6	7	8	9	10		21	22	23	24	25	26	27	28	29	30	41	42	43	44	45	46	47	48	49	50
109	110	111	112	113	114	115	116	11	12	13	14	15	16	17	18	19	20		31	32	33	34	35	36	37	38	39	40	51	52	53	54	55	56	57	58	59	60

O	RX	TX				CHK	IGN
	-	CLK					

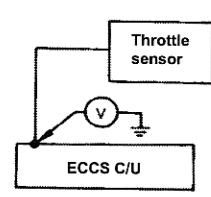
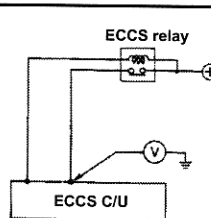
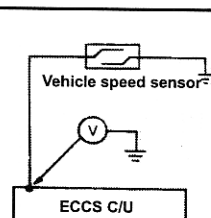
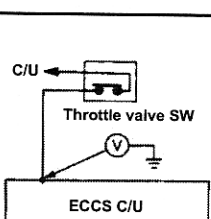
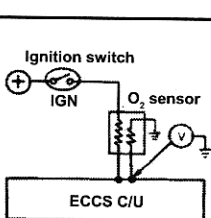
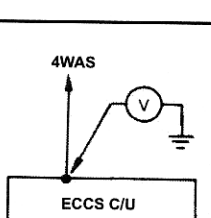
Terminal No.	Signal name	Circuit	At idle		At approx. 2,500 rpm	
			Standard	Memo	Standard	Memo
48	Throttle sensor (Power supply)		5V		5V	
49	Control unit power supply		Battery voltage		Battery voltage	
53	Vehicle speed sensor signal		D range (or 1st) with rear wheels jacked up: 0.5 ~ 1.5V The value actually deflects between 0V and 5V. However, it appears to deflect around 1V, according to vehicle speed.		D range (or 1st) with rear wheels jacked up: 0.5 ~ 1.5V The value actually deflects between 0V and 5V. However, it appears to deflect around 1V, according to vehicle speed.	
54	Throttle valve switch (idle contact point)		Approx. 10V		Approx. 10V	
55	Exhaust gas sensor signal (Rear)		N or P range: 0V Other than N or P range: 4 ~ 5V		N or P range: 0V Other than N or P range: 4 ~ 5V	
56	Throttle sensor output signal		Approx. 0.5V		Approx. 0.5 ~ 4V (Voltage increase as accelerator pedal is depressed)	

RB26DETT ENGINE

101	102	103	104	105	106	107	108	1	2	3	4	5	6	7	8	9	10	●	21	22	23	24	25	26	27	28	29	30	41	42	43	44	45	46	47	48	49	50
109	110	111	112	113	114	115	116	11	12	13	14	15	16	17	18	19	20		31	32	33	34	35	36	37	38	39	40	51	52	53	54	55	56	57	58	59	60

RX	TX				CHK	IGN
-	CLK					

Terminal No.	Signal name	Circuit	At idle		At approx. 2,500 rpm	
			Standard	Memo	Standard	Memo
57	Throttle valve switch (power supply)		Battery voltage		Battery voltage	
101 103 105 110 112 114	Injector control signal		Approx. Battery voltage 		Approx. Battery voltage 	
104	Fuel pump terminal voltage control signal (FPCM 1)		Idling (after warming engine): 0V		Idling (after warming engine): 0V	
106	Fuel pump terminal voltage control signal (FPCM 2)		-		During mid load: 0V	

RB20E ENGINE

1. CONSULT INSPECTION VALUES - RB20E ENGINE

(1.1) Data monitor

Note: The output signal is displayed as the calculation data on console unit so the correct value will be displayed even if the output circuit (harness) is inadvertently disconnected.

MONITORING ITEMS	DATA MONITOR		PROBLEM INSPECTION ITEM
	CONDITION	NORMAL REFERENCE VALUE	
CAS.RPM (Detected angle speed according to signals)	Tachometer set Engine running		There must be no abnormal change in speed Crank angle sensor system
AIR FLOW MTR (Output voltage)	After warming up the engine Idling (N range, A/C OFF)		Approx. 0.8 ~ 1.5V Air flow meter system
ENG TEMP SEN (Engine temperature)	After warming up the engine		Above approx. 70°C Engine temperature sensor system
EXT GAS SEN (Output voltage)	After warming up the engine	2000 rpm without load	Changes between 0 ~ 0.3V and 0.6 ~ 1V Exhaust gas sensor system Intake system air leak or air intake Injector system
EXT GAS SEN (RICH/LEAN)			RICH. LEAN repeats 5 times or more in 10 seconds
CAR SPEED SEN (Vehicle speed signal)	While driving or with drive wheels turning		Should generally conform to speedometer display Vehicle speed sensor system
BATTERY VOLTAGE	Ignition sw in ON position Engine stopped		11 ~ 14V Battery ECCS control unit power system
THROTTLE SEN (Output voltage)	Ignition sw in ON Engine stopped	Throttle fully closed	0.5 Throttle sensor adjustment
		Throttle fully open	4.0 Throttle sensor system
INJ PULSE (Injection pulse width) 1/16 display for RB20E	After warming up the engine	Idling (N range, A/C OFF)	Reference 2 ~ 3 msec 2 ~ 3 msec
		2000rpm without load	
IGN TIMING	After warming up the engine	Idling (N range, A/C OFF)	M/T15°, A/T20° Air flow meter system
		2000rpm without load	Advance greater than 10° angle compared to idle position
AAC VALVE	After warming up the engine	Idling (N range, A/C OFF)	Approx. 20 ~ 40% IAS adjustment
		2000rpm without load	Approx. 30 ~ 50% AAC valve system
A/F ALPHA (Air-fuel ratio feedback correction coefficient)	After warming up the engine 2000rpm without load		75 ~ 125% Air flow meter system Injector system Canister (purge) inspection Intake system air leak or air suction
START SIGNAL	Ignition sw in ON Engine stopped	"START"	ON Starter sw system
IDLE SW		"OFF"	OFF
	AIR COND SIG	Idle	Throttle fully closed
Throttle fully open			OFF
NEUTRAL SW	Idle	A/C SW ON	ON Air conditioner sw system
		A/C SW OFF	OFF
PW/ST SIGNAL	Idle	N or P range	ON Neutral sw system
		Other than N or P	OFF
FUEL PUMP RELAY	Ignition sw in ON	Steering	ON Power steering sw system
		Steering neutral	OFF
AIR CON RELAY	Idle	Stop	OFF Fuel pump system
		When revving	ON
AIR CON RELAY	Accel 10 seconds	A/C ON	ON Air conditioner relay system
		A/C OFF	OFF
		A/C ON	OFF

(1.2) Active test

SET ITEM	ACTIVE TEST		JUDGEMENT AND INSPECTION ITEM
	CONDITION	ACTIVE TEST DESCRIPTION	
ENGINE TEMPERATURE	Problem occurrence condition	Set engine temperature high or low. <u>Caution:</u> Do not set extreme values as this can cause spark plugs to burn.	Perform following inspections to check if problem is solved. <u>Eliminate:</u> Engine temperature sensor system Injector system Air flow meter, exhaust gas sensor system <u>Not eliminated:</u> Other item inspection
FUEL INJECTION	Problem occurrence condition	Set the air-fuel ratio rich or lean. <u>Caution:</u> Do not set extreme values as this may damage engine or catalytic converter	Perform following inspections to check if problem is solved. <u>Eliminate:</u> Exhaust gas sensor system Air flow meter, engine temperature sensor system Injector system <u>Not eliminated:</u> Other item inspection
IGNITION TIMING	Problem occurrence condition	Delay ignition timing. <u>Caution:</u> Do not set extreme values as this may damage engine or catalytic converter	Perform following inspections to check if problem is solved. <u>Eliminate:</u> Ignition timing adjustment Detonation sensor system <u>Not eliminated:</u> Other item inspection
AAC VALVE OPENING	Engine running	Increase control duty ratio. The engine speed should increase. Decrease control duty ratio. The engine speed should decrease.	If the condition described on left can not be verified, check AAC valve system
FUEL PUMP RELAY	Ignition sw in ON Engine stopped	Turn ignition sw to ON, OFF and ON so the pump operation will make noise. The fuel pressure will rise. <u>Caution:</u> Do not perform this operation except under conditions described on left.	If the condition described on left can not be verified, check relay system of fuel pump and fuel pump system
SELF-LEARNING CONT	The air-fuel ratio feedback correction coefficient learning factor is learned.		

2. OSCILLOSCOPE & CIRCUIT TESTER INSPECTION VALVE (RB20E ENGINE)

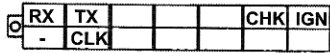
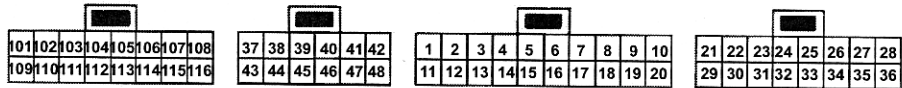

Terminal No.	Signal name	Circuit	At idle		At approx. 2,500 rpm	
			Standard	Memo	Standard	Memo
3	Air flow meter intake air quantity signal		Approx. 1V		Approx. 1.5V	
5	engine temperature sensor signal		Engine temperature 80°: Approx. 1V Engine temperature 20°: Approx. 3V		Engine temperature 80°: Approx. 1V Engine temperature 20°: Approx. 3V	
6	Exhaust gas sensor signal		Approx. 0 ~ 1V		Deflects between Approx. 0 ~ 1V	
7	Throttle sensor signal (input)		Approx. 0.5V		0.5 ~ 1V (Battery voltage will increase when accel pedal is depressed)	
9	Crank angle sensor 120° signal		0.3 ~ 0.7V		0.3 ~ 0.7V	
10	Crank angle sensor 1° signal		2 ~ 3V		2 ~ 3V	

RB20E ENGINE

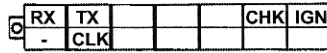

Terminal No.	Signal name	Circuit	At idle		At approx. 2,500 rpm	
			Standard	Memo	Standard	Memo
13	Monitor & check lamp (red lamp)		Lamp not lit: Power voltage Lamp is lit: Approx. 0V		Lamp not lit: Power voltage Lamp is lit: Approx. 0V	
15	Intake air quantity output signal (To A/T C/U)		Approx. 1V		Approx. 1V	
16	Detonation sensor signal		Approx. 4V		Approx. 4V	
17	Throttle opening output signal		Approx. 0.5V		0.5 ~ 1V (Battery voltage will increase when accelerator pedal is depressed)	
21	Vehicle speed sensor signal		D range (or 1st) with rear wheels jacked up: 0.5 ~ 1.5V The value actually deflects between 0 and 5V. However, it appears to deflect around 1V according to vehicle speed.		D range (or 1st) with rear wheels jacked up: 0.5 ~ 1.5V The value actually deflects between 0 and 5V. However, it appears to deflect around 1V according to vehicle speed.	
22	Throttle valve switch (Idle contact point)		Approx. 10V		0V when accelerator pedal is depressed	

RB20E ENGINE

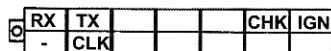
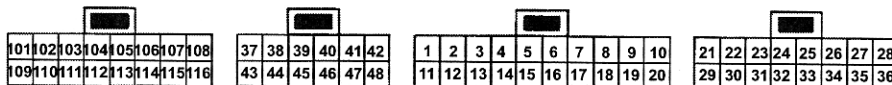

Terminal No.	Signal name	Circuit	At idle		At approx. 2,500 rpm	
			Standard	Memo	Standard	Memo
23	Ignition switch (START signal)		0 (Ignition switch at START: Power voltage)		0V	
24	Neutral switch signal		N or P range: 0V Other than N or P range: Approx. 6V		N or P range: 0V Other than N or P range: Approx. 6V	
25	Ignition switch (ON signal)		Power voltage		Power voltage	
26	Throttle sensor signal (Power supply)		5V		5V	
27	Control unit power supply		Power voltage		Power voltage	
29	Air conditioner switch signal		Air conditioner OFF: Power voltage Air conditioner ON: Approx. 0V		Air conditioner OFF: Power voltage Air conditioner ON: Approx. 0V	

RB20E ENGINE

RB20E ENGINE																																																																																		
<div style="display: flex; justify-content: space-around; align-items: flex-start;"> <div style="text-align: center;"> <table border="1" style="border-collapse: collapse;"> <tr><td>101</td><td>02</td><td>103</td><td>04</td><td>105</td><td>06</td><td>107</td><td>108</td></tr> <tr><td>109</td><td>110</td><td>111</td><td>112</td><td>113</td><td>114</td><td>115</td><td>116</td></tr> </table> </div> <div style="text-align: center;"> <table border="1" style="border-collapse: collapse;"> <tr><td>37</td><td>38</td><td>39</td><td>40</td><td>41</td><td>42</td></tr> <tr><td>43</td><td>44</td><td>45</td><td>46</td><td>47</td><td>48</td></tr> </table> </div> <div style="text-align: center;"> <table border="1" style="border-collapse: collapse;"> <tr><td>1</td><td>2</td><td>3</td><td>4</td><td>5</td><td>6</td><td>7</td><td>8</td><td>9</td><td>10</td></tr> <tr><td>11</td><td>12</td><td>13</td><td>14</td><td>15</td><td>16</td><td>17</td><td>18</td><td>19</td><td>20</td></tr> </table> </div> <div style="text-align: center;"> <table border="1" style="border-collapse: collapse;"> <tr><td>21</td><td>22</td><td>23</td><td>24</td><td>25</td><td>26</td><td>27</td><td>28</td></tr> <tr><td>29</td><td>30</td><td>31</td><td>32</td><td>33</td><td>34</td><td>35</td><td>36</td></tr> </table> </div> </div> <table border="1" style="border-collapse: collapse; width: 100%;"> <tr> <td style="width: 25px;">RX</td> <td style="width: 25px;">TX</td> <td style="width: 25px;"></td> <td style="width: 25px;"></td> <td style="width: 25px;">CHK</td> <td style="width: 25px;">IGN</td> </tr> <tr> <td style="text-align: center;">-</td> <td style="text-align: center;">CLK</td> <td></td> <td></td> <td></td> <td></td> </tr> </table>							101	02	103	04	105	06	107	108	109	110	111	112	113	114	115	116	37	38	39	40	41	42	43	44	45	46	47	48	1	2	3	4	5	6	7	8	9	10	11	12	13	14	15	16	17	18	19	20	21	22	23	24	25	26	27	28	29	30	31	32	33	34	35	36	RX	TX			CHK	IGN	-	CLK				
101	02	103	04	105	06	107	108																																																																											
109	110	111	112	113	114	115	116																																																																											
37	38	39	40	41	42																																																																													
43	44	45	46	47	48																																																																													
1	2	3	4	5	6	7	8	9	10																																																																									
11	12	13	14	15	16	17	18	19	20																																																																									
21	22	23	24	25	26	27	28																																																																											
29	30	31	32	33	34	35	36																																																																											
RX	TX			CHK	IGN																																																																													
-	CLK																																																																																	
Terminal No.	Signal name	Circuit	At idle		At approx. 2,500 rpm																																																																													
			Standard	Memo	Standard	Memo																																																																												
32	Throttle valve switch (power supply)		Power voltage		Power voltage																																																																													
37	Power transistor control signal		0.2 ~ 0.3V		Approx. 1V																																																																													
38	Power steering switch signal		Power steering ON: 0V Power steering OFF: Approx. 5V		Power steering ON: 0V Power steering OFF: Approx. 5V																																																																													
39	Tachometer signal		Power voltage		Approx. 10V																																																																													
40	ECCS relay		Approx. 1V (ignition switch OFF: Power voltage)		0V																																																																													
43	Tachometer engine rev signal		Approx. 1V		Approx. 3V																																																																													

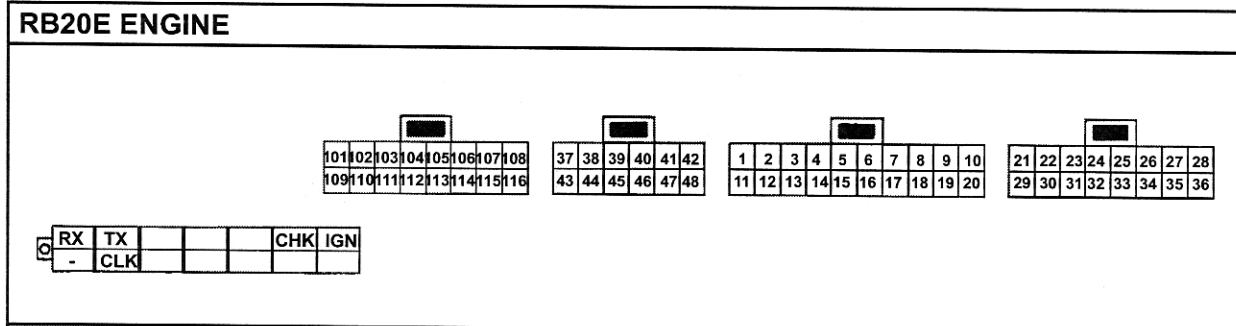

Terminal No.	Signal name	Circuit	At idle		At approx. 2,500 rpm	
			Standard	Memo	Standard	Memo
44	Engine A/T total control input signal (DT 1)		Approx. 10v		Approx. 10V	
45	Engine A/T total control input signal (DT 2)					
46	Air conditioner relay		Air conditioner OFF: Power voltage Air conditioner ON: 0V		Air conditioner OFF: Power voltage Air conditioner ON: 0V	
47	Engine A/T total control output signal (DT 3)		0V		0V	
101 103 105 110 112 114	Injector control signal		Almost power voltage		Almost power voltage	
104	Fuel pump relay		0V		0V	

RB20E ENGINE

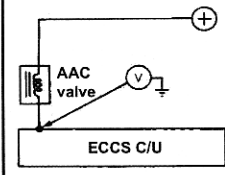
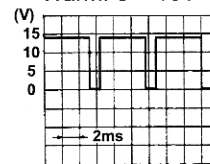
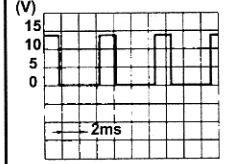
RB20E ENGINE																																																																																																
<div style="display: flex; justify-content: space-around; align-items: flex-start;"> <div style="text-align: center;"> <table border="1" style="border-collapse: collapse; margin-bottom: 5px;"> <tr><td style="width: 15px;">10</td><td style="width: 15px;">11</td><td style="width: 15px;">12</td><td style="width: 15px;">13</td><td style="width: 15px;">14</td><td style="width: 15px;">15</td><td style="width: 15px;">16</td></tr> <tr><td>101</td><td>102</td><td>103</td><td>104</td><td>105</td><td>106</td><td>107</td></tr> <tr><td>108</td><td>109</td><td>110</td><td>111</td><td>112</td><td>113</td><td>114</td></tr> <tr><td>115</td><td>116</td><td></td><td></td><td></td><td></td><td></td></tr> </table> </div> <div style="text-align: center;"> <table border="1" style="border-collapse: collapse; margin-bottom: 5px;"> <tr><td style="width: 15px;">37</td><td style="width: 15px;">38</td><td style="width: 15px;">39</td><td style="width: 15px;">40</td><td style="width: 15px;">41</td><td style="width: 15px;">42</td></tr> <tr><td>43</td><td>44</td><td>45</td><td>46</td><td>47</td><td>48</td></tr> </table> </div> <div style="text-align: center;"> <table border="1" style="border-collapse: collapse; margin-bottom: 5px;"> <tr><td style="width: 15px;">1</td><td style="width: 15px;">2</td><td style="width: 15px;">3</td><td style="width: 15px;">4</td><td style="width: 15px;">5</td><td style="width: 15px;">6</td><td style="width: 15px;">7</td><td style="width: 15px;">8</td><td style="width: 15px;">9</td><td style="width: 15px;">10</td></tr> <tr><td>11</td><td>12</td><td>13</td><td>14</td><td>15</td><td>16</td><td>17</td><td>18</td><td>19</td><td>20</td></tr> </table> </div> <div style="text-align: center;"> <table border="1" style="border-collapse: collapse; margin-bottom: 5px;"> <tr><td style="width: 15px;">21</td><td style="width: 15px;">22</td><td style="width: 15px;">23</td><td style="width: 15px;">24</td><td style="width: 15px;">25</td><td style="width: 15px;">26</td><td style="width: 15px;">27</td><td style="width: 15px;">28</td></tr> <tr><td>29</td><td>30</td><td>31</td><td>32</td><td>33</td><td>34</td><td>35</td><td>36</td></tr> </table> </div> </div> <div style="display: flex; justify-content: space-between; align-items: center;"> <table border="1" style="border-collapse: collapse; margin-right: 20px;"> <tr><td style="width: 20px;">RX</td><td style="width: 20px;">TX</td><td style="width: 20px;"></td><td style="width: 20px;"></td><td style="width: 20px;"></td><td style="width: 20px;"></td></tr> <tr><td style="text-align: center;">-</td><td style="text-align: center;">CLK</td><td></td><td></td><td></td><td></td></tr> </table> <table border="1" style="border-collapse: collapse;"> <tr><td style="width: 20px;">CHK</td><td style="width: 20px;">IGN</td></tr> </table> </div>							10	11	12	13	14	15	16	101	102	103	104	105	106	107	108	109	110	111	112	113	114	115	116						37	38	39	40	41	42	43	44	45	46	47	48	1	2	3	4	5	6	7	8	9	10	11	12	13	14	15	16	17	18	19	20	21	22	23	24	25	26	27	28	29	30	31	32	33	34	35	36	RX	TX					-	CLK					CHK	IGN
10	11	12	13	14	15	16																																																																																										
101	102	103	104	105	106	107																																																																																										
108	109	110	111	112	113	114																																																																																										
115	116																																																																																															
37	38	39	40	41	42																																																																																											
43	44	45	46	47	48																																																																																											
1	2	3	4	5	6	7	8	9	10																																																																																							
11	12	13	14	15	16	17	18	19	20																																																																																							
21	22	23	24	25	26	27	28																																																																																									
29	30	31	32	33	34	35	36																																																																																									
RX	TX																																																																																															
-	CLK																																																																																															
CHK	IGN																																																																																															
Terminal No.	Signal name	Circuit	At idle		At approx. 2,500 rpm																																																																																											
			Standard	Memo	Standard	Memo																																																																																										
113	AAC valve control signal		<p>Cold: 6 ~ 7V Warm: 8 ~ 10V</p> 		<p>Approx. 4 ~ 5V</p> 																																																																																											

1. CONSULT INSPECTION VALUES - RB25DE / RB25DET ENGINE

(1.1) Data monitor

Note: The output signal is displayed as the calculation data on console unit so the correct value will be displayed even if the output circuit (harness) is inadvertently disconnected.

MONITORING ITEMS	DATA MONITOR		PROBLEM INSPECTION ITEM
	CONDITION	NORMAL REFERENCE VALUE	
CAS.RPM (Detected angle speed according to signals)	Tachometer set Engine running		There must be no abnormal change in speed Crank angle sensor system
AIR FLOW MTR (Output voltage)	After warming up the engine Idling (N range, A/C OFF)	Idling 2,000rpm without load	Approx. 1.0 ~ 1.5V Air flow meter system
ENG TEMP SEN (Engine temperature)	After warming up the engine		Above approx. 70°C Engine temperature sensor system
EXT GAS SEN (Output voltage)	After warming up the engine	2000rpm without load	Changes between 0 ~ 0.3V and 0.6 ~ 1V Exhaust gas sensor system
EXT GAS SEN (RICH/LEAN)			RICH. LEAN repeats 5 times or more in 10 seconds Intake system air leak or air intake Injector system
CAR SPEED SEN (Vehicle speed signal)	While driving or with drive wheels turning		Should generally conform to speedometer display Vehicle speed sensor system
BATTERY VOLTAGE	Ignition sw in ON position Engine stopped		11 ~ 14V Battery ECCS control unit power system
INJ PULSE (Injection pulse width)	After warming up the engine	Idling (N range, A/C OFF)	Approx. 2.0 ~ 2.8msec
		2,000 rpm without load	Approx. 2.0 ~ 2.8msec
IGN TIMING	After warming up the engine	Idling (N range, A/C OFF)	15°
		2000rpm without load	Advance greater than 10° angle compared to idle position
AAC VALVE	After warming up the engine	Idling (N range, A/C OFF)	Approx. 12 ~ 30% IAS adjustment AAC valve system
A/F ALPHA (Air-fuel ratio feedback correction coefficient)	After warming up the engine 2000rpm without load		75 ~ 125% Air flow meter system Injector system Canister (purge) inspection Intake system air leak or air suction
START SIGNAL	Ignition sw in ON Engine stopped	"START"	ON
IDLE JUDGEMENT		"OFF"	OFF
AIR COND SIG	Idle	Throttle fully closed	ON
		Throttle fully open	OFF
NEUTRAL SW	Idle	A/C SW ON	ON
		A/C SW OFF	OFF
PW/ST SIGNAL	Idle	N or P range	ON
		Other than N or P	OFF
AIR CON RELAY	Idle	Steering	ON
		Steering neutral	OFF
FUEL PUMP RELAY	Ignition sw in ON	A/C SW ON	ON
		A/C SW OFF	OFF
THROTTLE SEN (output voltage)	Ignition sw in ON Engine stopped	A/C SW ON	OFF
		Stop	OFF
POWER VOLTAGE PULSE	Ignition sw in ON Engine stopped	When revving	ON
		Throttle fully closed	Approx. 4.0
		Throttle fully open	Approx. 0.5
Display power voltage probe measurement value			
Display pulse probe measurement value			

(1.2) Active test

SET ITEM	ACTIVE TEST		JUDGEMENT AND INSPECTION ITEM
	CONDITION	ACTIVE TEST DESCRIPTION	
ENGINE TEMPERATURE	Problem occurrence condition	Set engine temperature high or low. <u>Caution:</u> Do not set extreme values as this can cause spark plugs to burn.	Perform following inspections to check if problem is solved. <u>Eliminated:</u> Engine temperature sensor system Injector system Air flow meter, exhaust gas sensor system <u>Not eliminated:</u> Other item inspection
FUEL INJECTION	Problem occurrence condition	Set the air-fuel ratio rich or lean. <u>Caution:</u> Do not set extreme values as this may damage engine or catalytic converter	Perform following inspections to check if problem is solved. <u>Eliminated:</u> Exhaust gas sensor system Air flow meter, engine temperature sensor system Injector system <u>Not eliminated:</u> Other item inspection
IGNITION TIMING	Problem occurrence condition	Delay ignition timing. <u>Caution:</u> Do not set extreme values as this may damage engine or catalytic converter	Perform following inspections to check if problem is solved. <u>Eliminated:</u> Ignition timing adjustment Detonation sensor system <u>Not eliminated:</u> Other item inspection
AAC VALVE OPENING	Engine running	Increase control duty ratio. The engine speed should increase. Decrease control duty ratio. The engine speed should decrease.	If the condition described on left can not be verified, check AAC valve system
POWER BALANCE	Engine running	Set the AAC value open to stop the specified injector operation and the injector speed can be displayed at this time. <u>Caution:</u> Do not perform this operation while driving.	<u>Eliminated:</u> Injector system
FUEL PUMP RELAY	Ignition sw in ON Engine stopped	Turn ignition sw to ON, OFF and ON so the pump operation will makes noise. The fuel pressure will rise. <u>Caution:</u> Do not perform this operation except under conditions described on left.	If the condition described on left can not be verified, check relay system of fuel pump and fuel pump system
SELF-LEARNING CONT	The air-fuel ratio feedback correction coefficient learning factor is learned.		

2. OSCILLOSCOPE & CIRCUIT TESTER INSPECTION VALVE (RB25DE / DET ENGINE)

101	102	103	04	105	106	107	108	1	2	3	4	5	6	7	8	9	10		21	22	23	24	25	26	27	28	29	30	41	42	43	44	45	46	47	48	49	50
109	110	111	112	113	114	115	116	11	12	13	14	15	16	17	18	19	20		31	32	33	34	35	36	37	38	39	40	51	52	53	54	55	56	57	58	59	60

<input type="checkbox"/>	RX	TX				CHK	IGN
	-	CLK					

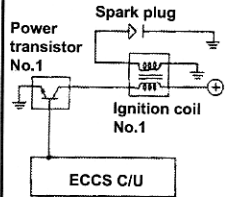
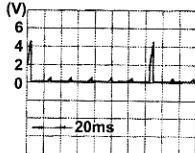
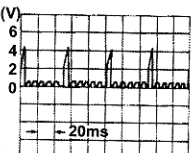
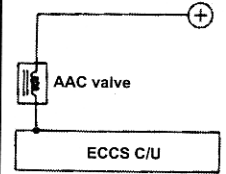
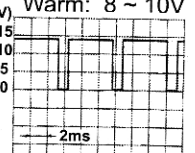
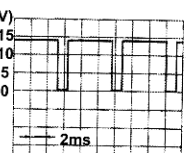
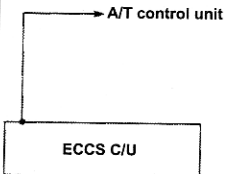
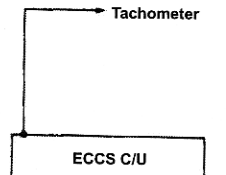
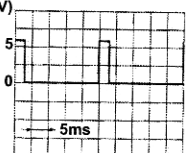
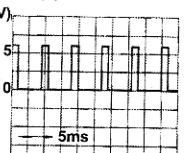
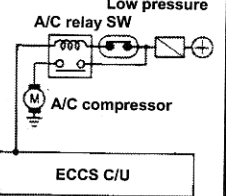
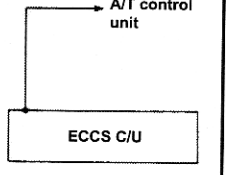
Terminal No.	Signal name	Circuit	At idle		At approx. 2,500 rpm	
			Standard	Memo	Standard	Memo
1 2 3 11 12 13	Power transistor control signal		0.2 ~ 0.3V 		Approx. 0.4V 	
4	AAC valve control signal		Cold: 6 ~ 7V Warm: 8 ~ 10V 		Approx. 5V 	
5	Engine A/T total control input signal (DT 1)		Approx. 10V		Approx. 10V	
7	Tachometer engine speed signal		Approx. 1V 		Approx. 2.4V 	
9	Air conditioner relay		Air conditioner OFF: Battery voltage Air conditioner ON: Approx. 1V		Air conditioner OFF: Battery voltage Air conditioner ON: Approx. 1V	
14	Engine A/T total control input signal (DT 2)		Approx. 10V		Approx. 10V	

RB25DE / RB25DET ENGINE

101	102	103	104	105	106	107	108	1	2	3	4	5	6	7	8	9	10		21	22	23	24	25	26	27	28	29	30	41	42	43	44	45	46	47	48	49	50
109	110	111	112	113	114	115	116	11	12	13	14	15	16	17	18	19	20		31	32	33	34	35	36	37	38	39	40	51	52	53	54	55	56	57	58	59	60

RX	TX				CHK	IGN
-	CLK					

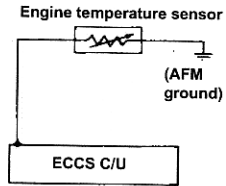
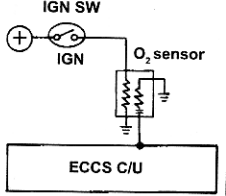
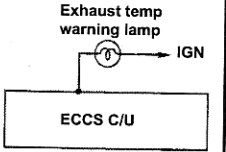
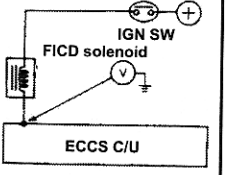
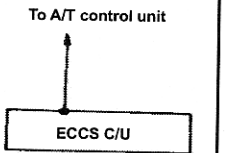
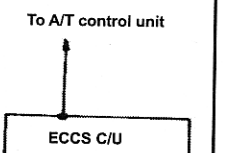
Terminal No.	Signal name	Circuit	At idle		At approx. 2,500 rpm	
			Standard	Memo	Standard	Memo
28	Engine temperature sensor signal		Engine temperature 80°: Approx. 1V Engine temperature 20°: Approx. 3V		Engine temperature 80°: Approx. 1V Engine temperature 20°: Approx. 3V	
29	Exhaust gas sensor signal		Approx. 0 ~ 1V		Deflect between 0 ~ Approx. 1V	
32	Monitor & Check lamp (red lamp, exhaust temperature warning lamp)		Lamp not lit: Power voltage Lamp lit: 0V		Lamp not lit: Power voltage Lamp lit: 0V	
36	FICD solenoid		A/C ON: 0V A/C OFF: Power voltage		A/C ON: 0V A/C OFF: Power voltage	
38	Throttle sensor signal		Approx. 0.5V		0.5 ~ 4V (Voltage increase when accelerator pedal is depressed)	
40	Intake air quantity output signal		Approx. 1V		Approx. 1.5V	

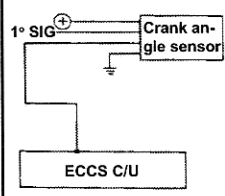
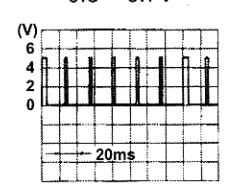
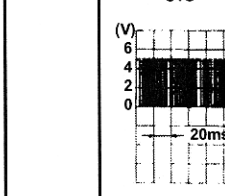
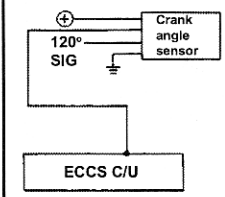
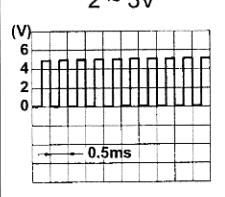
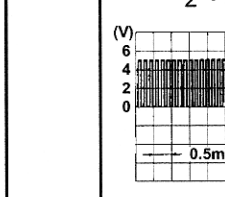
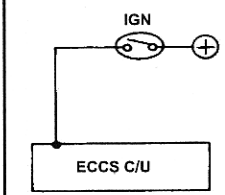
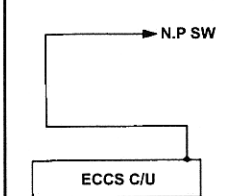
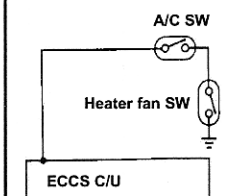
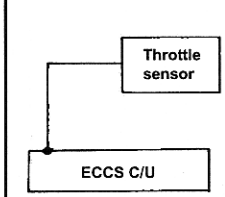
RB25DE / RB25DET ENGINE																																																																									
101	102	103	04	105	106	107	108	1	2	3	4	5	6	7	8	9	10		21	22	23	24	25	26	27	28	29	30	41	42	43	44	45	46	47	48	49	50																																			
109	110	111	112	113	114	115	116	11	12	13	14	15	16	17	18	19	20		31	32	33	34	35	36	37	38	39	40	51	52	53	54	55	56	57	58	59	60																																			
<table border="1"> <tr> <td>RX</td><td>TX</td><td></td><td></td><td></td><td>CHK</td><td>IGN</td> </tr> <tr> <td>-</td><td>CLK</td><td></td><td></td><td></td><td></td><td></td> </tr> </table>		RX	TX				CHK	IGN	-	CLK																																																															
RX	TX				CHK	IGN																																																																			
-	CLK																																																																								
Terminal No.	Signal name	Circuit	At idle		At approx. 2,500 rpm																																																																				
			Standard	Memo	Standard	Memo																																																																			
41	Crank angle sensor 120° signal		0.3 ~ 0.7V		0.3 ~ 0.7V																																																																				
																																																																									
42	Crank angle sensor 1° signal		2 ~ 3V		2 ~ 3V																																																																				
																																																																									
43	Ignition switch (START signal)		0V (Ignition switch START: Power voltage)		0V																																																																				
44	Neutral switch signal		N or P range: 0V Other than N or P range: 4 ~ 5V		N or P range: 0V Other than N or P range: 4 ~ 5V																																																																				
46	Air conditioner switch signal		Air conditioner OFF: Power voltage Air conditioner ON: 0V		Air conditioner OFF: Power voltage Air conditioner ON: 0V																																																																				
48	Intake air quantity output signal		5V		5V																																																																				

RB25DE / RB25DET ENGINE

101	102	103	04	105	106	107	108	1	2	3	4	5	6	7	8	9	10		21	22	23	24	25	26	27	28	29	30	41	42	43	44	45	46	47	48	49	50
109	110	111	112	113	114	115	116	11	12	13	14	15	16	17	18	19	20		31	32	33	34	35	36	37	38	39	40	51	52	53	54	55	56	57	58	59	60

RX	TX				CHK	IGN
-	CLK					

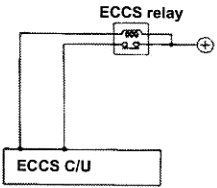
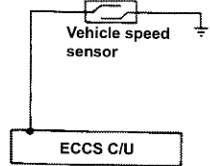
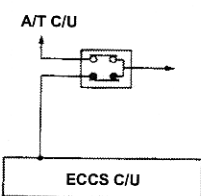
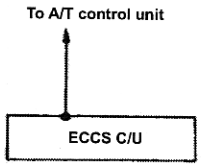
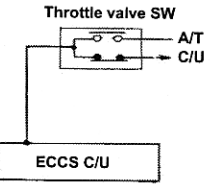
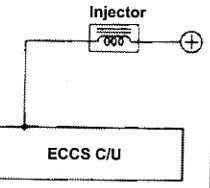
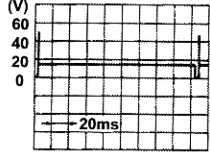
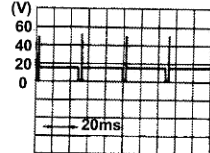
Terminal No.	Signal name	Circuit	At idle		At approx. 2,500 rpm		
			Standard	Memo	Standard	Memo	
49	ECCS C/U power supply		Power voltage		Power voltage		
53	Vehicle speed sensor signal		D range (or 1st) with rear wheels jacked up: 0.5 ~ 1.5V The value actually deflects between 0 and 5V. However, it appears to deflect around 1V according to vehicle speed.		D range (or 1st) with rear wheels jacked up: 0.5 ~ 1.5V The value actually deflects between 0 and 5V. However, it appears to deflect around 1V according to vehicle speed.		
54	Throttle valve switch (Idle contact point)		Approx. 10V		0V when accelerator pedal is depressed		
56	Throttle opening output signal		Approx. 0.5V		Approx. 0.5 ~ 4V (Voltage will increase when accelerator pedal is depressed)		
57	Throttle valve switch (power supply)		Power voltage		Power voltage		
101 103 105 110 112 114	Injector control signal		Almost power voltage			Almost power voltage	

ENGINE MECHANICAL SERVICE DATA

1. COMPRESSION PRESSURE MPa {kg/cm²} / (300rpm)

	RB20E	RB25DE	RB25DET	RB26DETT
Standard value	1.23 {12.5}	1.26 {12.8}	1.20 {12.2}	1.18 {12.0}
Limit	0.93 {9.5}	0.96 {9.8}	0.90 {9.2}	0.88 {9.0}
Difference limit between each cylinder	0.10 {1.0}	0.10 {1.0}	0.10 {1.0}	0.10 {1.0}

2. AUXILIARY BELT DEFLECTION

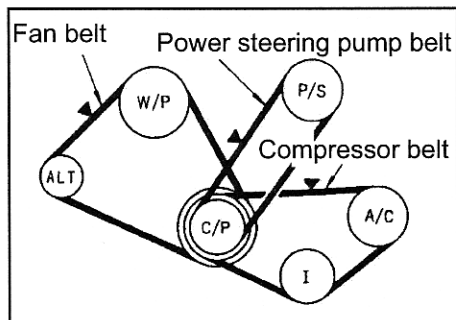

Tension gauge is used
(RB20E, RB25DE, RB25DET) (N {kg})

	New	Adjusted	Readjustment limit
Standard power steering pump belt	490~578 {50~59}	382~470 {39~48}	225 {23}
Air compressor belt	666~755 {68~77}	558~647 {57~66}	284 {29}
Fan belt	666~755 {68~77}	558~657 {57~66}	284 {29}

(RB26DETT) (N {kg})

	New	Adjusted	Readjustment limit
Standard power steering pump belt	670~760 {68~77}	550~640 {56~65}	280 {29}
Air compressor belt	670~760 {68~77}	550~640 {56~65}	280 {29}
Fan belt	670~760 {68~77}	550~640 {56~65}	280 {29}

Pushed with 98N {10kg}
(RB20E, 25DE, 25DETT) (mm)

	New	Adjusted	Readjustment limit
Standard power steering pump belt	8 ~ 10	9 ~ 11	15
Air compressor belt	6 ~ 8	7 ~ 9	12
Fan belt	3 ~ 5	4 ~ 6	7.5

(RB26DETT) (mm)

	New	Adjusted	Readjustment limit
Standard power steering pump belt	8 ~ 11	10 ~ 12	16
Air compressor belt	6 ~ 8	7 ~ 9	12
Fan belt	3 ~ 5	4 ~ 6	7.5

Intake & exhaust (mm)

	RB20E, RB25DE, RB25DET	RB26DETT
Intake manifold distortion limit value	0.1	0.15
Intake manifold collector distortion limit	0.1	0.1
Exhaust manifold distortion limit value	0.3	0.3

Turbo charger**(RB25DET) (mm)**

Swing injection-valve opening pressure (kPa {mmHg})	49 ~ 54 {365 ~ 405} (M / T)
Actuator rod is stroking 0.38mm away from fully open position	33 ~ 39 {250 ~ 290} (A / T)
Rotor shaft end play (mm)	0.120 ~ 0.200

(RB26DETT) (mm)

Actuator rod working pressure (kPa {mmHg})	Stroking 0.38mm	59 ~ 64 {440 ~ 480}
	Stroking 4.00 mm	78 ~ 84 {587 ~ 627}
Rotor shaft end play (mm)		0.013 ~ 0.097

3. CAM SHAFT (mm)

		RB20E	RB25DE	RB25DET	RB26DETT
Cam shaft deflection limit value		0.01	0.05	0.05	0.05
Cam nose height standard value	Intake	39.242 ~ 39.432	39.705 ~ 39.895		40.58
	Exhaust	39.123 ~ 39.313	39.705 ~ 39.895		40.28
Cam shaft oil clearance standard value	No. 1 ~ 6 journal	0.014 ~ 0.090	0.045 ~ 0.086		0.045 ~ 0.086
	No. 7 journal	0.065 ~ 0.110	0.016 ~ 0.101		
Cam shaft end play standard value		0.030 ~ 0.060	0.060 ~ 0.110		0.030 ~ 0.080
Valve lifter clearance standard value		0.043 ~ 0.066	0.035 ~ 0.065		0.035 ~ 0.065
Hydraulic valve lifter subduction limit		1.0			-

4. ROCKER SHAFT (RB20E) (mm)

Rocker arm oil clearance standard value	0.007 ~ 0.049
---	---------------

5. CYLINDER HEAD (mm)

DIAG (A)

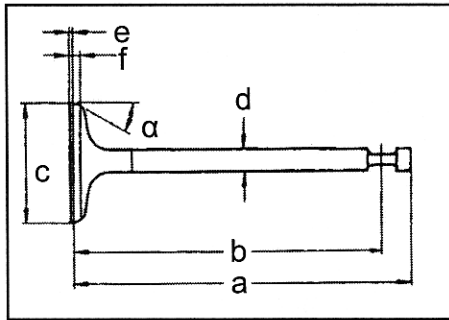

		RB20E	RB25DE	RB25DET	RB26DETT
Cylinder head distortion limit		0.2	0.2	0.2	0.2
Valve measurement standard value (refer to Diag A)	Intake				
	a	126.8	85.3 ~ 85.5	85.3 ~ 85.5	100.88 ~ 101.08
	b	-	80.78 ~ 81.08	80.78 ~ 81.08	97.3 ~ 97.6
	c	38.0 ~ 38.2	34.0 ~ 34.02	34.0 ~ 34.02	34.5 ~ 34.7
	d	6.965 ~ 6.980	5.965 ~ 5.980	5.965 ~ 5.980	5.965 ~ 5.980
	e	1.15 ~ 1.45	1.15 ~ 1.45	1.15 ~ 1.45	1.3
	f	2.4 ~ 2.8	2.6 ~ 2.9	2.6 ~ 2.9	2.6 ~ 2.9
	α	45° 15' ~ 45° 45'	45° 15' ~ 45° 45'	45° 15' ~ 45° 45'	45° 30'
Exhaust					
a	126.0	87.3 ~ 87.5	87.3 ~ 87.5	99.88 ~ 100.08	
b	-	82.78 ~ 83.08	82.78 ~ 83.08	95.33 ~ 95.63	
c	33.0 ~ 33.2	29.00 ~ 29.07	29.00 ~ 29.07	30.0 ~ 30.2	
d	6.965 ~ 7.970	5.945 ~ 5.960	5.945 ~ 5.960	6.905 ~ 6.920	
e	1.35 ~ 1.65	1.35 ~ 1.65	1.35 ~ 1.65	1.2	
f	3.0 ~ 3.7	3.2 ~ 3.4	3.2 ~ 3.4	2.9 ~ 3.2	
α	45° 15' ~ 45° 45'	45° 15' ~ 45° 45'	45° 15' ~ 45° 45'	45° 15' ~ 45° 45'	
Valve guide clearance limit		0.1	0.1	0.1	0.1
Valve guide boring measure standard value (using OS)	Intake	Φ11.175 ~ 11.196	Φ10.185 ~ 10.196		Φ10.460 ~ 10.478
	Exhaust	Φ12.175 ~ 12.196			Φ11.460 ~ 11.478
Valve guide inside diameter measure (using OS)	Intake	Φ7.000 ~ 7.018	Φ6.000 ~ 6.018		Φ6.000 ~ 6.018
	Exhaust	Φ8.000 ~ 8.011			Φ7.000 ~ 7.018

DIAG (B) RB26DETT

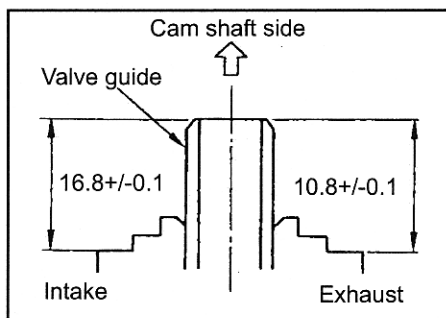

DIAG (B) RB20E / RB25DE / RB25DET

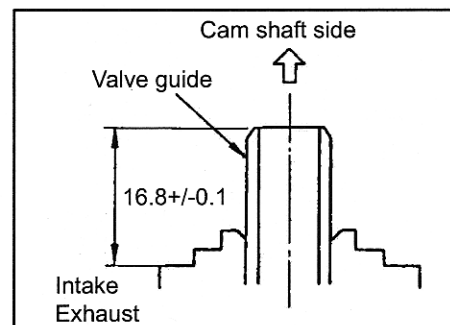

		RB20E	RB25DE / DET	RB26DETT
Valve guide installation height standard value (refer to diag B)		13.3	16.7 ~ 16.9	Refer to diag B
Valve seat boring measure standard value (using OS)	Intake	Φ40.500 ~ 40.516	Φ36.500 ~ 36.516	Φ36.500 ~ 36.516
	Exhaust	Φ35.500 ~ 35.516	32.000 ~ 32.016Φ	Φ32.500 ~ 32.516

RB20E

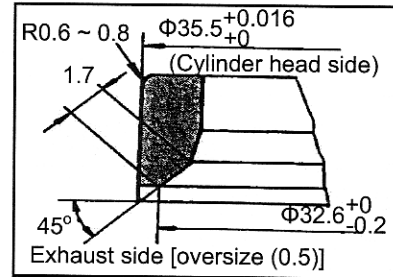
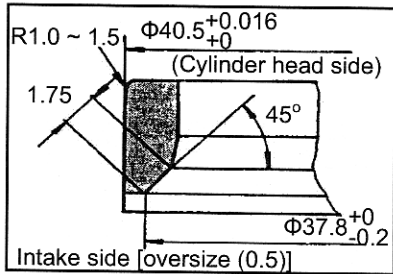

RB25DE / RB25DET

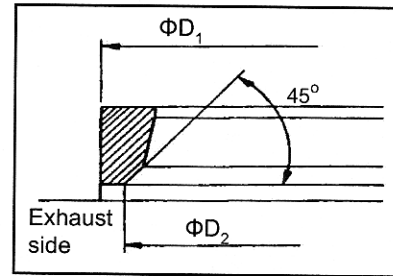
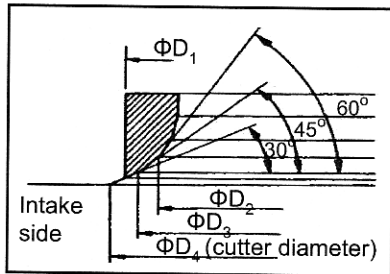

RB26DETT

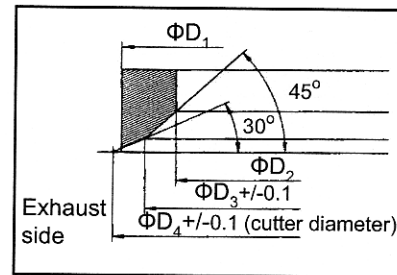
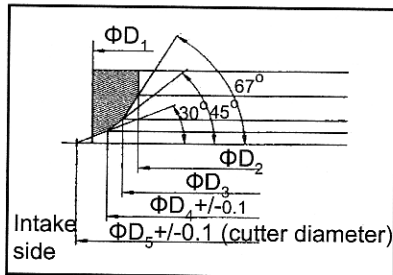

(mm)

		RB20E	RB25DE / RB25DET	RB26DETT
Valve seat measure standard value (using OS)	Intake	ΦD1	36.403 ~ 36.613	36.597 ~ 36.613
		ΦD2	32.0	29.85 ~ 30.15
		ΦD3	33.6 ~ 33.8	32.0
		ΦD4	37.0	34.3
		ΦD5	-	37.5
	Exhaust	ΦD1	31.920 ~ 32.096	32.580 ~ 32.596
		ΦD2	28.9 ~ 29.1	24.85 ~ 25.15
		ΦD4	-	32.5

RB20E

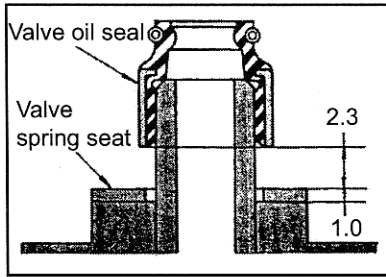

RB25DE / RB25DET

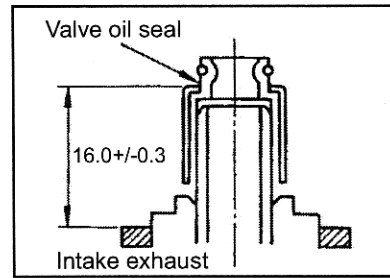

(mm)

	RB20E	RB25DE	RB25DET
Valve oil seal installation height standard value	Refer to above diagram		
Valve spring angularity limit (Inner) (Outer)	1.9 2.2	1.8	
Valve spring free length standard value (Inner) (Outer)	44.1 51.2	45.58 (EX) 39.4 (IN)	45.58 (EX) 39.4 (IN)
Valve face correction limit (Intake) (Exhaust)	Below 0.5 Below 0.5	- -	- -
Valve stem end correction limit (Intake) (Exhaust)	Below 0.2 Below 0.2	- -	- -
Valve spring compressive load standard value (Inner) (Outer)	108 {11.0} 250 {25.5}	270 ~ 287 {27.5 ~ 29.2} (EX) 223 ~ 252 {22.7 ~ 25.7} (IN)	270 ~ 287 {27.5 ~ 29.2} (EX) 223 ~ 252 {22.7 ~ 25.7} (IN)
Valve spring compression length standard value (Inner) (Outer)	35.0 40.0	35.0 (EX) 30.8 (IN)	35.0 (EX) 30.8 (IN)

RB26DETT

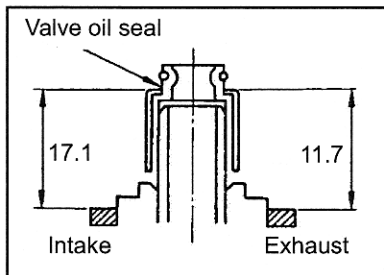

(mm)

	RB26DETT
Valve oil seal installation height standard value	Refer to above diagram
Valve spring angularity limit value	1.8
Valve spring free length standard value	46.54
Valve spring compressive load standard value (N{kg})	240 {24.0}
Valve spring compression length standard value	35.0

6. CYLINDER BLOCK

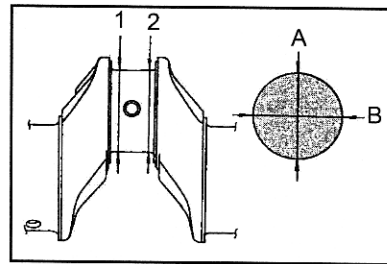
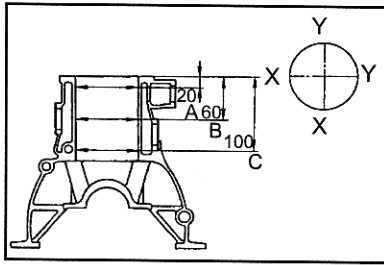

Degree of taper: 1 - 2 Elliptic degree: A-B

(mm)

		RB20E	RB25DE / RB25DET	RB26DETT
Cylinder block top surface flatness limit		0.1		
Cylinder bore diameter standard value		Φ77.950 ~ 78.000	Φ86.000 ~ 86.030	Φ86.000 ~ 86.030
Cylinder bore wear limit		0.2		
Cylinder bore out of round limit (X-Y)		0.015		
Cylinder bore taper limit (A-C)		0.010		
Piston and cylinder bore clearance standard		0.025 ~ 0.045	0.015 ~ 0.035	0.035 ~ 0.055
Main bearing housing inner diameter standard		Φ58.645 ~ 58.672		Φ58.645 ~ 58.670
Piston and piston pin clearance standard		-0.004 (retract) ~ 0		
Piston ring side clearance	Standard value (top ring)	0.040 ~ 0.073		
	(second ring)	0.030 ~ 0.063		
	(oil ring)	0.065 ~ 0.135		
	Limit value (top ring)	0.1		
	(second ring)	0.1		
	Standard value (top ring)	0.22 ~ 0.45	0.21 ~ 0.38	0.24 ~ 0.34
Piston ring alignment gap	(second ring)	0.19 ~ 0.45	0.18 ~ 0.44	0.42 ~ 0.57
	(oil ring)	0.20 ~ 0.76	0.20 ~ 0.76	0.20 ~ 0.60
	Limit value	0.1	0.1	-
Conrod side clearance (standard)		0.2 ~ 0.3		
(limit)		0.4		
Conrod bend limit (per 100mm)		0.1		0.15
Conrod torsion limit (per 100mm)		0.3		0.3
Conrod big end inner diameter standard		Φ45.000 ~ 45.013	Φ51.000 ~ 51.013	
Conrod bush oil clearance (small end) standard		0.005 ~ 0.017		
Crankshaft side clearance (standard)		0.05 ~ 0.18		
(limit)		0.3		
Crankshaft journal diameter standard		Φ54.951 ~ 54.975		
Crankshaft pin outer diameter standard		Φ41.961 ~ 41.974	Φ47.961 ~ 47.974	
Crankshaft out of round limit value		0.005		
Crankshaft taper limit value		0.005		
Crankshaft bend limit value		0.05		
Main bearing oil clearance (standard)		0.020 ~ 0.047		0.028 ~ 0.047
(limit)		0.090		0.090
Conrod bearing oil clearance (standard)		0.011 ~ 0.035	0.020 ~ 0.040	
(limit)		0.090	0.090	

7. PISTON SELECTION

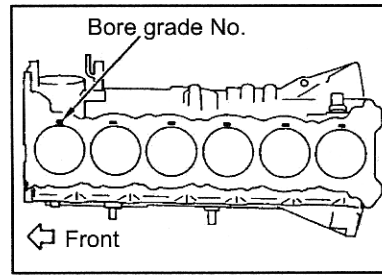
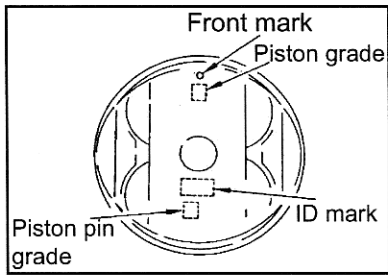

RB20E (mm)

Grade No.		1	2	3	4	5
Cylinder bore inner diameter		<u>77.960</u> 77.950	<u>77.970</u> 77.960	<u>77.980</u> 77.970	<u>77.990</u> 77.980	<u>78.000</u> 77.990
Piston	Outer diameter	<u>77.952</u> 77.915	<u>77.935</u> 77.925	<u>77.945</u> 77.935	<u>77.955</u> 77.945	<u>77.965</u> 77.955
	Pin grade	0 I	0 I	0 I	0 I	0 I
Piston clearance		0.025 ~ 0.045				
		Service setting: STD 1, 2, 3, 4, 5 OS (0.5), (1.0)				

RB25DE / RB25DET

Grade No.		1	2	3
Cylinder bore inner diameter		<u>86.010</u> 86.000	<u>86.020</u> 86.010	<u>86.030</u> 86.020
Piston	Outer diameter	<u>85.985</u> 85.975	<u>85.995</u> 85.985	<u>86.005</u> 85.995
	Pin grade	0 I	0 I	0 I
Piston clearance		0.015 ~ 0.035		
		Service setting: STD 1, 2, 3, 4, 5 OS (0.5), (1.0)		

RB26DETT

Grade No.		1	2	3
Cylinder bore inner diameter		<u>86.010</u> 86.000	<u>86.020</u> 86.010	<u>86.030</u> 86.020
Piston	Outer diameter	<u>85.965</u> 85.955	<u>85.975</u> 85.965	<u>85.985</u> 85.975
	Pin grade	0 I	0 I	0 I
Piston clearance		0.035 ~ 0.055		
		Service setting: STD1, 2, 3, OS (0.5), (1.0)		

8. PISTON PIN SELECTION

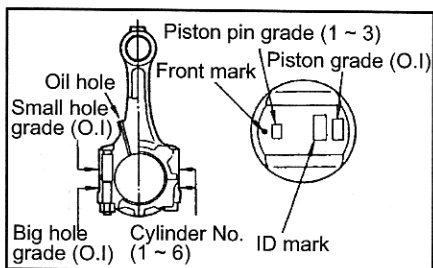

RB20E (mm)

Grade No.	O	I
Piston pin outer diameter	<u>18.995</u>	<u>19.001</u>
	18.989	20.995
Conrod small end inside diameter	<u>19.006</u>	<u>19.012</u>
	19.000	19.006
Piston pin diameter	<u>18.993</u>	<u>18.999</u>
	18.987	18.993
Piston pin ~ bush clearance	0.005 ~ 0.017	0.005 ~ 0.017
Piston pin ~ pin hole clearance	-0.004 ~ 0	-0.004 ~ 0

RB25DE / RB25DET / RB26DETT (mm)

Grade No.	O	I
Piston pin outer diameter	<u>20.995</u>	<u>21.001</u>
	20.989	20.995
Conrod small end inside diameter	<u>21.006</u>	<u>21.012</u>
	21.000	21.006
Piston pin diameter	<u>20.993</u>	<u>20.999</u>
	20.987	20.993
Piston pin ~ bush clearance	0.005 ~ 0.017	0.005 ~ 0.017
Piston pin ~ pin hole clearance	-0.004 ~ 0	-0.004 ~ 0

9. CONROD BEARING SELECTION

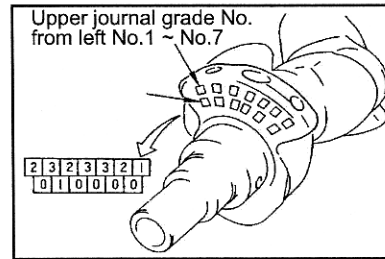
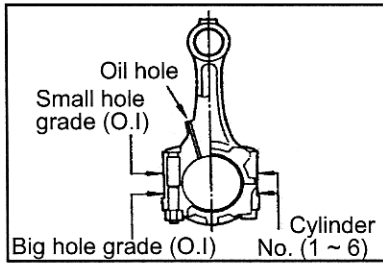

RB20E (mm)

Conrod large end inner diameter		$\Phi 45.077$ $\Phi 45.000$	$\Phi 45.013$ $\Phi 45.007$
Crank pin outer diameter	Grade No.	0	1
$\Phi 41.974$ $\Phi 41.968$	0	Bearing grade No. STD 0 Bearing thickness (mm) 1.502 ~ 1.506 Oil clearance (mm) 0.014 / 0.035 Grade colour None	Bearing grade No. STD 1 Bearing thickness (mm) 1.506 ~ 1.510 Oil clearance (mm) 0.013 / 0.033 Grade colour Brown
$\Phi 41.968$ $\Phi 41.961$	1	Bearing grade No. STD 1 Bearing thickness (mm) 1.506 ~ 1.510 Oil clearance (mm) 0.012 / 0.034 Grade colour Brown	Bearing grade No. STD 2 Bearing thickness (mm) 1.510 ~ 1.514 Oil clearance (mm) 0.011 / 0.032 Grade colour Green

Service setting: STD 0, 1, 2 US 0.08, 0.12, 0.25

RB25DE / RB25DET / RB26DETT (mm)

Conrod large end inner diameter		$\Phi 51.007$ $\Phi 51.000$	$\Phi 51.013$ $\Phi 51.007$
Crank pin outer diameter	Grade No.	0	1
$\Phi 47.974$ $\Phi 47.968$	0	Bearing grade No. STD 0 Bearing thickness (mm) 1.500 ~ 1.503 Oil clearance (mm) 0.020 / 0.039 Grade colour None	Bearing grade No. STD 1 Bearing thickness (mm) 1.503 ~ 1.506 Oil clearance (mm) 0.021 / 0.039 Grade colour Brown
$\Phi 47.968$ $\Phi 47.961$	1	Bearing grade No. STD 1 Bearing thickness (mm) 1.503 ~ 1.506 Oil clearance (mm) 0.020 / 0.040 Grade colour Brown	Bearing grade No. STD 2 Bearing thickness (mm) 1.506 ~ 1.509 Oil clearance (mm) 0.021 / 0.040 Grade colour Green

Service setting: STD 0, 1, 2 US 0.08, 0.12, 0.25

10. MAIN BEARING SELECTION

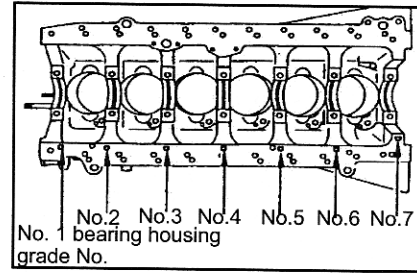
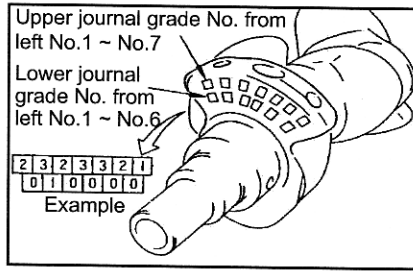

RB20E / RB25DE / RB25DET (mm)

Cylinder block bearing housing inner diameter			$\Phi 58.654$ $\Phi 58.645$	$\Phi 58.663$ $\Phi 58.654$	$\Phi 58.672$ $\Phi 58.663$
Crank journal diameter	Grade No.		0	1	2
$\Phi 54.975$ $\Phi 54.967$	0	Bearing grade No. Bearing thickness Oil clearance Grade colour	STD 0 1.825 / 1.821 0.020 / 0.045 Black	STD 1 1.829 / 1.825 0.021 / 0.046 Brown	STD 2 1.833 / 1.829 0.022 / 0.047 None
$\Phi 54.967$ $\Phi 54.959$	1	Bearing grade No. Bearing thickness Oil clearance Grade colour	STD 1 1.829 / 1.825 0.020 / 0.045 Brown	STD 2 1.833 / 1.829 0.021 / 0.046 None	STD 3 1.837 / 1.833 0.022 / 0.047 Yellow
$\Phi 54.959$ $\Phi 54.951$	2	Bearing grade No. Bearing thickness Oil clearance Grade colour	STD 2 1.833 / 1.829 0.020 / 0.045 None	STD 3 1.837 / 1.833 0.021 / 0.046 Yellow	STD 4 1.841 / 1.837 0.022 / 0.047 Blue

RB26DETT (mm)

Cylinder block bearing housing inner diameter			$\Phi 58.651$ $\Phi 58.645$	$\Phi 58.657$ $\Phi 58.651$	$\Phi 58.663$ $\Phi 58.657$	$\Phi 58.670$ $\Phi 58.663$
Crank journal diameter	Grade No.		0	1	2	3
$\Phi 54.975$ $\Phi 54.969$	0	Bearing grade No. Bearing thickness Oil clearance Grade colour	STD 0 1.818 / 1.821 0.028 / 0.046 Black	STD 1 1.821 / 1.824 0.028 / 0.046 Brown	STD 2 1.833 / 1.829 0.022 / 0.047 None	STD 3 1.827 / 1.830 0.028 / 0.047 Yellow
$\Phi 54.969$ $\Phi 54.963$	1	Bearing grade No. Bearing thickness Oil clearance Grade colour	STD 1 1.821 / 1.824 0.028 / 0.046 Brown	STD 2 1.824 / 1.827 0.028 / 0.046 None	STD 3 1.837 / 1.833 0.022 / 0.047 Yellow	STD 4 1.830 / 1.833 0.028 / 0.047 Blue
$\Phi 54.963$ $\Phi 54.957$	2	Bearing grade No. Bearing thickness Oil clearance Grade colour	STD 2 1.833 / 1.829 0.020 / 0.045 None	STD 3 1.827 / 1.830 0.028 / 0.046 Yellow	STD 4 1.841 / 1.837 0.022 / 0.047 Blue	STD 5 1.833 ~ 1.839 0.028 / 0.047 Green
$\Phi 54.957$ $\Phi 54.951$	3	Bearing grade No. Bearing thickness Oil clearance Grade colour	STD 3 1.827 / 1.830 0.028 / 0.046 Yellow	STD 4 1.830 / 1.833 0.028 / 0.046 Blue	STD 5 1.833 / 1.836 0.028 / 0.046 Green	STD 6 1.836 / 1.839 0.028 / 0.047 Pink

ENGINE LUBRICATION & COOLING**1. ENGINE OIL CAPACITY (L)**

ITEM		CAPACITY		
		RB20E / RB25DE	RB25DET	RB26DETT
H level		4.0	4.1	4.5
L level		3.0	3.3	3.5
Replacing oil only	Extracted from drain plug	Approx. 3.8	Approx. 3.9	Approx. 4.2
	Oil changer is used	Approx. 4.0	Approx. 4.1	-
Replacing oil & oil filter	Extracted from drain plug	Approx. 4.2	Approx. 4.3	Approx. 4.6
	Oil changer is used	Approx. 4.4	Approx. 4.5	-

2. COOLANT (L)

	RB20E / RB25DE / RB25DET	RB26DETT
Capacity	Approx. 8.5	Approx. 8.7

3. LLC CONCENTRATION (%)

	RB20E / RB25DE / RB25DET / RB26DETT
Standard	30
Cold climate area	50

4. RADIATOR CAP (MPa {kg/cm²})

	RB20E / RB25DE / RB25DET	RB26DETT
Radiator cap opening pressure	0.08 ~ 0.10 {0.8 ~ 1.0}	0.06 ~ 0.10 {0.6 ~ 1.0}

5. ENGINE OIL PRESSURE

Engine rev (rpm)		Idling	2000	6000
Exhaust pressure (KPa{kg/cm ² })	RB20E	Approx. 0.1 {1.0}	Approx. 0.37 {3.8}	Approx. 0.47 {4.8}
	RB25DE	Approx. 0.1 {1.0}	Approx. 0.32 {3.3}	Approx. 0.52 {5.3}
	RB25DET	Approx. 0.1 {1.0}	Approx. 0.34 {3.5}	Approx. 0.55 {5.6}
	RB26DETT	Approx. 0.15 {1.5}	Approx. 0.30 {3.0}	Approx. 0.46 {4.6}

VEHICLE SPECIFICATIONS

TYPE		E-HR33					
CLASSIFICATION NUMBER		010	032	048	056	060	064
CLASSIFICATION		SSEFECUA	SSEAECUA	SSEAELCUA	SKEFECA	SKEFECMA	SKEFECUA
VEHICLE TYPE		SEDAN			COUPE		
GRADE		GTS	GTS, GTS type G	GTS type G	GTS urban runner GTS ruban runner S		
LENGTH (mm)		4720			4640		
WIDTH (mm)		1720					
HEIGHT (mm)		1360			1340		
WHEEL BASE (mm)		2720					
TREAD (mm)	Front wheel	1480					
	Rear wheel	1470					
INTERIOR MEASUREMENT	Length	1895			1820		
	Width	1425			1415		
	Height	1115	1085		1090		
MOTOR TYPE		RB20					
TOTAL EMISSION (L)		1998					
FUEL TYPE		Gasoline					
VEHICLE WEIGHT (kg)	Front axle	720	740	750	710	710	720
	Rear axle	580	580	590	550	560	560
	Total	1300	1320	1340	1260	1270	1280
SEATING CAPACITY		5					
GROSS VEHICLE WEIGHT (kg)	Front axle	820	840	850	810	810	820
	Rear axle	755	755	765	725	735	735
	Total	1575	1595	1615	1535	1545	1555
MAX SAFE GRADIENT ANGLE (o)	Left	55					
	Right	55					
TYRE	Front	185/70R14 88S, 205/60R15 91H					
	Rear	185/70R14 88S, 205/60R15 91H					
MIN GROUND CLEARANCE (mm)		135					
SET MAX SPEED (km/h)		180					
FUEL CON-SUMPTION (km/l)	60 km/h	18.0	17.7		18.0		
	10.15 mode	11.4	10.2		11.8	11.4	
BRAKING DISTANCE (m) (Initial speed 50 km/h)		15.5					
MIN TURNING RADIUS (m)		5.2					
BRAKING DEVICE MAGNIFICATION RATE		8.6 (Pedal pressure of 22kg)			7.2 (20 kg)		8.6 (22 kg)
MAIN BRAKE (kg) / (pedal pressure kg)		846 (24) / 0.5			841 (25) / 0.5		846 (24) / 0.5
PARKING BRAKE (kg) / (pedal pressure kg)		345 (26) / 0.2					

VEHICLE SPECIFICATIONS

TYPE		E-HR33					
CLASSIFICATION NUMBER		010	032	048	056	060	064
CLASSIFICATION		SSEFECUA	SSEAECUA	SSEAELCUA	SKEFECA	SKEFECMA	SKEFECUA
VEHICLE TYPE		SEDAN			COUPE		
GRADE		GTS	GTS, GTS type G	GTS type G	GTS urban runner GTS ruban runner S		
LENGTH (mm)		4720			4640		
WIDTH (mm)		1720					
HEIGHT (mm)		1360			1340		
WHEEL BASE (mm)		2720					
TREAD (mm)	Front wheel	1480					
	Rear wheel	1470					
INTERIOR MEASUREMENT	Length	1895			1820		
	Width	1425			1415		
	Height	1115		1085		1090	
MOTOR TYPE		RB20					
TOTAL EMISSION (L)		1998					
FUEL TYPE		Gasoline					
VEHICLE WEIGHT (kg)	Front axle	720	740	750	710	710	720
	Rear axle	580	580	590	550	560	560
	Total	1300	1320	1340	1260	1270	1280
SEATING CAPACITY		5					
GROSS VEHICLE WEIGHT (kg)	Front axle	820	840	850	810	810	820
	Rear axle	755	755	765	725	735	735
	Total	1575	1595	1615	1535	1545	1555
MAX SAFE GRADIENT ANGLE (°)	Left	55					
	Right	55					
TYRE	Front	185/70R14 88S, 205/60R15 91H					
	Rear	185/70R14 88S, 205/60R15 91H					
MIN GROUND CLEARANCE (mm)		135					
SET MAX SPEED (km/h)		180					
FUEL CON-SUMPTION (km/l)	60 km/h	18.0	17.7		18.0		
	10.15 mode	11.4	10.2		11.8	11.4	
BRAKING DISTANCE (m) (Initial speed 50 km/h)		15.5					
MIN TURNING RADIUS (m)		5.2					
BRAKING DEVICE MAGNIFICATION RATE		8.6 (Pedal pressure of 22kg)			7.2 (20 kg)		8.6 (22 kg)
MAIN BRAKE (kg) / (pedal pressure kg)		846 (24) / 0.5			841 (25) / 0.5		846 (24) / 0.5
PARKING BRAKE (kg) / (pedal pressure kg)		345 (26) / 0.2					

SPECIFICATIONS

TYPE		E-HR33					
CLASSIFICATION NUMBER		092	096	100	104	108	112
CLASSIFICATION		SKEAECMA	SKEAECUA	SKEAECUMA	SKEAELCA	SKEAELCMA	SKEAELCUA
VEHICLE TYPE		COUPE					
GRADE		GTS urban runner GTS urban runner S			GTS urban runner S		
LENGTH (mm)		4640					
WIDTH (mm)		1720					
HEIGHT (mm)		1340					
WHEEL BASE (mm)		2720					
TREAD (mm)	Front wheel	1480					
	Rear wheel	1470					
INTERIOR MEASUREMENT	Length	1820					
	Width	1415					
	Height	1090			1060		
MOTOR TYPE		RB20					
TOTAL EMISSION (L)		1998					
FUEL TYPE		Gasoline					
VEHICLE WEIGHT (kg)	Front axle	730	740	740	740	740	750
	Rear axle	560	560	560	560	570	570
	Total	1290	1300	1300	1300	1310	1320
SEATING CAPACITY		5					
GROSS VEHICLE WEIGHT (kg)	Front axle	830	840	840	840	840	850
	Rear axle	735	735	735	735	745	745
	Total	1565	1575	1575	1575	1585	1595
MAX SAFE GRADIENT ANGLE (°)	Left	55					
	Right	55					
TYRE	Front	185/70R14 88S, 205/60R15 91H					
	Rear	185/70R14 88S, 205/60R15 91H					
MIN GROUND CLEARANCE (mm)		135					
SET MAX SPEED (km/h)		180					
FUEL CONSUMPTION (km/l)	60 km / h	17.7					
	10.15 mode	10.2					
BRAKING DISTANCE (m) (Initial speed 50 km/h)		15.5					
MIN TURNING RADIUS (m)		5.2					
BRAKING DEVICE MAGNIFICATION RATE		7.2 (20 kg)	8.6 (22 kg)		7.2 (20 kg)		8.6 (22 kg)
MAIN BRAKE (kg) / (pedal pressure kg)		841 (25) / 0.5	899 (26) / 0.5		841 (25) / 0.5		846 (24) / 0.5
PARKING BRAKE (kg) / (pedal pressure kg)		345 (26) / 0.2					

SPECIFICATIONS

TYPE		E-HR33	E-ER33				E-BCNR33
CLASSIFICATION NUMBER		116	134	138	142	145	003
CLASSIFICATION		SKEAELCUMA	SSGACCOA	SSGACC- OUA	SSGACLOA	SSGACLOUA	SKQFCCUMA
VEHICLE TYPE		COUPE	SEDAN				COUPE
GRADE		GTS urban runner S	GTS25t TYPE G				GT-R
LENGTH (mm)		4640	4720				4675
WIDTH (mm)		1720				1780	
HEIGHT (mm)		1340	1360				
WHEEL BASE (mm)		2720					
TREAD (mm)	Front	1480					
	Rear	1470	1470 / 1460			1490	
INTERIOR MEASURE- MENT	Length	1820	1895				1820
	Width	1415	1425				1415
	Height	1060	1115	1085		1090	
MOTOR TYPE		RB20	RB25				RB26
TOTAL EMISSION (L)		1998	2498				2568
FUEL TYPE		Gasoline					
VEHICLE WEIGHT (kg)	Front axle	750	800	810	810	820	880
	Rear axle	570	600	600	610	610	650
	Total	1320	1400	1410	1420	1430	1530
SEATING CAPACITY		5			6		4
GROSS VEHICLE WEIGHT (kg)	Front axle	850	900	910	910	920	965
	Rear axle	745	775	775	785	785	785
	Total	1595	1675	1685	1695	1705	1750
MAX SAFE GRADIENT ANGLE (o)	Left	55					
	Right	55					
TYRE	Front	185/70R14 86S, 205/ 60R15 91H	205 / 55R16 89V				225 / 45ZR17, 225 / 50R17 94V
	Rear		205 / 55R16 89V, 225 / 50R16 92V				
MIN GROUND CLEARANCE (mm)		135	145				
SET MAX SPEED (km/h)		180					
FUEL CON- SUMPTION (km/l)	60 km / h	17.7	16.2				14.4
	10.15 mode	10.2	8.9				8.1
BRAKING DISTANCE (m) (Initial speed 50 [*100] km/h)		15.5				50*	
MIN TURNING RADIUS (m)		5.2				5.7	
BRAKING DEVICE MAGNIFICATION RATE		8.6 (22 kg)				7.7 (30 kg)	
MAIN BRAKE (kg) / (pedal pressure kg)		846 (24) / 0.5	899 (26) / 0.5				1,200 (25) / 0.65
PARKING BRAKE (kg) / (pedal pressure kg)		345 (26) / 0.2				354 (25) / 0.2	

SPECIFICATIONS

TYPE		E-BCNR33			
CLASSIFICATION NUMBER		004	008	009	011
CLASSIFICATION		SKQFCCUMAZ	SKWFCCUMA	SKWFCCUMAZ	SKBFCUMAN
VEHICLE TYPE		COUPE			
GRADE		GT-R	GT-R V spec N1	GT-R V spec	GT-R V spec N1
LENGTH (mm)		4675			
WIDTH (mm)		1780			
HEIGHT (mm)		13602720			
WHEEL BASE (mm)		1480			
TREAD (mm)	Front				
	Rear	1490			
INTERIOR MEASUREMENT	Length	1820			
	Width	1415			
	Height	1090			
MOTOR TYPE		RB26			
TOTAL EMISSION (L)		2568			
FUEL TYPE		GASOLINE			
VEHICLE WEIGHT (kg)	Front axle	880	880	880	880
	Rear axle	660	660	670	660
	Total	1540	1540	1550	1640
SEATING CAPACITY		4			
GROSS VEHICLE WEIGHT (kg)	Front axle	965	965	965	965
	Rear axle	795	795	805	795
	Total	1760	1760	1770	1760
MAX SAFE GRADIENT ANGLE (°)	Left	55			
	Right	55			
TYRE	Front	225 / 45ZR17, 225 / 50R17 94V			
	Rear				
MIN GROUND CLEARANCE (mm)		145	135	145	135
SET MAX SPEED (km/h)		180			
FUEL CONSUMPTION (km/l)	60 km / h	14.4			
	10.15 mode	8.1			
BRAKING DISTANCE (m) (Initial speed 100 km/h)		50			
MIN TURNING RADIUS (m)		5.7			
BRAKING DEVICE MAGNIFICATION RATE		7.7 (30 kg)			
MAIN BRAKE (kg) / (pedal pressure kg)		1,200 (25) / 0.65			
PARKING BRAKE (kg) / (pedal pressure kg)		354 (25) / 0.2			

ENGINE SPECIFICATION

		RB20E	RB25DE	RB25DET	RB26DET		
					STD	N1	
DISPLACEMENT (l)		1,988	2,498	2,498	2,568		
COMBUSTION CHAMBER		Pent-roof type					
VALVE ARRANGEMENT		SOHC belt drive	DOHC belt drive				
BORE X STROKE		78.0 x 69.7	86.0 x 71.7		86.0 x 73.7		
COMPRESSION RATIO		9.5	10.0	9.0	8.5		
COMPRESSION PRESSURE [MPa{kg/cm ² } / rpm]		1.23{12.5}/300	1.26{12.8}/300	1.20{12.2}/300	1.18{12.0}/300		
MAX OUTPUT (net) [kw{PS} / rpm]		96{130}/5600	140{190}/6400 147{200}/6400	M/T 184{250}/6400 A/T 180{245}/6400	206{280}/6800		
MAX TORQUE (net) [N-m{kg-m} / rpm]		172{17.5}/4400	230{23.5}/4800	M/T 294{30.0}/4800 A/T 275{28.0}/4800	368{37.5}/4400		
FUEL CONSUMPTION RATIO [g/kw-h{g/PS-h} / rpm]		292{215}/2400	258{190}/3200	292{215}/2000	272{200}/2800		
DIMENSIONS (L x W x H) (mm)		M / T	845x590x655	2WD 845x595x680 4WD 845x595x690	845x630x680	870x656x675	
		A / T	830x590x655	2WD 830x696x680 4WD 830x696x690	830x630x680	830x630x680	
VALVE OPEN & CLOSE CY- CLE	Intake valve opening angle (°)	14	Early operation 20 Inactive operation 0	Early operation 20 Inactive operation 0	7		
	Intake valve closing angle (°)	50	Early operation 40 Inactive operation 60	Early operation 40 Inactive operation 60	53		
	Exhaust valve opening angle (°)	58	57	57	63	58	
	Exhaust valve closing angle (°)	10	3	3	7	2	
VALVE CLEARANCE	Intake (warm) (mm)	0 (Automatic adjustment)				0.51	
	Exhaust (warm) (mm)	0 (Automatic adjustment)				0.44	
IDLE SPEED (rpm)		M / T	600	650	650	950	
		A / T	650 (N range)	650 (N range)	650 (N range)	650 (N range)	
IGNITION TIMING (BTDC°/rpm)		M / T	20/600	15/650	15/650	20/950	
		A / T	20/650	15/650	15/650	15/650	
MAINTENANCE TARGET VALUE	Idle CO density (%)	Below 0.1					
	Idle HC density (ppm)	Below 50					
ENGINE OIL CAPACITY (OVER-HAUL) (L)		4.8	2WD 4.8 4WD 5.3	5.0	5.1	6.4	
OIL LEVEL GAUGE L~H DIFFERENCE (L)		1.0	1.0	0.8	1.0		
OIL FILTER CAPACITY (L)		0.4	0.4	0.4	0.4		
COOLANT CAPACITY (L)		8.5	8.5	8.5	9.0		

INDEX

Symbols

2-pole lift	GI-13
4WD Inspection	GI-17

A

A/T control system	
RB25DE / DET	EN-324
AAC valve system	
RB25DE / DET	EN-359, EN-365
RB26DETT	EN-376, EN-396
Abbreviation	GI-15
Accelerator control system	
RB25DE / DET	EN-142
RB26DETT	EN-239
Active test	EN-306
Air-cooled oil cooler	
RB26DETT	EN-231
Air cleaner & air duct	
RB20E	EN-67
RB25DE / DET	EN-103
RB26DETT	EN-158
Air conditioner cut control	
RB26DETT	EN-381
Air conditioner operation signal	
RB26DETT	EN-389
Air conditioner relay system	
RB25DE / DET	EN-354
Air flow meter system	
RB20E	EN-413
RB25DE / DET	EN-316, EN-363
RB26DETT	EN-330, EN-344
Air regulator	
RB25DE / DET	EN-360, EN-366
RB26DETT	EN-390, EN-396
Auxiliary belt deflection	SD-1
Auxiliary belt tension	EN-21
Auxiliary motor fan	
RB25DE / DET	EN-137
RB26DETT	EN-236

B

Back-up function	EN-299
------------------------	--------

Basic inspection

RB20E / RB26DETT	EN-307
RB25DE / DET	EN-309

Boost control

RB26DETT	EN-379, EN-396
----------------	----------------

Brake fluid

EN-25

Brake hose

EN-23

C

Cam shaft

RB20E	EN-83
RB25DE / DET	EN-122
RB26DETT	EN-193

Circuit diagram

RB20E	EN-263
RB25DE / DET	EN-265
RB26DETT	EN-267

Collector ASSY

RB20E	EN-92
-------------	-------

Component parts inspection

RB25DE / DET	EN-363
RB26DETT	EN-344, EN-394

Compression pressure

SD-1

Compression pressure inspection ...

EN-20

Connector symbol

GI-6

Conrod bearing selection

SD-9

Consult

EN-301, GI-11

Consult inspection values

RB20E	EN-436
RB25DE / DET	EN-444
RB26DETT	EN-428

Coolant

EN-65, SD-11

Cooling fan

RB20E	EN-97
RB25DE / DET	EN-136
RB26DETT	EN-235

Crank angle sensor system

RB20E	EN-410
RB25DE / DET	EN-314, EN-325,
RB26DETT	EN-328, EN-344

Cylinder block

SD-6

RB26DETT	EN-209
----------------	--------

Cylinder head

RB26DETT	EN-203
----------------	--------

- Cylinder head gasket
 RB20E..... EN-87
 RB25DE / DET EN-128
 RB26DETT..... EN-200
- D**
- Data monitor EN-303
 Detonation sensor system
 RB20E..... EN-426
 RB25DE / RB25DET EN-322
 RB26DETT..... EN-336
 Diagnosis items by phenomenon .. EN-275
 Diagnostic system EN-294
 Diagnostic worksheet EN-271
 Dropping resistor
 RB26DETT..... EN-395
 Dual mode muffler
 RB25DE / DET EN-146
- E**
- ECCS C/U input & output signals .. EN-428
 ECCS C/U pin layout
 RB20E..... EN-264
 RB25DE / DET EN-266
 RB26DETT..... EN-268
 ECCS relay
 RB26DETT..... EN-345
 Electronically concentrated engine control
 system EN-269
 Engine removal
 RB20E..... EN-250
 RB25DE / DET EN-254
 RB26DETT..... EN-259
 Engine lubrication & coolingSD-11
 Engine mechanical EN-67
 Engine mechanical service data SD-1
 Engine oil..... EN-63
 Engine oil capacitySD-11
 Engine oil pressure.....SD-11
 Engine specificationSP-6
 Engine temperature sensor system
 RB20E..... EN-422
 Exhaust gas sensor heater system
 RB25DE / DET EN-355
- Exhaust manifold
 RB20E..... EN-76
 RB25DE / DET EN-115
 RB26DETT..... EN-178
 Exhaust system
 RB25DE / DET EN-144
 RB26DETT..... EN-248
- F**
- Fail-safe function EN-299
 Fault diagnosis by self diagnosis
 system EN-312
 FICD solenoid
 RB25DE / DET EN-365
 Front disc brake
 RB25DE / DET EN-28
 Fuel injector
 RB20E..... EN-71
 RB25DE / DET EN-108
 RB26DETT..... EN-164
 Fuel pump
 RB26DETT..... EN-395
 Fuel pump & fuel gauge
 RB26DETT..... EN-245
 Fuel pump control modulator
 RB26DETT..... EN-395
 Fuel pump system control
 RB20E..... EN-398
 RB25DE / DET EN-346
 RB26DETT..... EN-367
 Fuel tank
 RB26DETT..... EN-240
 Function test..... EN-301
- G**
- Garage jackGI-14
 General precautionsGI-7
- H**
- How to use this manualGI-2

- I**
- Idle inspection EN-15
 - Idle mixture ratio EN-19
 - Idle speed control system
 - RB20E EN-408
 - Ignition coil
 - RB25DE / DET EN-364
 - RB26DETT EN-394
 - Ignition coil relay
 - RB26DETT EN-394
 - Ignition relay & Inhibitor relay
 - RB25DE / DET EN-366
 - Ignition signal
 - RB25DE / DET EN-348, EN-350
 - Ignition system
 - RB20E EN-404
 - RB25DE / DET EN-319
 - RB26DETT EN-334, EN-373
 - Ignition timing inspection EN-17
 - Injection pulse
 - RB26DETT EN-378
 - Injector
 - RB26DETT EN-395
 - Injector system inspection
 - RB20E EN-401
 - RB25DE / DET EN-351, EN-366
 - RB26DETT EN-370
 - Intake air temperature sensor system
 - RB26DETT EN-338, EN-345
 - Intake manifold
 - RB20E EN-73
 - RB25DE / DET EN-111
 - RB26DETT EN-174
 - Intake manifold collector
 - RB20E EN-68
 - RB25DE / DET EN-105
 - RB26DETT EN-166
 - Inter-cooler
 - RB25DET EN-148
 - RB26DETT EN-160
- M**
- Maintenance EN-15
 - Male & Female terminals GI-6
 - Master cylinder cap
 - RB20E, RB25DE / DET EN-26
 - RB26DETT EN-41
- N**
- Neutral signal
 - RB26DETT EN-388
- O**
- O2 sensor monitor EN-304
 - O2 sensor system
 - RB25DE / DET EN-321
 - RB26DETT EN-384, EN-395
 - Oil filter EN-64
 - Oil filter bracket & oil cooler
 - RB25DET EN-156
 - Oil filter bracket & water-cooled oil cooler
 - RB26DETT EN-228
 - Oil pan & oil filter
 - RB20E EN-90
 - RB25DE / DET EN-120
 - RB26DETT EN-190
 - Oil pump
 - RB20E EN-94
 - RB25DE / DET EN-131
 - RB26DETT EN-226
 - Operation support EN-306
 - Oscilloscope & circuit tester inspection
 - RB20E EN-438
 - RB25DE / DET EN-446
 - RB26DETT EN-430
- P**
- Phenomenon confirmation EN-272
 - Piston pin selection SD-8
 - Piston selection SD-7
 - Power steering hydraulic pressure inspection
 - RB25DE / DET EN-366
 - Power steering oil pressure signal
 - RB25DE / DET EN-362
 - RB26DETT EN-387, EN-397
 - Power supply and earth circuit
 - RB25DE / DET EN-312
 - RB26DETT EN-326
 - Power transistor
 - RB25DE / DET EN-364
 - RB26DETT EN-345

<p>R</p> <p>Radiator RB25DE / DET EN-134 RB26DETT EN-233 Radiator cap SD-11 Real-time diagnosis EN-305 Rear disc brake RB26DETT EN-42 Rigid rack support position GI-14 Rocker cover RB20E EN-78 RB25DE / DET EN-118 RB26DETT EN-188 Rocker shaft RB20E EN-79</p>	<p>S</p> <p>Self-diagnosis EN-296 Self-diagnosis mode EN-302 Service tools EN-8 Spark plug RB25DE / DET EN-43 RB26DETT EN-45 START signal RB25DE / DET EN-358 RB26DETT EN-386 Supplemental motor fan control RB26DETT EN-392, EN-396 System diagram RB20E EN-11 RB25DE EN-12 RB25DETT EN-14 RB26DETT EN-13 System outline EN-263</p>	<p>T</p> <p>Thermostat & water inlet RB20E EN-100 RB25DE / DET EN-140 Throttle sensor system RB20E EN-419 RB25DE / DET EN-323, EN-365 RB26DETT EN-340, EN-345</p>
<p>U</p> <p>Units conversion GI-16</p>	<p>V</p> <p>Valve clearance RB26DETT EN-198 Vehicle & unit identification plate GI-10 Vehicle specification SP-1 Vehicle speed sensor system RB20E EN-427 RB25DE / DET EN-353 RB26DETT EN-385</p>	<p>W</p> <p>Water outlet RB20E EN-102 Water pump RB20E EN-98 RB25DE / DET EN-138 RB26DETT EN-237 Water temperature sensor system RB25DE / DET EN-318, EN-363 RB26DETT EN-332, EN-397</p>