

Ground Points in Body <LHD H/B>

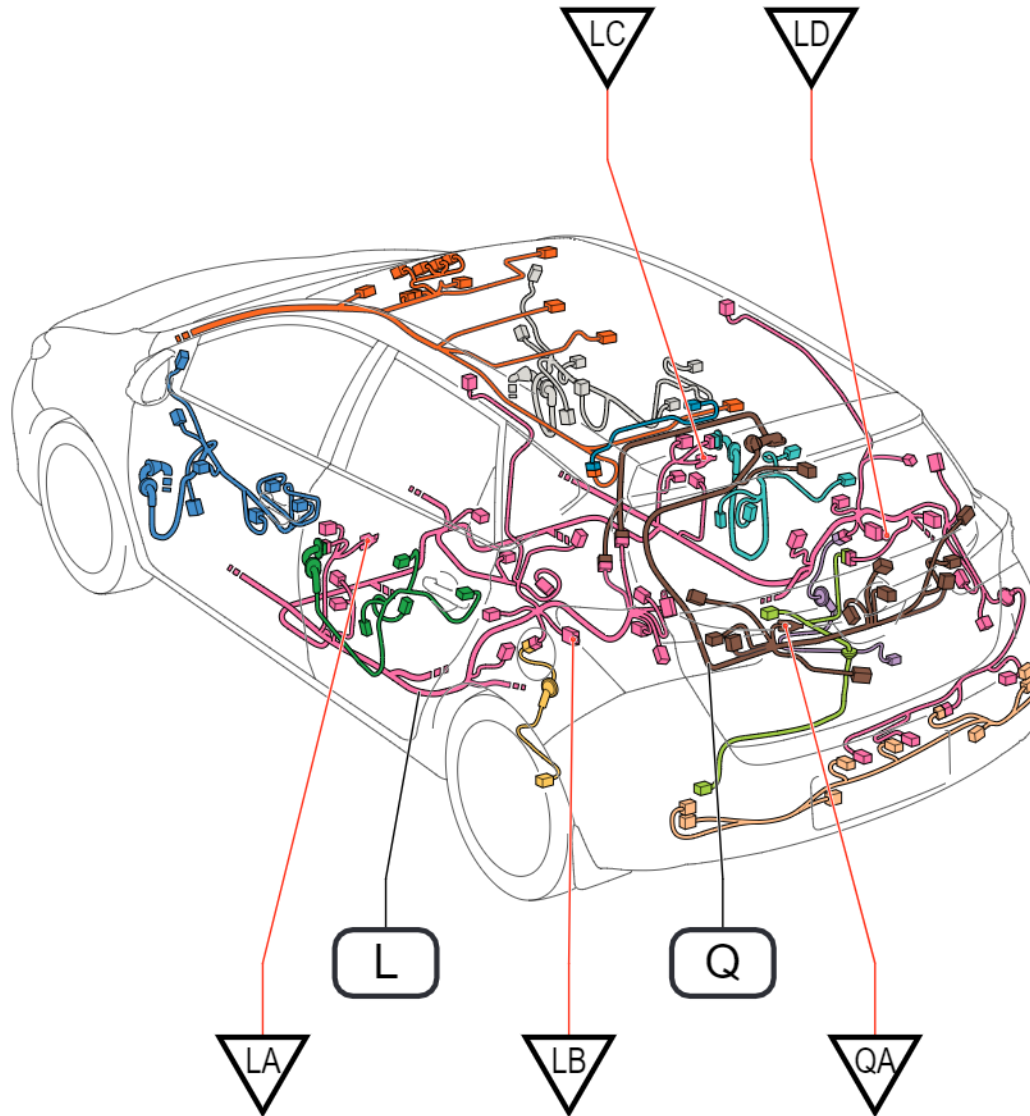

Position of Parts in Body <LHD H/B>

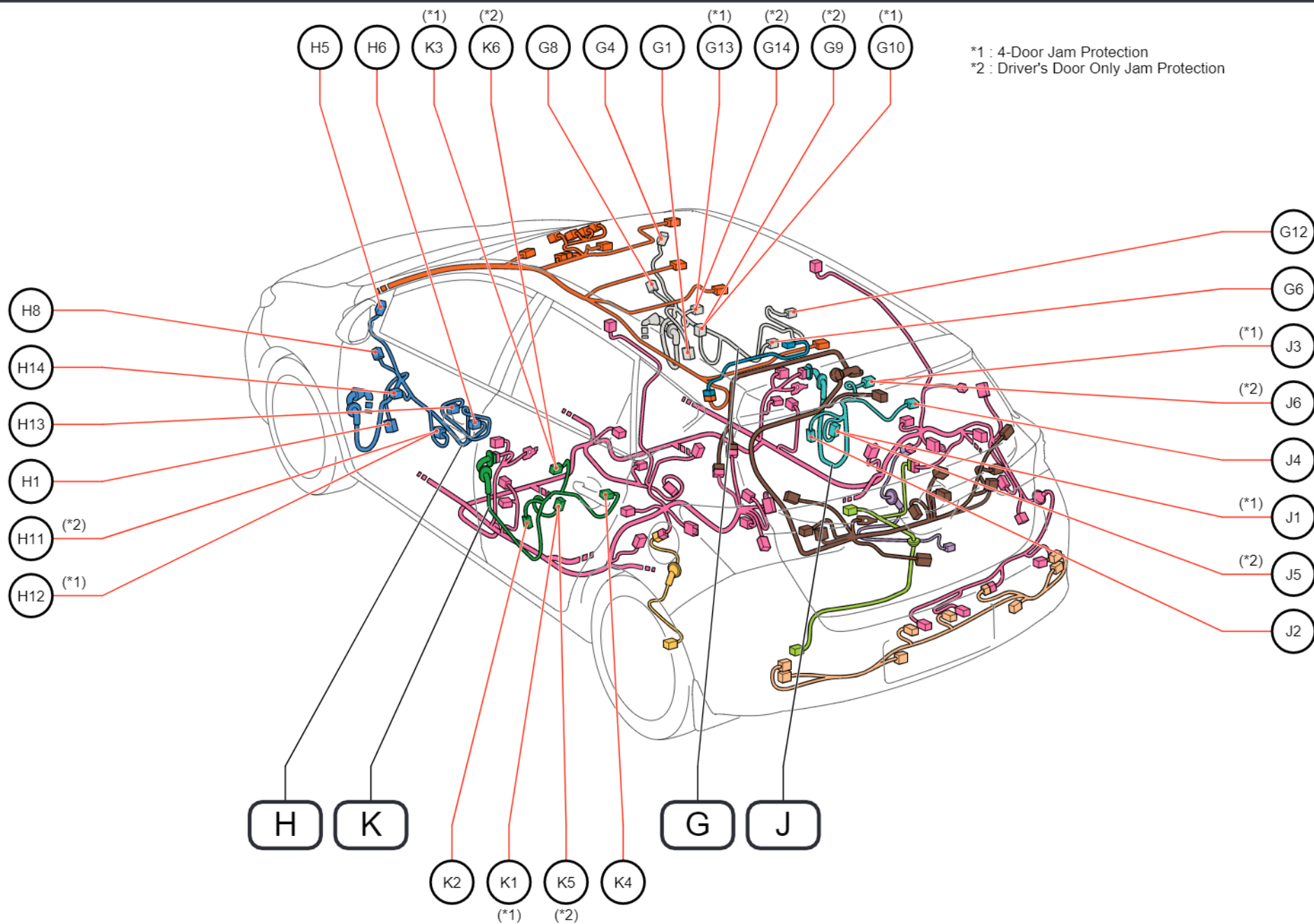

\*1 : 4-Door Jam Protection  
 \*2 : Driver's Door Only Jam Protection

Position of Parts in Body <LHD H/B>

---

- G 1 Front No. 1 Speaker Assembly RH
- G 4 Front No. 2 Speaker Assembly RH
- G 6 Front Door Lock Assembly RH
- G 8 Outer Rear View Mirror Assembly RH
- G 9 Front Power Window Regulator Switch Assembly RH
- G 10 Front Power Window Regulator Switch Assembly RH
- G 12 Front Door Outside Handle Assembly RH
- G 13 Front Power Window Regulator Motor Assembly RH
- G 14 Front Power Window Regulator Motor Assembly RH

- H 1 Front No. 1 Speaker Assembly LH
- H 5 Front No. 2 Speaker Assembly LH
- H 6 Front Door Lock Assembly LH
- H 8 Outer Rear View Mirror Assembly LH
- H 11 Power Window Regulator Master Switch Assembly
- H 12 Power Window Regulator Master Switch Assembly
- H 13 Front Door Outside Handle Assembly LH
- H 14 Front Power Window Regulator Motor Assembly LH

- J 1 Rear Power Window Regulator Switch Assembly RH
- J 2 Rear Speaker Assembly RH
- J 3 Rear Power Window Regulator Motor Assembly RH
- J 4 Rear Door Lock Assembly RH
- J 5 Rear Power Window Regulator Switch Assembly RH
- J 6 Rear Power Window Regulator Motor Assembly RH

- K 1 Rear Power Window Regulator Switch Assembly LH
- K 2 Rear Speaker Assembly LH
- K 3 Rear Power Window Regulator Motor Assembly LH
- K 4 Rear Door Lock Assembly LH
- K 5 Rear Power Window Regulator Switch Assembly LH
- K 6 Rear Power Window Regulator Motor Assembly LH

Position of Parts in Body <LHD H/B>

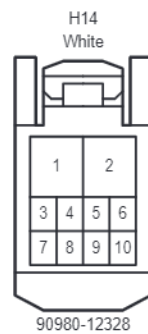
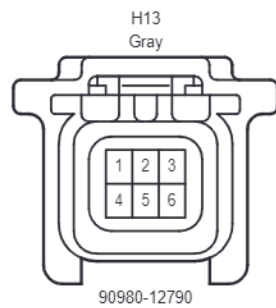
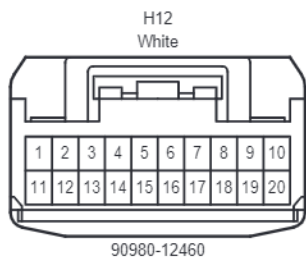
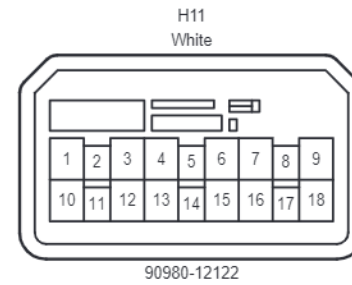
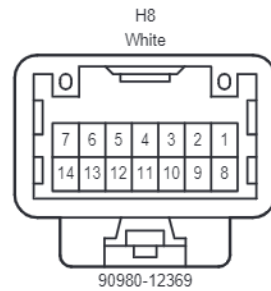
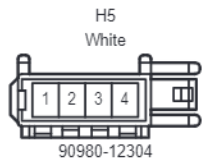
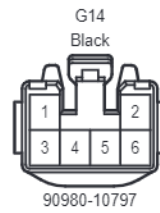
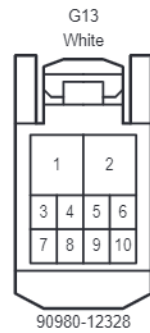
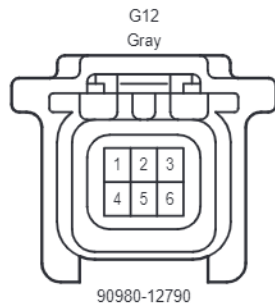
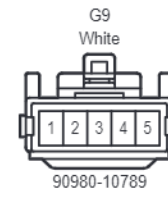
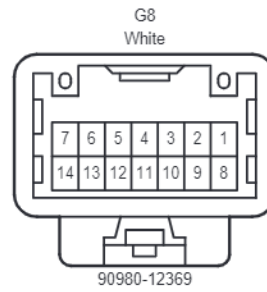
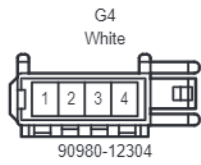

Position of Parts in Body <LHD H/B>

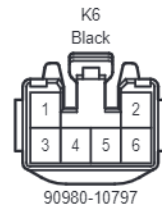
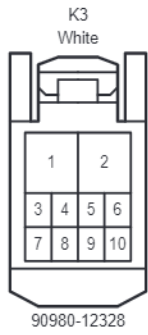
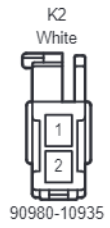

Position of Parts in Body <LHD H/B>

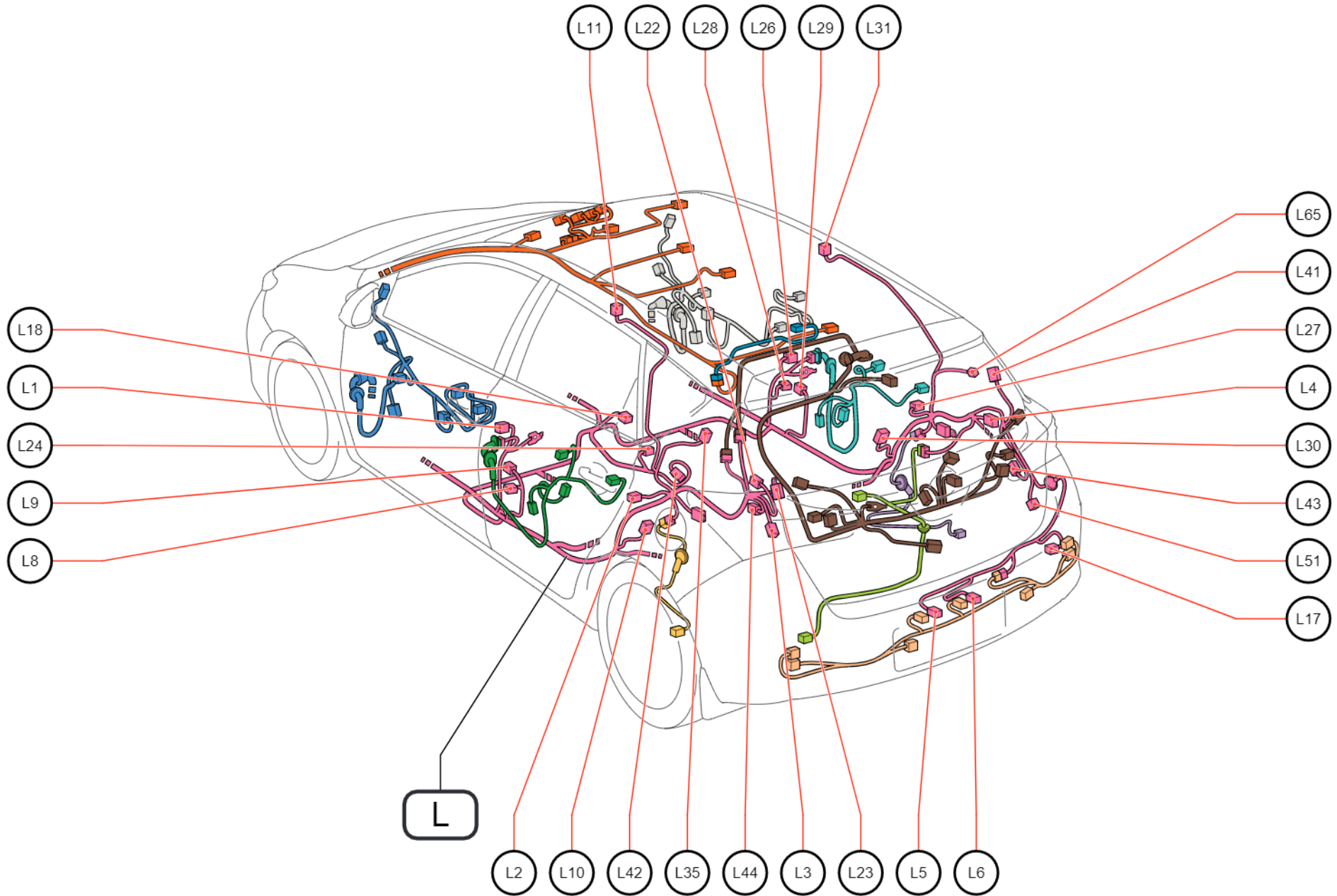



Position of Parts in Body <LHD H/B>

---

- L 1 Front Door Courtesy Light Switch Assembly LH
- L 2 Rear Door Courtesy Light Switch Assembly LH
- L 3 Rear Combination Light Assembly LH
- L 4 Rear Combination Light Assembly RH
- L 5 License Plate Light Assembly LH
- L 6 License Plate Light Assembly RH
- L 8 Front Seat Outer Belt Assembly LH
- L 9 Side Airbag Sensor Assembly LH
- L 10 Rear Side Airbag Sensor LH
- L 11 Curtain Shield Airbag Assembly LH
- L 17 Rear Electrical Key Antenna
- L 18 Parking Brake Switch Assembly
- L 22 No. 1 Luggage Compartment Light Assembly
- L 23 Noise Filter (Radio Setting Condenser)
- L 24 No. 3 Indoor Electrical Key Antenna Assembly
- L 26 Front Door Courtesy Light Switch Assembly RH
- L 27 Rear Door Courtesy Light Switch Assembly RH
- L 28 Front Seat Outer Belt Assembly RH
- L 29 Side Airbag Sensor Assembly RH
- L 30 Rear Side Airbag Sensor RH
- L 31 Curtain Shield Airbag Assembly RH
- L 35 Door Control Receiver
- L 41 No. 2 Clearance Warning Buzzer
- L 42 No. 2 Power Outlet Socket Assembly
- L 43 Rear No. 1 Power Outlet Socket Assembly
- L 44 No. 1 Speaker with Box Assembly
- L 51 Battery Thermometer Sensor
- L 65 Tire Pressure Monitor Receiver Assembly

Position of Parts in Body <LHD H/B>

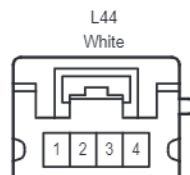
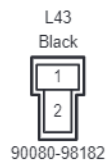
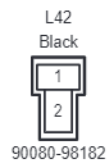
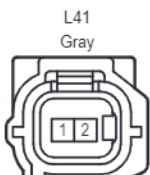
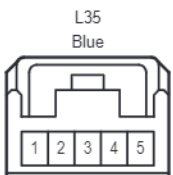
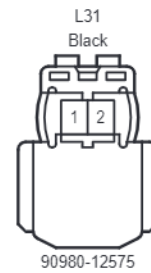
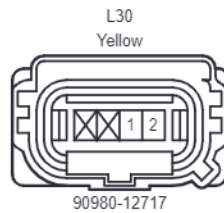
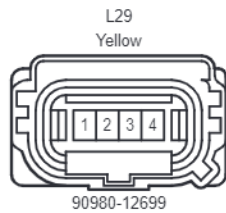
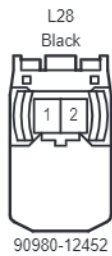
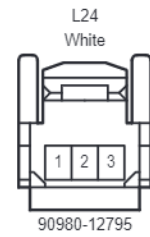
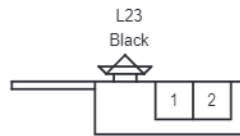
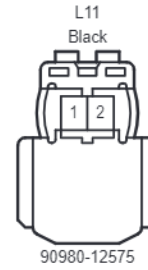
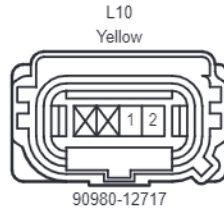
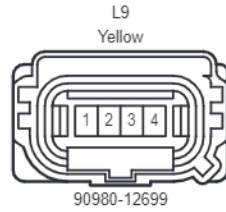
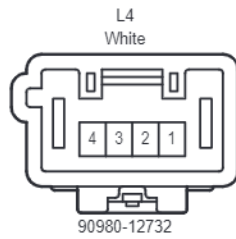
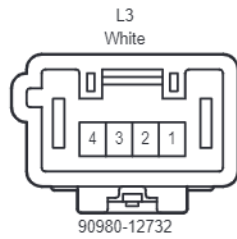

cardiagn.com

Position of Parts in Body <LHD H/B>

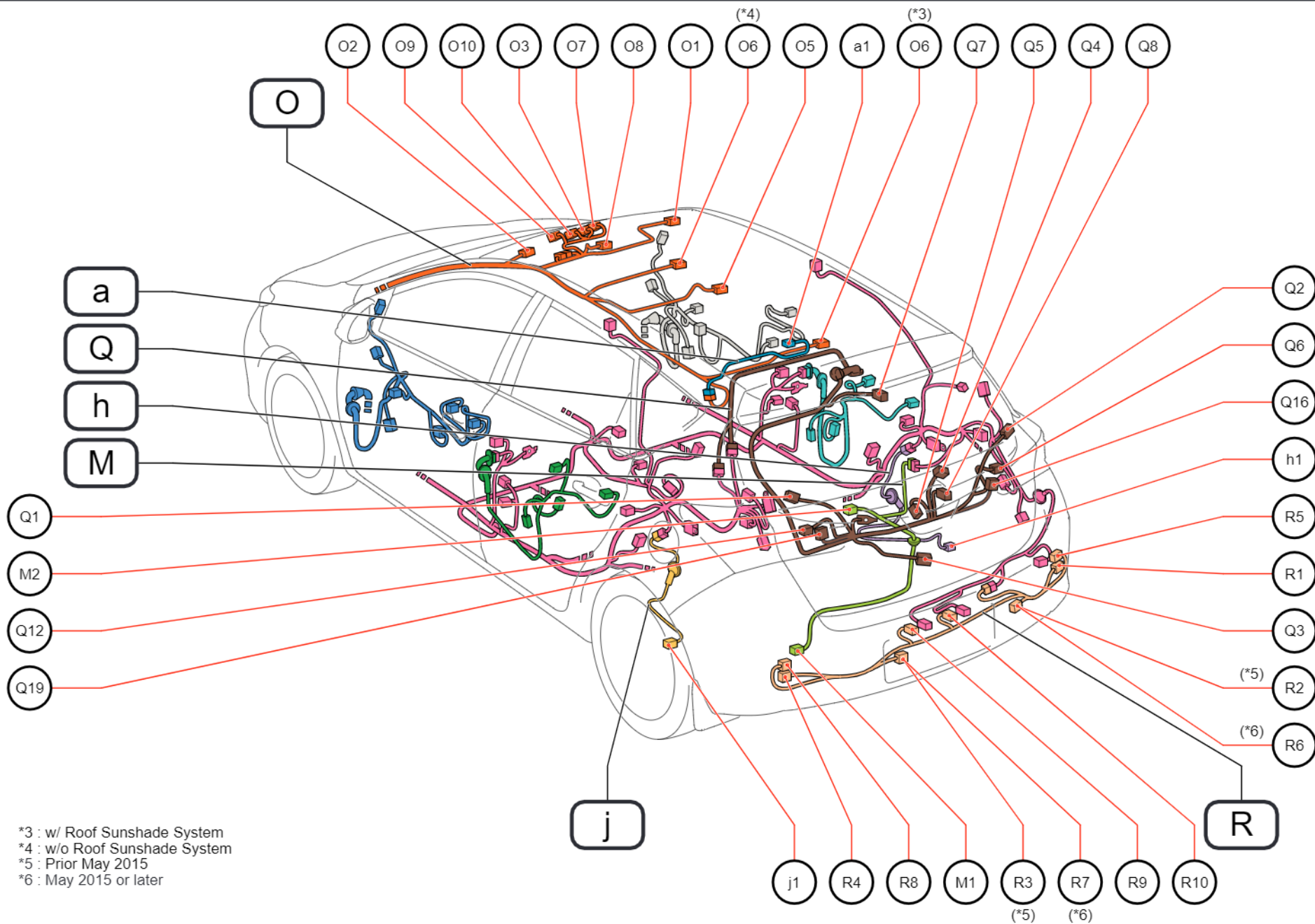

Position of Parts in Body <LHD H/B>

---

- M 1 Rear Height Control Sensor Sub-Assembly
- M 2 No. 1 Indoor Electrical Key Antenna Assembly

- O 1 Vanity Light Assembly RH
- O 2 Vanity Light Assembly LH
- O 3 Inner Rear View Mirror Assembly
- O 5 Rear Room Light (No. 1 Room Light Assembly)
- O 6 Dome Light (No. 1 Room Light Assembly)
- O 7 Rain Sensor
- O 8 Map Light Assembly
- O 9 Precrash Safety City Sensor
- O 10 Precrash Safety City Heater

- Q 1 Rear Window Defogger (Back Door Glass)
- Q 2 Rear Window Defogger (Back Door Glass)
- Q 3 Back Door Lock Assembly
- Q 4 Rear Wiper Motor Assembly
- Q 5 Rear Television Camera Assembly
- Q 6 Rear Light Assembly RH
- Q 7 Center Stop Light Assembly
- Q 8 Back Door Opener Switch Assembly
- Q 12 Rear Light Assembly LH
- Q 16 Rear Light Assembly RH
- Q 19 Rear Light Assembly LH

- R 1 Rear No. 1 Ultrasonic Sensor RH
- R 2 Rear No. 1 Ultrasonic Sensor Center RH
- R 3 Rear No. 1 Ultrasonic Sensor Center LH
- R 4 Rear No. 1 Ultrasonic Sensor LH
- R 5 Rear No. 1 Ultrasonic Sensor RH
- R 6 Rear No. 1 Ultrasonic Sensor Center RH
- R 7 Rear No. 1 Ultrasonic Sensor Center LH
- R 8 Rear No. 1 Ultrasonic Sensor LH
- R 9 License Plate Light Assembly LH
- R 10 License Plate Light Assembly RH

- a 1 Sliding Roof Drive Gear Assembly

- h 1 Rear Speed Sensor RH

- i 1 Rear Speed Sensor LH

Position of Parts in Body <LHD H/B>

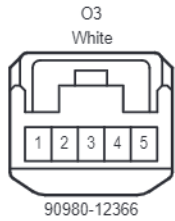
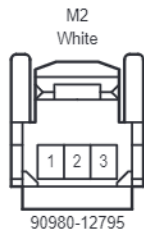

(Except November 2016 or later w/ Precrash System)

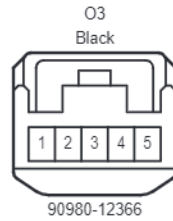

(November 2016 or later w/ Precrash System)

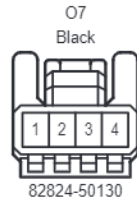
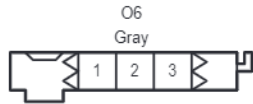

(Except November 2016 or later w/ Precrash System)

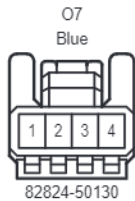

(November 2016 or later w/ Precrash System)

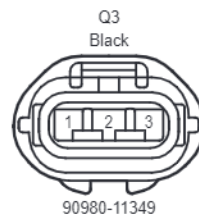
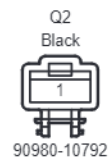
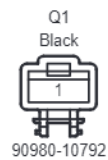
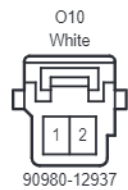
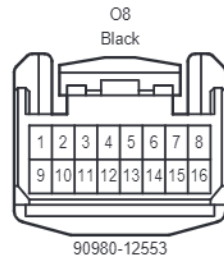

Position of Parts in Body <LHD H/B>

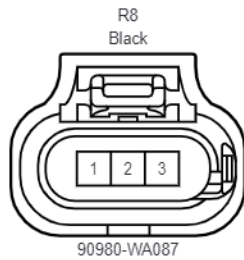
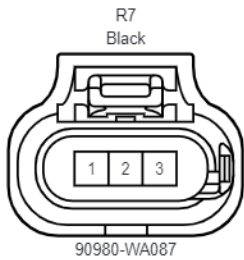
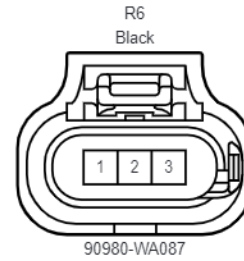
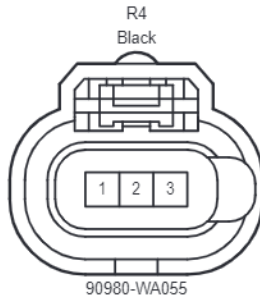
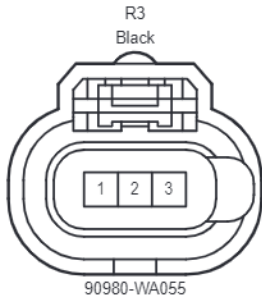
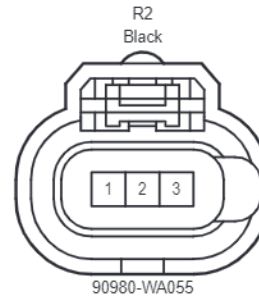
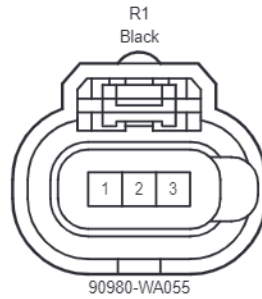
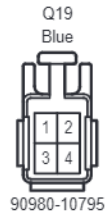
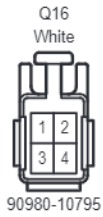
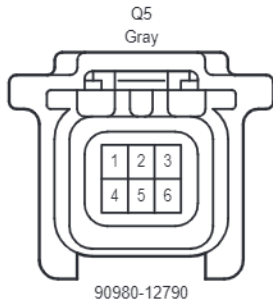

a1  
White

h1  
Black

j1  
Black

\*1 : Prior May 2015  
\*2 : May 2015 or later

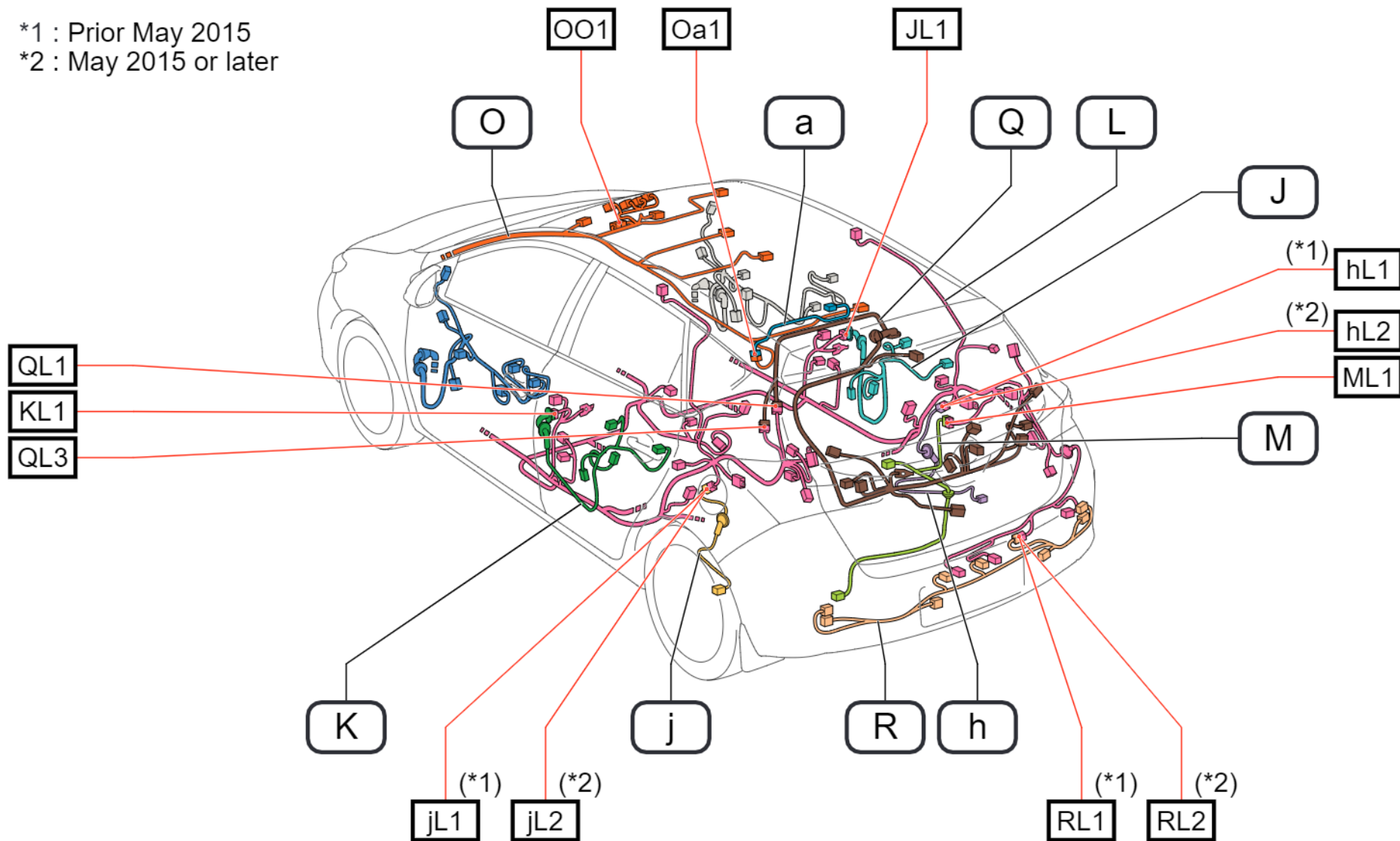

Wire and Wire in Body <LHD H/B>

JL1  
White

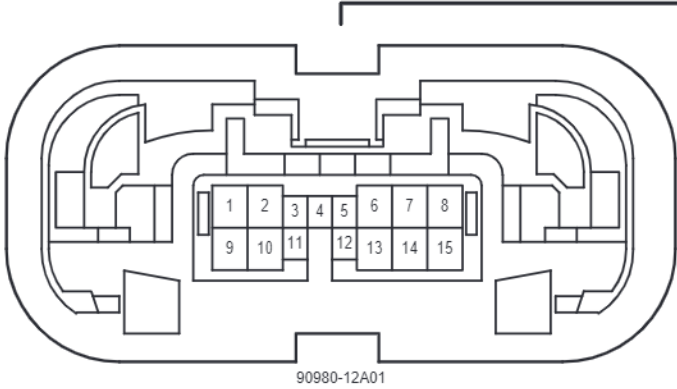

90980-12A01

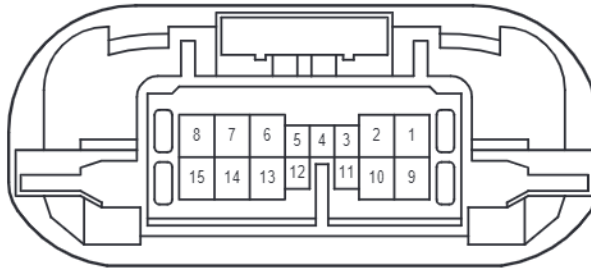

90980-12A00

KL1  
White

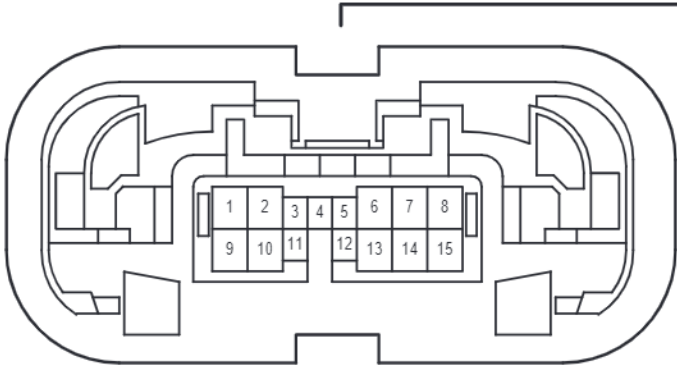

90980-12A01

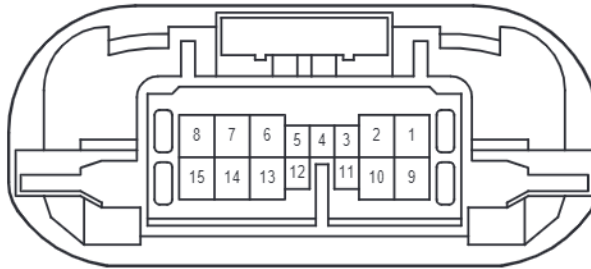

90980-12A00

ML1  
White

OO1  
Gray

Oa1  
White

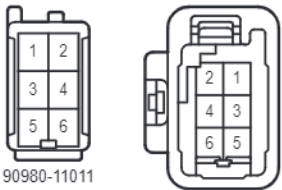

90980-11011

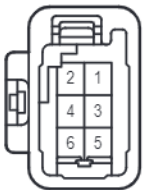

90980-11452



90980-12937

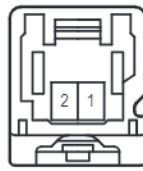

90980-12936

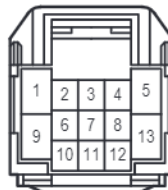

90980-12500

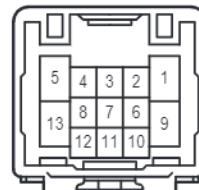

90980-12499

QL1  
White

QL3  
White

cardiagn.com



Wire and Wire in Body <LHD H/B>

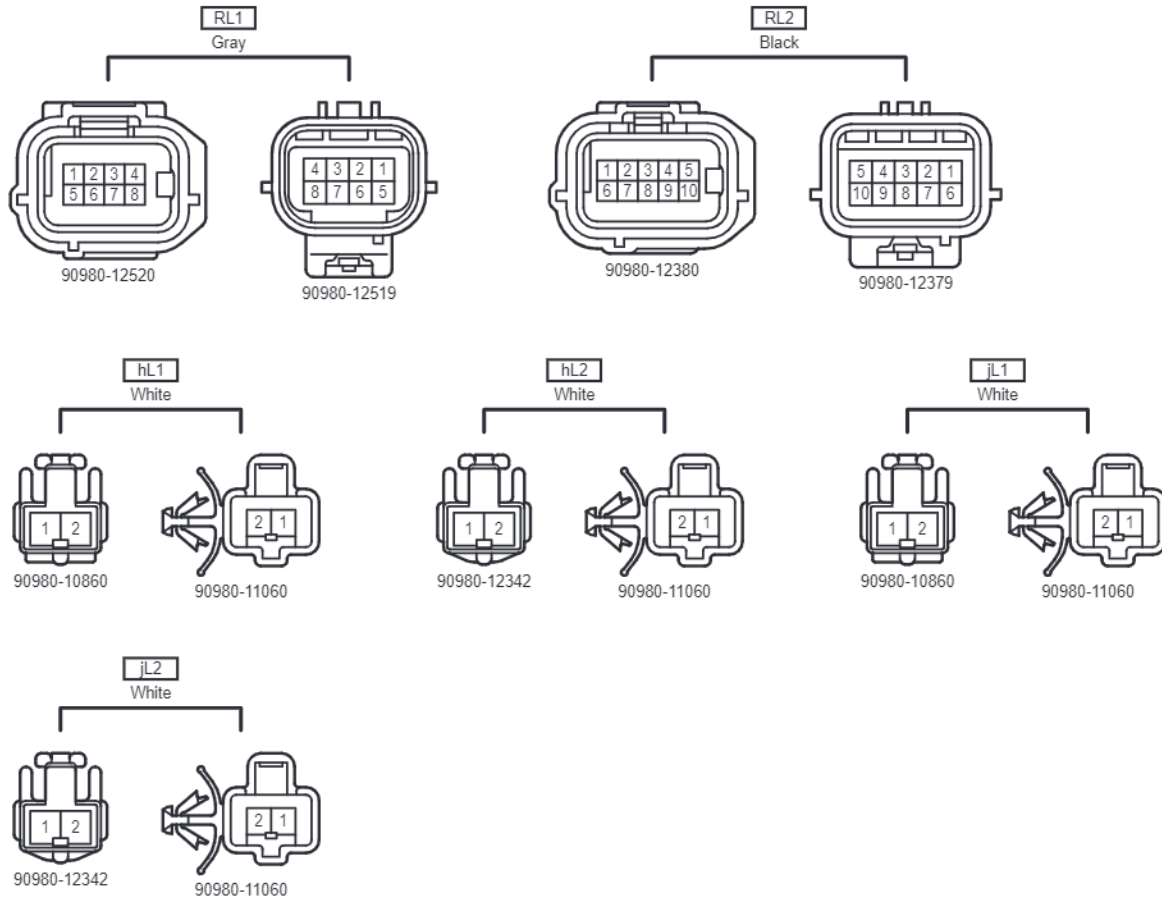

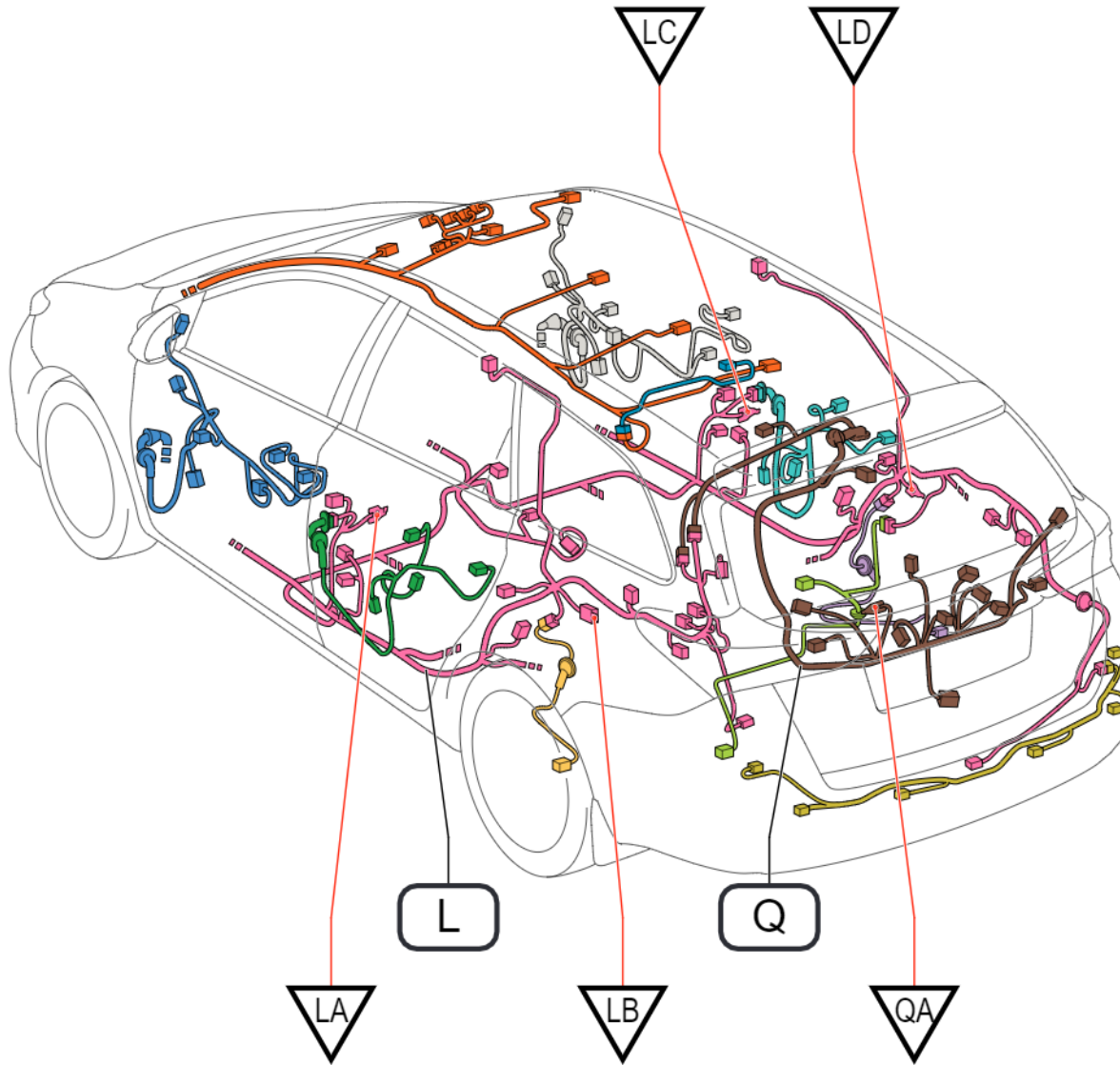

Position of Parts in Body <LHD W/G>

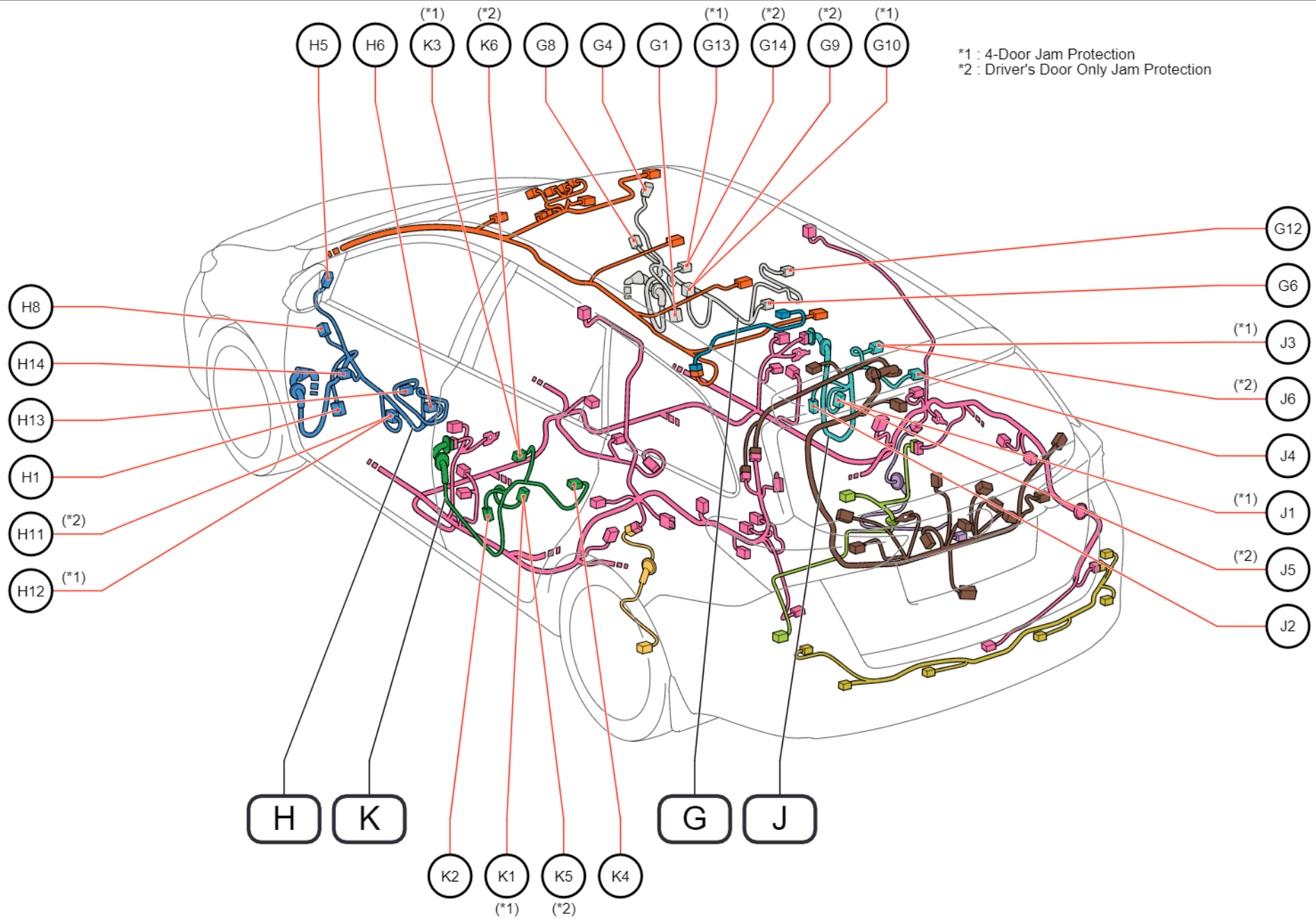

Position of Parts in Body <LHD W/G>

---

- G 1 Front No. 1 Speaker Assembly RH
- G 4 Front No. 2 Speaker Assembly RH
- G 6 Front Door Lock Assembly RH
- G 8 Outer Rear View Mirror Assembly RH
- G 9 Front Power Window Regulator Switch Assembly RH
- G 10 Front Power Window Regulator Switch Assembly RH
- G 12 Front Door Outside Handle Assembly RH
- G 13 Front Power Window Regulator Motor Assembly RH
- G 14 Front Power Window Regulator Motor Assembly RH

- H 1 Front No. 1 Speaker Assembly LH
- H 5 Front No. 2 Speaker Assembly LH
- H 6 Front Door Lock Assembly LH
- H 8 Outer Rear View Mirror Assembly LH
- H 11 Power Window Regulator Master Switch Assembly
- H 12 Power Window Regulator Master Switch Assembly
- H 13 Front Door Outside Handle Assembly LH
- H 14 Front Power Window Regulator Motor Assembly LH

- J 1 Rear Power Window Regulator Switch Assembly RH
- J 2 Rear Speaker Assembly RH
- J 3 Rear Power Window Regulator Motor Assembly RH
- J 4 Rear Door Lock Assembly RH
- J 5 Rear Power Window Regulator Switch Assembly RH
- J 6 Rear Power Window Regulator Motor Assembly RH

- K 1 Rear Power Window Regulator Switch Assembly LH
- K 2 Rear Speaker Assembly LH
- K 3 Rear Power Window Regulator Motor Assembly LH
- K 4 Rear Door Lock Assembly LH
- K 5 Rear Power Window Regulator Switch Assembly LH
- K 6 Rear Power Window Regulator Motor Assembly LH

Position of Parts in Body <LHD W/G>

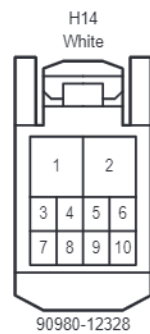
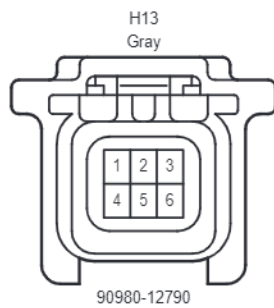
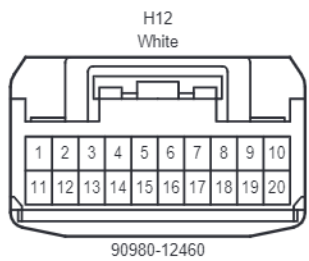
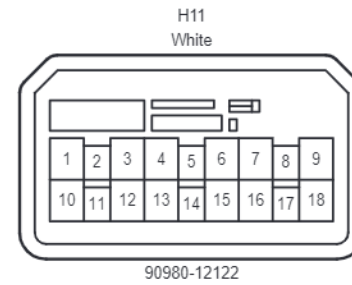
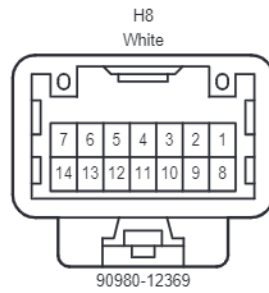
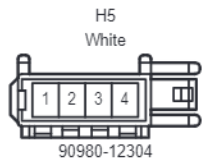
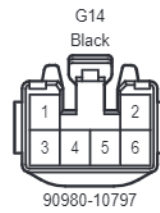
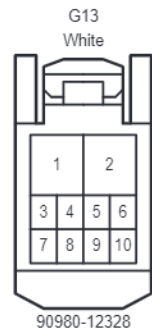
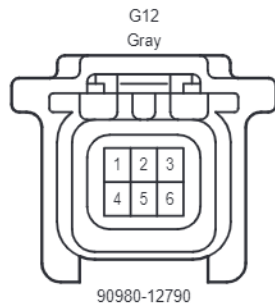
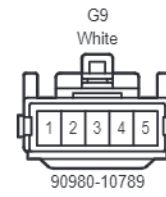
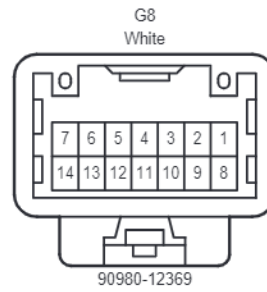
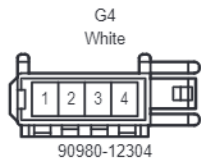

cardiagn.com

Position of Parts in Body <LHD W/G>

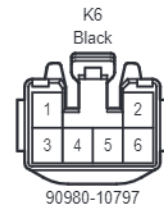
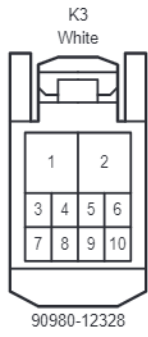
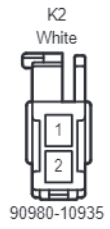

Position of Parts in Body <LHD W/G>

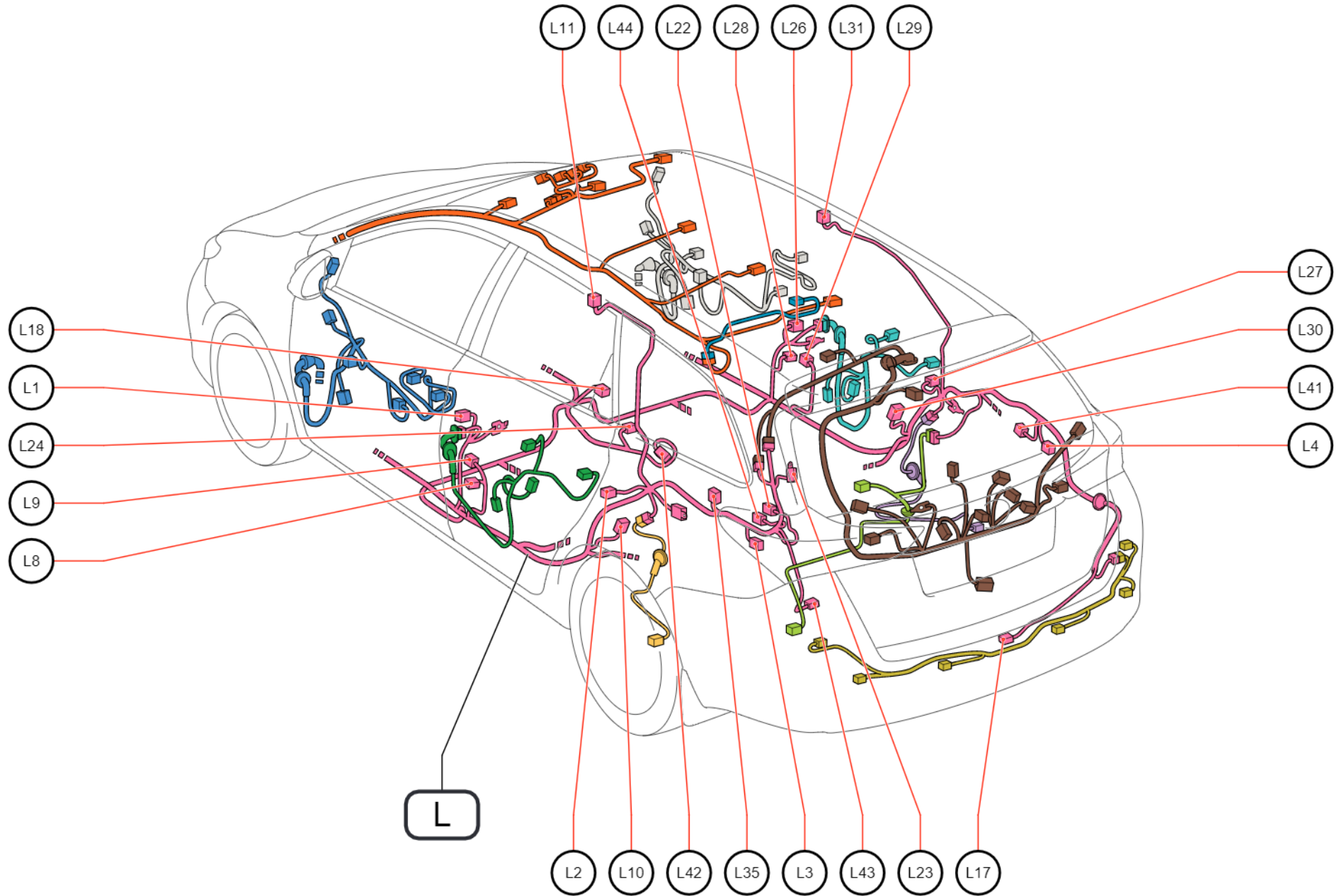

Position of Parts in Body <LHD W/G>

---

- L 1 Front Door Courtesy Light Switch Assembly LH
- L 2 Rear Door Courtesy Light Switch Assembly LH
- L 3 Rear Combination Light Assembly LH
- L 4 Rear Combination Light Assembly RH
- L 8 Front Seat Outer Belt Assembly LH
- L 9 Side Airbag Sensor Assembly LH
- L 10 Rear Side Airbag Sensor LH
- L 11 Curtain Shield Airbag Assembly LH
- L 17 Rear Electrical Key Antenna
- L 18 Parking Brake Switch Assembly
- L 22 No. 1 Luggage Compartment Light Assembly
- L 23 Noise Filter (Radio Setting Condenser)
- L 24 No. 3 Indoor Electrical Key Antenna Assembly
- L 26 Front Door Courtesy Light Switch Assembly RH
- L 27 Rear Door Courtesy Light Switch Assembly RH
- L 28 Front Seat Outer Belt Assembly RH
- L 29 Side Airbag Sensor Assembly RH
- L 30 Rear Side Airbag Sensor RH
- L 31 Curtain Shield Airbag Assembly RH
- L 35 Door Control Receiver
- L 41 No. 2 Clearance Warning Buzzer
- L 42 No. 2 Power Outlet Socket Assembly
- L 43 Rear No. 1 Power Outlet Socket Assembly
- L 44 No. 1 Speaker with Box Assembly



Position of Parts in Body <LHD W/G>

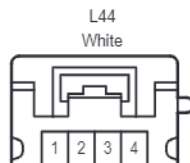
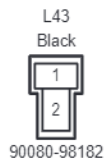
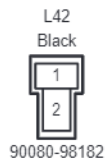
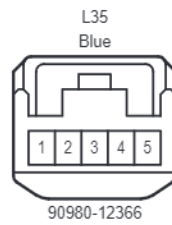
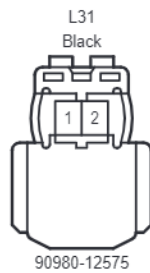
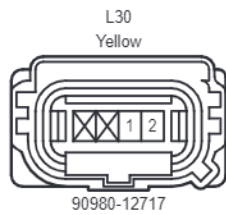
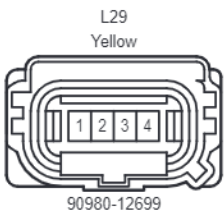
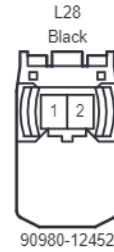
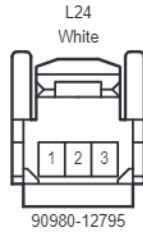
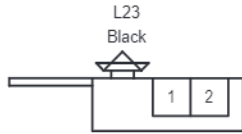
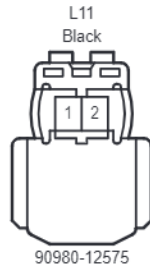
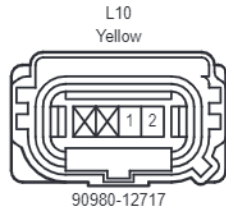
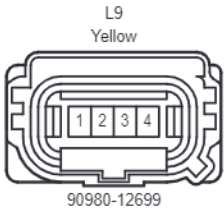
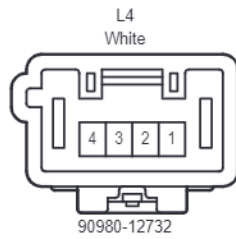
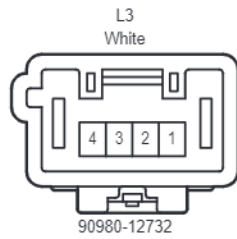

Position of Parts in Body <LHD W/G>

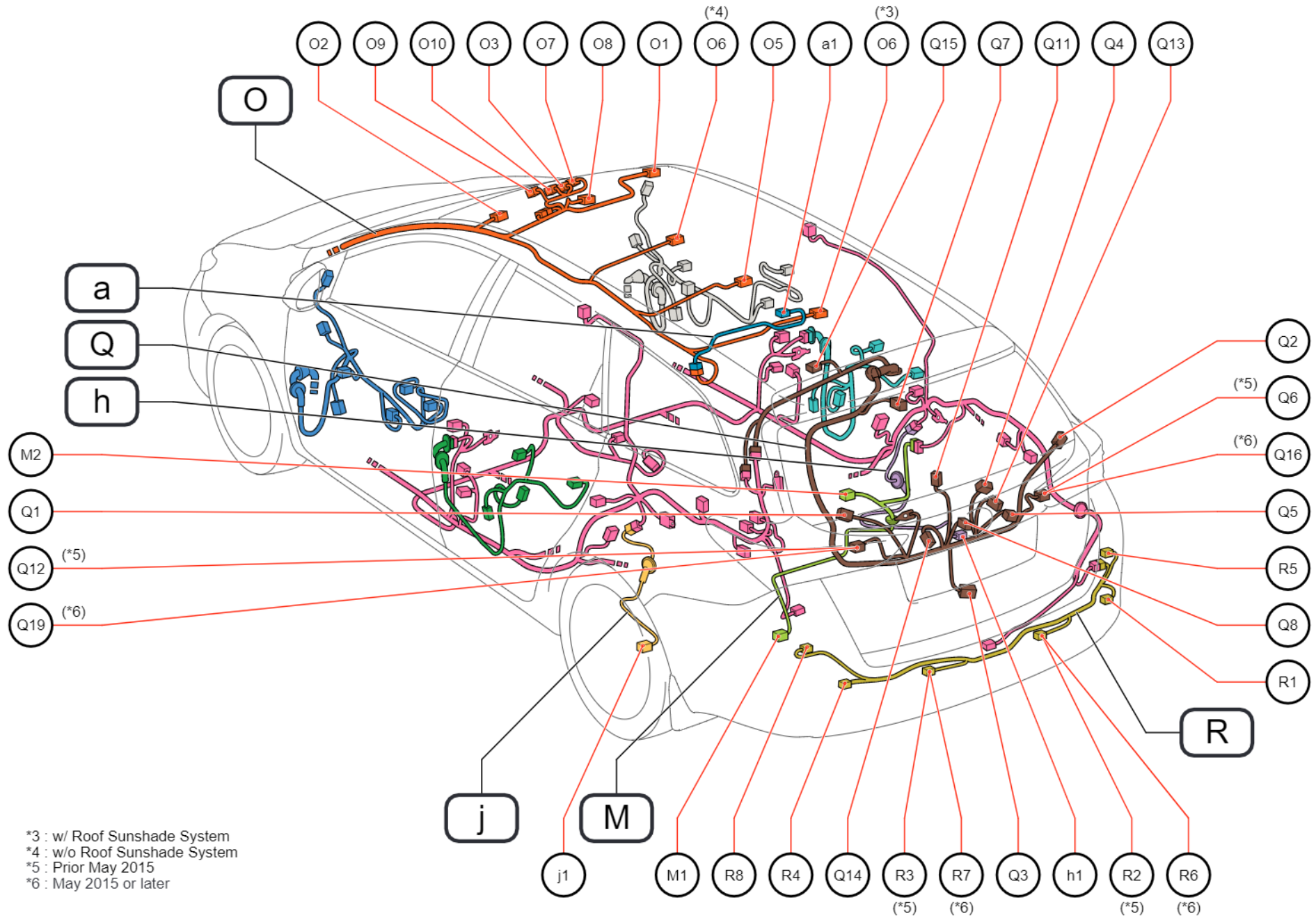

Position of Parts in Body <LHD W/G>

---

- M 1 Rear Height Control Sensor Sub-Assembly
- M 2 No. 1 Indoor Electrical Key Antenna Assembly

- O 1 Vanity Light Assembly RH
- O 2 Vanity Light Assembly LH
- O 3 Inner Rear View Mirror Assembly
- O 5 Rear Room Light (No. 1 Room Light Assembly)
- O 6 Dome Light (No. 1 Room Light Assembly)
- O 7 Rain Sensor
- O 8 Map Light Assembly
- O 9 Precrash Safety City Sensor
- O 10 Precrash Safety City Heater

- Q 1 Rear Window Defogger (Back Door Glass)
- Q 2 Rear Window Defogger (Back Door Glass)
- Q 3 Back Door Lock Assembly
- Q 4 Rear Wiper Motor Assembly
- Q 5 Rear Television Camera Assembly
- Q 6 Rear Light Assembly RH
- Q 7 Center Stop Light Assembly
- Q 8 Back Door Opener Switch Assembly
- Q 11 Glass Breakage Sensor (Back Door Glass)
- Q 12 Rear Light Assembly LH
- Q 13 License Plate Light Assembly RH
- Q 14 License Plate Light Assembly LH
- Q 15 Tire Pressure Monitor Receiver Assembly
- Q 16 Rear Light Assembly RH
- Q 19 Rear Light Assembly LH

- R 1 Rear No. 1 Ultrasonic Sensor RH
- R 2 Rear No. 1 Ultrasonic Sensor Center RH
- R 3 Rear No. 1 Ultrasonic Sensor Center LH
- R 4 Rear No. 1 Ultrasonic Sensor LH
- R 5 Rear No. 1 Ultrasonic Sensor RH
- R 6 Rear No. 1 Ultrasonic Sensor Center RH
- R 7 Rear No. 1 Ultrasonic Sensor Center LH
- R 8 Rear No. 1 Ultrasonic Sensor LH

- a 1 Sliding Roof Drive Gear Assembly

- h 1 Rear Speed Sensor RH

Position of Parts in Body <LHD W/G>

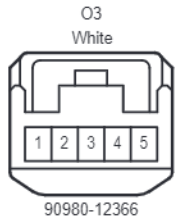
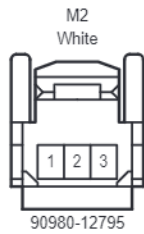

(Except November 2016 or later w/ Precrash System)

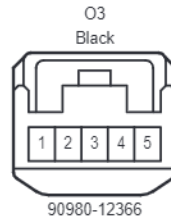

(November 2016 or later w/ Precrash System)

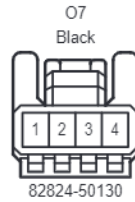
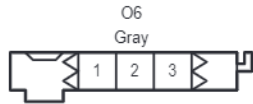

(Except November 2016 or later w/ Precrash System)

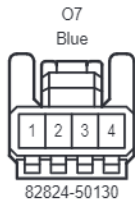

(November 2016 or later w/ Precrash System)

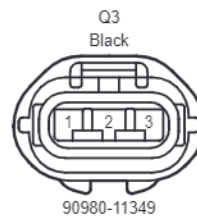
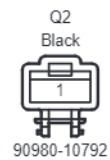
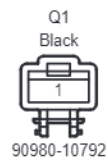
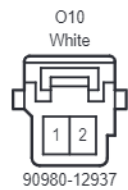
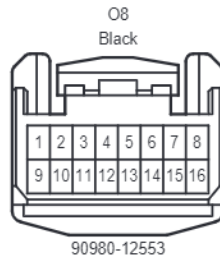

Position of Parts in Body <LHD W/G>

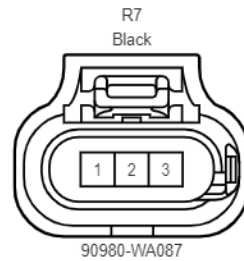
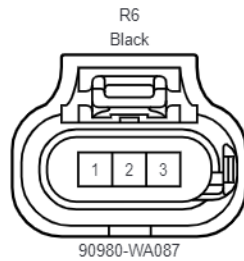
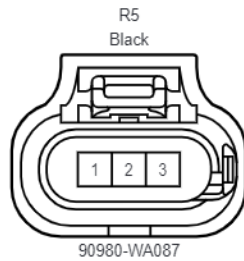
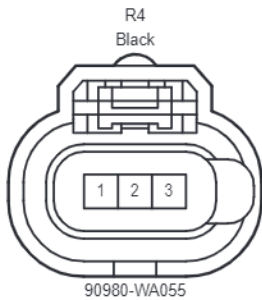
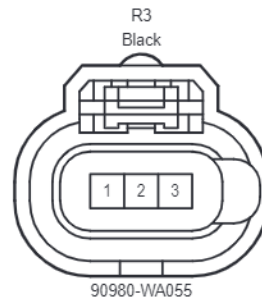
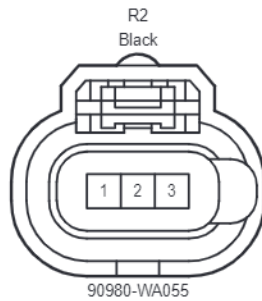
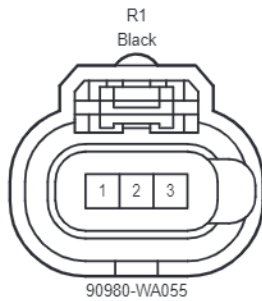
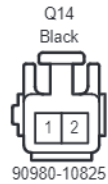
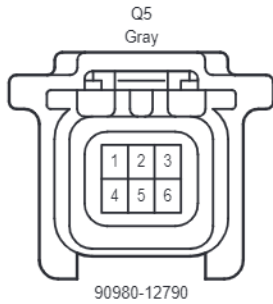

cardiagn.com

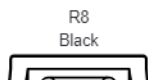

- \*1 : Prior May 2014
- \*2 : May 2014 or later
- \*3 : Prior May 2015
- \*4 : May 2015 or later

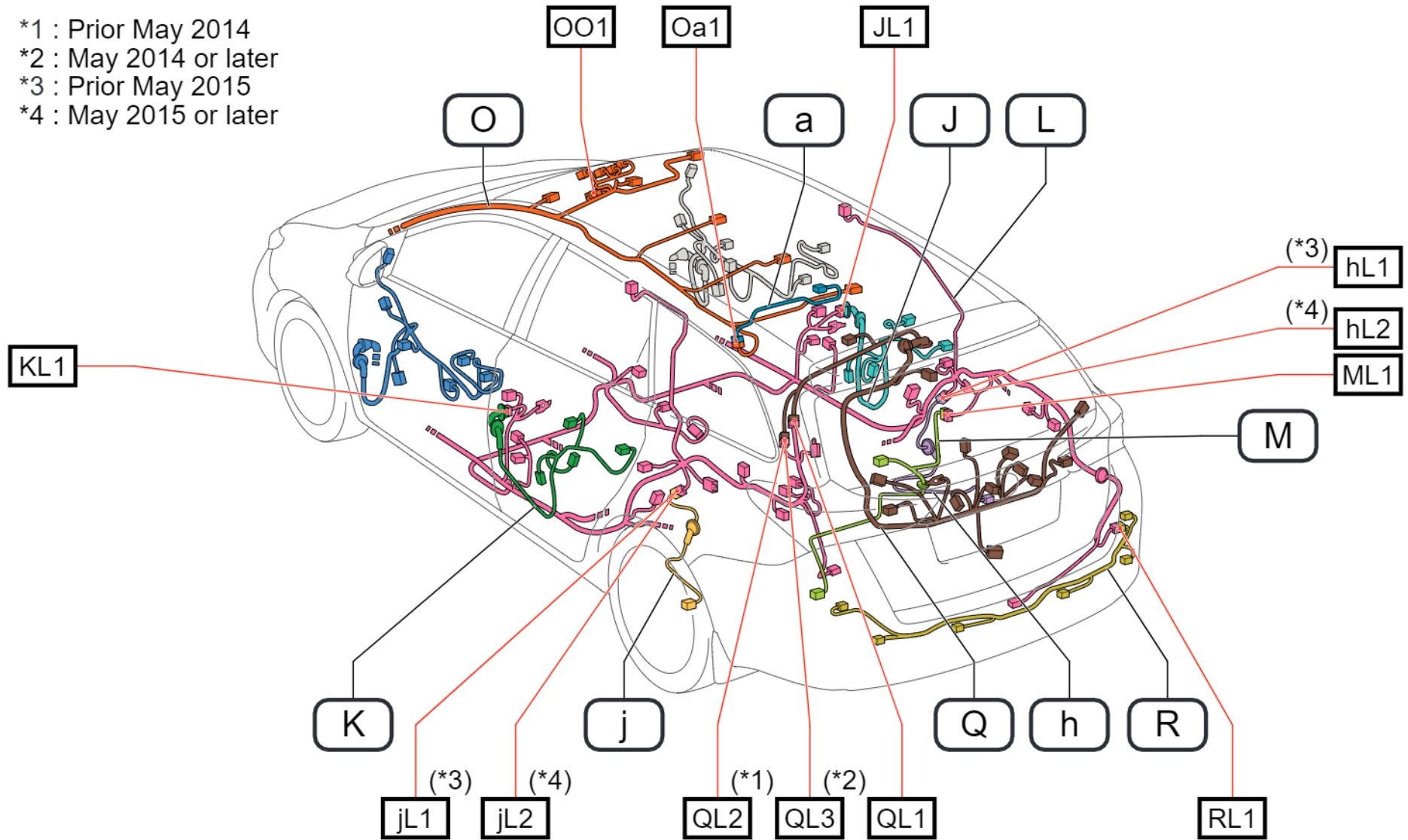

Wire and Wire in Body <LHD W/G>

JL1  
White

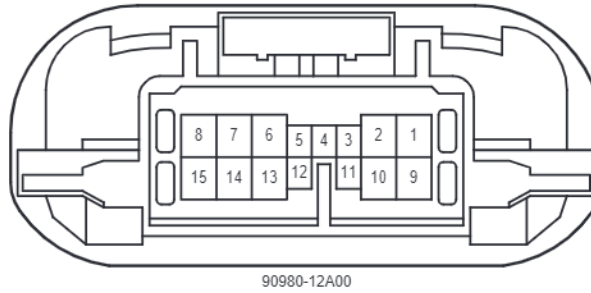
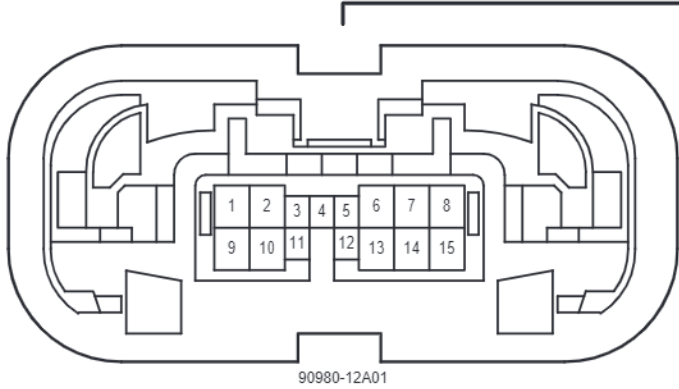

KL1  
White

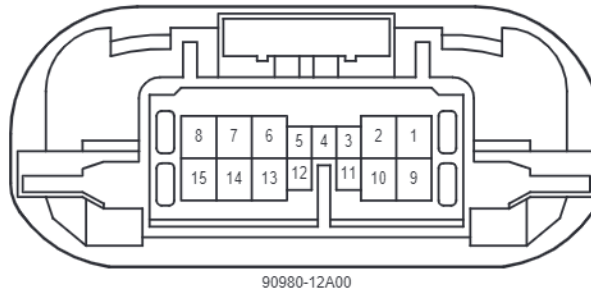
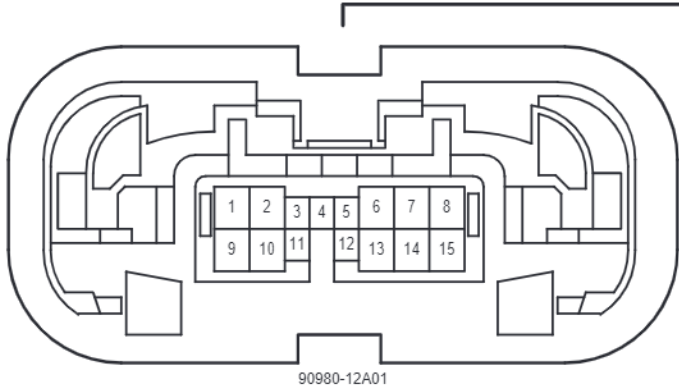

ML1  
White

OO1  
Gray

Oa1  
White

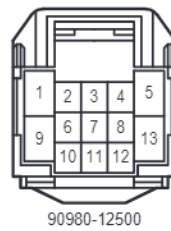
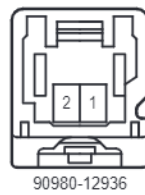
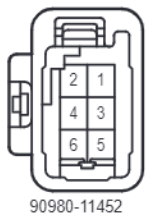
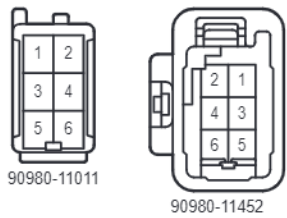

QL1  
White

QL2  
White

cardiagn.com

Wire and Wire in Body <LHD W/G>

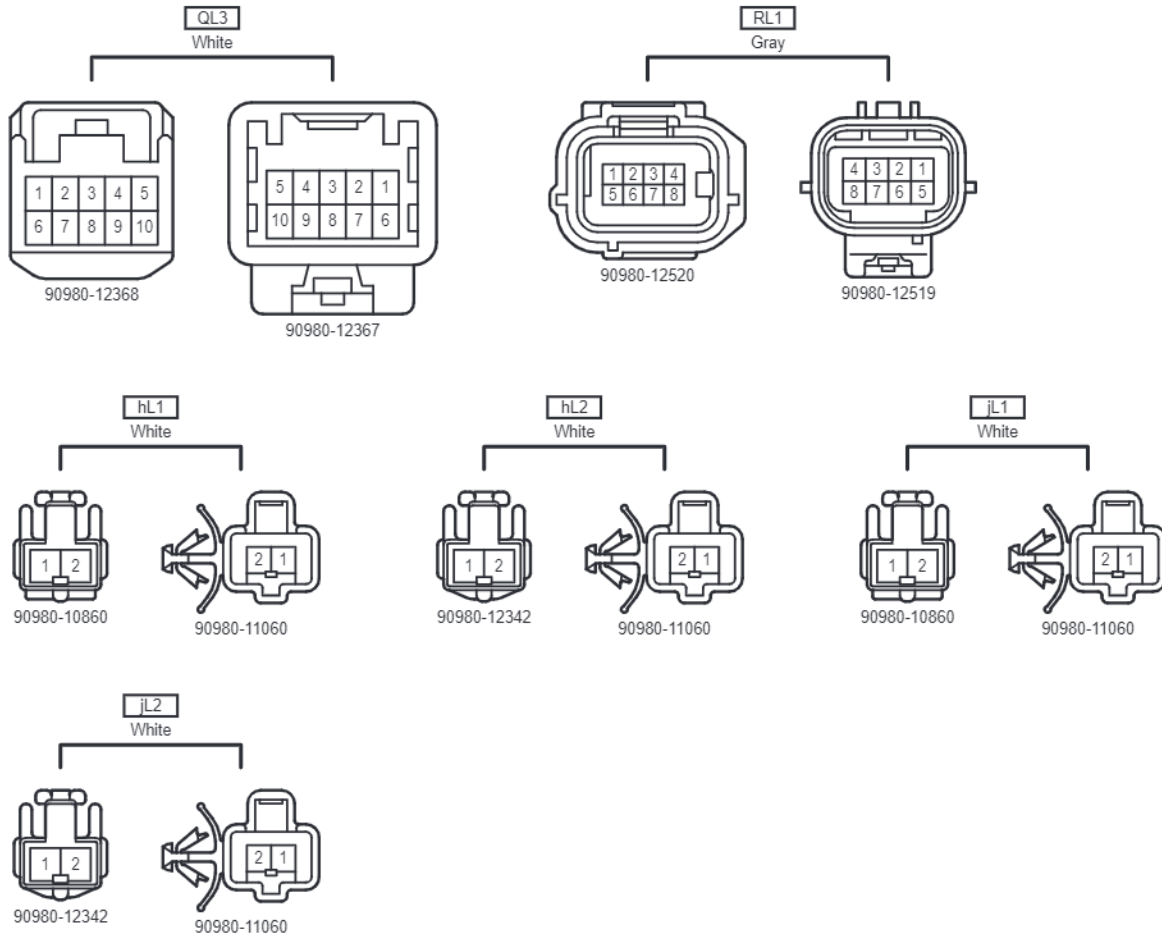



Ground Points in Body <RHD H/B>

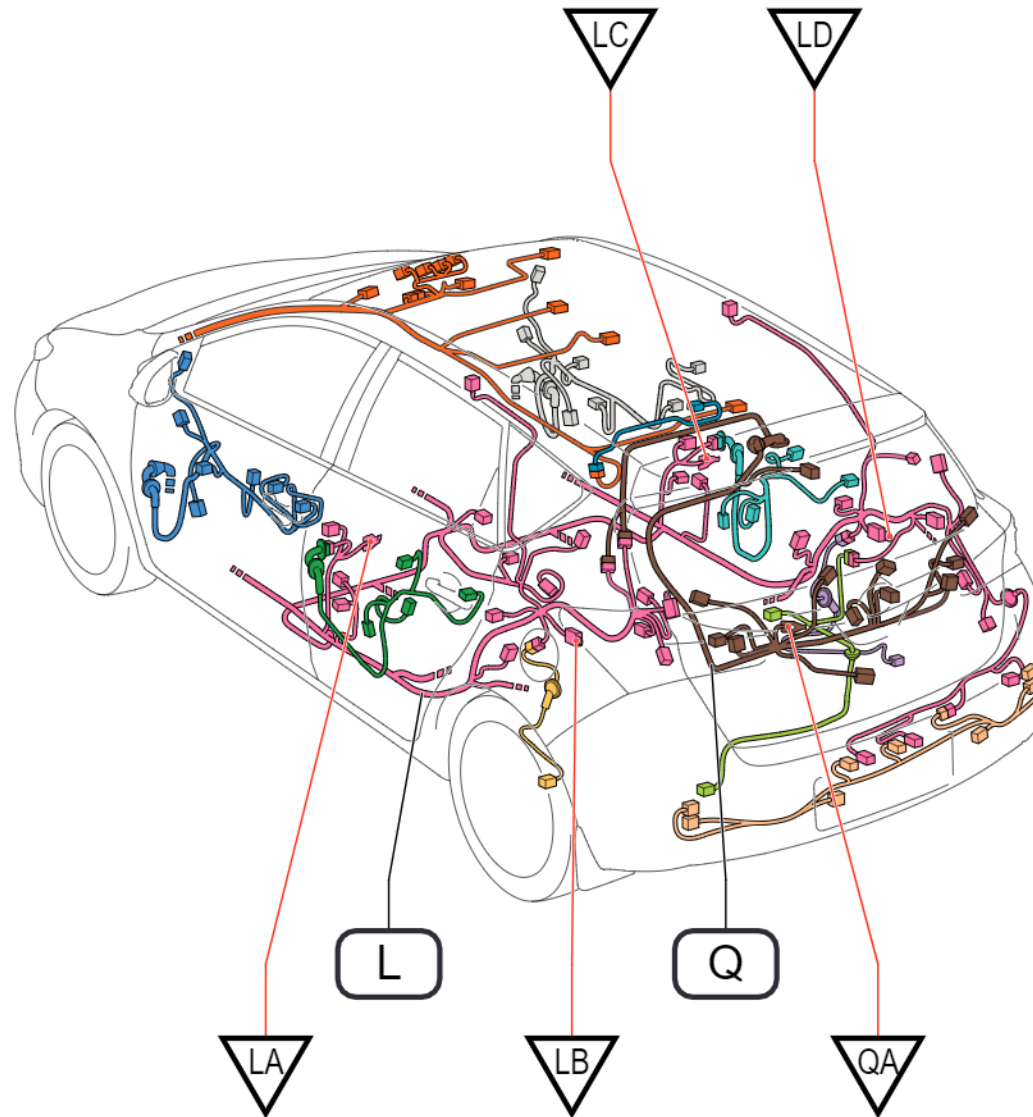

Position of Parts in Body <RHD H/B>

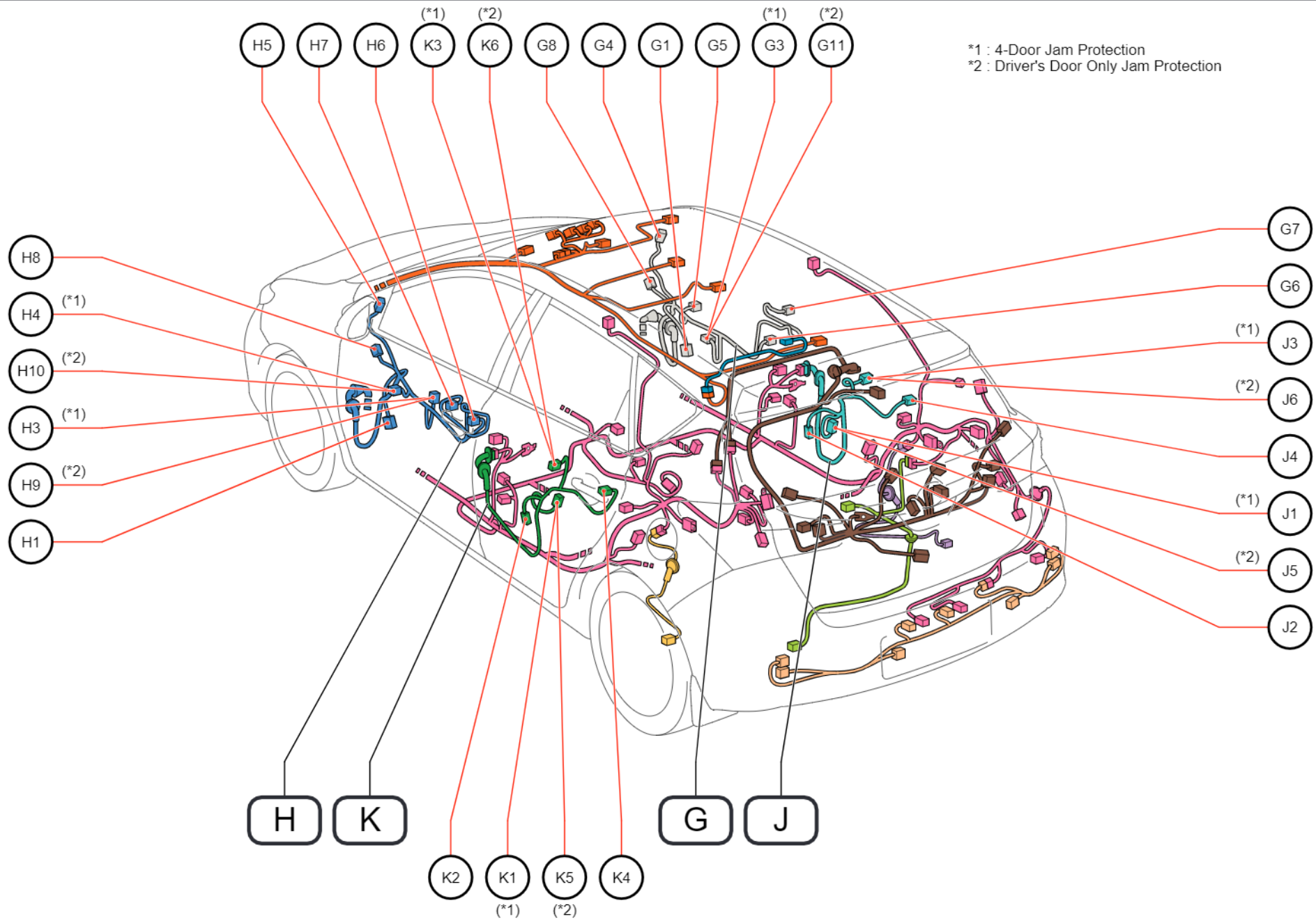

Position of Parts in Body <RHD H/B>

---

- G 1 Front No. 1 Speaker Assembly RH
- G 3 Power Window Regulator Master Switch Assembly
- G 4 Front No. 2 Speaker Assembly RH
- G 5 Front Power Window Regulator Motor Assembly RH
- G 6 Front Door Lock Assembly RH
- G 7 Front Door Outside Handle Assembly RH
- G 8 Outer Rear View Mirror Assembly RH
- G 11 Power Window Regulator Master Switch Assembly
  
- H 1 Front No. 1 Speaker Assembly LH
- H 3 Front Power Window Regulator Switch Assembly LH
- H 4 Front Power Window Regulator Motor Assembly LH
- H 5 Front No. 2 Speaker Assembly LH
- H 6 Front Door Lock Assembly LH
- H 7 Front Door Outside Handle Assembly LH
- H 8 Outer Rear View Mirror Assembly LH
- H 9 Front Power Window Regulator Switch Assembly LH
- H 10 Power Window Regulator Motor Assembly LH
  
- J 1 Rear Power Window Regulator Switch Assembly RH
- J 2 Rear Speaker Assembly RH
- J 3 Rear Power Window Regulator Motor Assembly RH
- J 4 Rear Door Lock Assembly RH
- J 5 Rear Power Window Regulator Switch Assembly RH
- J 6 Rear Power Window Regulator Motor Assembly RH
  
- K 1 Rear Power Window Regulator Switch Assembly LH
- K 2 Rear Speaker Assembly LH
- K 3 Rear Power Window Regulator Motor Assembly LH
- K 4 Rear Door Lock Assembly LH
- K 5 Rear Power Window Regulator Switch Assembly LH
- K 6 Rear Power Window Regulator Motor Assembly LH

Position of Parts in Body <RHD H/B>



90980-10935

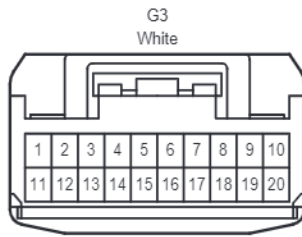

90980-12460

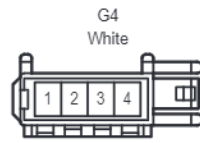

90980-12304

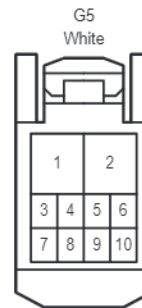

90980-12328



90980-12226

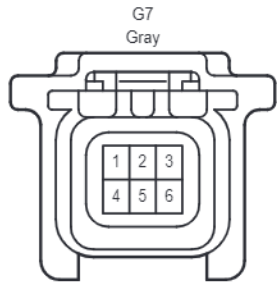

90980-12790

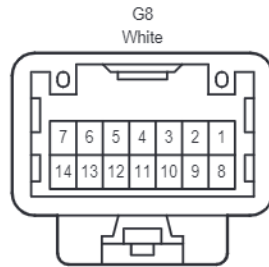

90980-12369

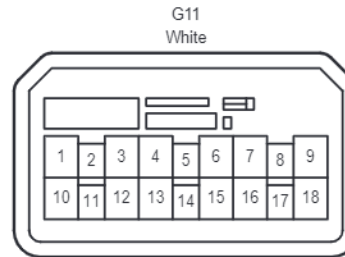

90980-12122



90980-10935

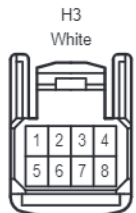

90980-12551

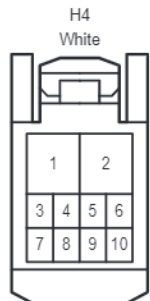

90980-12328

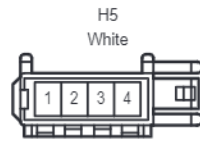

90980-12304

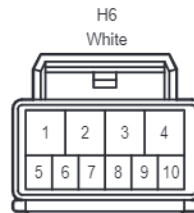

90980-12226

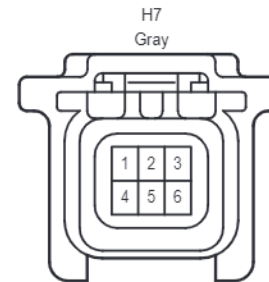

90980-12790

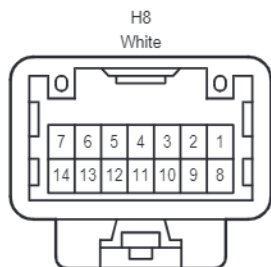

90980-12369

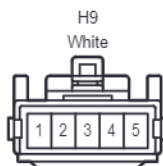

90980-10789

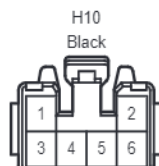

90980-10797

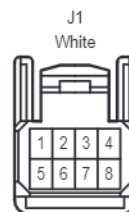

90980-12551



90980-10935

Position of Parts in Body <RHD H/B>

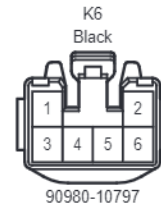
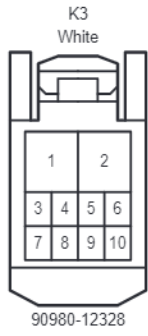
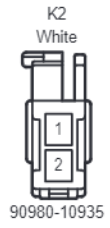

Position of Parts in Body <RHD H/B>

\*1 : Refer to the Service Bulletin  
for the installation position of the parts.

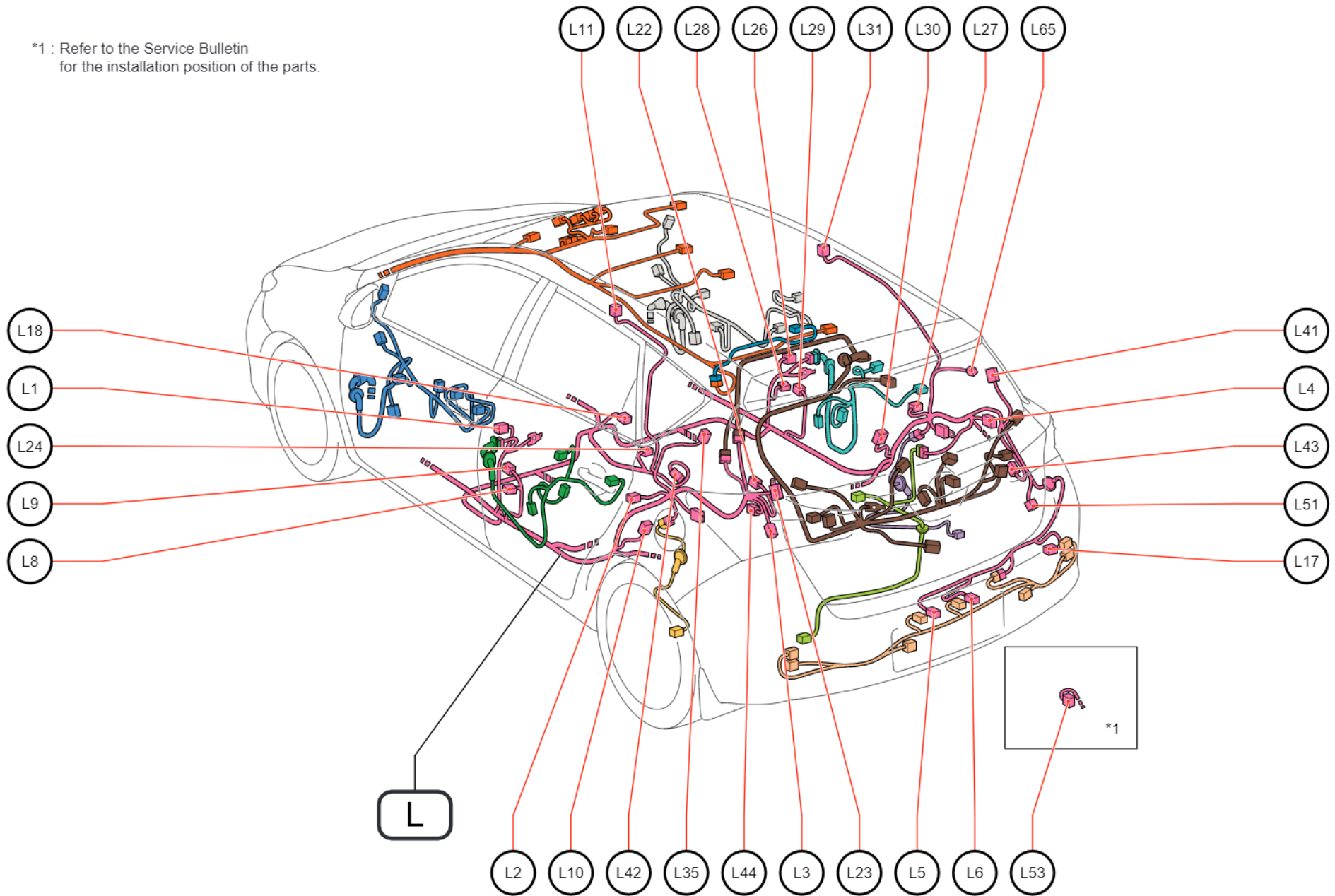

Position of Parts in Body <RHD H/B>

---

- L 1 Front Door Courtesy Light Switch Assembly LH
- L 2 Rear Door Courtesy Light Switch Assembly LH
- L 3 Rear Combination Light Assembly LH
- L 4 Rear Combination Light Assembly RH
- L 5 License Plate Light Assembly LH
- L 6 License Plate Light Assembly RH
- L 8 Front Seat Outer Belt Assembly LH
- L 9 Side Airbag Sensor Assembly LH
- L 10 Rear Side Airbag Sensor LH
- L 11 Curtain Shield Airbag Assembly LH
- L 17 Rear Electrical Key Antenna
- L 18 Parking Brake Switch Assembly
- L 22 No. 1 Luggage Compartment Light Assembly
- L 23 Noise Filter (Radio Setting Condenser)
- L 24 No. 3 Indoor Electrical Key Antenna Assembly
- L 26 Front Door Courtesy Light Switch Assembly RH
- L 27 Rear Door Courtesy Light Switch Assembly RH
- L 28 Front Seat Outer Belt Assembly RH
- L 29 Side Airbag Sensor Assembly RH
- L 30 Rear Side Airbag Sensor RH
- L 31 Curtain Shield Airbag Assembly RH
- L 35 Door Control Receiver
- L 41 No. 2 Clearance Warning Buzzer
- L 42 No. 2 Power Outlet Socket Assembly
- L 43 Rear No. 1 Power Outlet Socket Assembly
- L 44 No. 1 Speaker with Box Assembly
- L 51 Battery Thermometer Sensor
- L 53 Theft Warning Siren Assembly
- L 65 Tire Pressure Monitor Receiver Assembly

Position of Parts in Body <RHD H/B>

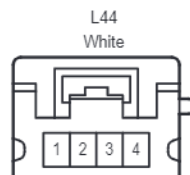
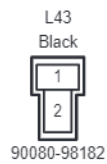
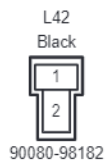
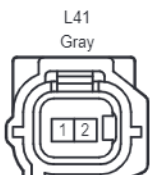
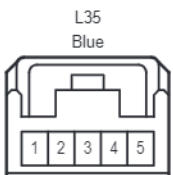
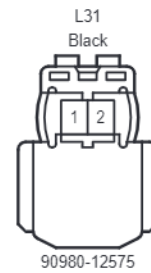
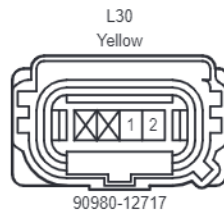
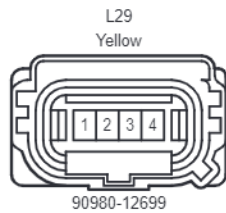
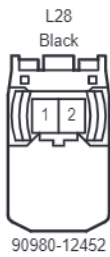
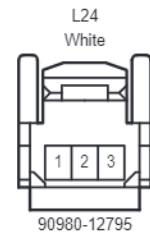
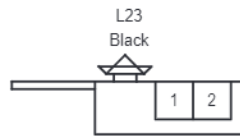
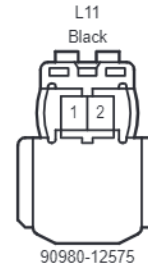
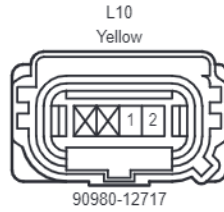
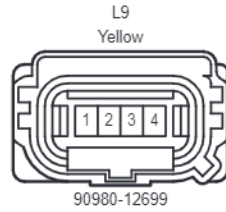
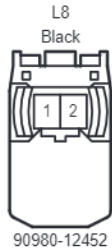
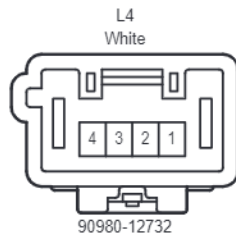
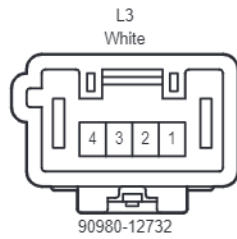



Position of Parts in Body <RHD H/B>

---

L53  
Black

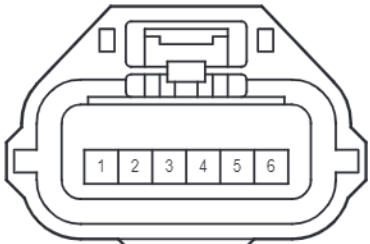

82824-53030

L65  
Black



90980-12552

Position of Parts in Body <RHD H/B>

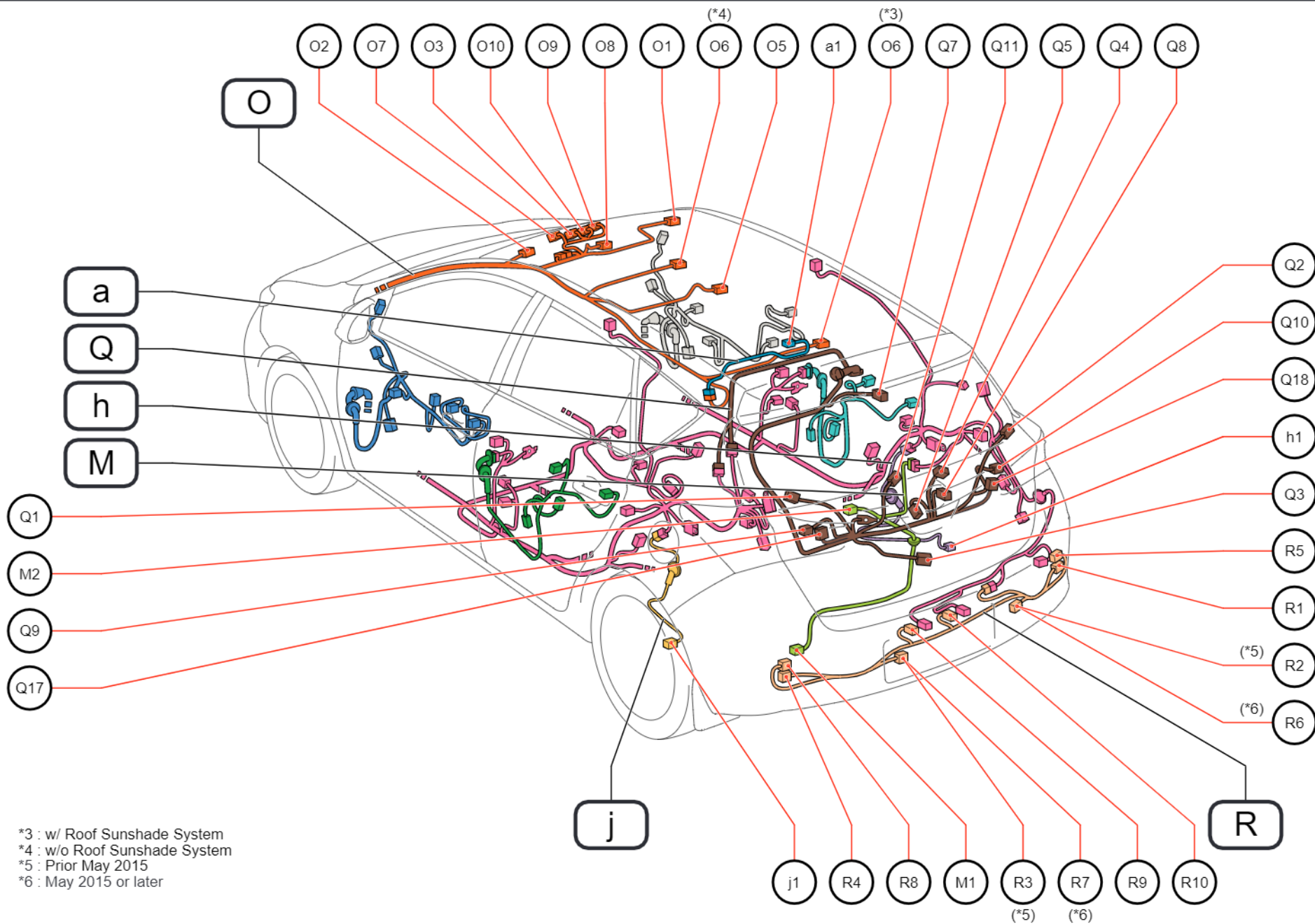

\*3 : w/ Roof Sunshade System  
 \*4 : w/o Roof Sunshade System  
 \*5 : Prior May 2015  
 \*6 : May 2015 or later

Position of Parts in Body <RHD H/B>

---

- M 1 Rear Height Control Sensor Sub-Assembly
- M 2 No. 1 Indoor Electrical Key Antenna Assembly

- O 1 Vanity Light Assembly RH
- O 2 Vanity Light Assembly LH
- O 3 Inner Rear View Mirror Assembly
- O 5 Rear Room Light (No. 1 Room Light Assembly)
- O 6 Dome Light (No. 1 Room Light Assembly)
- O 7 Rain Sensor
- O 8 Map Light Assembly
- O 9 Precrash Safety City Sensor
- O 10 Precrash Safety City Heater

- Q 1 Rear Window Defogger (Back Door Glass)
- Q 2 Rear Window Defogger (Back Door Glass)
- Q 3 Back Door Lock Assembly
- Q 4 Rear Wiper Motor Assembly
- Q 5 Rear Television Camera Assembly
- Q 7 Center Stop Light Assembly
- Q 8 Back Door Opener Switch Assembly
- Q 9 Rear Light Assembly LH
- Q 10 Rear Light Assembly RH
- Q 11 Glass Breakage Sensor (Back Door Glass)
- Q 17 Rear Light Assembly LH
- Q 18 Rear Light Assembly RH

- R 1 Rear No. 1 Ultrasonic Sensor RH
- R 2 Rear No. 1 Ultrasonic Sensor Center RH
- R 3 Rear No. 1 Ultrasonic Sensor Center LH
- R 4 Rear No. 1 Ultrasonic Sensor LH
- R 5 Rear No. 1 Ultrasonic Sensor RH
- R 6 Rear No. 1 Ultrasonic Sensor Center RH
- R 7 Rear No. 1 Ultrasonic Sensor Center LH
- R 8 Rear No. 1 Ultrasonic Sensor LH
- R 9 License Plate Light Assembly LH
- R 10 License Plate Light Assembly RH

- a 1 Sliding Roof Drive Gear Assembly

- h 1 Rear Speed Sensor RH

Position of Parts in Body <RHD H/B>

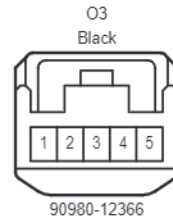
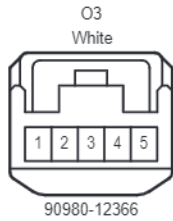
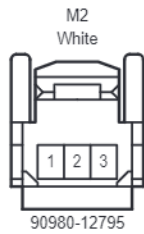

(Except November 2016 or later w/ Precrash System)

(November 2016 or later w/ Precrash System)

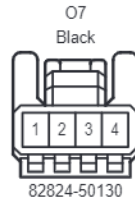
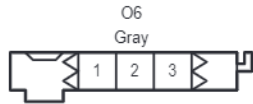

(Except November 2016 or later w/ Precrash System)

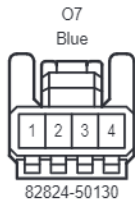

(November 2016 or later w/ Precrash System)

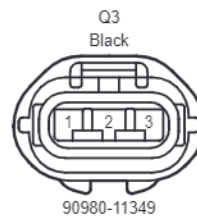
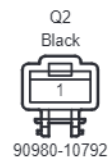
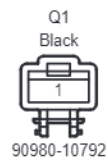
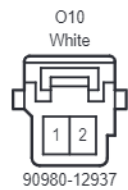
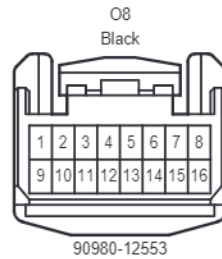

Position of Parts in Body <RHD H/B>

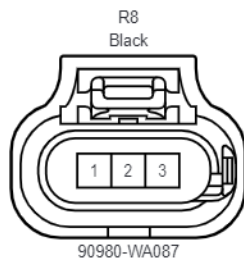
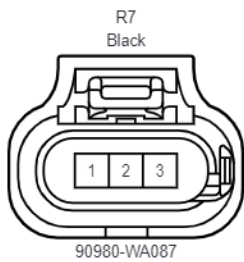
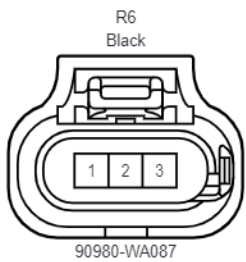
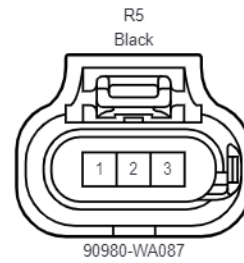
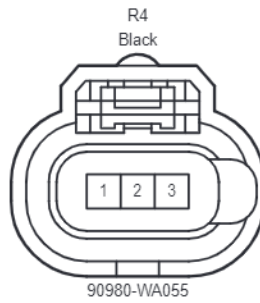
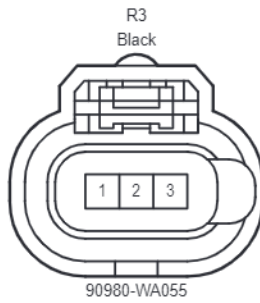
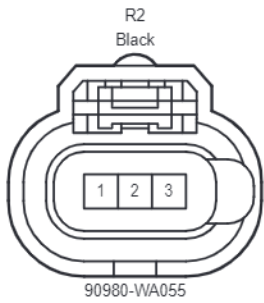
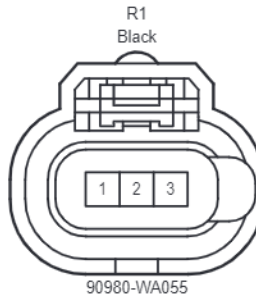
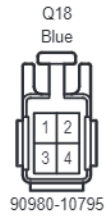
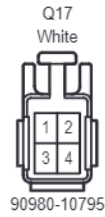
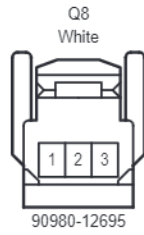
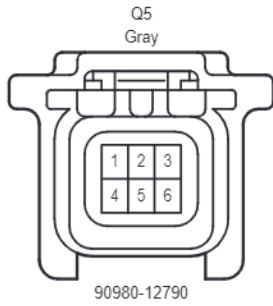

cardiagn.com



\*1 : Prior May 2015  
\*2 : May 2015 or later

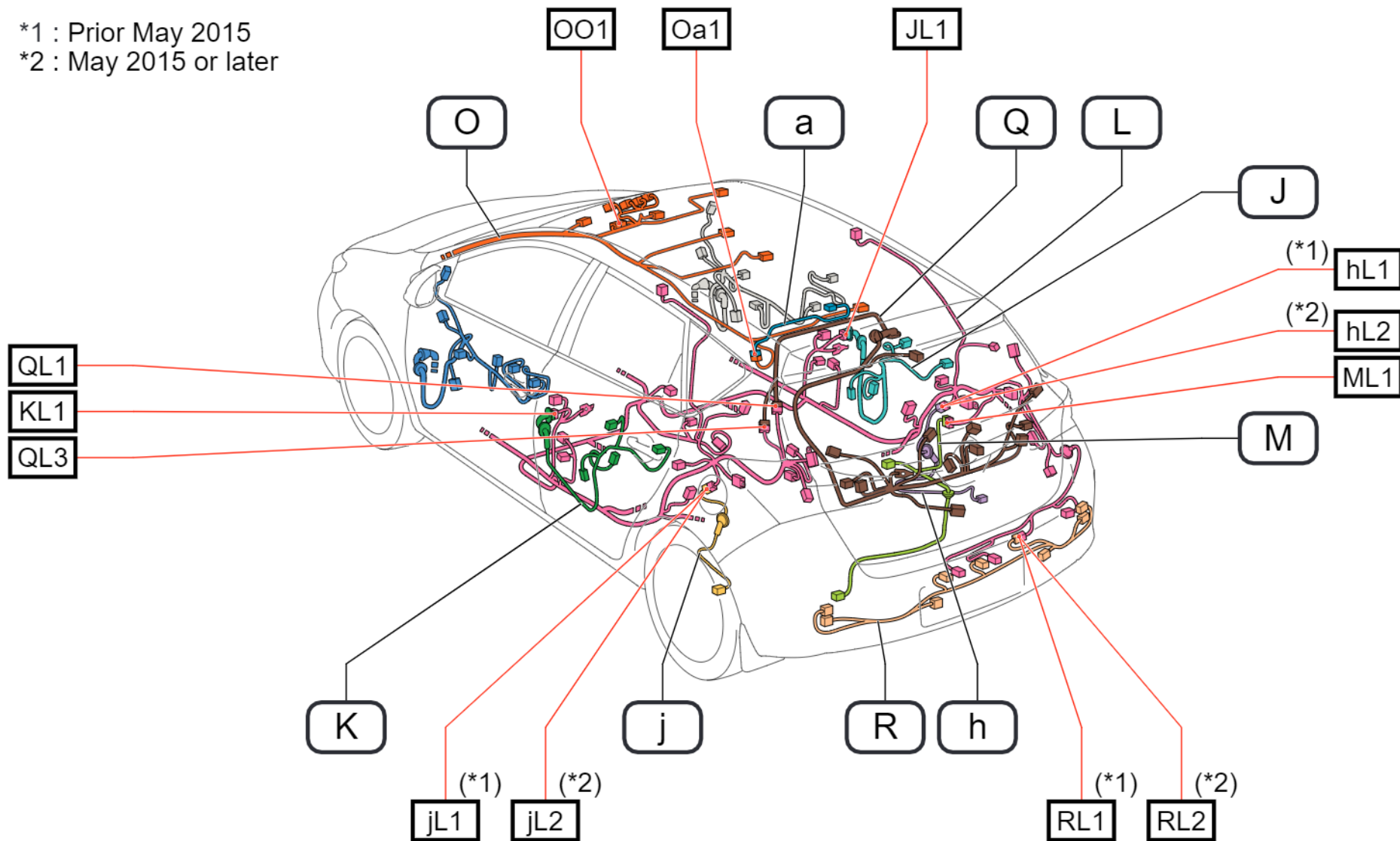

Wire and Wire in Body <RHD H/B>

JL1  
White

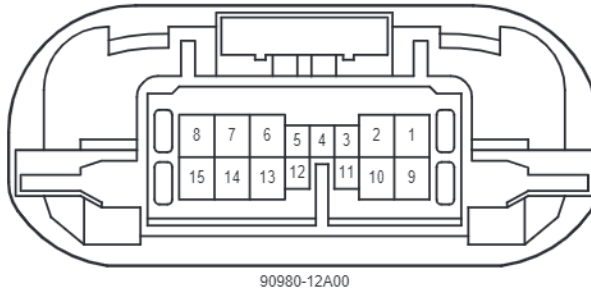
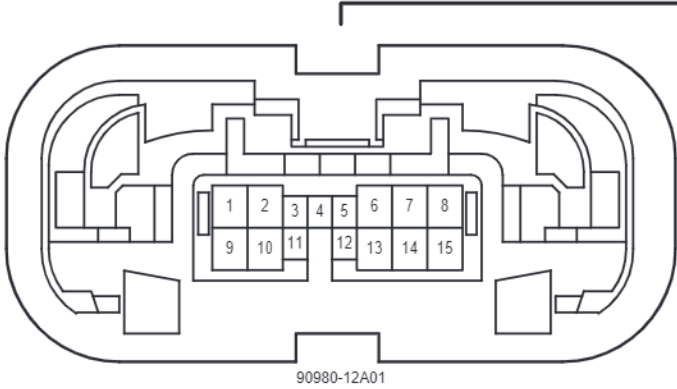

KL1  
White

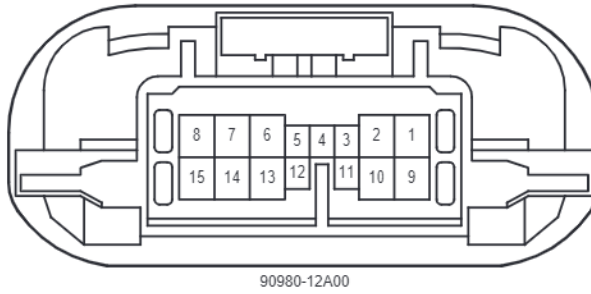
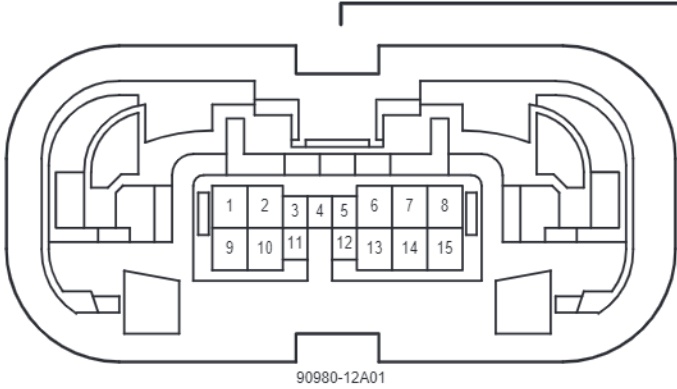

ML1  
White

OO1  
Gray

Oa1  
White

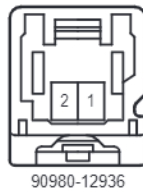
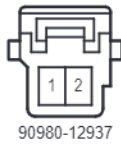
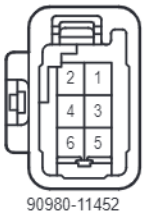
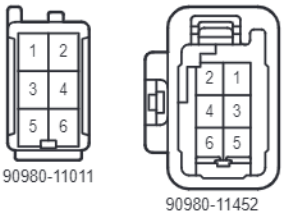

QL1  
White

QL3  
White

cardiagn.com

Wire and Wire in Body <RHD H/B>

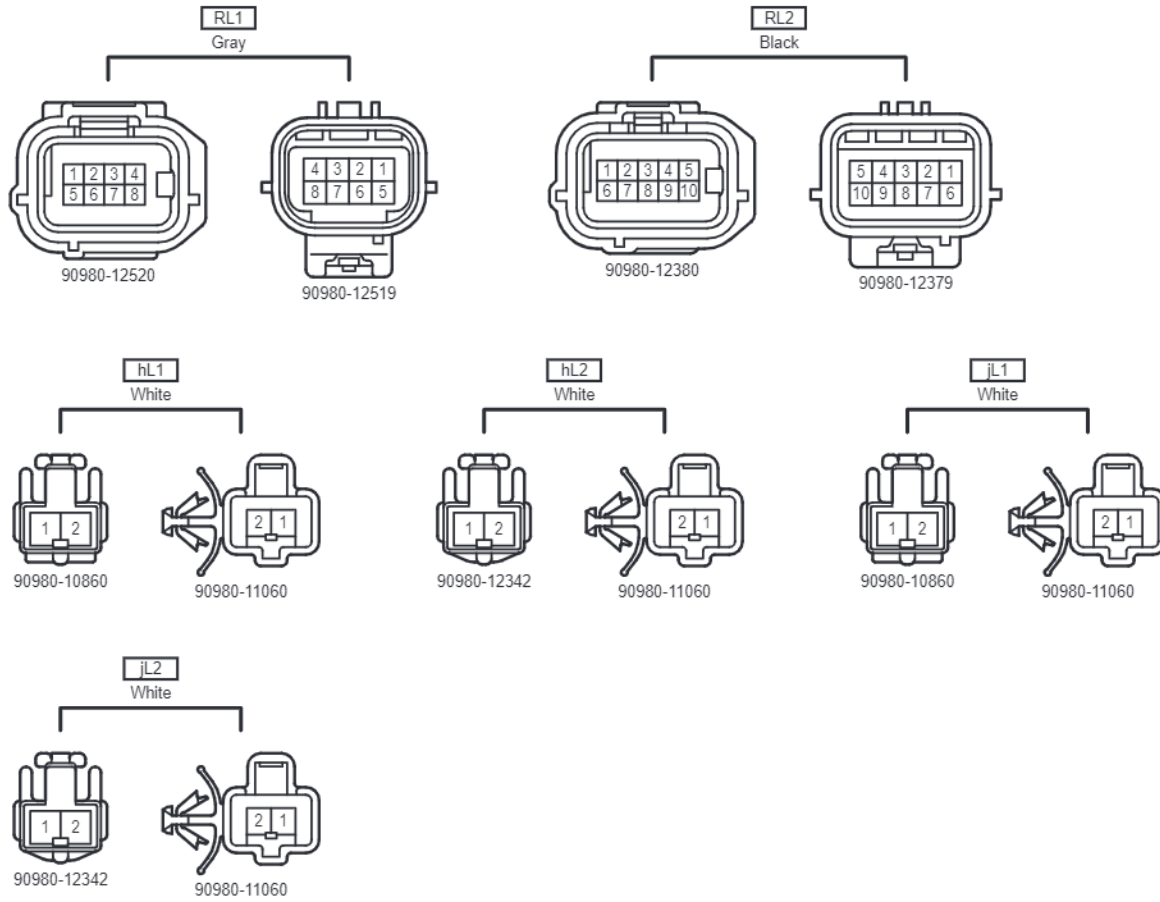



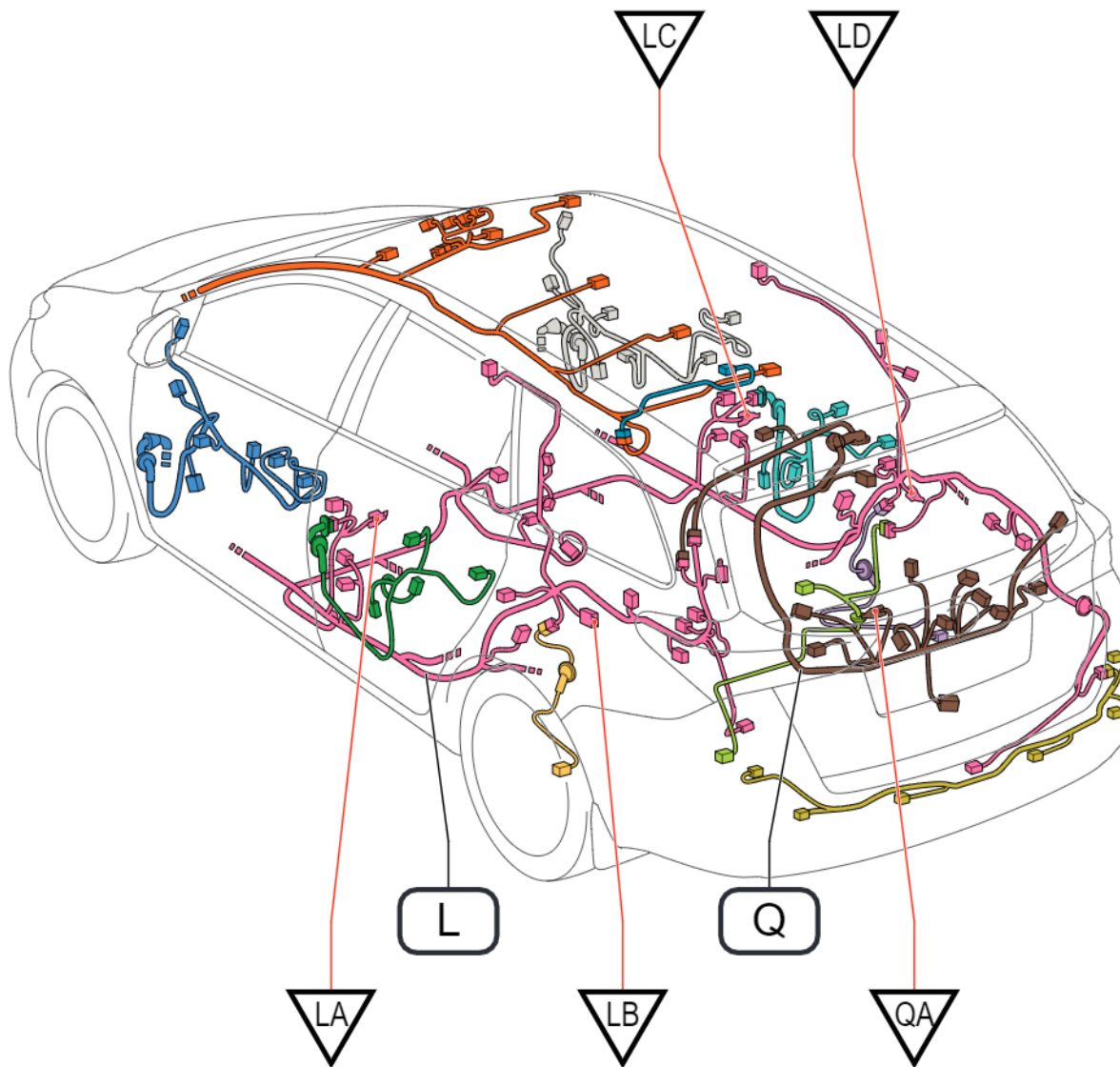

Position of Parts in Body <RHD W/G>

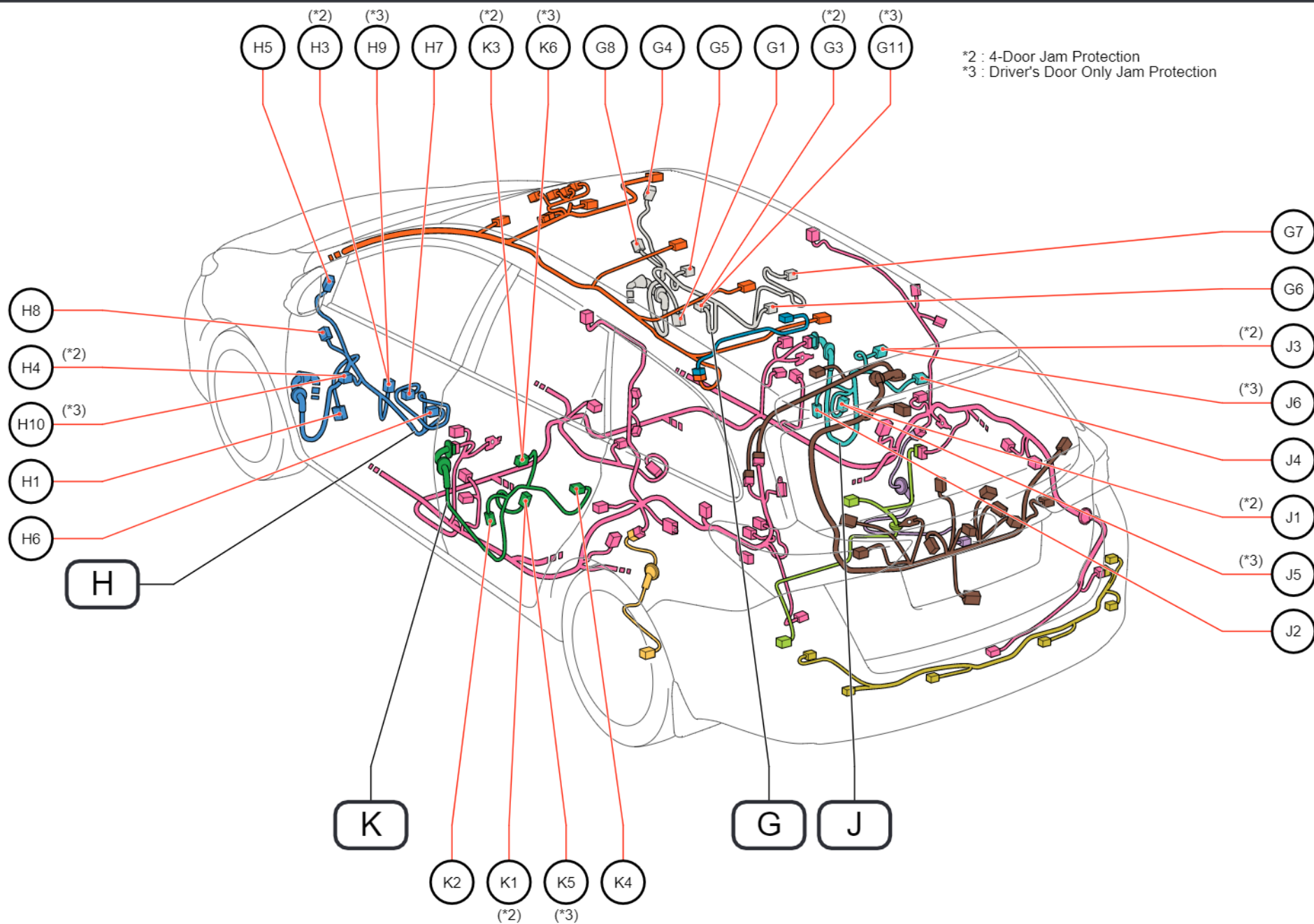

Position of Parts in Body <RHD W/G>

---

- G 1 Front No. 1 Speaker Assembly RH
- G 3 Power Window Regulator Master Switch Assembly
- G 4 Front No. 2 Speaker Assembly RH
- G 5 Front Power Window Regulator Motor Assembly RH
- G 6 Front Door Lock Assembly RH
- G 7 Front Door Outside Handle Assembly RH
- G 8 Outer Rear View Mirror Assembly RH
- G 11 Power Window Regulator Master Switch Assembly
  
- H 1 Front No. 1 Speaker Assembly LH
- H 3 Front Power Window Regulator Switch Assembly LH
- H 4 Front Power Window Regulator Motor Assembly LH
- H 5 Front No. 2 Speaker Assembly LH
- H 6 Front Door Lock Assembly LH
- H 7 Front Door Outside Handle Assembly LH
- H 8 Outer Rear View Mirror Assembly LH
- H 9 Front Power Window Regulator Switch Assembly LH
- H 10 Power Window Regulator Motor Assembly LH
  
- J 1 Rear Power Window Regulator Switch Assembly RH
- J 2 Rear Speaker Assembly RH
- J 3 Rear Power Window Regulator Motor Assembly RH
- J 4 Rear Door Lock Assembly RH
- J 5 Rear Power Window Regulator Switch Assembly RH
- J 6 Rear Power Window Regulator Motor Assembly RH
  
- K 1 Rear Power Window Regulator Switch Assembly LH
- K 2 Rear Speaker Assembly LH
- K 3 Rear Power Window Regulator Motor Assembly LH
- K 4 Rear Door Lock Assembly LH
- K 5 Rear Power Window Regulator Switch Assembly LH
- K 6 Rear Power Window Regulator Motor Assembly LH

Position of Parts in Body <RHD W/G>



90980-10935

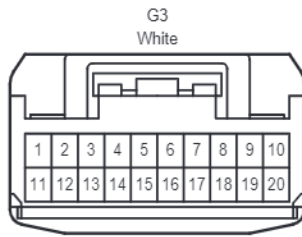

90980-12460

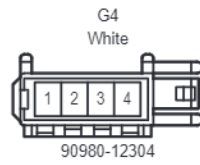

90980-12304

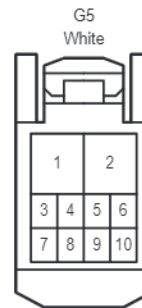

90980-12328



90980-12226

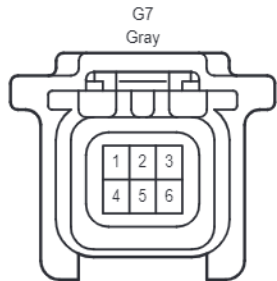

90980-12790

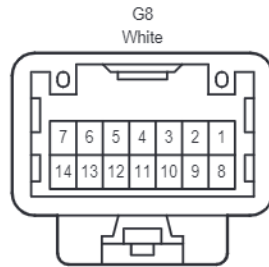

90980-12369

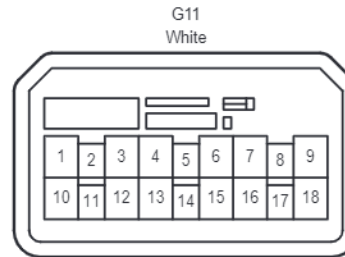

90980-12122



90980-10935

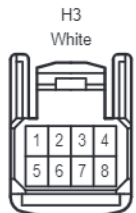

90980-12551

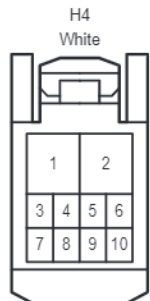

90980-12328



90980-12304

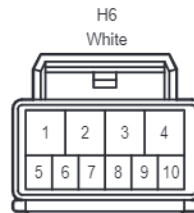

90980-12226

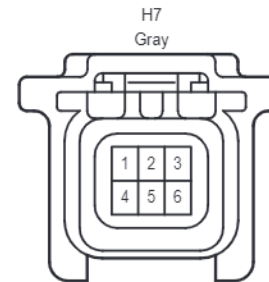

90980-12790

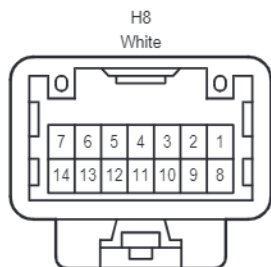

90980-12369



90980-10789

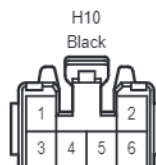

90980-10797



90980-12551



90980-10935

cardiagn.com

Position of Parts in Body <RHD W/G>

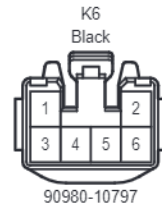
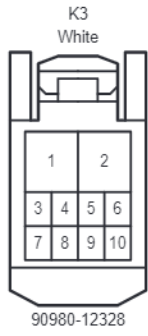
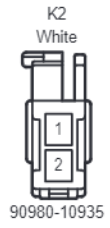

Position of Parts in Body <RHD W/G>

\*1 : Refer to the Service Bulletin  
for the installation position of the parts.

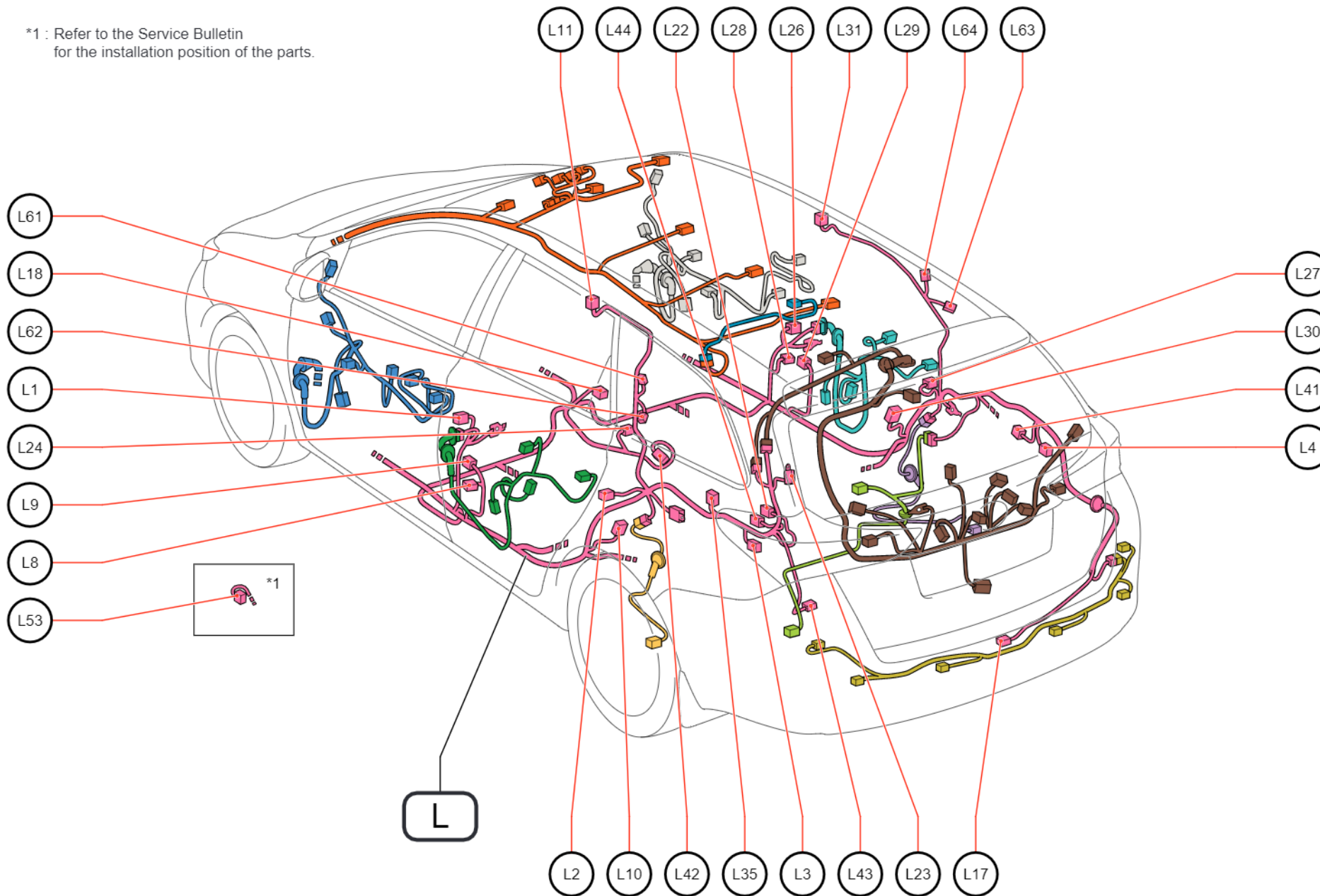

Position of Parts in Body <RHD W/G>

---

- L 1 Front Door Courtesy Light Switch Assembly LH
- L 2 Rear Door Courtesy Light Switch Assembly LH
- L 3 Rear Combination Light Assembly LH
- L 4 Rear Combination Light Assembly RH
- L 8 Front Seat Outer Belt Assembly LH
- L 9 Side Airbag Sensor Assembly LH
- L 10 Rear Side Airbag Sensor LH
- L 11 Curtain Shield Airbag Assembly LH
- L 17 Rear Electrical Key Antenna
- L 18 Parking Brake Switch Assembly
- L 22 No. 1 Luggage Compartment Light Assembly
- L 23 Noise Filter (Radio Setting Condenser)
- L 24 No. 3 Indoor Electrical Key Antenna Assembly
- L 26 Front Door Courtesy Light Switch Assembly RH
- L 27 Rear Door Courtesy Light Switch Assembly RH
- L 28 Front Seat Outer Belt Assembly RH
- L 29 Side Airbag Sensor Assembly RH
- L 30 Rear Side Airbag Sensor RH
- L 31 Curtain Shield Airbag Assembly RH
- L 35 Door Control Receiver
- L 41 No. 2 Clearance Warning Buzzer
- L 42 No. 2 Power Outlet Socket Assembly
- L 43 Rear No. 1 Power Outlet Socket Assembly
- L 44 No. 1 Speaker with Box Assembly
- L 53 Theft Warning Siren Assembly
- L 61 Glass Breakage Sensor (+) (Quarter Window Assembly LH)
- L 62 Glass Breakage Sensor (-) (Quarter Window Assembly LH)
- L 63 Glass Breakage Sensor (+) (Quarter Window Assembly RH)
- L 64 Glass Breakage Sensor (-) (Quarter Window Assembly RH)

Position of Parts in Body <RHD W/G>

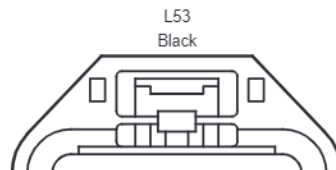
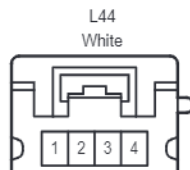
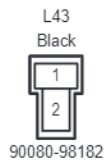
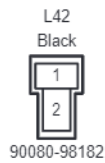
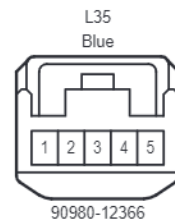
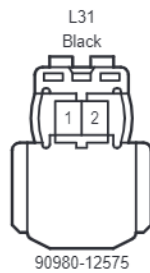
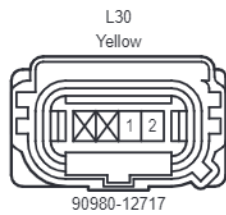
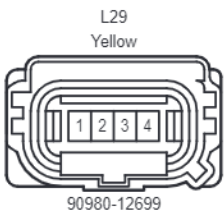
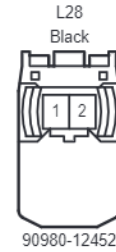
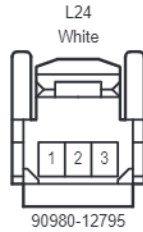
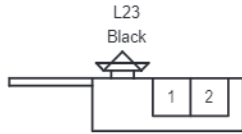
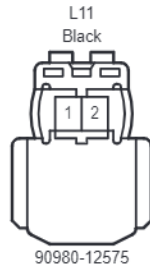
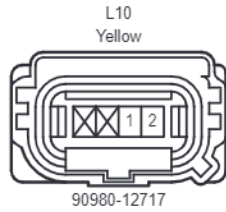
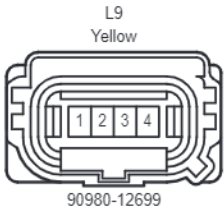
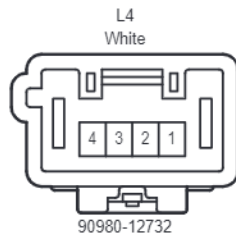
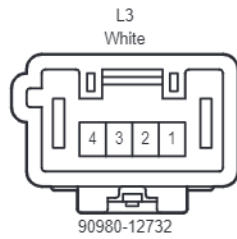

cardiagn.com



Position of Parts in Body <RHD W/G>

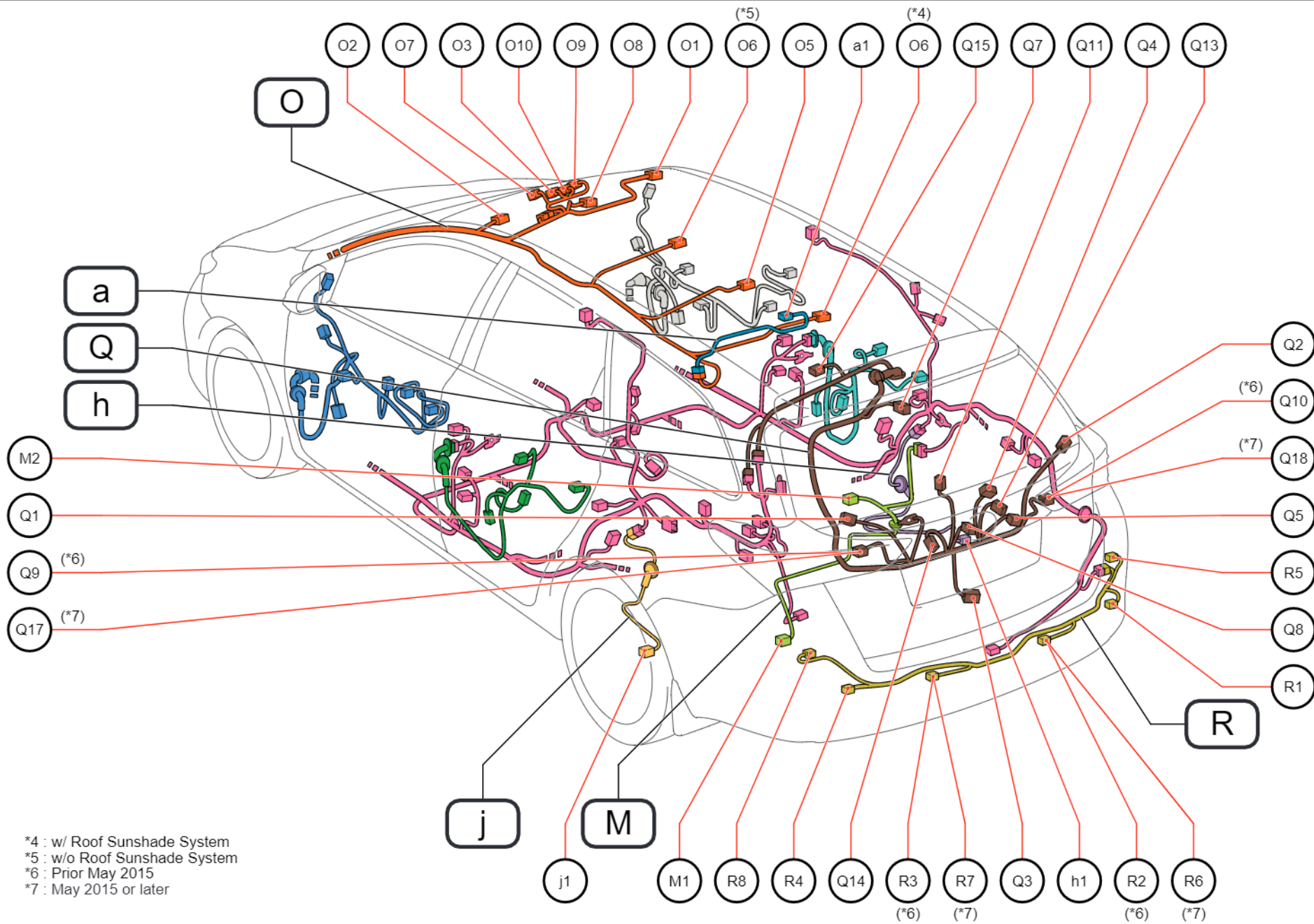

\*4 : w/ Roof Sunshade System  
 \*5 : w/o Roof Sunshade System  
 \*6 : Prior May 2015  
 \*7 : May 2015 or later

Position of Parts in Body <RHD W/G>

---

- M 1 Rear Height Control Sensor Sub-Assembly
- M 2 No. 1 Indoor Electrical Key Antenna Assembly

- O 1 Vanity Light Assembly RH
- O 2 Vanity Light Assembly LH
- O 3 Inner Rear View Mirror Assembly
- O 5 Rear Room Light (No. 1 Room Light Assembly)
- O 6 Dome Light (No. 1 Room Light Assembly)
- O 7 Rain Sensor
- O 8 Map Light Assembly
- O 9 Precrash Safety City Sensor
- O 10 Precrash Safety City Heater

- Q 1 Rear Window Defogger (Back Door Glass)
- Q 2 Rear Window Defogger (Back Door Glass)
- Q 3 Back Door Lock Assembly
- Q 4 Rear Wiper Motor Assembly
- Q 5 Rear Television Camera Assembly
- Q 7 Center Stop Light Assembly
- Q 8 Back Door Opener Switch Assembly
- Q 9 Rear Light Assembly LH
- Q 10 Rear Light Assembly RH
- Q 11 Glass Breakage Sensor (Back Door Glass)
- Q 13 License Plate Light Assembly RH
- Q 14 License Plate Light Assembly LH
- Q 15 Tire Pressure Monitor Receiver Assembly
- Q 17 Rear Light Assembly LH
- Q 18 Rear Light Assembly RH

- R 1 Rear No. 1 Ultrasonic Sensor RH
- R 2 Rear No. 1 Ultrasonic Sensor Center RH
- R 3 Rear No. 1 Ultrasonic Sensor Center LH
- R 4 Rear No. 1 Ultrasonic Sensor LH
- R 5 Rear No. 1 Ultrasonic Sensor RH
- R 6 Rear No. 1 Ultrasonic Sensor Center RH
- R 7 Rear No. 1 Ultrasonic Sensor Center LH
- R 8 Rear No. 1 Ultrasonic Sensor LH

- a 1 Sliding Roof Drive Gear Assembly

- h 1 Rear Speed Sensor RH

Position of Parts in Body <RHD W/G>

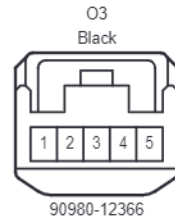
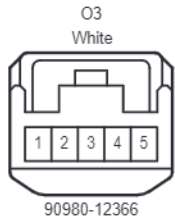
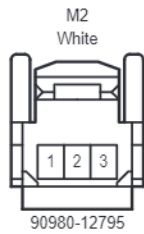
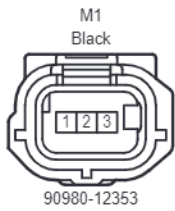

(Except November 2016 or later w/ Precrash System)

(November 2016 or later w/ Precrash System)

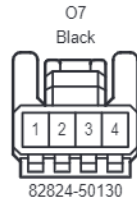
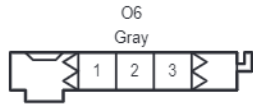

(Except November 2016 or later w/ Precrash System)

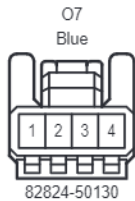

(November 2016 or later w/ Precrash System)

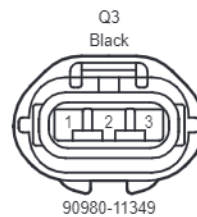
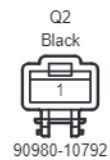
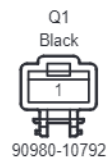
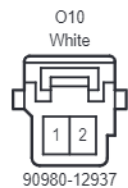
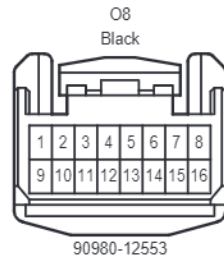

Position of Parts in Body <RHD W/G>

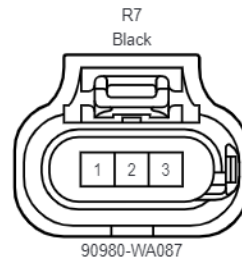
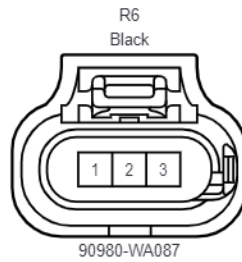
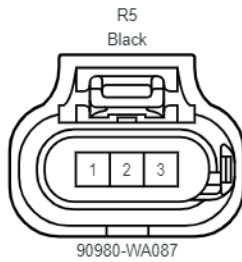
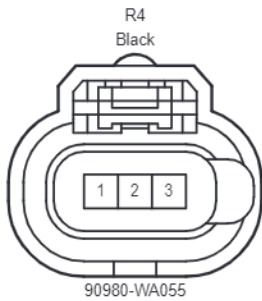
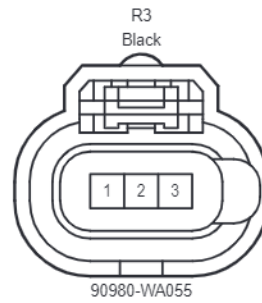
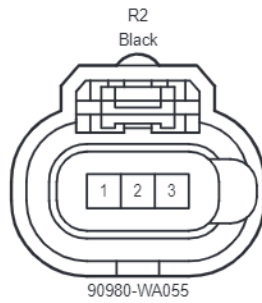
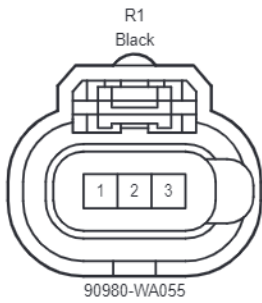
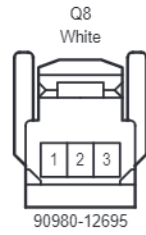
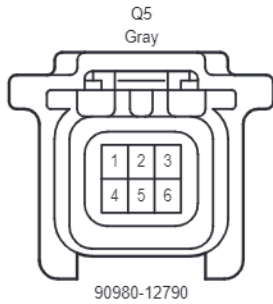

cardiagn.com



- \*1 : Prior May 2014
- \*2 : May 2014 or later
- \*3 : Prior May 2015
- \*4 : May 2015 or later

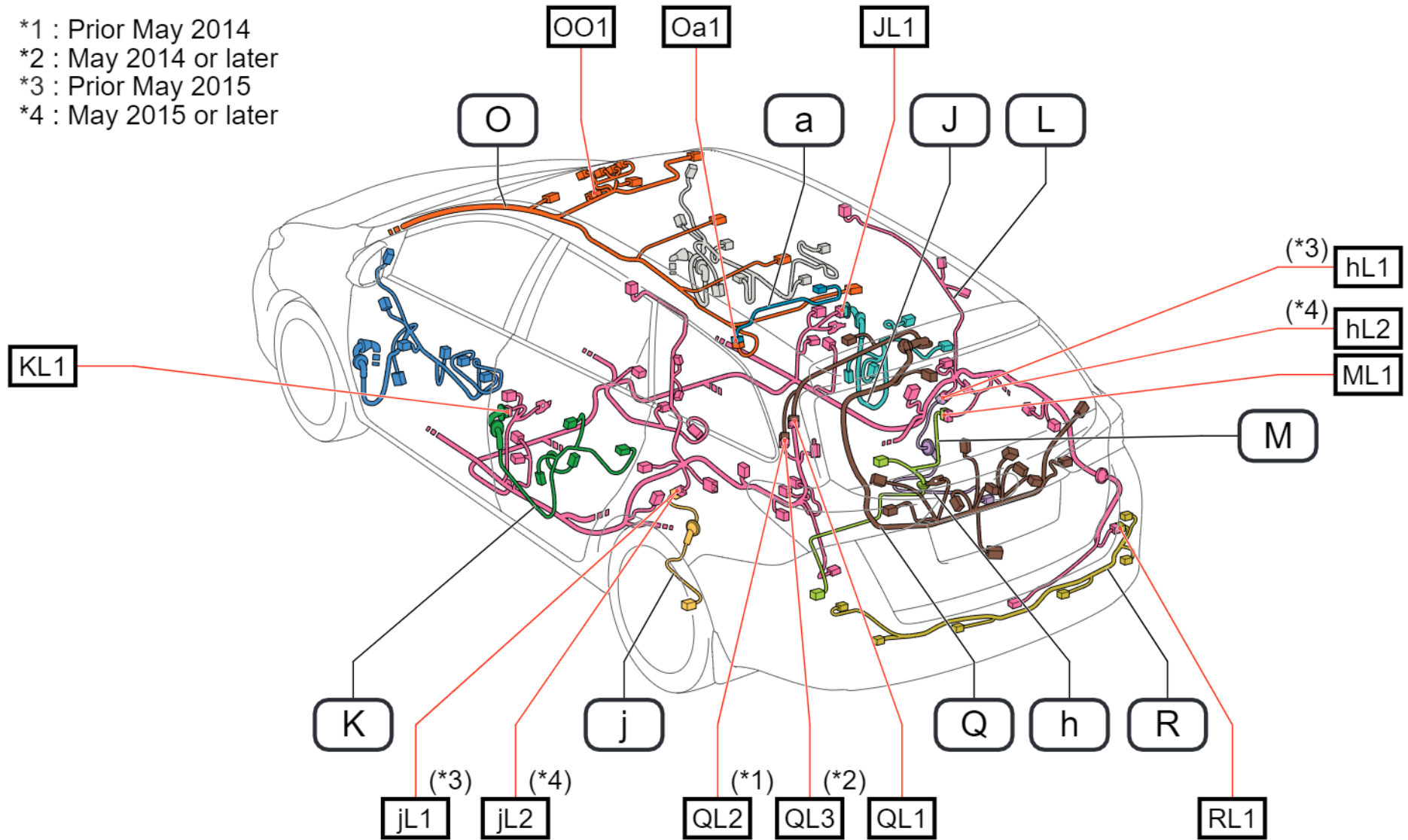

Wire and Wire in Body <RHD W/G>

JL1  
White

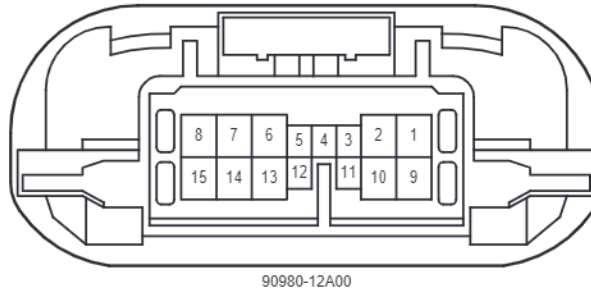
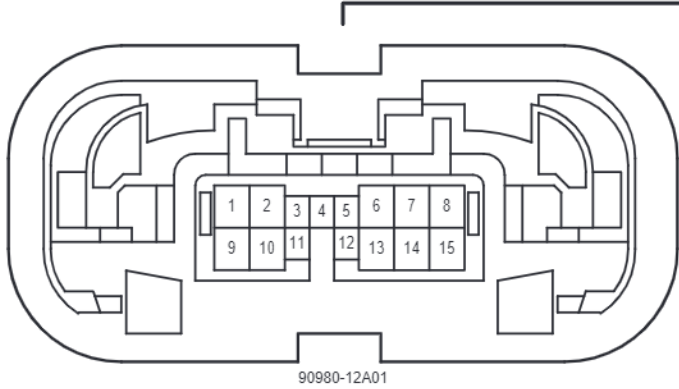

KL1  
White

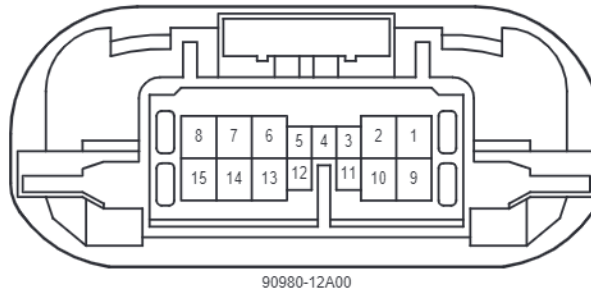
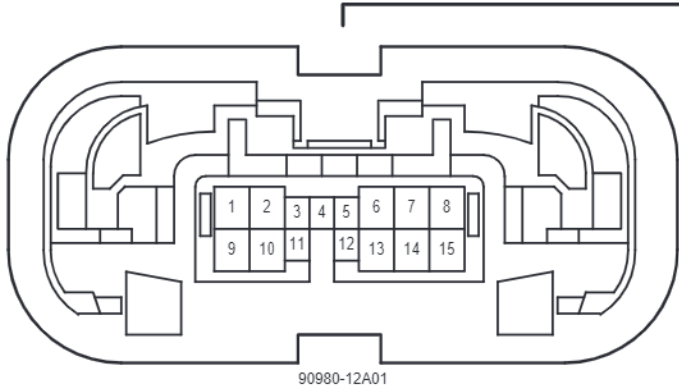

ML1  
White

OO1  
Gray

Oa1  
White

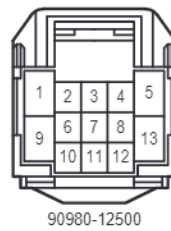
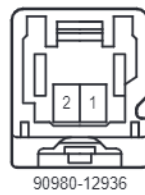
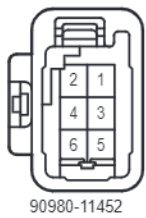
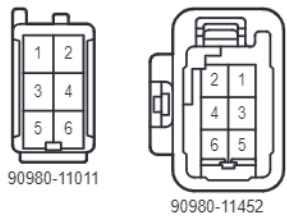

QL1  
White

QL2  
White

cardiagn.com

Wire and Wire in Body <RHD W/G>

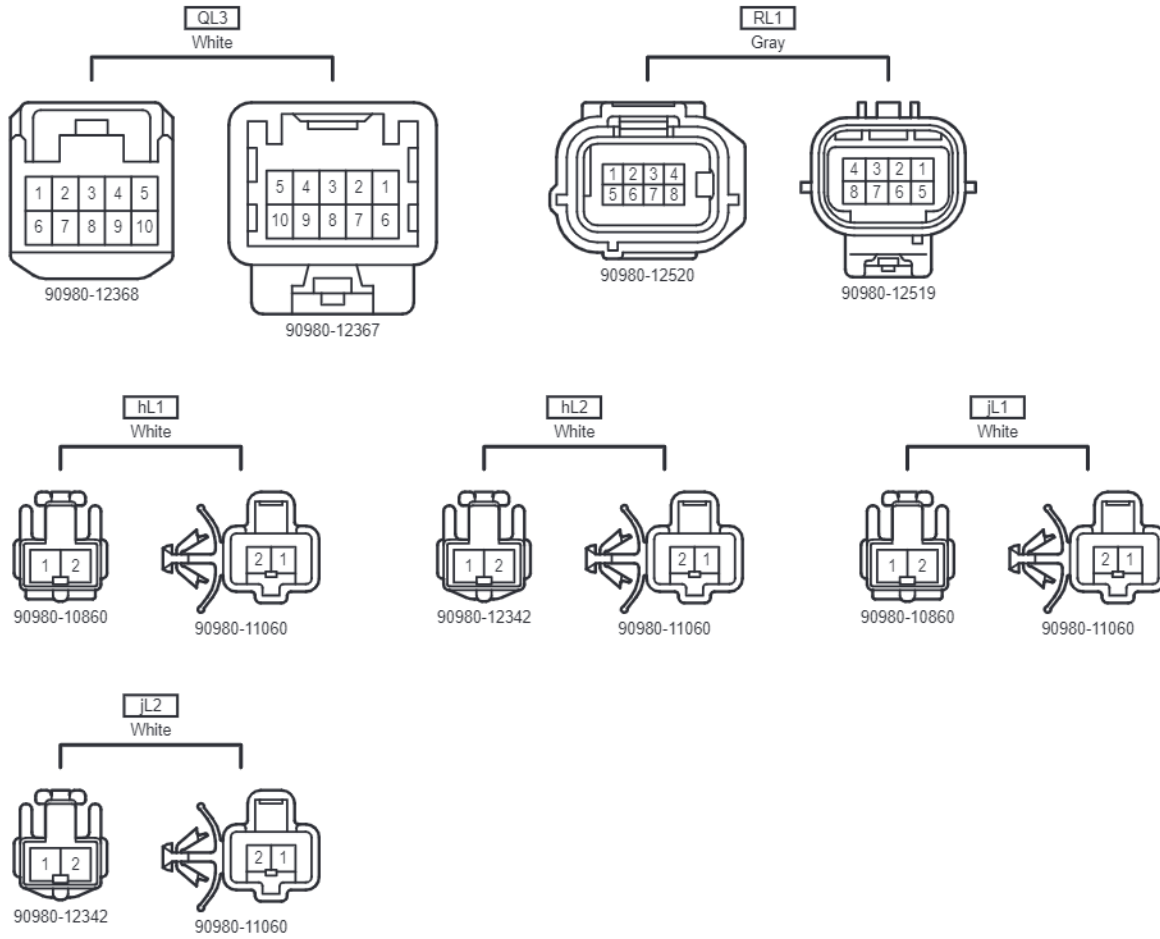

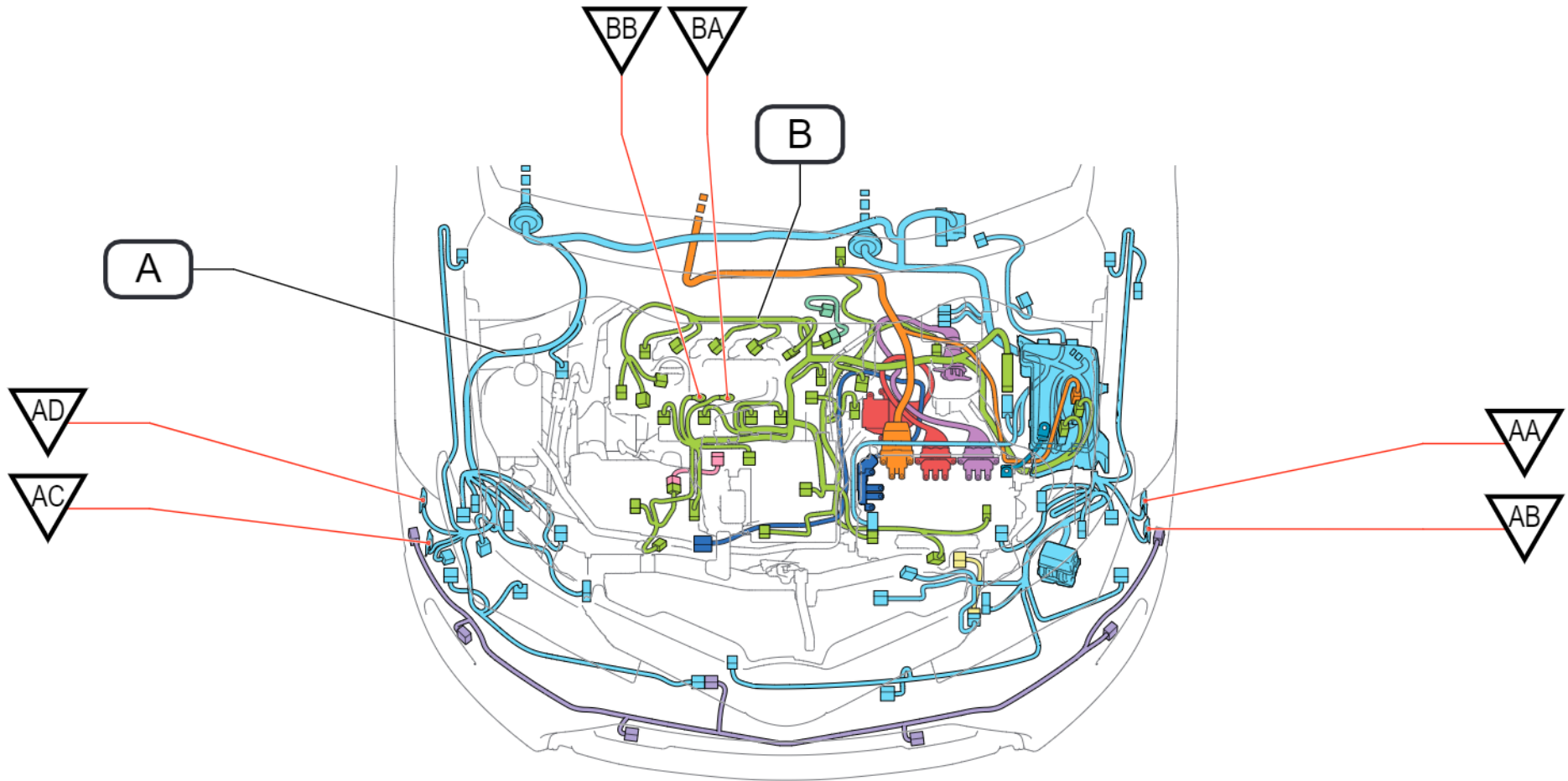



Position of Parts in Engine Compartment <LHD>

\*1 : Halogen Type  
 \*2 : HID Type

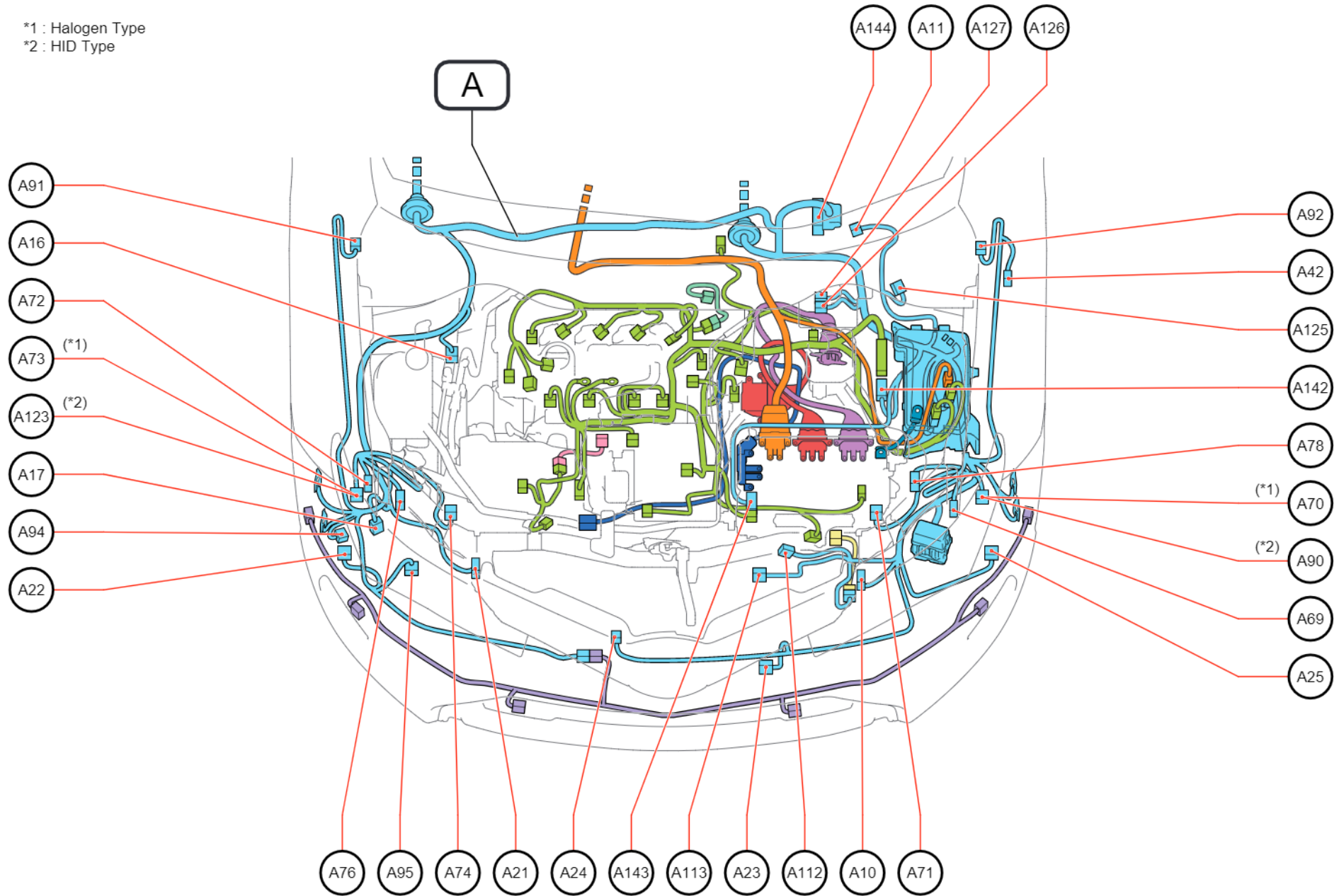

Position of Parts in Engine Compartment <LHD>

---

- A 10 Front Airbag Sensor LH
- A 11 Windshield Wiper Motor Assembly
- A 16 A/C Pressure Sensor (Air Conditioner Tube & Accessory Assembly)
- A 17 Windshield Washer Motor and Pump Assembly
- A 21 Front Airbag Sensor RH
- A 22 Fog Light Assembly RH
- A 23 Ambient Temperature Sensor (Thermistor Assembly)
- A 24 High Pitched Horn Assembly
- A 25 Fog Light Assembly LH
- A 42 Wireless Door Lock Buzzer
- A 69 Headlight Assembly LH
- A 70 Headlight Assembly LH
- A 71 Headlight Assembly LH
- A 72 Headlight Assembly RH
- A 73 Headlight Assembly RH
- A 74 Headlight Assembly RH
- A 76 Headlight Assembly RH
- A 78 Headlight Assembly LH
- A 90 Headlight Assembly LH
- A 91 Front Speed Sensor RH
- A 92 Front Speed Sensor LH
- A 94 Headlight Cleaner Control Relay
- A 95 Headlight Cleaner Washer Motor and Pump Assembly
- A 112 Cooling Fan Motor
- A 113 No. 2 Cooling Fan Motor
- A 123 Headlight Assembly RH
- A 125 Brake Fluid Level Warning Switch (Brake Master Cylinder Reservoir Assembly)
- A 126 Brake Booster Pump Assembly
- A 127 Brake Booster Pump Assembly
- A 142 ECM
- A 143 Inverter with Converter Assembly
- A 144 Brake Actuator Assembly (Brake Booster with Master Cylinder Assembly)

Position of Parts in Engine Compartment <LHD>

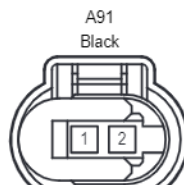
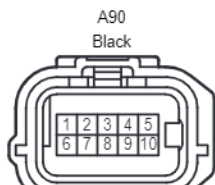
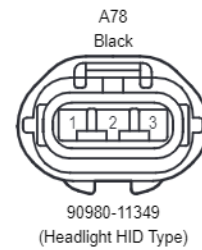
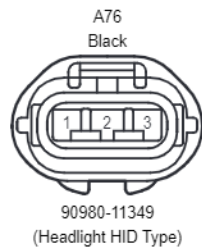
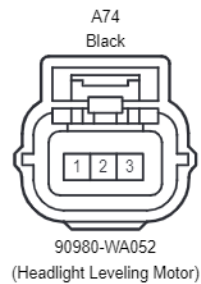
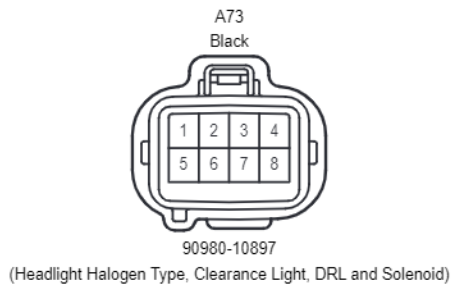
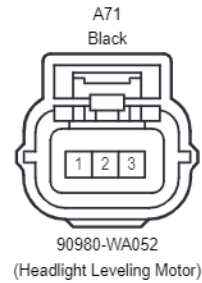
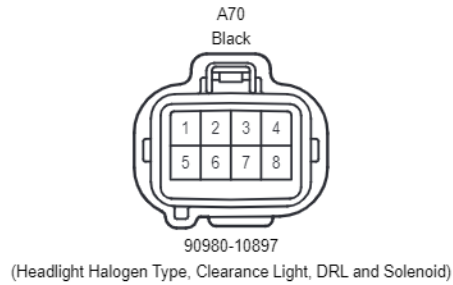
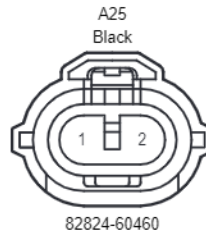
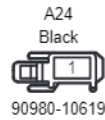
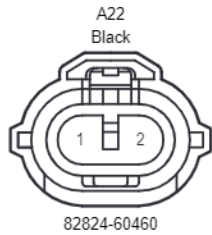
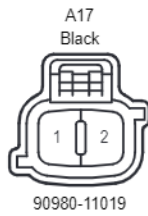
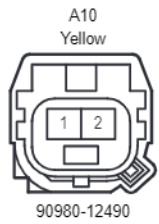

Position of Parts in Engine Compartment <LHD>

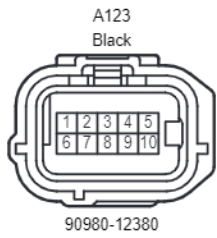
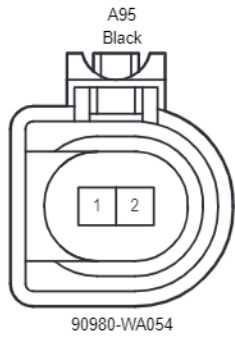

(Headlight HID Type, Clearance Light, DRL, Headlight Swivel Motor and Solenoid)

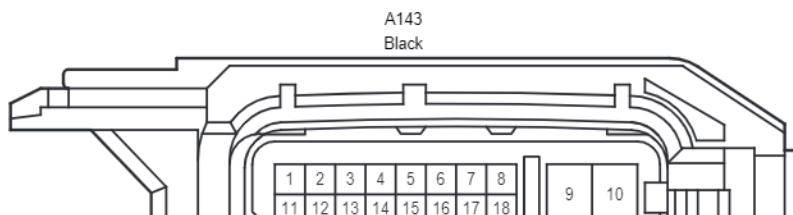
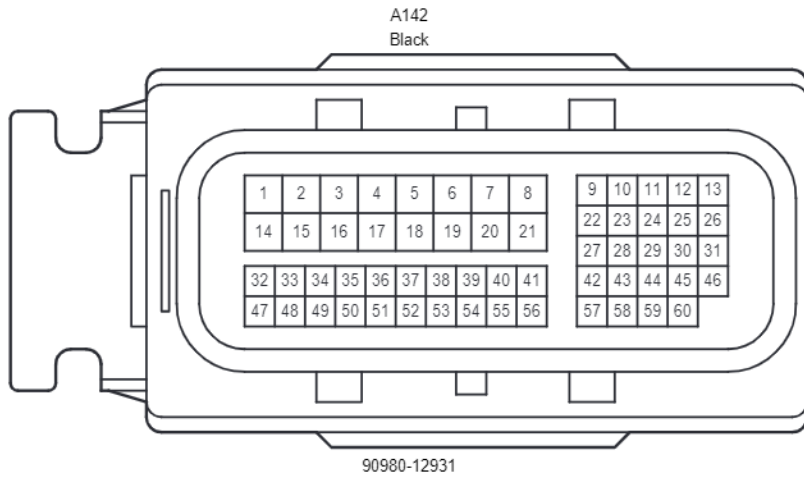
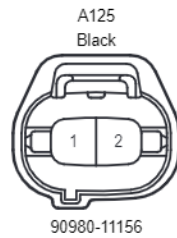

Position of Parts in Engine Compartment <LHD>

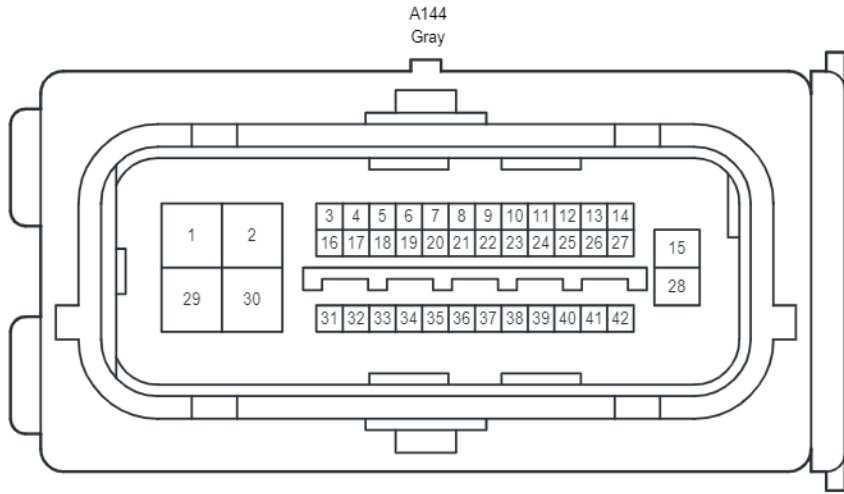

90980-12828

Position of Parts in Engine Compartment <LHD>

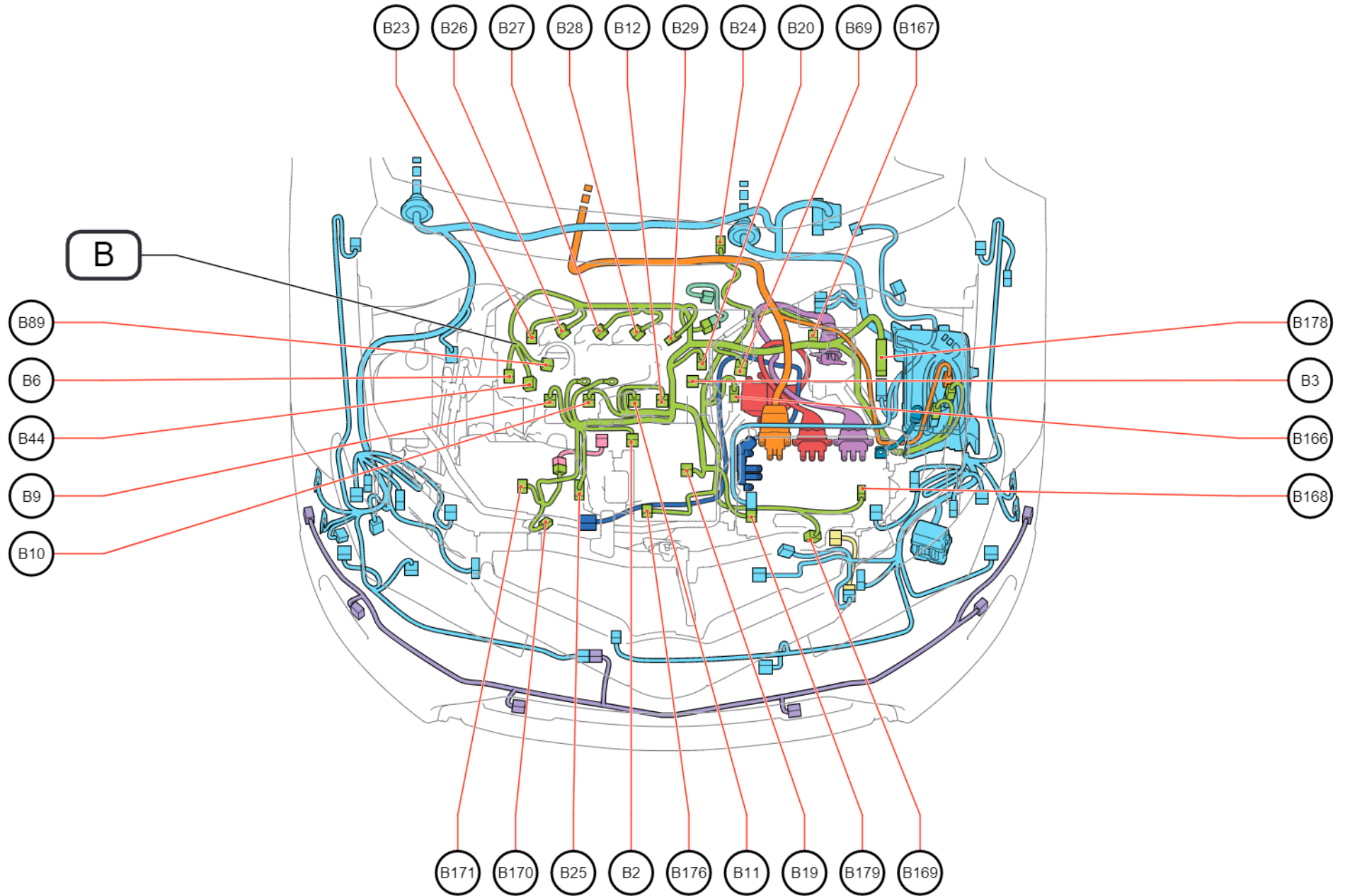

Position of Parts in Engine Compartment <LHD>

---

- B 2 Intake Mass Air Flow Meter Sub-Assembly
- B 3 E.F.I. Engine Coolant Temperature Sensor
- B 6 Engine Oil Pressure Switch Assembly
- B 9 Fuel Injector Assembly No. 1
- B 10 Fuel Injector Assembly No. 2
- B 11 Fuel Injector Assembly No. 3
- B 12 Fuel Injector Assembly No. 4
- B 19 Purge VSV (Vacuum Switching Valve Assembly)
- B 20 VVT Sensor (Intake Side)
- B 23 Camshaft Timing Oil Control Valve Assembly (Intake Side)
- B 24 Oxygen Sensor (Bank 1 Sensor 2)
- B 25 Throttle Body Assembly
- B 26 Ignition Coil Assembly No. 1
- B 27 Ignition Coil Assembly No. 2
- B 28 Ignition Coil Assembly No. 3
- B 29 Ignition Coil Assembly No. 4
- B 44 Crank Position Sensor
- B 69 EGR Valve Assembly
- B 89 Air Fuel Ratio Sensor (Bank 1 Sensor 1)
- B 166 Hybrid Vehicle Generator Assembly
- B 167 Hybrid Vehicle Generator Assembly
- B 168 Hybrid Vehicle Generator Assembly
- B 169 Shift Control Actuator Assembly
- B 170 Compressor with Motor Assembly
- B 171 Engine Water Pump Assembly
- B 176 E.F.I. Vacuum Sensor Assembly
- B 178 ECM
- B 179 Inverter with Converter Assembly

Position of Parts in Engine Compartment <LHD>

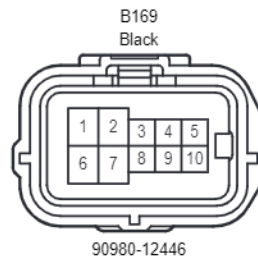
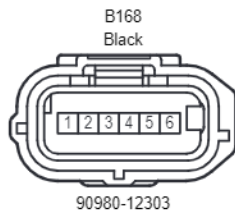
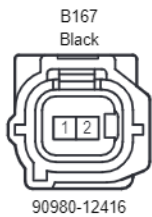
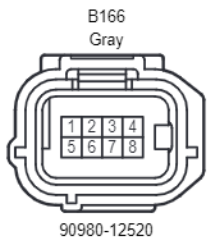
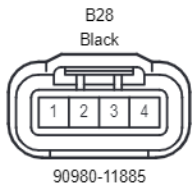
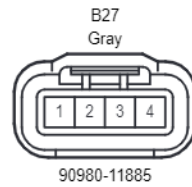
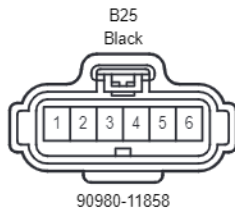
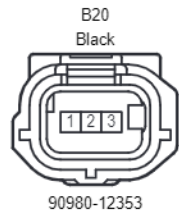
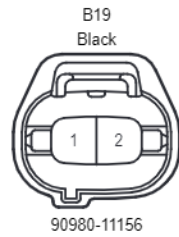
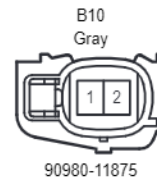
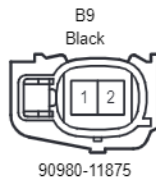
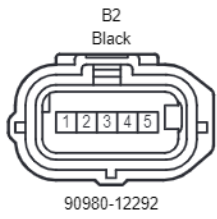



Position of Parts in Engine Compartment <LHD>

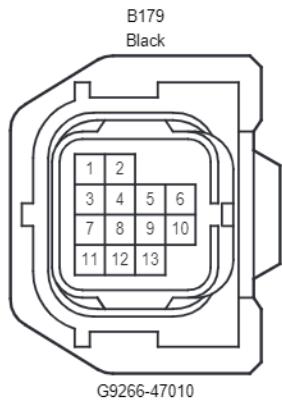
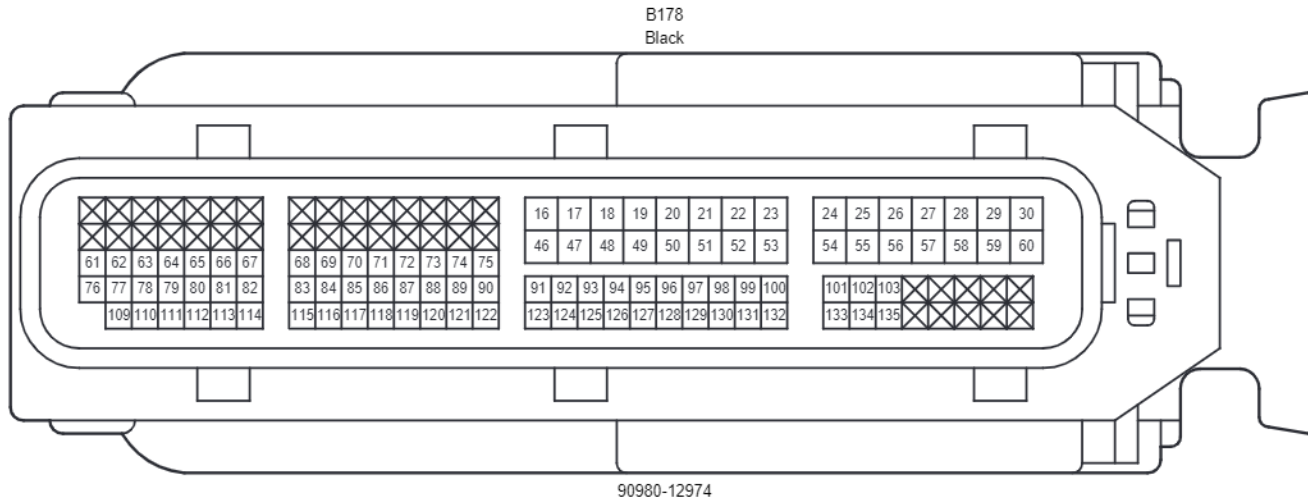

Position of Parts in Engine Compartment <LHD>

\*3 : Prior Jun. 2013  
 \*4 : From Jun. 2013 or later

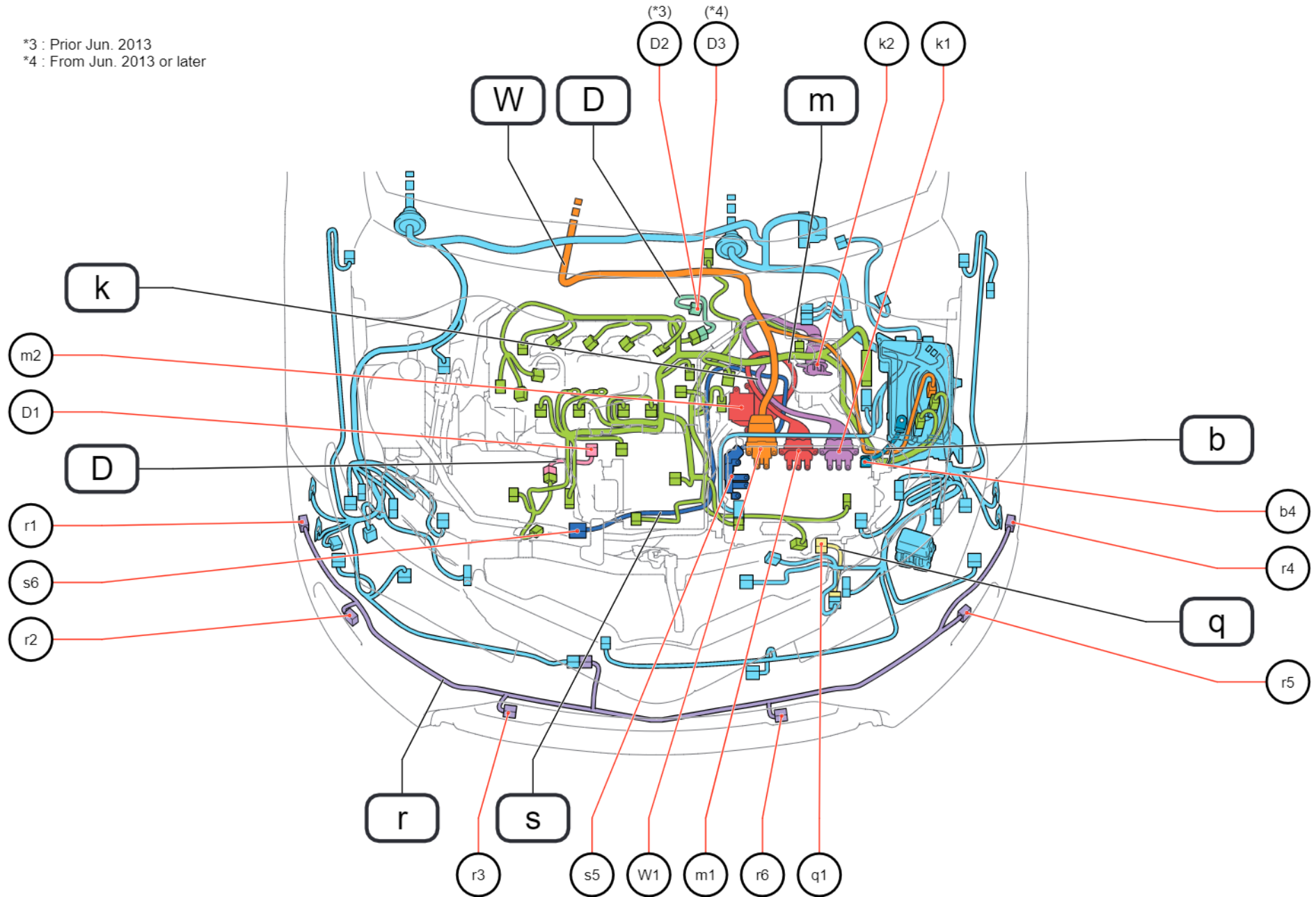

Position of Parts in Engine Compartment <LHD>

---

- D 1 Knock Control Sensor (Bank 1)
- D 2 Engine Coolant Temperature Sensor
- D 3 Engine Coolant Temperature Sensor

W 1 Inverter with Converter Assembly

b 4 Inverter with Converter Assembly

- k 1 Inverter with Converter Assembly
- k 2 Hybrid Vehicle Generator Assembly

- m 1 Inverter with Converter Assembly
- m 2 Hybrid Vehicle Generator Assembly

q 1 Water Pump with Motor Assembly

- r 1 Front No. 1 Ultrasonic Sensor RH Side
- r 2 Front No. 1 Ultrasonic Sensor RH
- r 3 Front No. 1 Ultrasonic Sensor RH Center
- r 4 Front No. 1 Ultrasonic Sensor LH Side
- r 5 Front No. 1 Ultrasonic Sensor LH
- r 6 Front No. 1 Ultrasonic Sensor LH Center

- s 5 Compressor with Motor Assembly
- s 6 Inverter with Converter Assembly

Position of Parts in Engine Compartment <LHD>

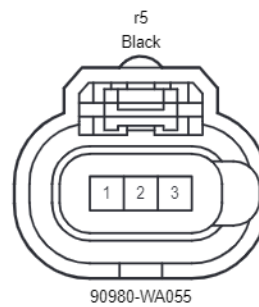
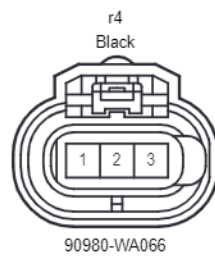
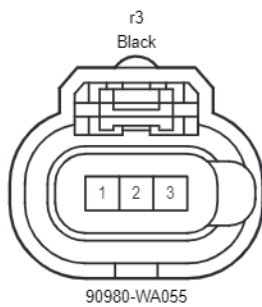
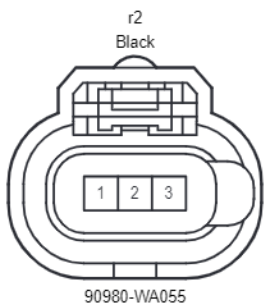
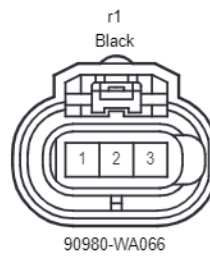
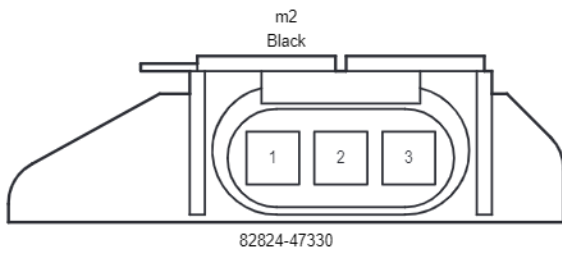
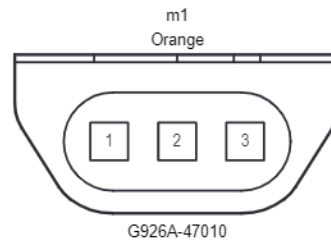
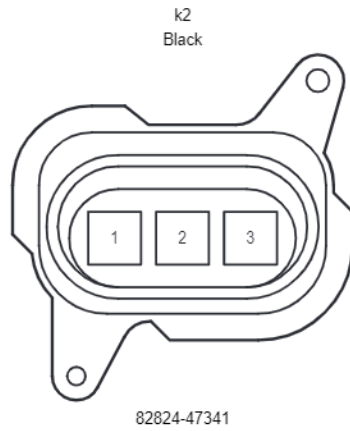
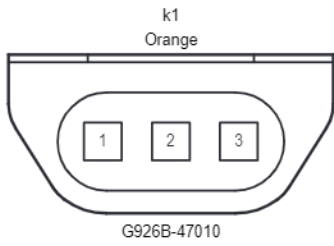
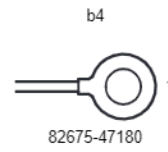
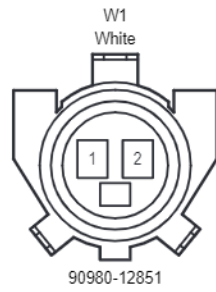
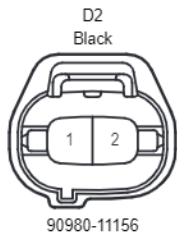

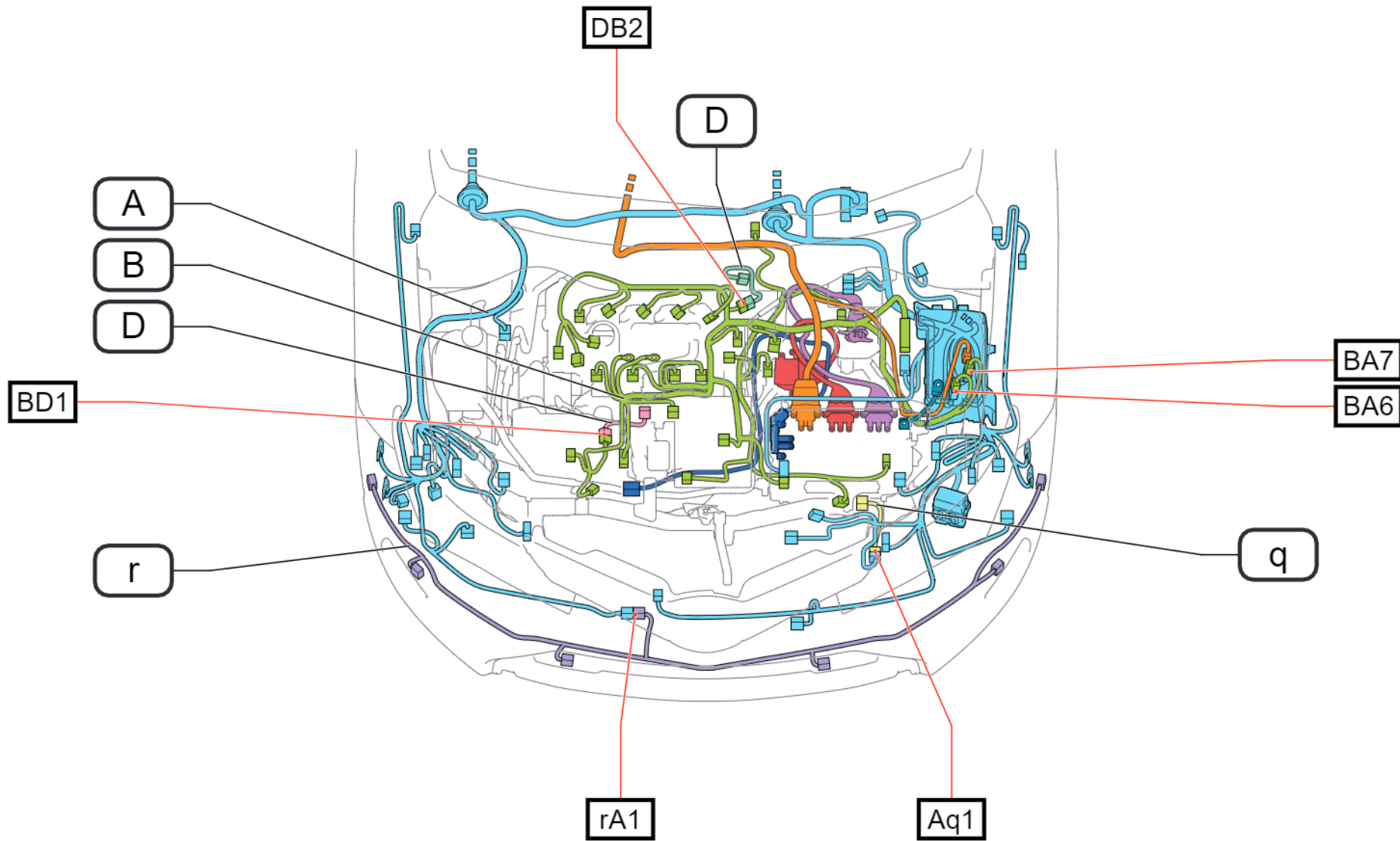

Wire and Wire in Engine Compartment <LHD>

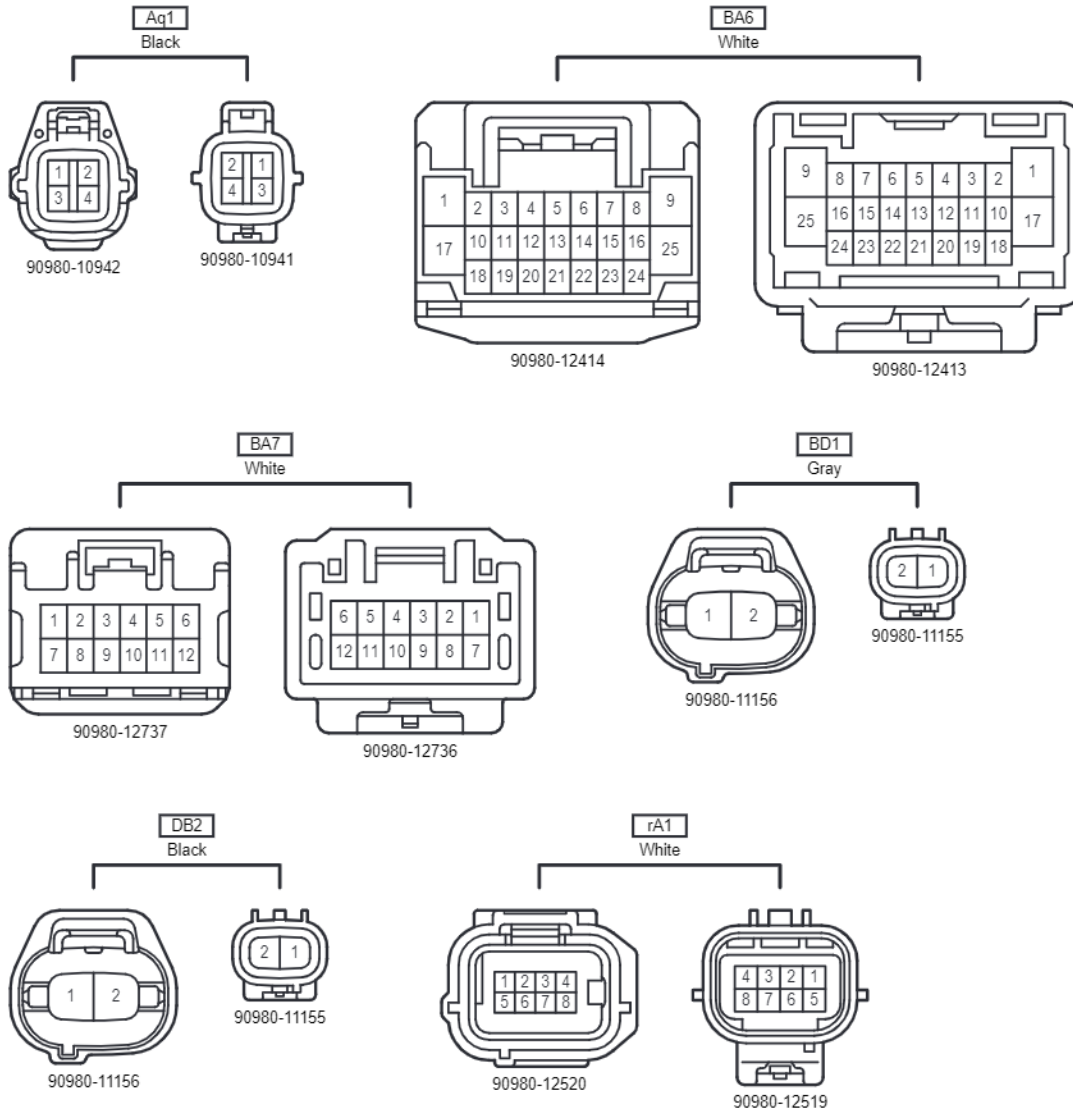

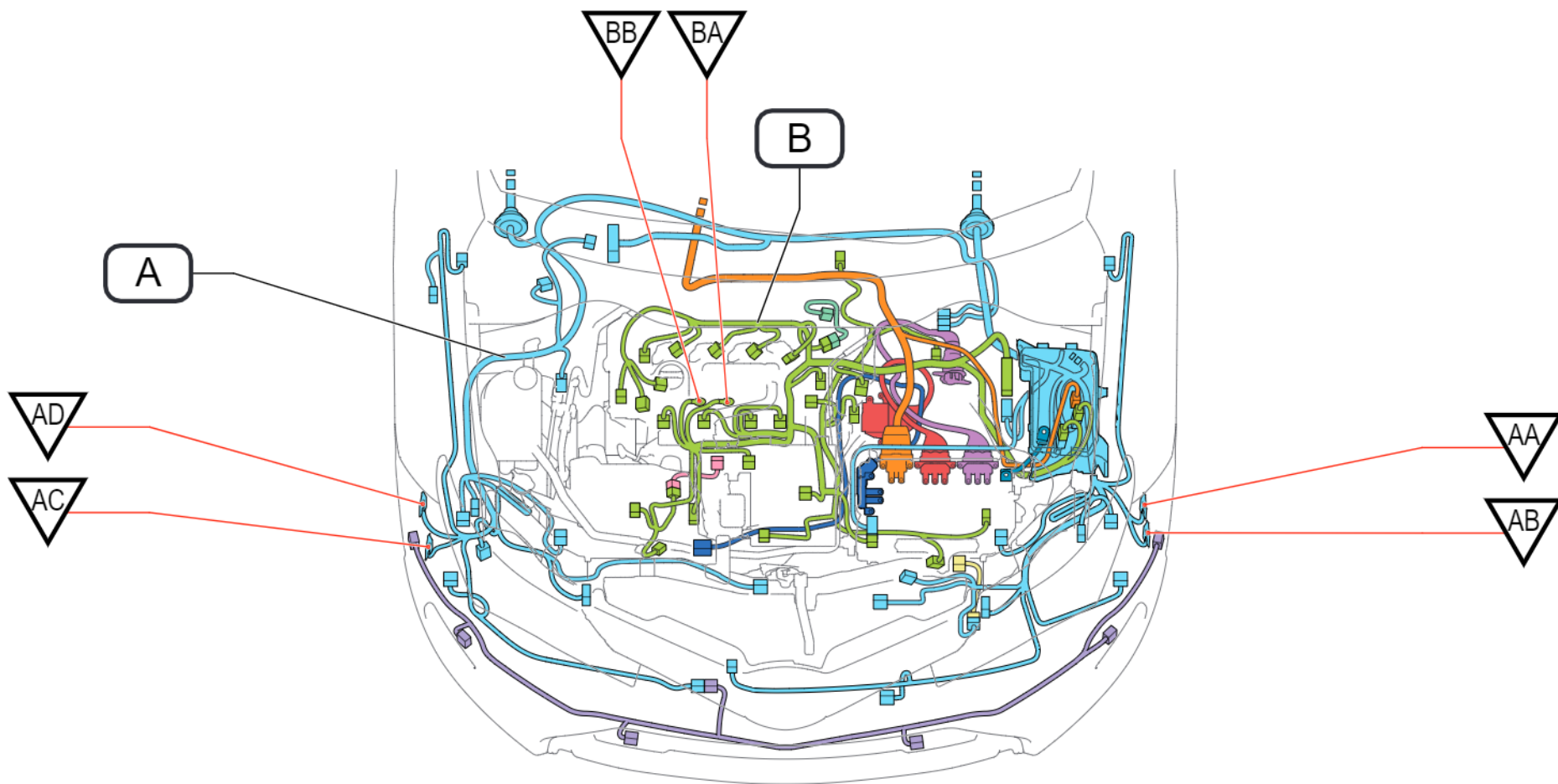

Position of Parts in Engine Compartment <RHD>

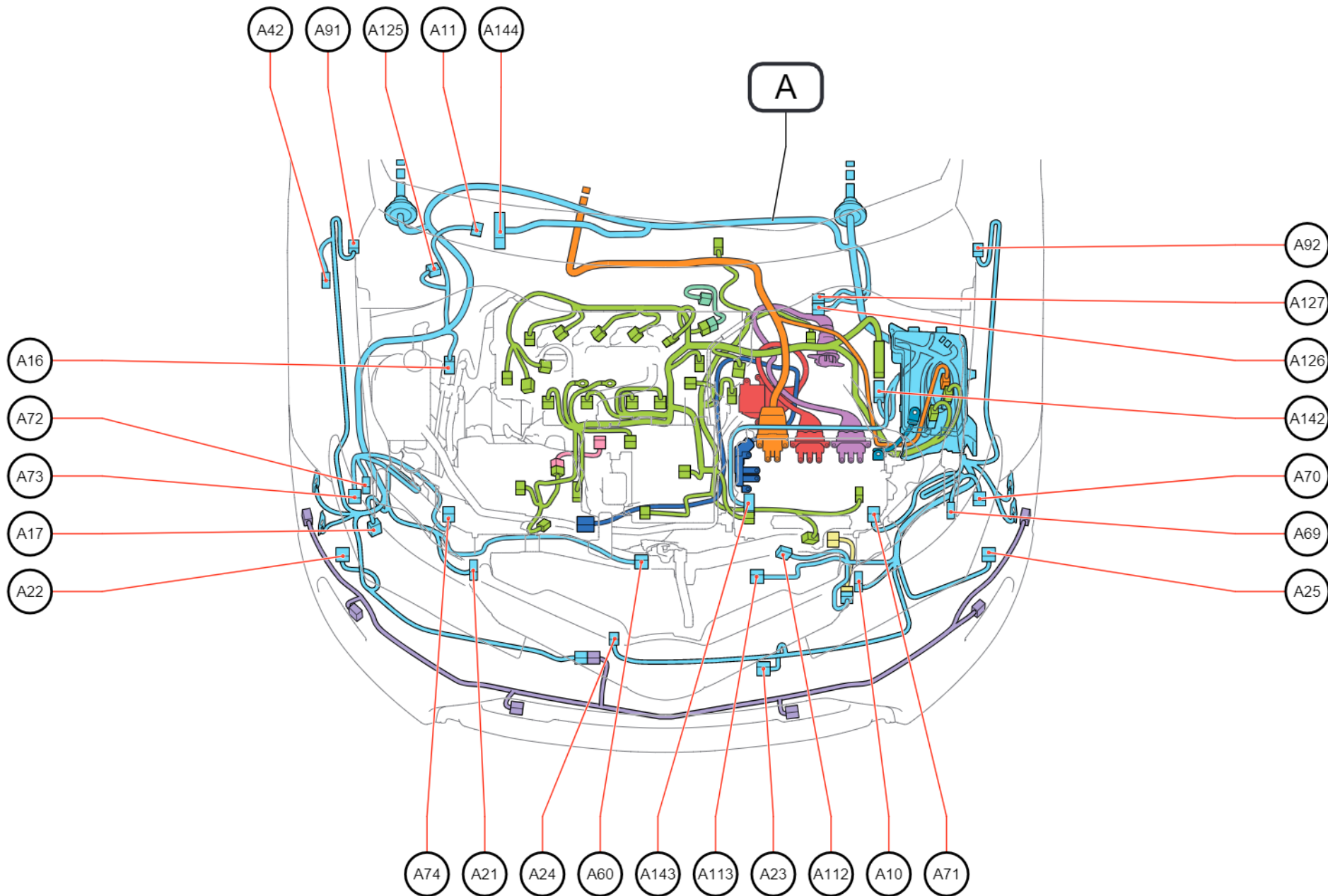



Position of Parts in Engine Compartment <RHD>

---

- A 10 Front Airbag Sensor LH
- A 11 Windshield Wiper Motor Assembly
- A 16 A/C Pressure Sensor (Air Conditioner Tube & Accessory Assembly)
- A 17 Windshield Washer Motor and Pump Assembly
- A 21 Front Airbag Sensor RH
- A 22 Fog Light Assembly RH
- A 23 Ambient Temperature Sensor (Thermistor Assembly)
- A 24 High Pitched Horn Assembly
- A 25 Fog Light Assembly LH
- A 42 Wireless Door Lock Buzzer
- A 60 Hood Courtesy Switch (Hood Lock Assembly)
- A 69 Headlight Assembly LH
- A 70 Headlight Assembly LH
- A 71 Headlight Assembly LH
- A 72 Headlight Assembly RH
- A 73 Headlight Assembly RH
- A 74 Headlight Assembly RH
- A 91 Front Speed Sensor RH
- A 92 Front Speed Sensor LH
- A 112 Cooling Fan Motor
- A 113 No. 2 Cooling Fan Motor
- A 125 Brake Fluid Level Warning Switch (Brake Master Cylinder Reservoir Assembly)
- A 126 Brake Booster Pump Assembly
- A 127 Brake Booster Pump Assembly
- A 142 ECM
- A 143 Inverter with Converter Assembly
- A 144 Brake Actuator Assembly (Brake Booster with Master Cylinder Assembly)

Position of Parts in Engine Compartment <RHD>

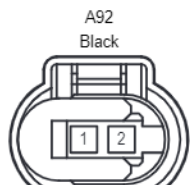
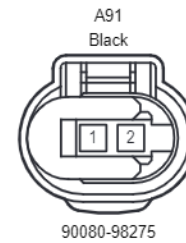
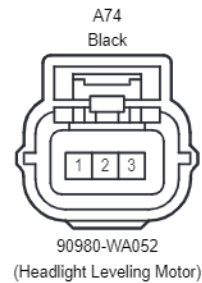
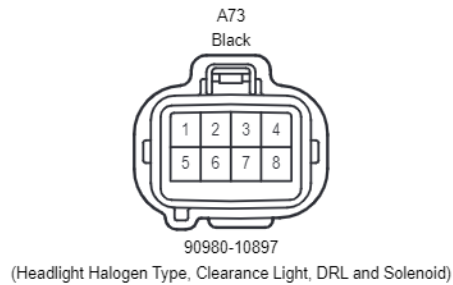
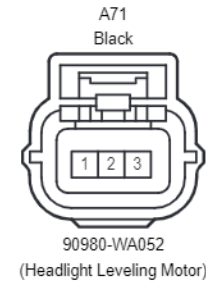
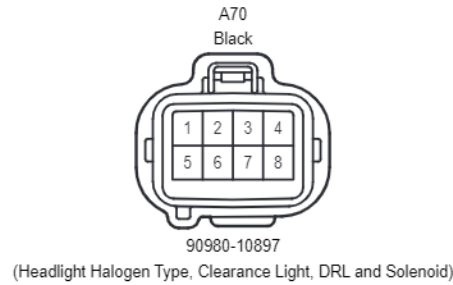
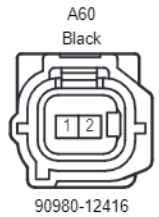
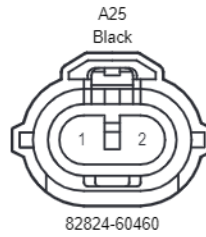
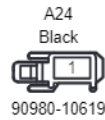
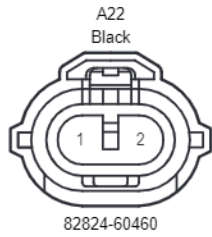
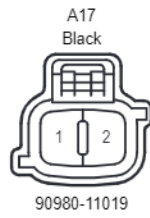
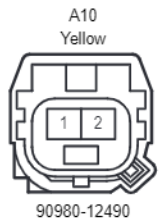

Position of Parts in Engine Compartment <RHD>

A142  
Black

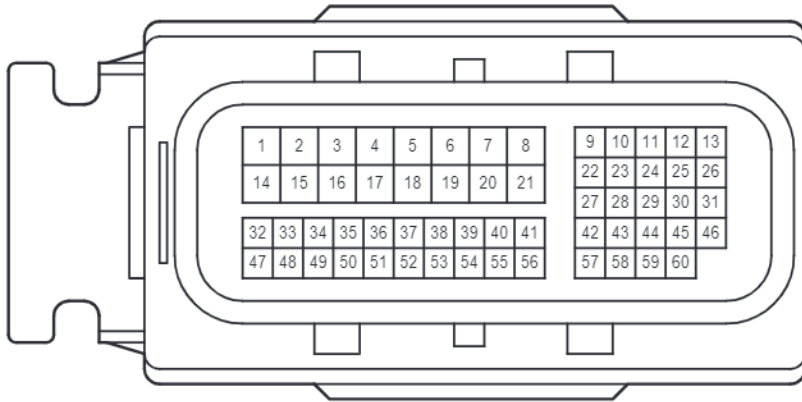

90980-12931

A143  
Black

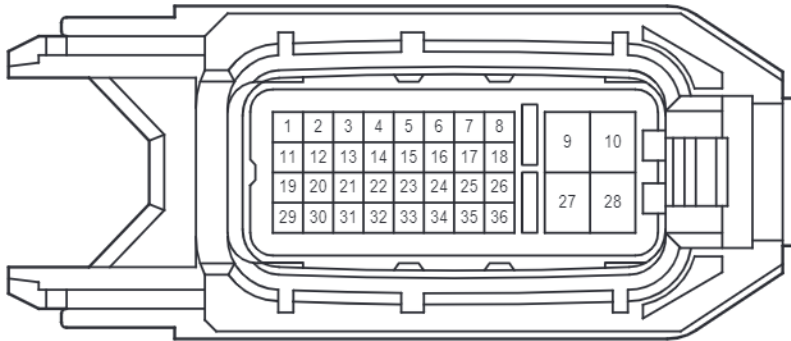

G9260-47010

A144  
Gray

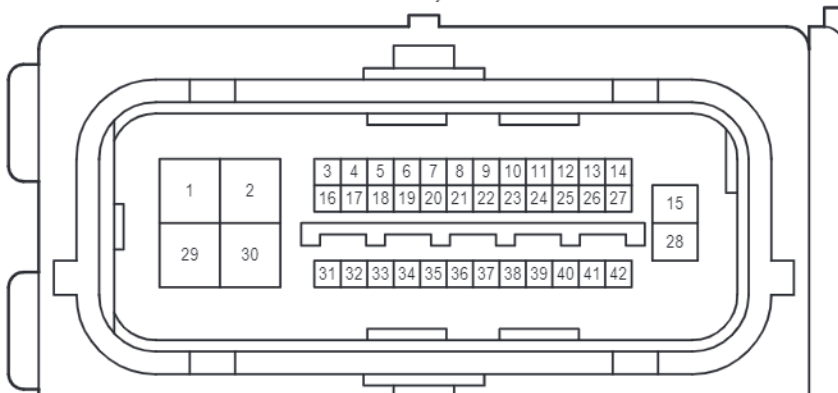

Position of Parts in Engine Compartment <RHD>

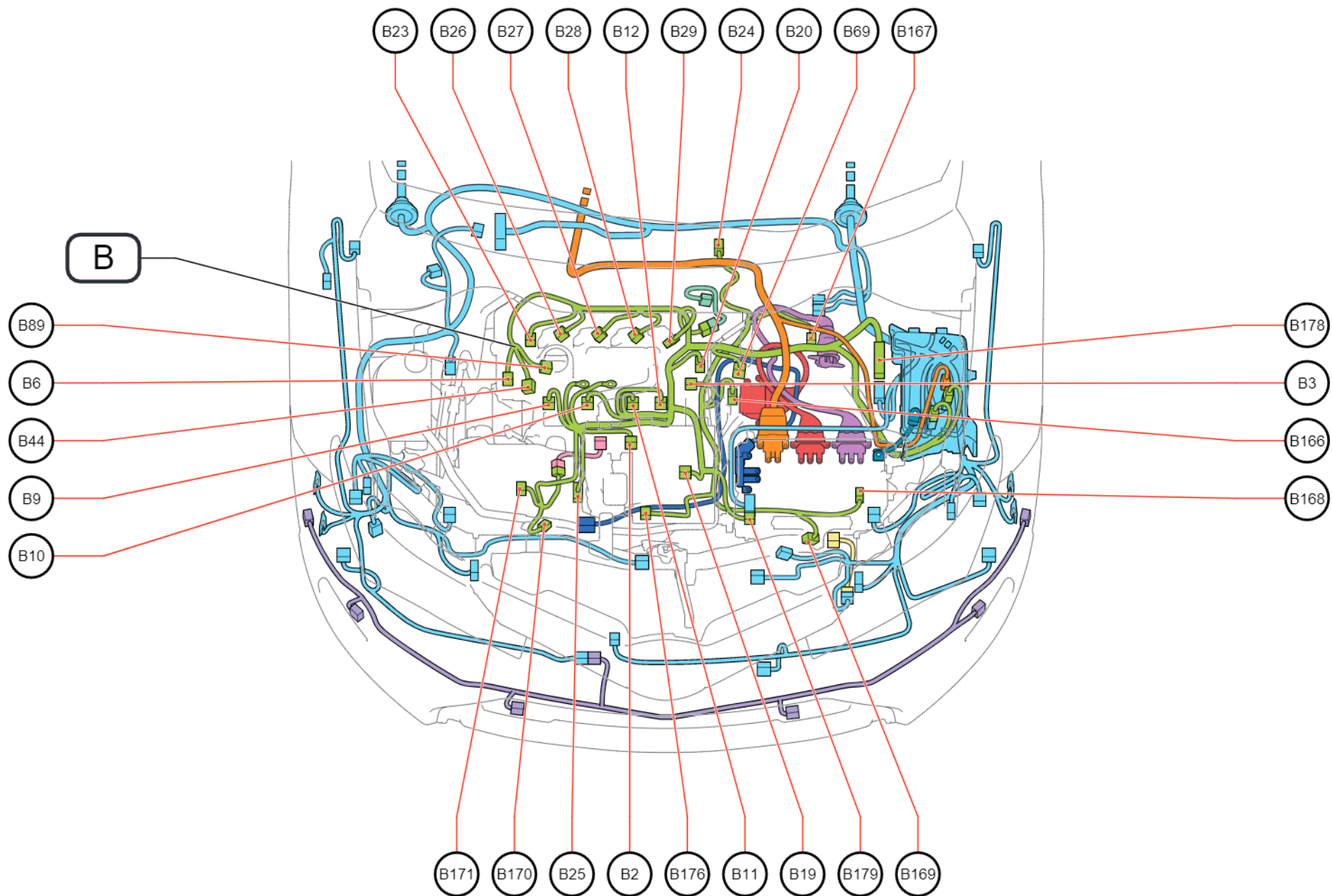

Position of Parts in Engine Compartment <RHD>

---

- B 2 Intake Mass Air Flow Meter Sub-Assembly
- B 3 E.F.I. Engine Coolant Temperature Sensor
- B 6 Engine Oil Pressure Switch Assembly
- B 9 Fuel Injector Assembly No. 1
- B 10 Fuel Injector Assembly No. 2
- B 11 Fuel Injector Assembly No. 3
- B 12 Fuel Injector Assembly No. 4
- B 19 Purge VSV (Vacuum Switching Valve Assembly)
- B 20 VVT Sensor (Intake Side)
- B 23 Camshaft Timing Oil Control Valve Assembly (Intake Side)
- B 24 Oxygen Sensor (Bank 1 Sensor 2)
- B 25 Throttle Body Assembly
- B 26 Ignition Coil Assembly No. 1
- B 27 Ignition Coil Assembly No. 2
- B 28 Ignition Coil Assembly No. 3
- B 29 Ignition Coil Assembly No. 4
- B 44 Crank Position Sensor
- B 69 EGR Valve Assembly
- B 89 Air Fuel Ratio Sensor (Bank 1 Sensor 1)
- B 166 Hybrid Vehicle Generator Assembly
- B 167 Hybrid Vehicle Generator Assembly
- B 168 Hybrid Vehicle Generator Assembly
- B 169 Shift Control Actuator Assembly
- B 170 Compressor with Motor Assembly
- B 171 Engine Water Pump Assembly
- B 176 E.F.I. Vacuum Sensor Assembly
- B 178 ECM
- B 179 Inverter with Converter Assembly

Position of Parts in Engine Compartment <RHD>

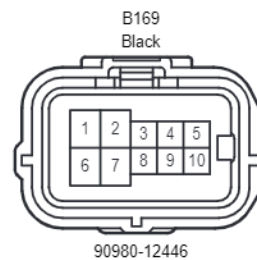
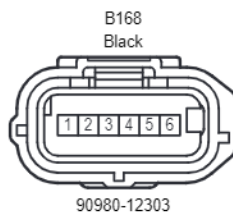
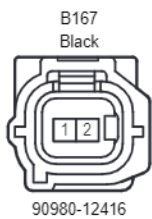
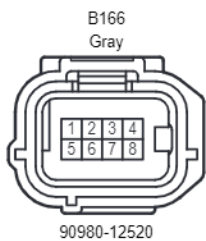
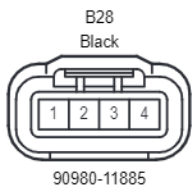
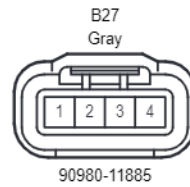
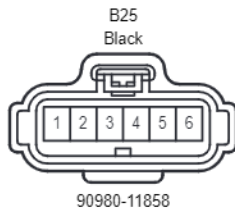
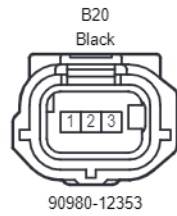
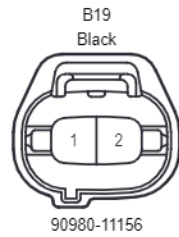
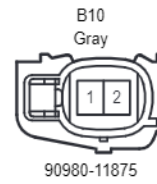
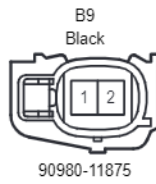
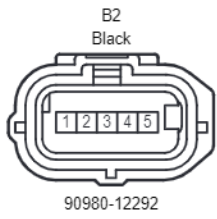

Position of Parts in Engine Compartment <RHD>

B178  
Black

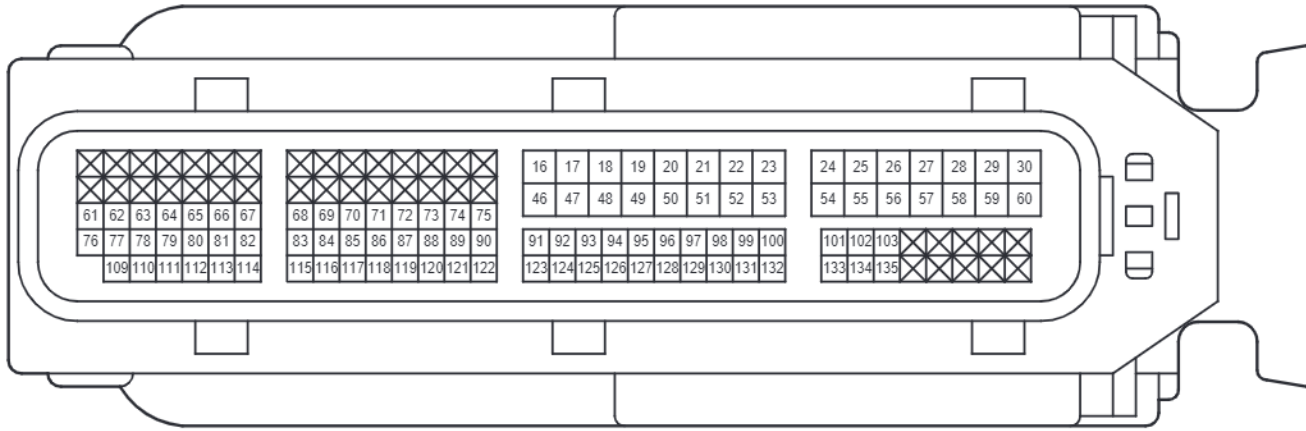

90980-12974

B179  
Black

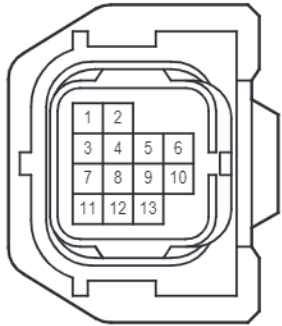

G9266-47010

Position of Parts in Engine Compartment <RHD>

\*3 : Prior Jun. 2013  
\*4 : From Jun. 2013 or later

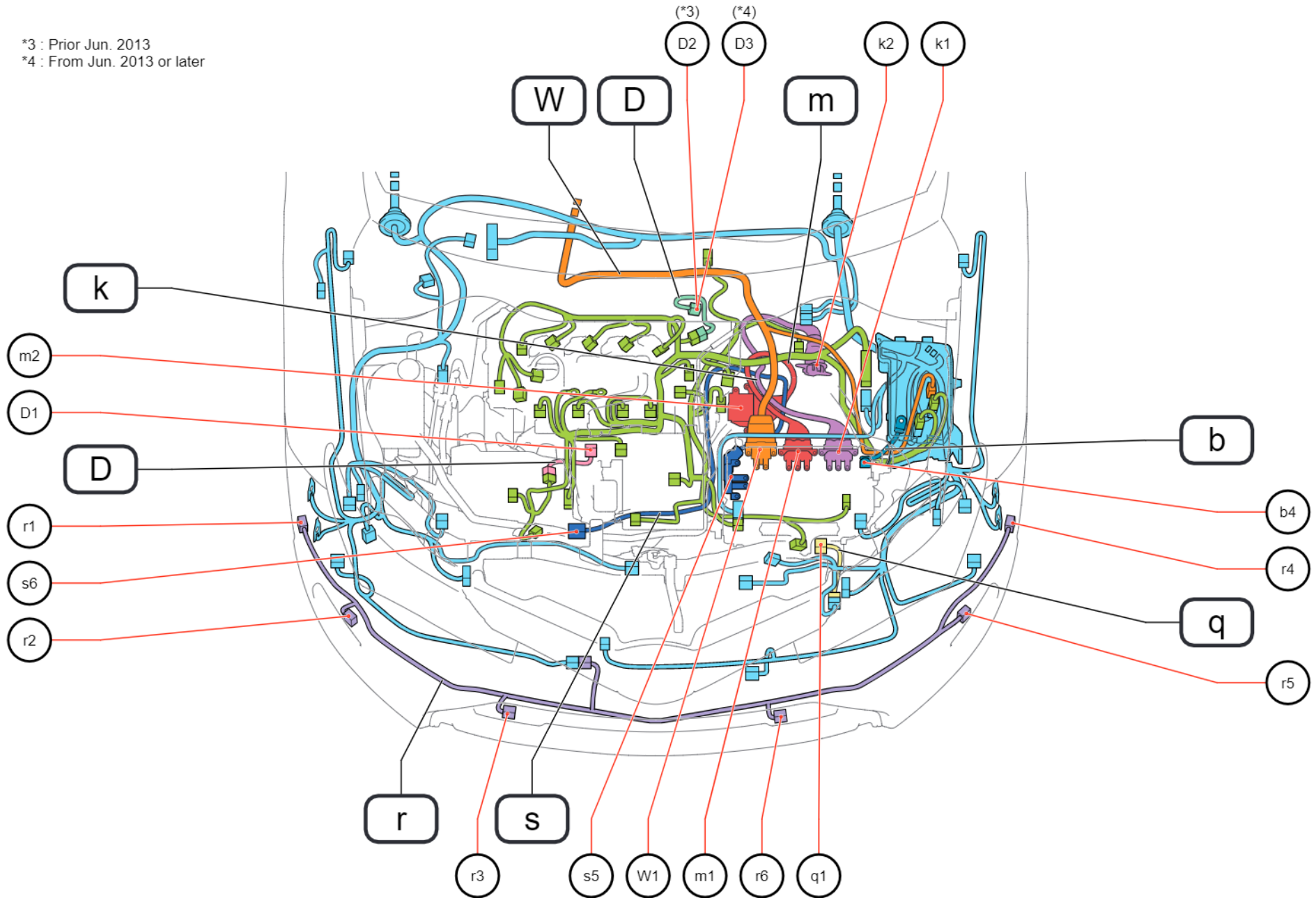



Position of Parts in Engine Compartment <RHD>

---

- D 1 Knock Control Sensor (Bank 1)
- D 2 Engine Coolant Temperature Sensor
- D 3 Engine Coolant Temperature Sensor
  
- W 1 Inverter with Converter Assembly
  
- b 4 Inverter with Converter Assembly
  
- k 1 Inverter with Converter Assembly
- k 2 Hybrid Vehicle Generator Assembly
  
- m 1 Inverter with Converter Assembly
- m 2 Hybrid Vehicle Generator Assembly
  
- q 1 Water Pump with Motor Assembly
  
- r 1 Front No. 1 Ultrasonic Sensor RH Side
- r 2 Front No. 1 Ultrasonic Sensor RH
- r 3 Front No. 1 Ultrasonic Sensor RH Center
- r 4 Front No. 1 Ultrasonic Sensor LH Side
- r 5 Front No. 1 Ultrasonic Sensor LH
- r 6 Front No. 1 Ultrasonic Sensor LH Center
  
- s 5 Compressor with Motor Assembly
- s 6 Inverter with Converter Assembly

Position of Parts in Engine Compartment <RHD>

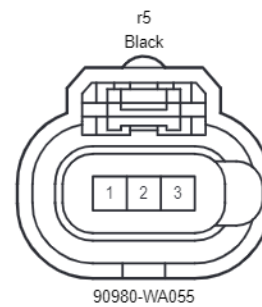
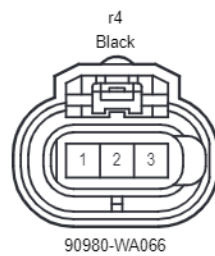
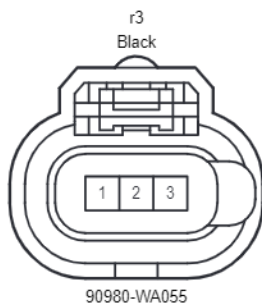
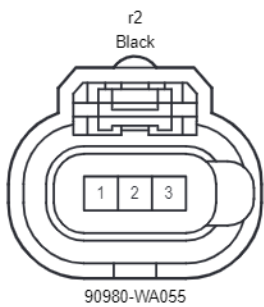
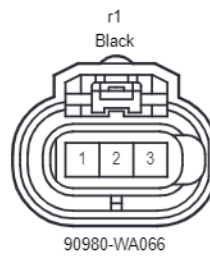
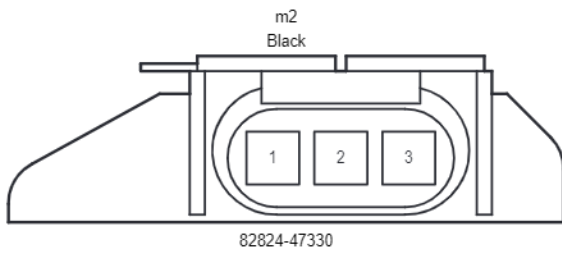
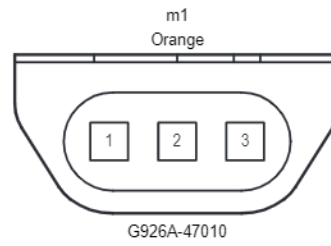
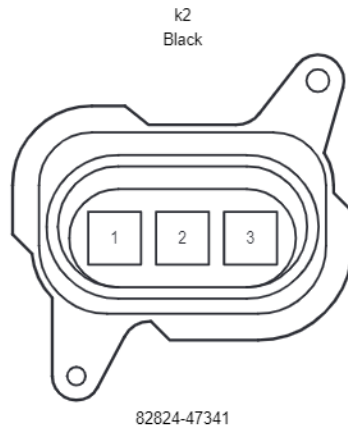
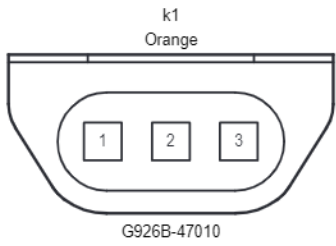
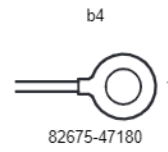
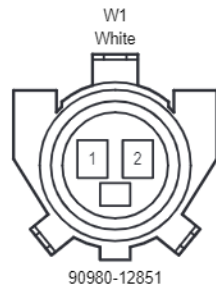
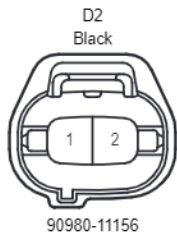

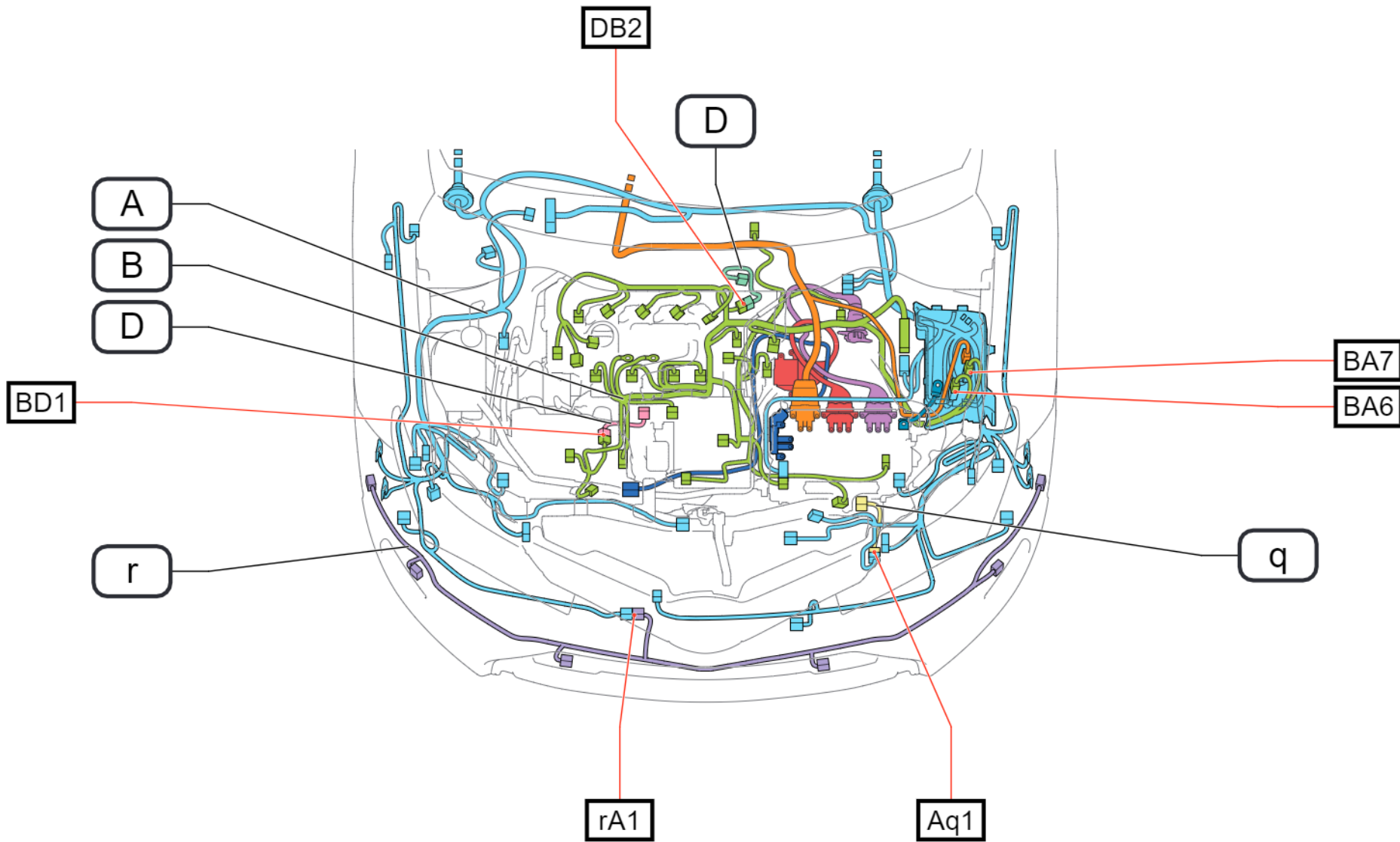

Wire and Wire in Engine Compartment <RHD>

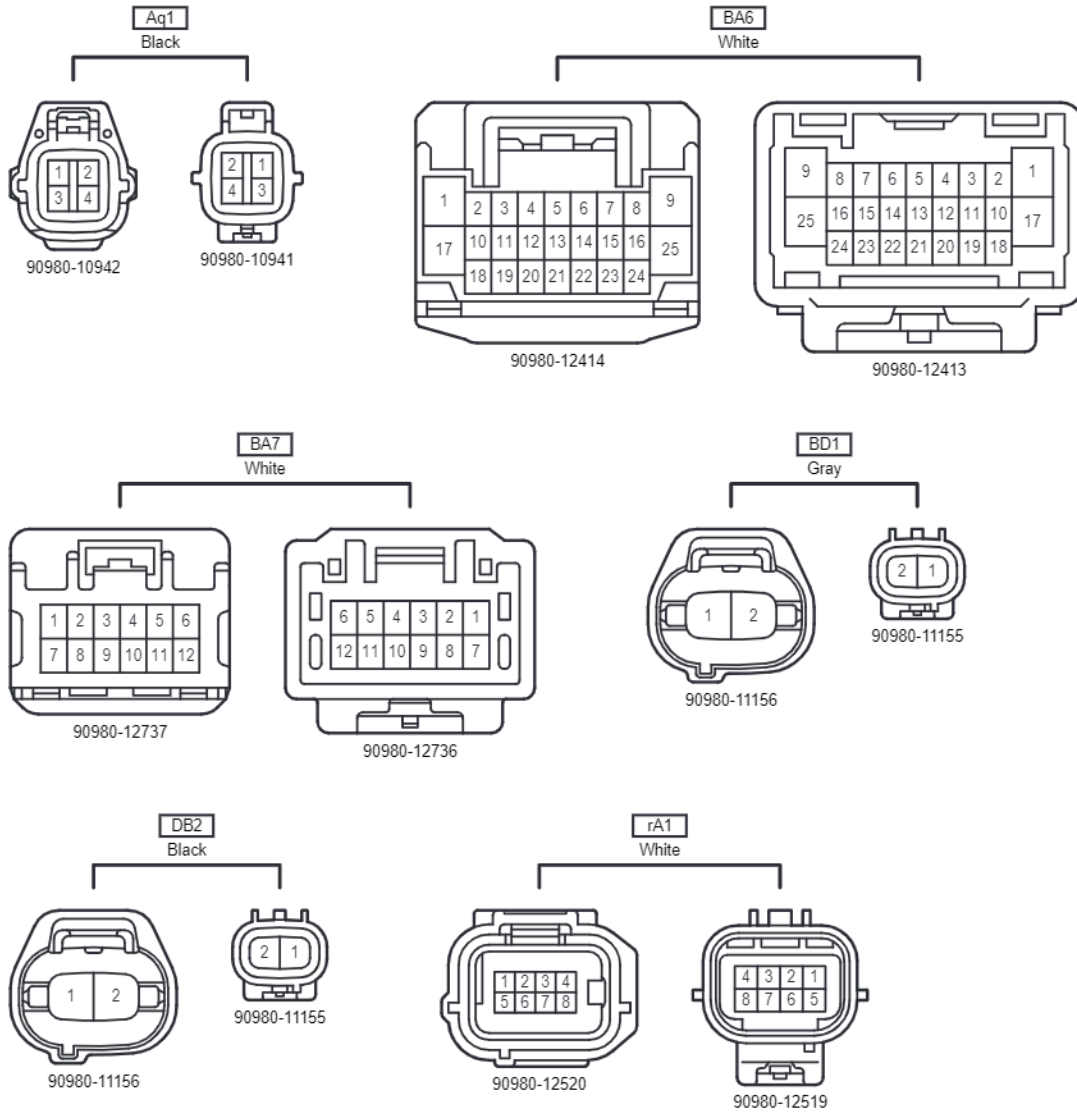

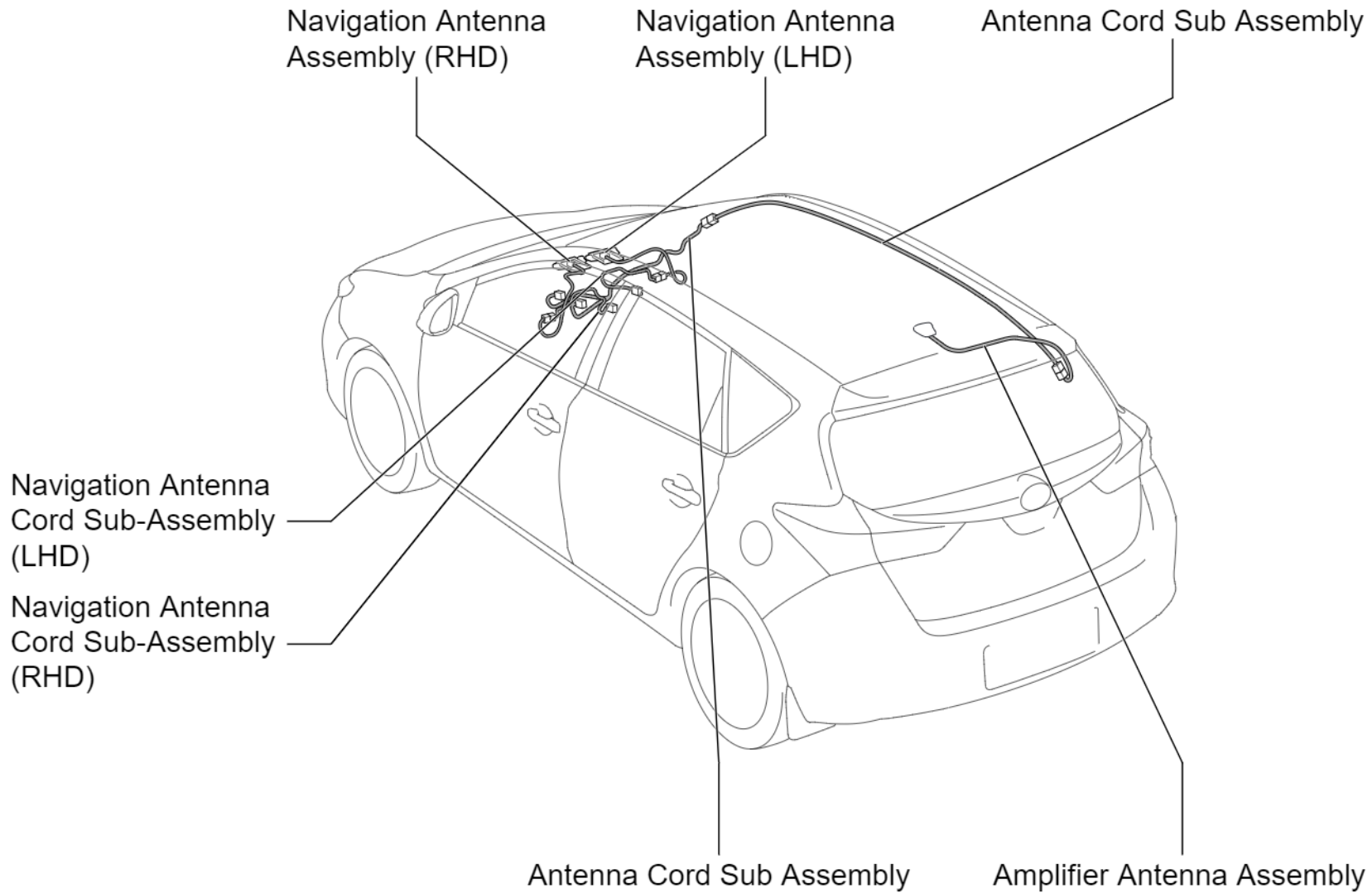

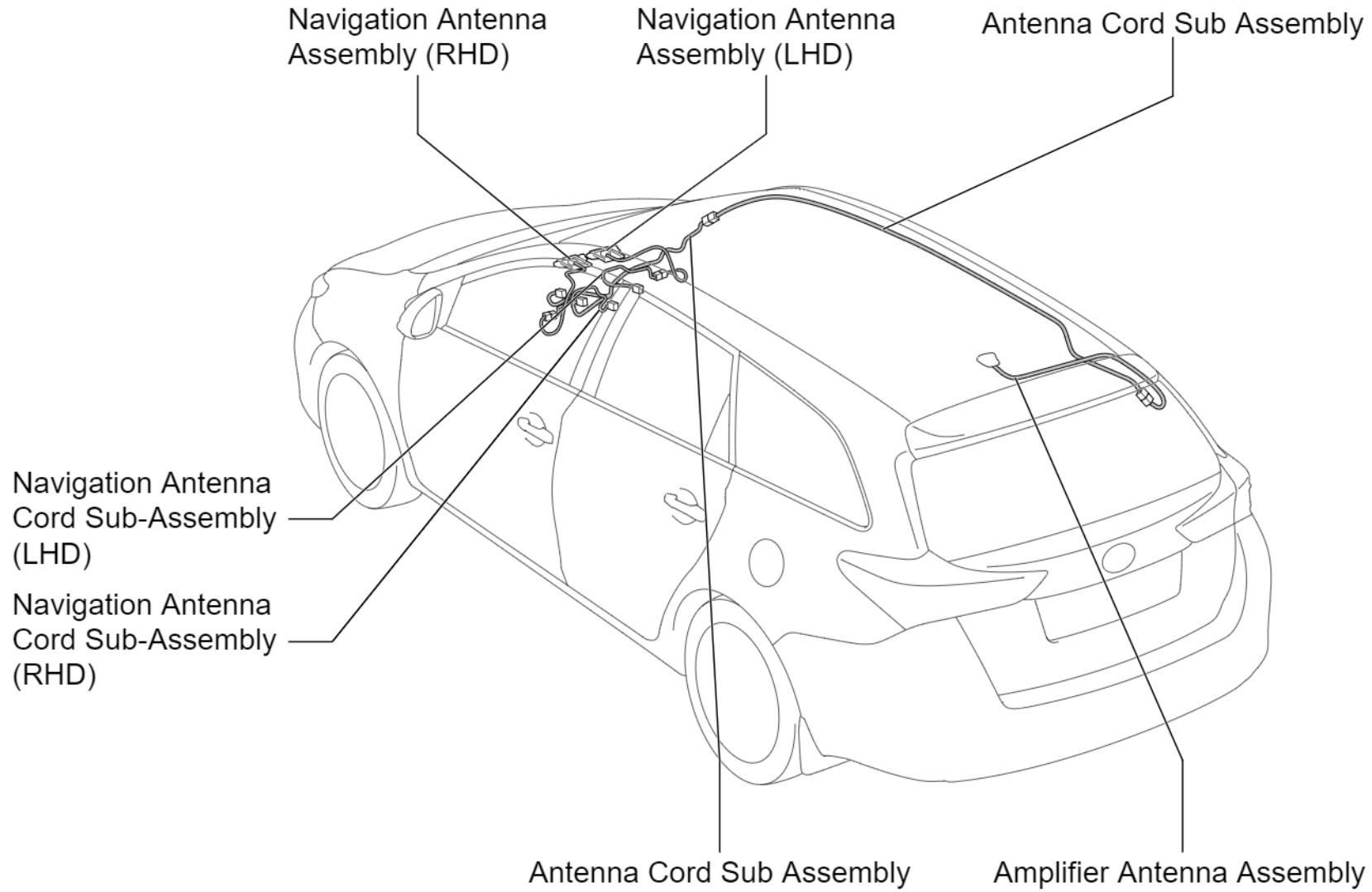

Ground Points in Engine Compartment <LHD>

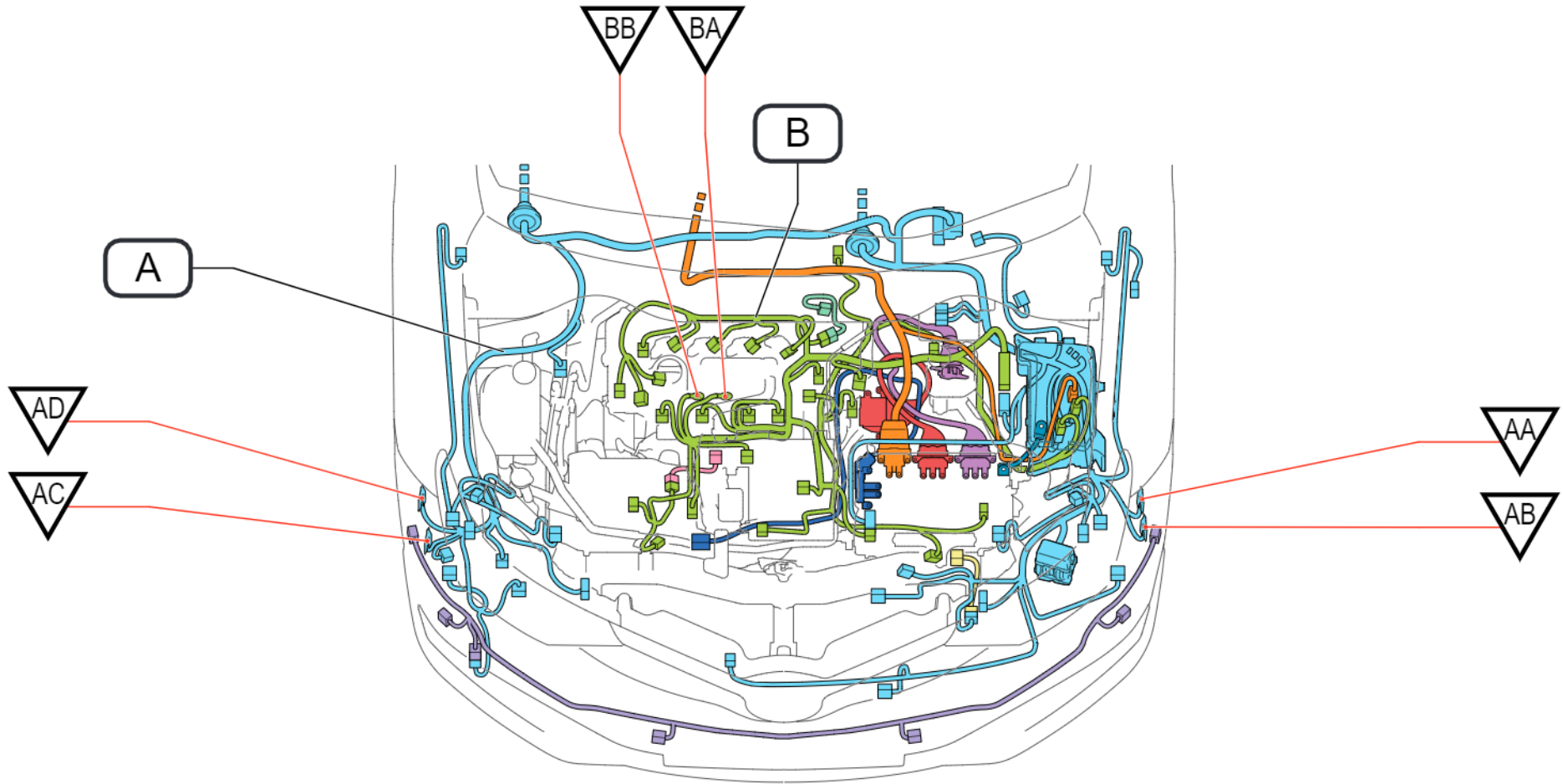

Position of Parts in Engine Compartment <LHD>

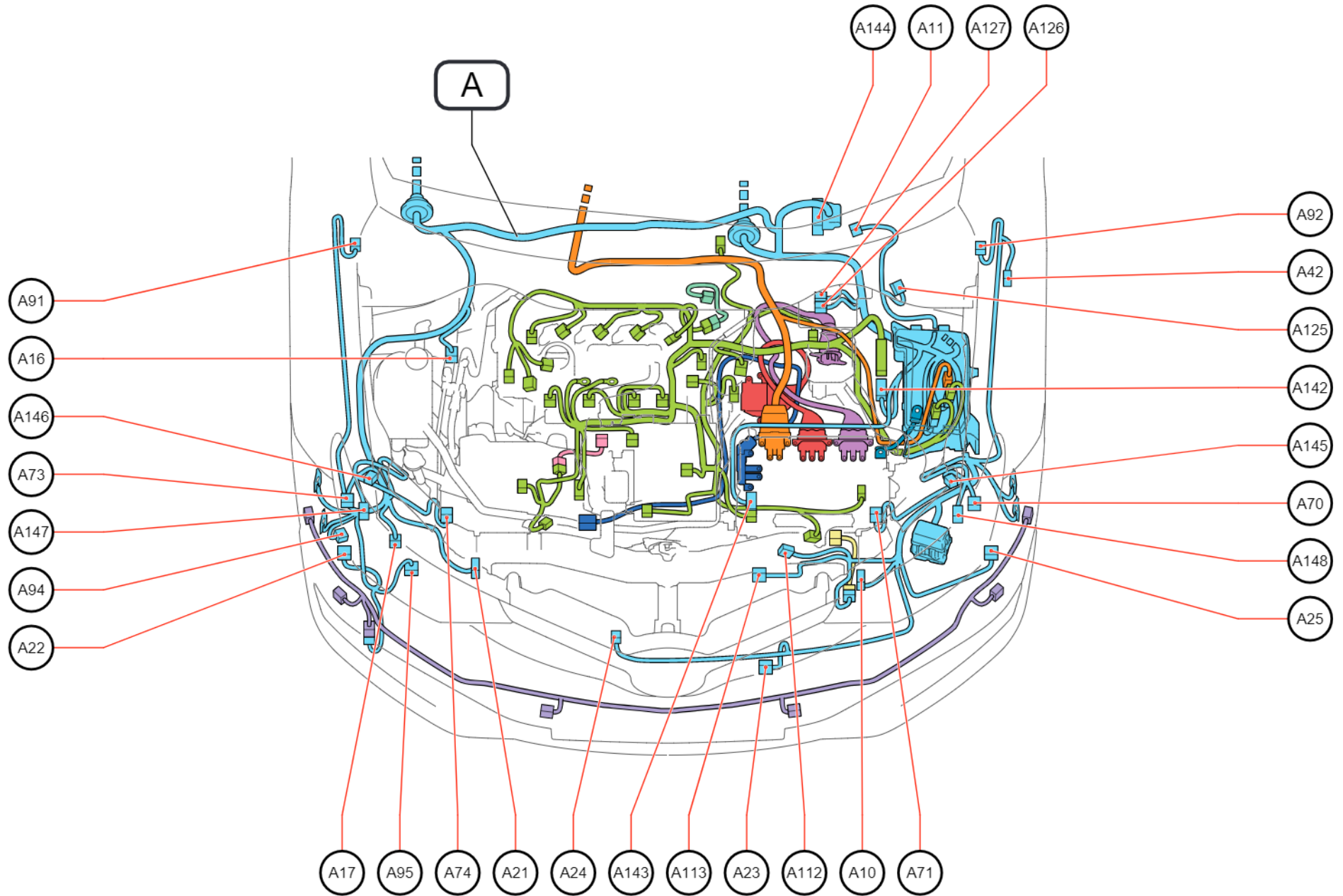



Position of Parts in Engine Compartment <LHD>

---

- A 10 Front Airbag Sensor LH
- A 11 Windshield Wiper Motor Assembly
- A 16 A/C Pressure Sensor (Air Conditioner Tube & Accessory Assembly)
- A 17 Windshield Washer Motor and Pump Assembly
- A 21 Front Airbag Sensor RH
- A 22 Fog Light Assembly RH
- A 23 Ambient Temperature Sensor (Thermistor Assembly)
- A 24 High Pitched Horn Assembly
- A 25 Fog Light Assembly LH
- A 42 Wireless Door Lock Buzzer
- A 70 Headlight Assembly LH
- A 71 Headlight Assembly LH
- A 73 Headlight Assembly RH
- A 74 Headlight Assembly RH
- A 91 Front Speed Sensor RH
- A 92 Front Speed Sensor LH
- A 94 Headlight Cleaner Control Relay
- A 95 Headlight Cleaner Washer Motor and Pump Assembly
- A 112 Cooling Fan Motor
- A 113 No. 2 Cooling Fan Motor
- A 125 Brake Fluid Level Warning Switch (Brake Master Cylinder Reservoir Assembly)
- A 126 Brake Booster Pump Assembly
- A 127 Brake Booster Pump Assembly
- A 142 ECM
- A 143 Inverter with Converter Assembly
- A 144 Brake Actuator Assembly (Brake Booster with Master Cylinder Assembly)
- A 145 Headlight Assembly LH
- A 146 Headlight Assembly RH
- A 147 Headlight Assembly RH
- A 148 Headlight Assembly LH

Position of Parts in Engine Compartment <LHD>

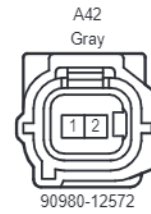
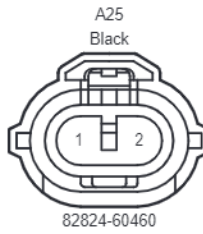
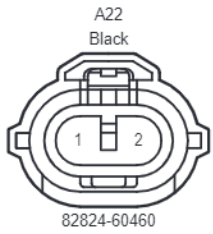
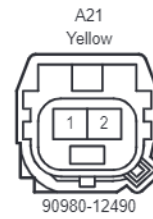
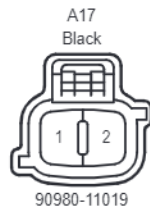
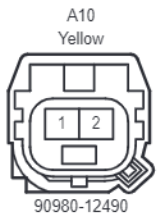

(Headlight Halogen Type, Clearance Light, DRL and Solenoid)

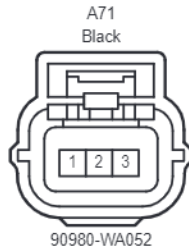

(Headlight Leveling Motor)



(Headlight Halogen Type, Clearance Light, DRL and Solenoid)

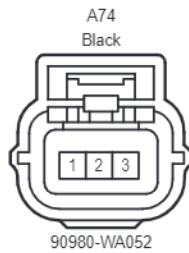

(Headlight Leveling Motor)

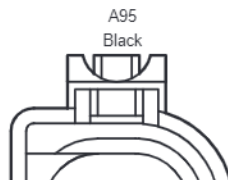
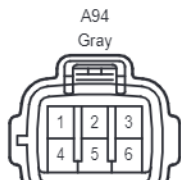
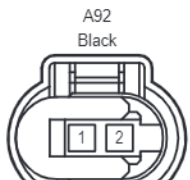
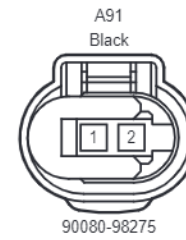

Position of Parts in Engine Compartment <LHD>

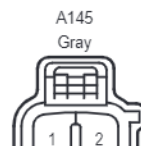
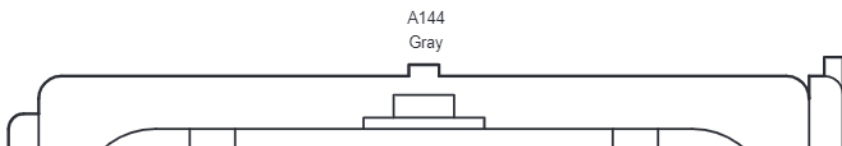
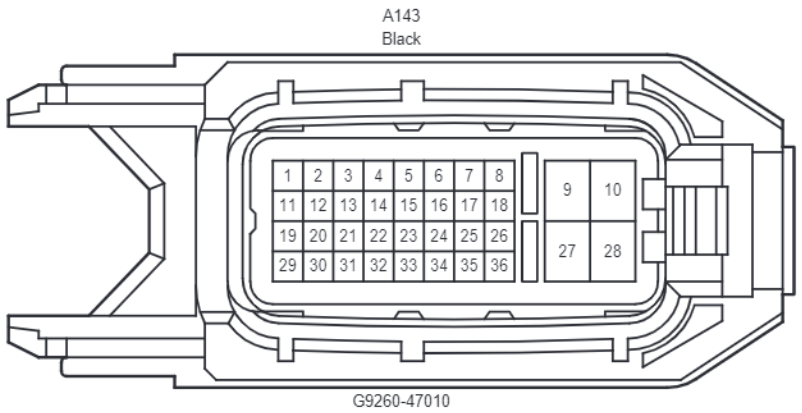
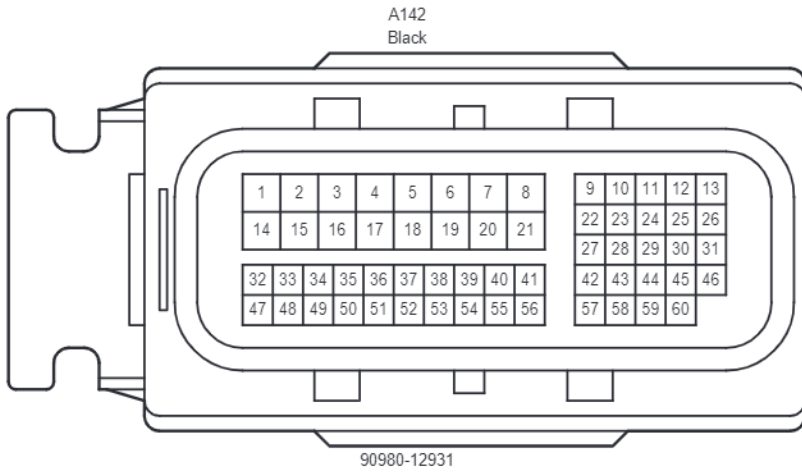

Position of Parts in Engine Compartment <LHD>

---

A146  
Gray

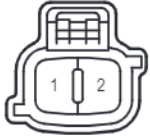

90980-11019

(Front Turn Signal Light)

A147  
White



90980-10942

(Headlight LED Type)

A148  
White



90980-10942

(Headlight LED Type)

Position of Parts in Engine Compartment <LHD>

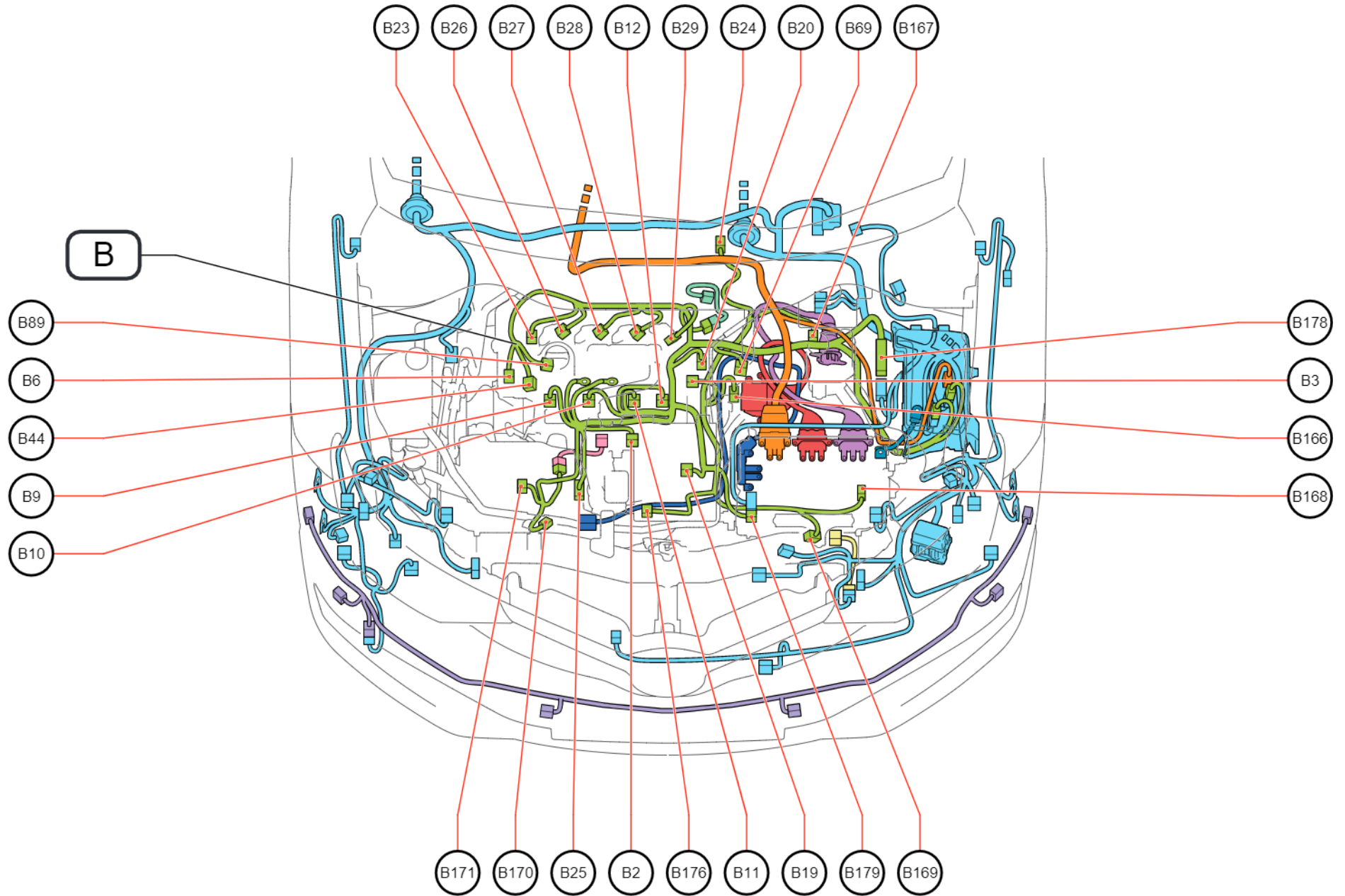

Position of Parts in Engine Compartment <LHD>

---

- B 2 Intake Mass Air Flow Meter Sub-Assembly
- B 3 E.F.I. Engine Coolant Temperature Sensor
- B 6 Engine Oil Pressure Switch Assembly
- B 9 Fuel Injector Assembly No. 1
- B 10 Fuel Injector Assembly No. 2
- B 11 Fuel Injector Assembly No. 3
- B 12 Fuel Injector Assembly No. 4
- B 19 Purge VSV (Vacuum Switching Valve Assembly)
- B 20 VVT Sensor (Intake Side)
- B 23 Camshaft Timing Oil Control Valve Assembly (Intake Side)
- B 24 Oxygen Sensor (Bank 1 Sensor 2)
- B 25 Throttle Body Assembly
- B 26 Ignition Coil Assembly No. 1
- B 27 Ignition Coil Assembly No. 2
- B 28 Ignition Coil Assembly No. 3
- B 29 Ignition Coil Assembly No. 4
- B 44 Crank Position Sensor
- B 69 EGR Valve Assembly
- B 89 Air Fuel Ratio Sensor (Bank 1 Sensor 1)
- B 166 Hybrid Vehicle Generator Assembly
- B 167 Hybrid Vehicle Generator Assembly
- B 168 Hybrid Vehicle Generator Assembly
- B 169 Shift Control Actuator Assembly
- B 170 Compressor with Motor Assembly
- B 171 Engine Water Pump Assembly
- B 176 E.F.I. Vacuum Sensor Assembly
- B 178 ECM
- B 179 Inverter with Converter Assembly

Position of Parts in Engine Compartment <LHD>

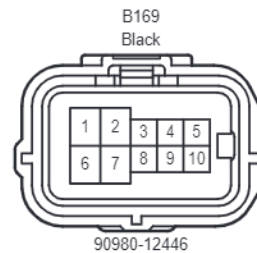
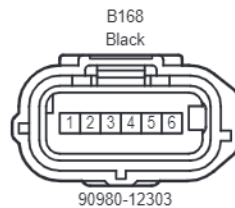
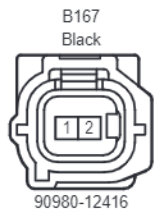
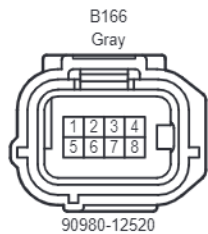
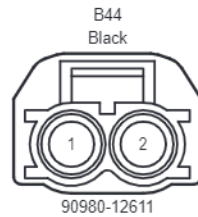
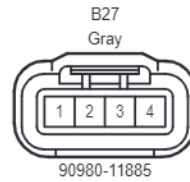
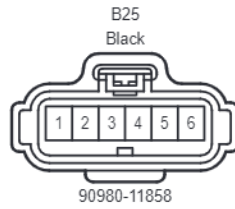
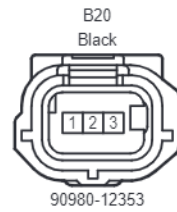
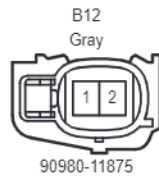
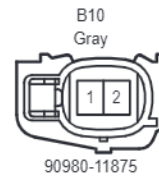
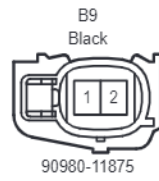
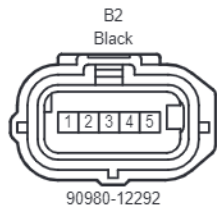

Position of Parts in Engine Compartment <LHD>

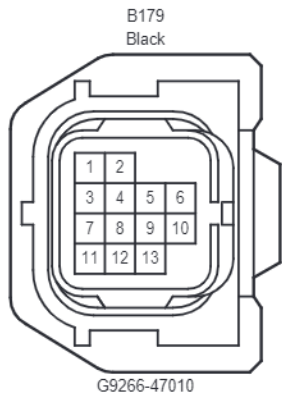
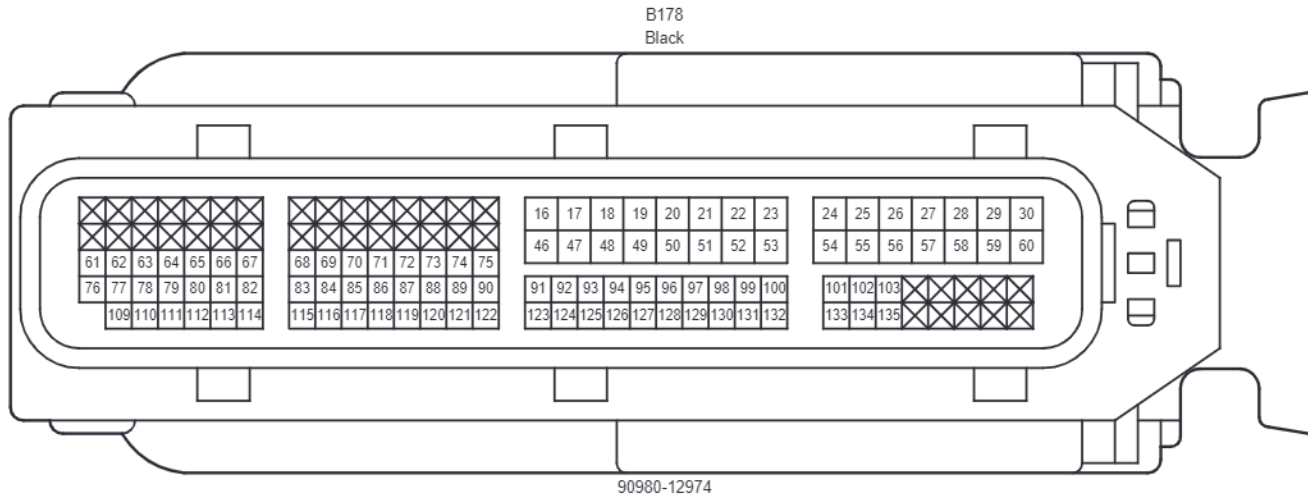



Position of Parts in Engine Compartment <LHD>

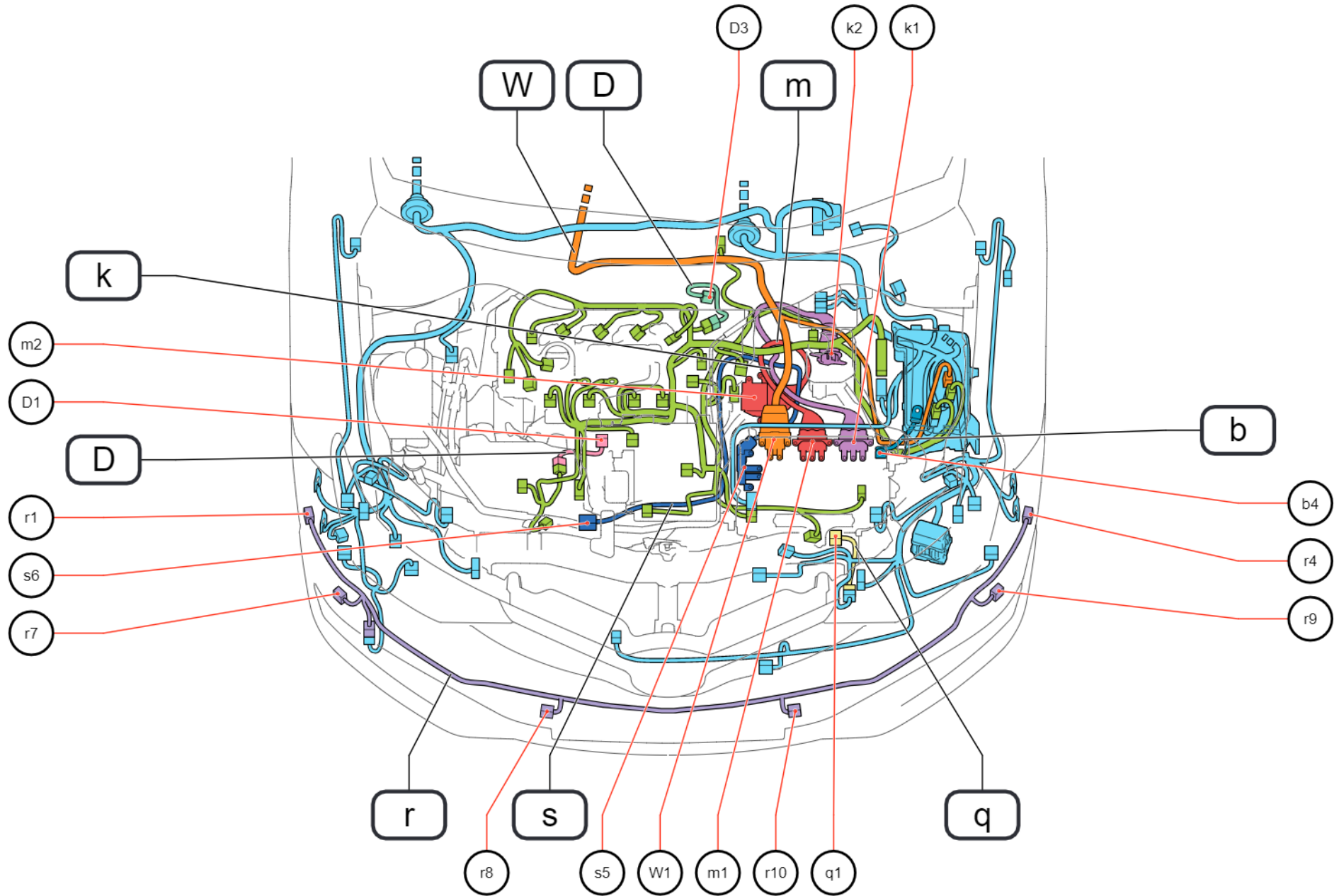

Position of Parts in Engine Compartment <LHD>

---

- D 1 Knock Control Sensor (Bank 1)
- D 3 Engine Coolant Temperature Sensor

W 1 Inverter with Converter Assembly

b 4 Inverter with Converter Assembly

- k 1 Inverter with Converter Assembly
- k 2 Hybrid Vehicle Generator Assembly

- m 1 Inverter with Converter Assembly
- m 2 Hybrid Vehicle Generator Assembly

q 1 Water Pump with Motor Assembly

- r 1 Front No. 1 Ultrasonic Sensor RH Side
- r 4 Front No. 1 Ultrasonic Sensor LH Side
- r 7 Front No. 1 Ultrasonic Sensor RH
- r 8 Front No. 1 Ultrasonic Sensor RH Center
- r 9 Front No. 1 Ultrasonic Sensor LH
- r 10 Front No. 1 Ultrasonic Sensor LH Center

- s 5 Compressor with Motor Assembly
- s 6 Inverter with Converter Assembly

Position of Parts in Engine Compartment <LHD>

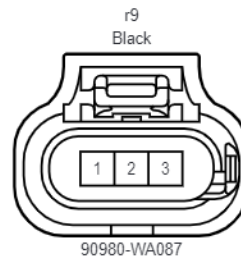
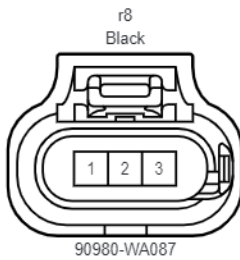
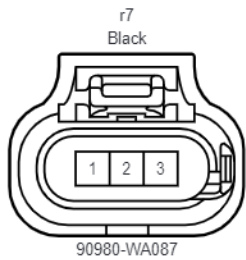
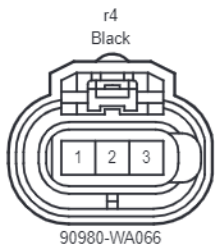
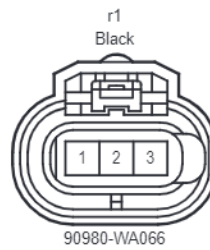
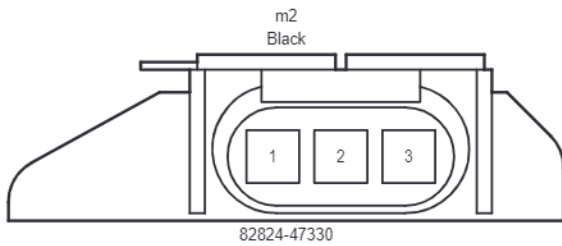
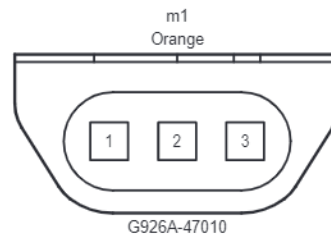
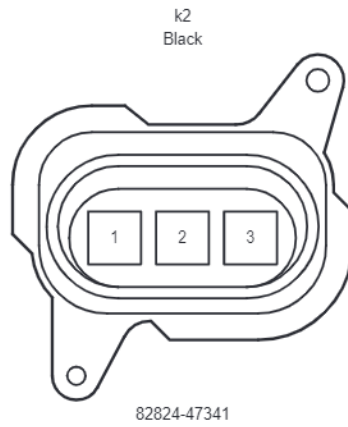
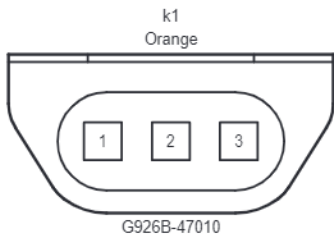
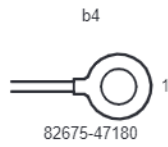

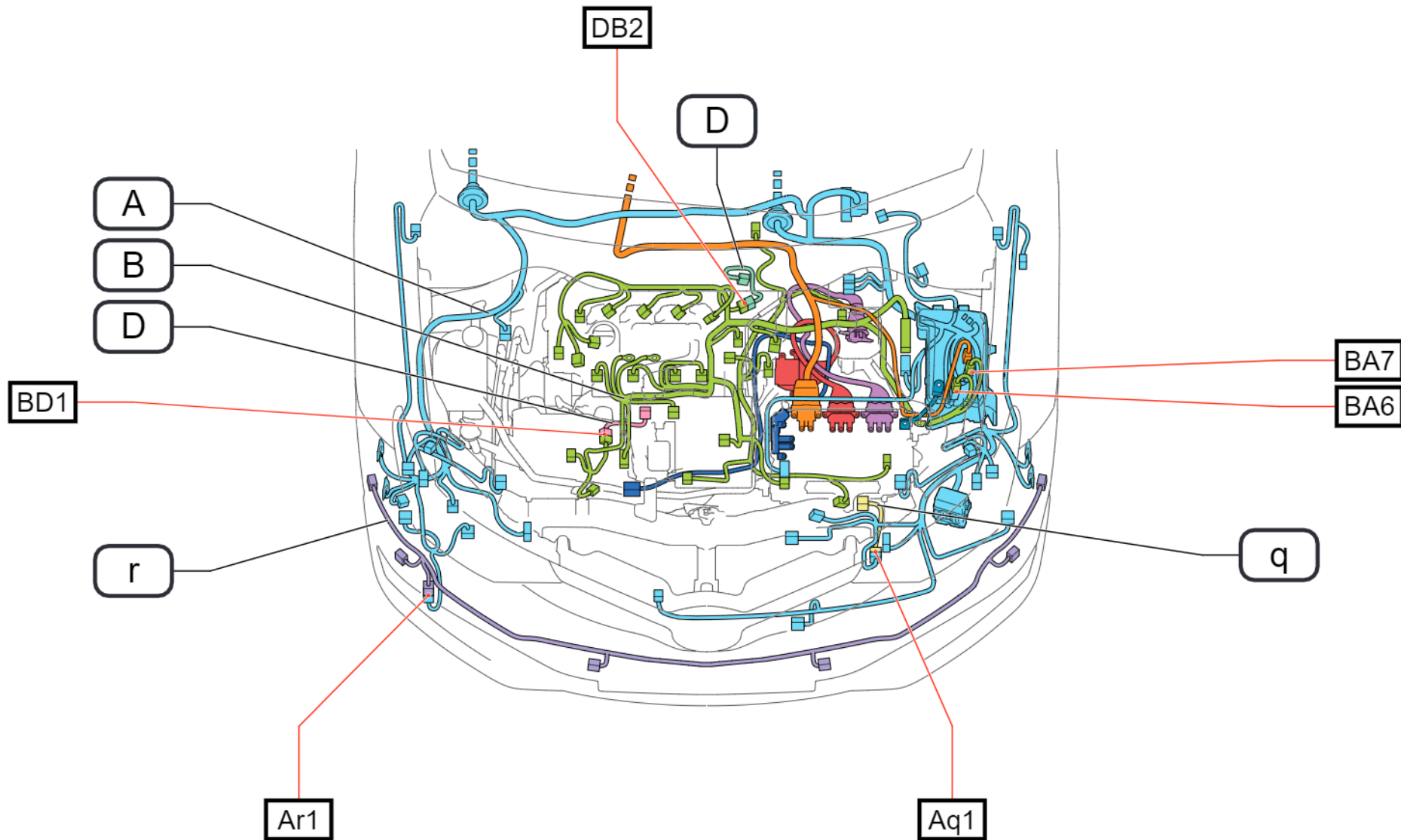

Wire and Wire in Engine Compartment <LHD>

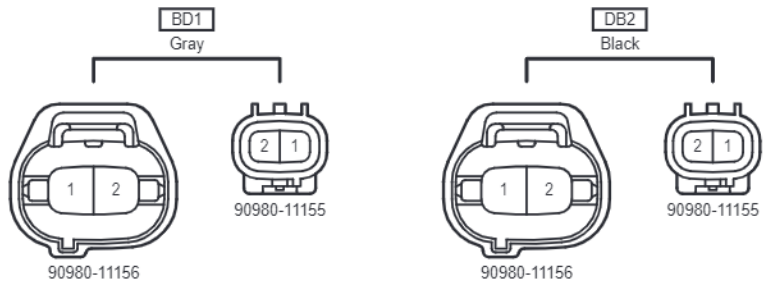
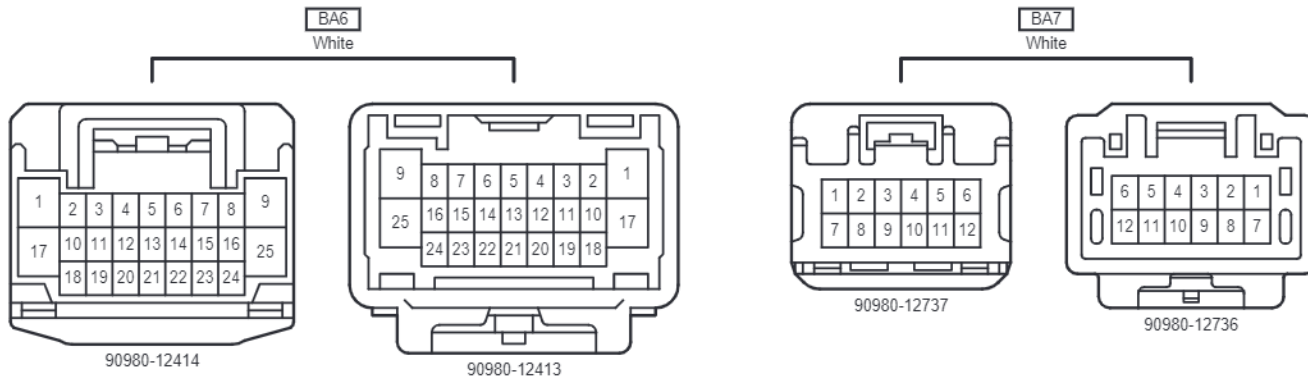
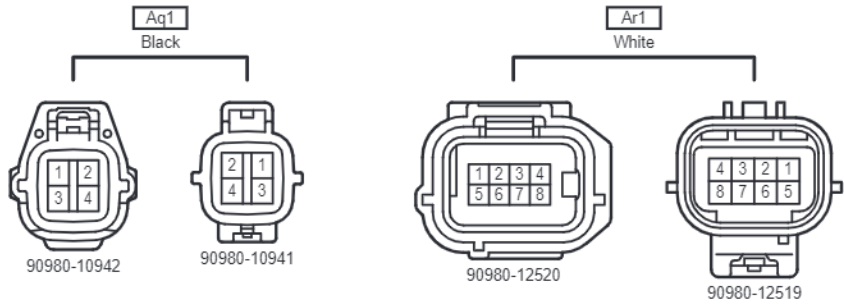

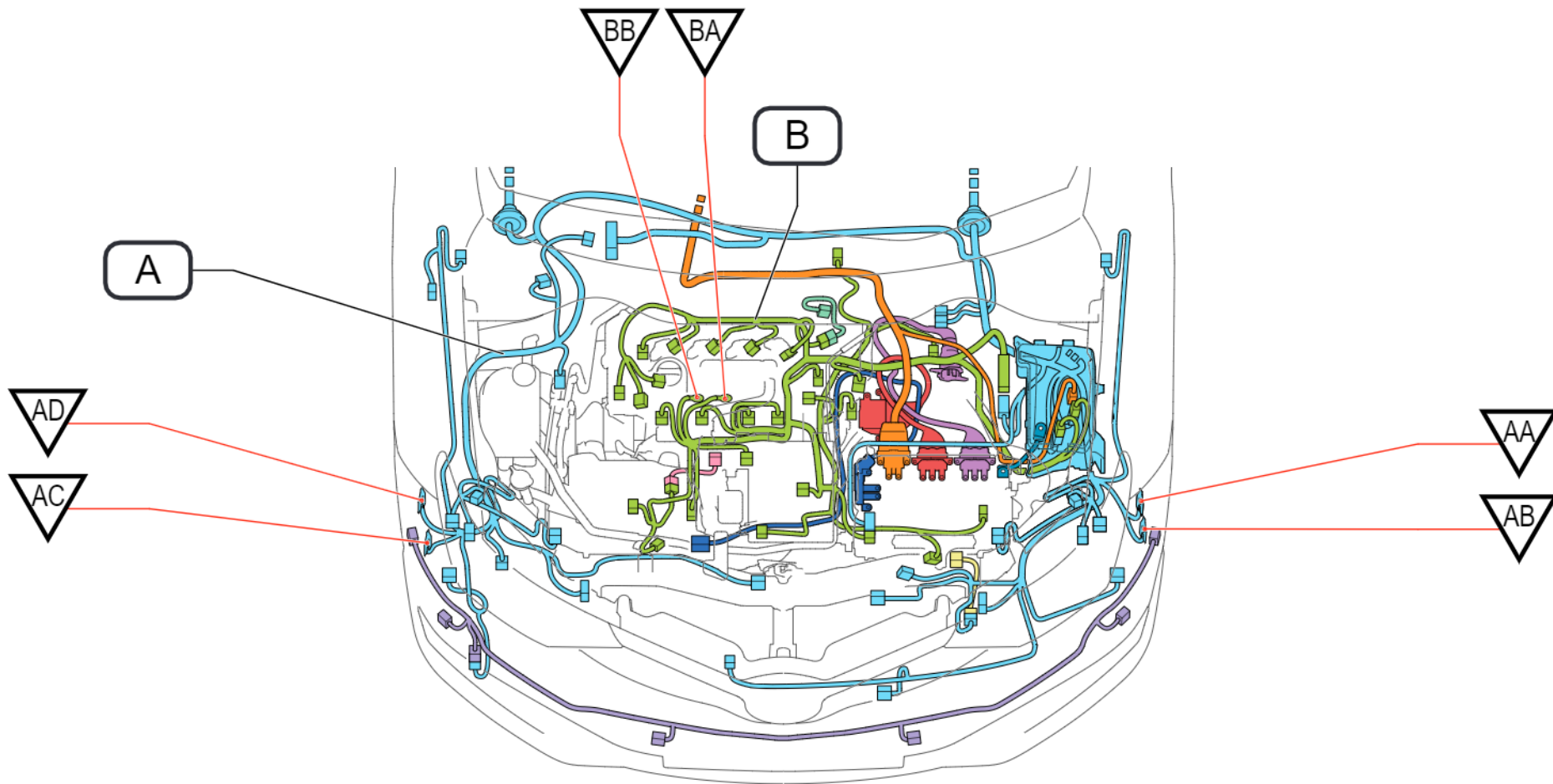

Position of Parts in Engine Compartment <RHD>

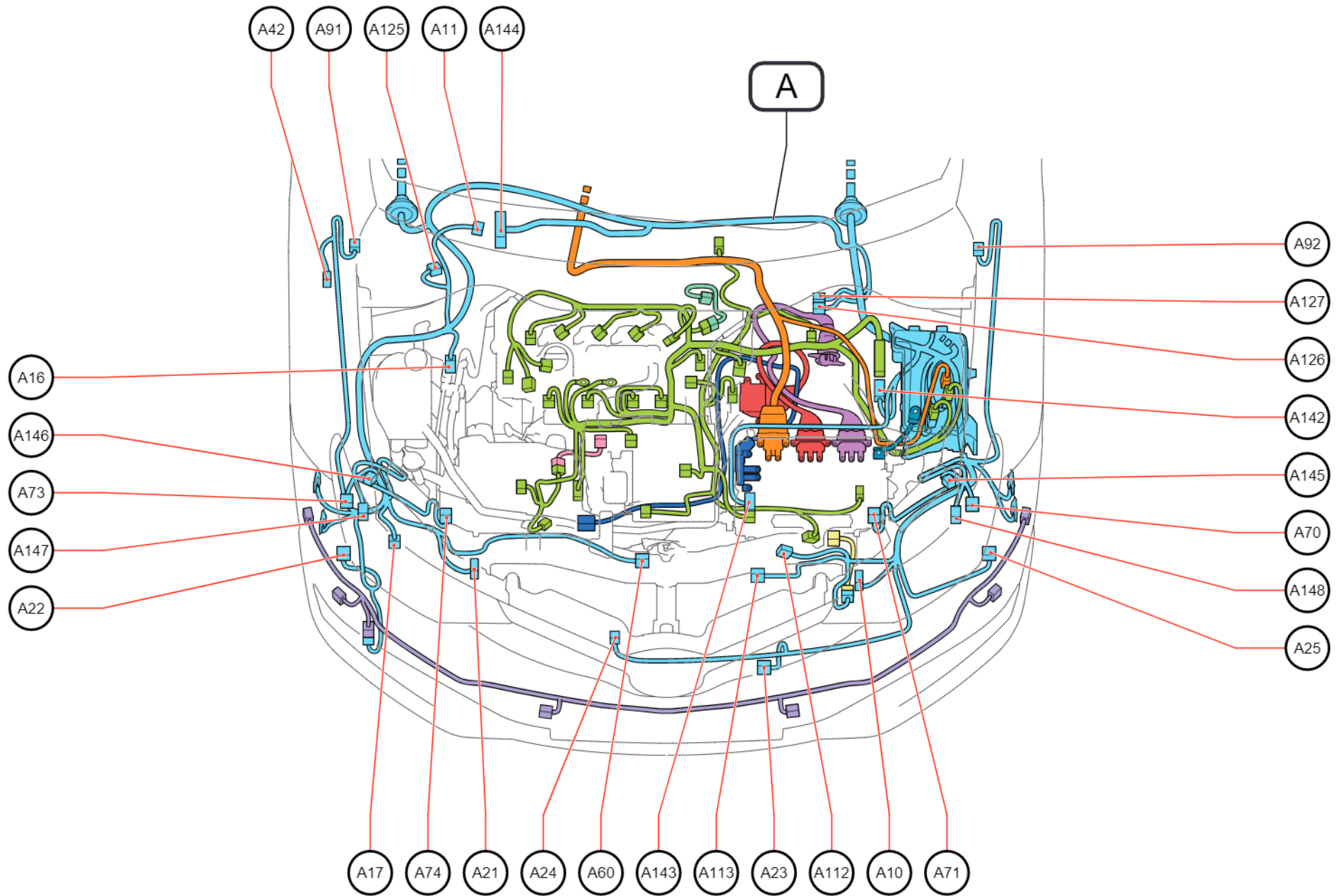

Position of Parts in Engine Compartment <RHD>

---

- A 10 Front Airbag Sensor LH
- A 11 Windshield Wiper Motor Assembly
- A 16 A/C Pressure Sensor (Air Conditioner Tube & Accessory Assembly)
- A 17 Windshield Washer Motor and Pump Assembly
- A 21 Front Airbag Sensor RH
- A 22 Fog Light Assembly RH
- A 23 Ambient Temperature Sensor (Thermistor Assembly)
- A 24 High Pitched Horn Assembly
- A 25 Fog Light Assembly LH
- A 42 Wireless Door Lock Buzzer
- A 60 Hood Courtesy Switch (Hood Lock Assembly)
- A 70 Headlight Assembly LH
- A 71 Headlight Assembly LH
- A 73 Headlight Assembly RH
- A 74 Headlight Assembly RH
- A 91 Front Speed Sensor RH
- A 92 Front Speed Sensor LH
- A 112 Cooling Fan Motor
- A 113 No. 2 Cooling Fan Motor
- A 125 Brake Fluid Level Warning Switch (Brake Master Cylinder Reservoir Assembly)
- A 126 Brake Booster Pump Assembly
- A 127 Brake Booster Pump Assembly
- A 142 ECM
- A 143 Inverter with Converter Assembly
- A 144 Brake Actuator Assembly (Brake Booster with Master Cylinder Assembly)
- A 145 Headlight Assembly LH
- A 146 Headlight Assembly RH
- A 147 Headlight Assembly RH
- A 148 Headlight Assembly LH



Position of Parts in Engine Compartment <RHD>

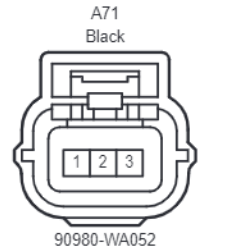
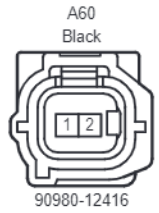
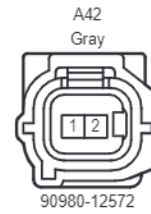
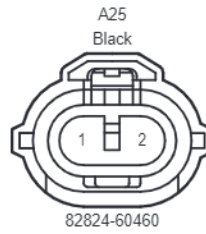
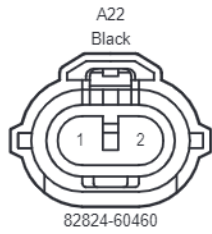
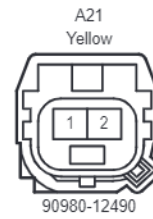
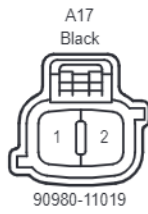
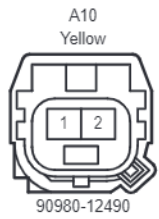

(Headlight Halogen Type, Clearance Light, DRL and Solenoid)

(Headlight Leveling Motor)

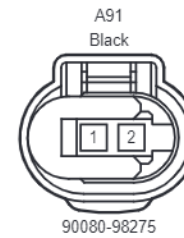
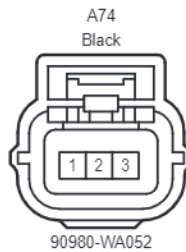

(Headlight Halogen Type, Clearance Light, DRL and Solenoid)

(Headlight Leveling Motor)

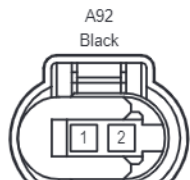

Position of Parts in Engine Compartment <RHD>

A142  
Black

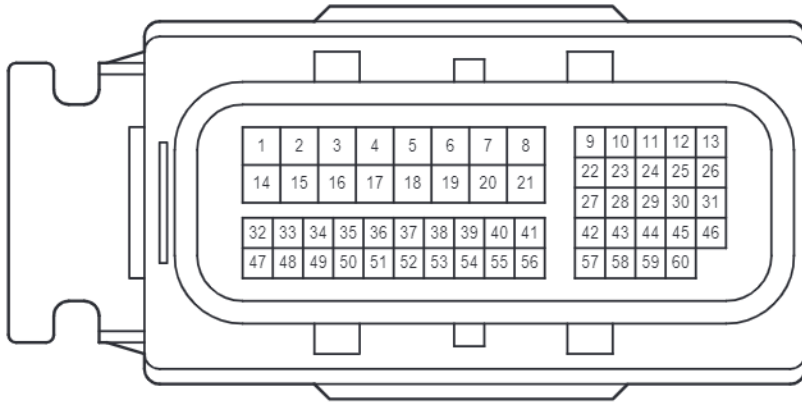

90980-12931

A143  
Black

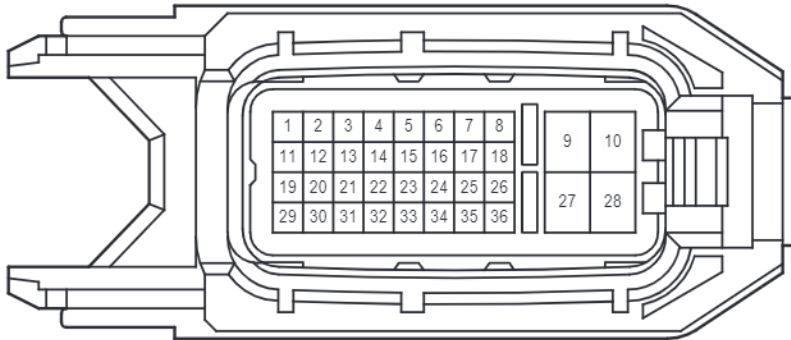

G9260-47010

A144  
Gray

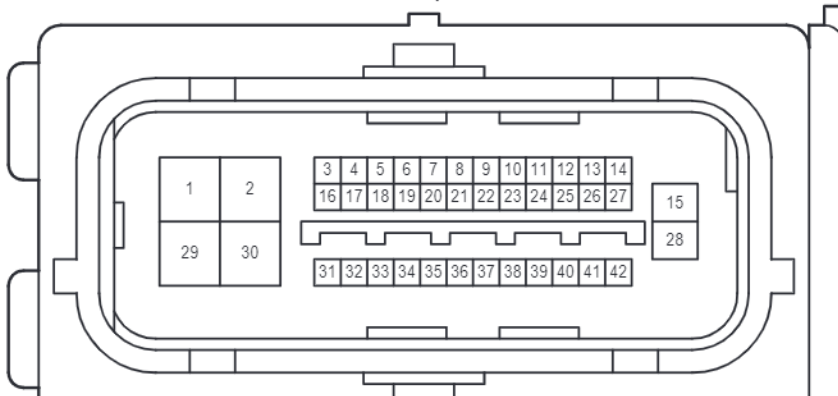

A145  
Gray



90980-11019

(Front Turn Signal Light)

Position of Parts in Engine Compartment <RHD>

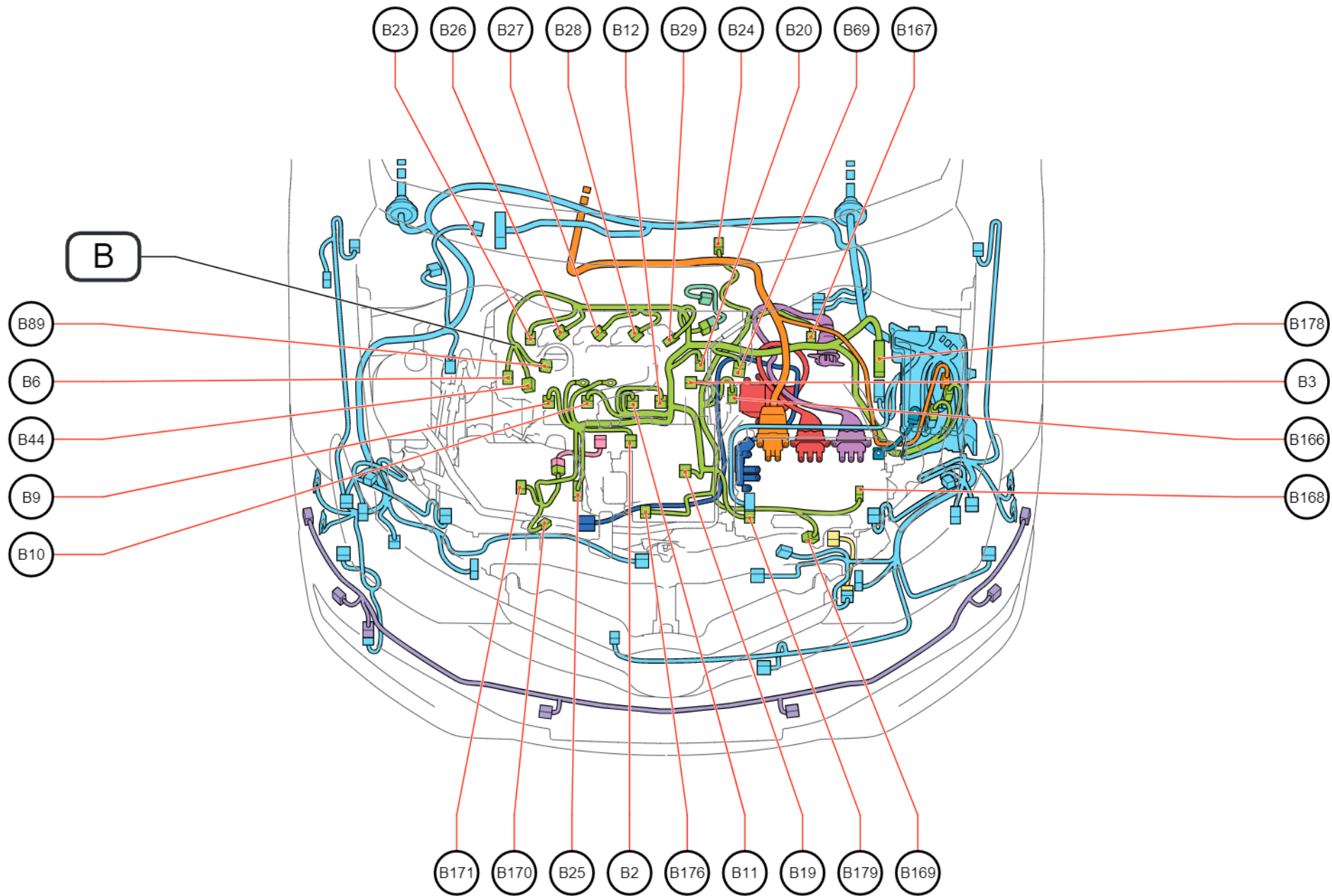

Position of Parts in Engine Compartment <RHD>

---

- B 2 Intake Mass Air Flow Meter Sub-Assembly
- B 3 E.F.I. Engine Coolant Temperature Sensor
- B 6 Engine Oil Pressure Switch Assembly
- B 9 Fuel Injector Assembly No. 1
- B 10 Fuel Injector Assembly No. 2
- B 11 Fuel Injector Assembly No. 3
- B 12 Fuel Injector Assembly No. 4
- B 19 Purge VSV (Vacuum Switching Valve Assembly)
- B 20 VVT Sensor (Intake Side)
- B 23 Camshaft Timing Oil Control Valve Assembly (Intake Side)
- B 24 Oxygen Sensor (Bank 1 Sensor 2)
- B 25 Throttle Body Assembly
- B 26 Ignition Coil Assembly No. 1
- B 27 Ignition Coil Assembly No. 2
- B 28 Ignition Coil Assembly No. 3
- B 29 Ignition Coil Assembly No. 4
- B 44 Crank Position Sensor
- B 69 EGR Valve Assembly
- B 89 Air Fuel Ratio Sensor (Bank 1 Sensor 1)
- B 166 Hybrid Vehicle Generator Assembly
- B 167 Hybrid Vehicle Generator Assembly
- B 168 Hybrid Vehicle Generator Assembly
- B 169 Shift Control Actuator Assembly
- B 170 Compressor with Motor Assembly
- B 171 Engine Water Pump Assembly
- B 176 E.F.I. Vacuum Sensor Assembly
- B 178 ECM
- B 179 Inverter with Converter Assembly

Position of Parts in Engine Compartment <RHD>

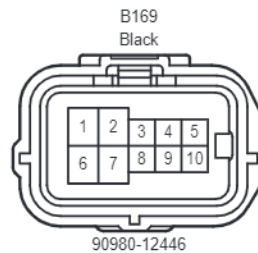
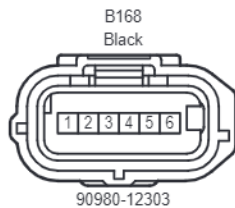
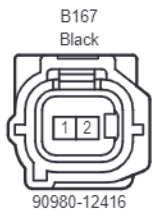
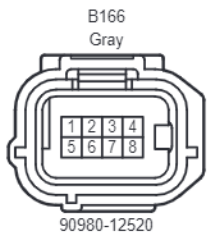
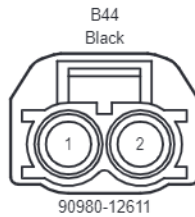
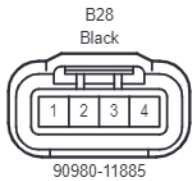
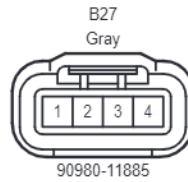
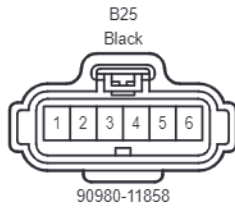
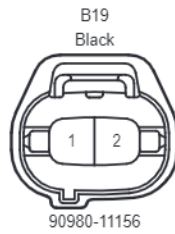
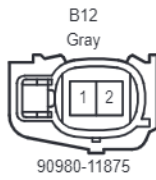
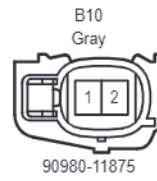
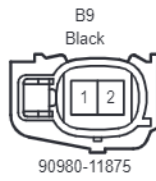
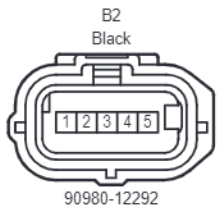

Position of Parts in Engine Compartment <RHD>

B178  
Black

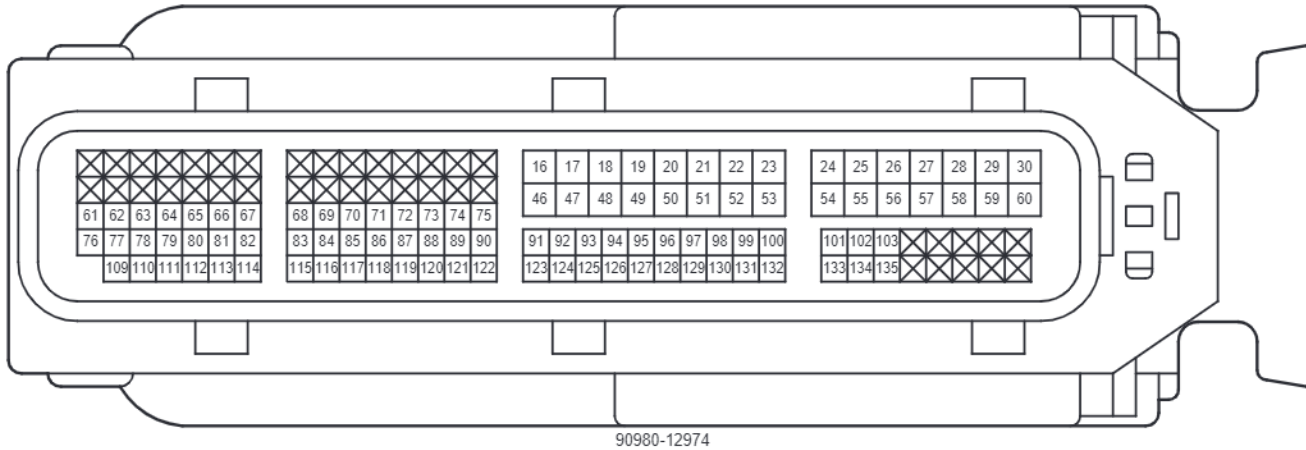

90980-12974

B179  
Black

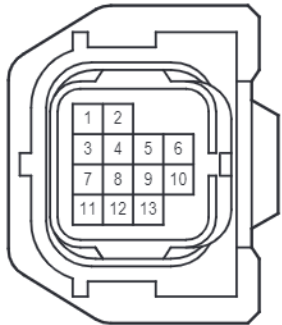

G9266-47010

Position of Parts in Engine Compartment <RHD>

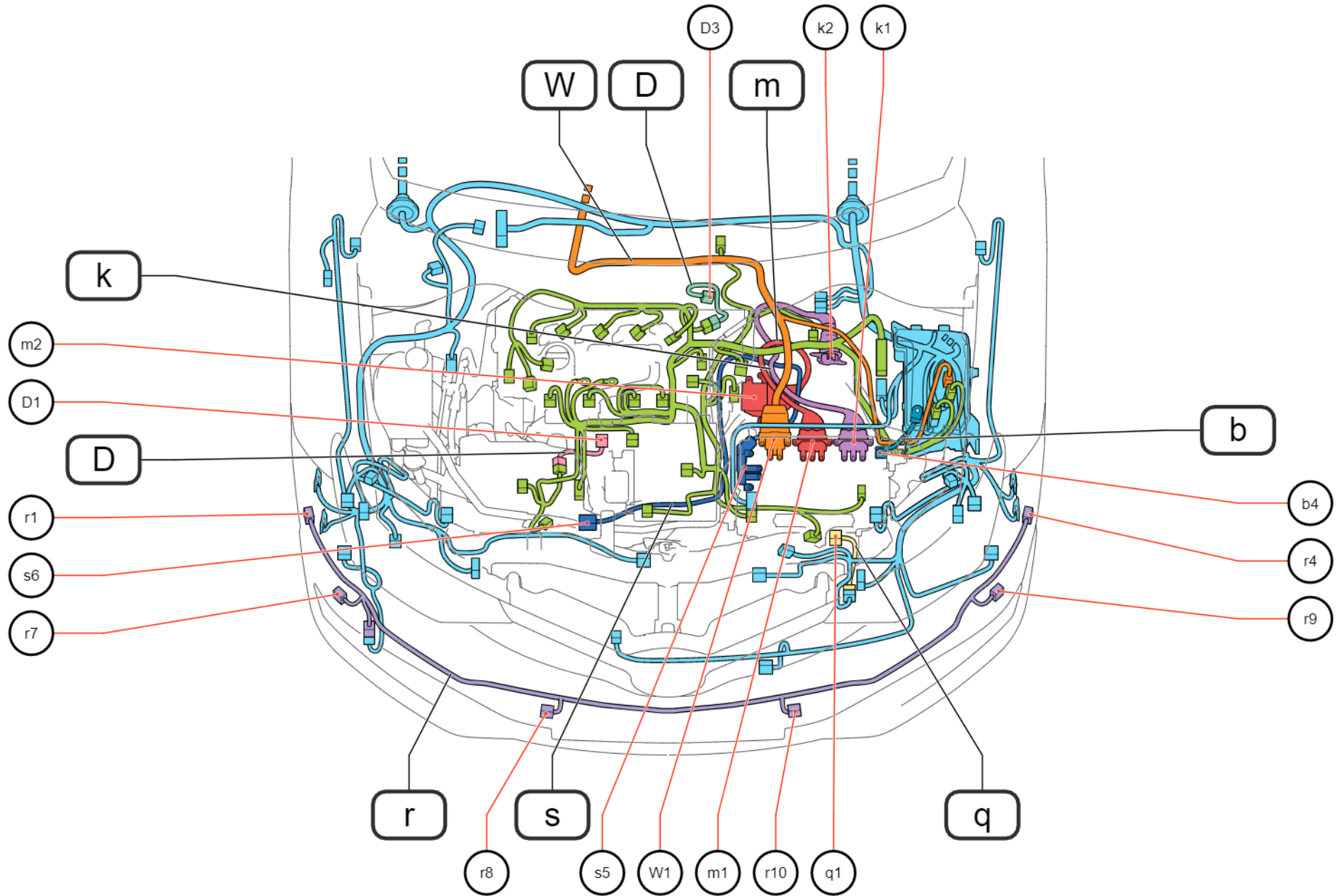

Position of Parts in Engine Compartment <RHD>

---

- D 1 Knock Control Sensor (Bank 1)
- D 3 Engine Coolant Temperature Sensor
  
- W 1 Inverter with Converter Assembly
  
- b 4 Inverter with Converter Assembly
  
- k 1 Inverter with Converter Assembly
- k 2 Hybrid Vehicle Generator Assembly
  
- m 1 Inverter with Converter Assembly
- m 2 Hybrid Vehicle Generator Assembly
  
- q 1 Water Pump with Motor Assembly
  
- r 1 Front No. 1 Ultrasonic Sensor RH Side
- r 4 Front No. 1 Ultrasonic Sensor LH Side
- r 7 Front No. 1 Ultrasonic Sensor RH
- r 8 Front No. 1 Ultrasonic Sensor RH Center
- r 9 Front No. 1 Ultrasonic Sensor LH
- r 10 Front No. 1 Ultrasonic Sensor LH Center
  
- s 5 Compressor with Motor Assembly
- s 6 Inverter with Converter Assembly



Position of Parts in Engine Compartment <RHD>

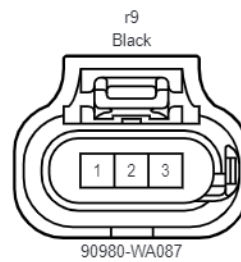
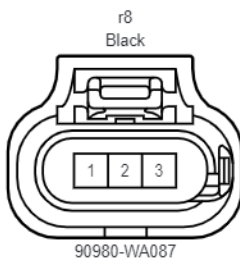
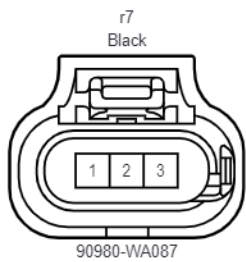
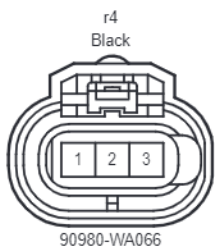
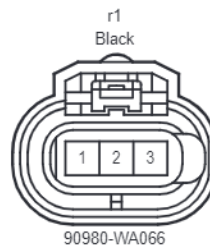
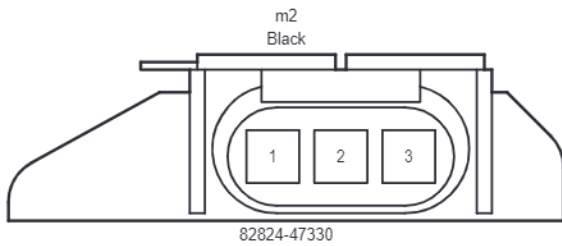
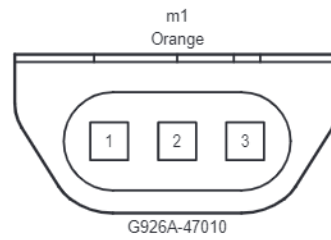
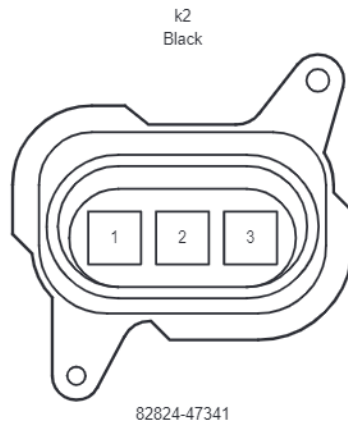
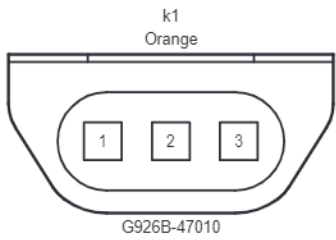
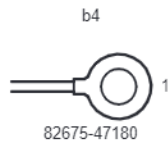
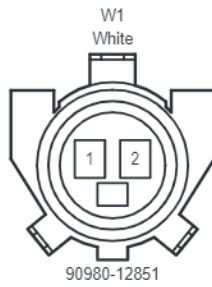

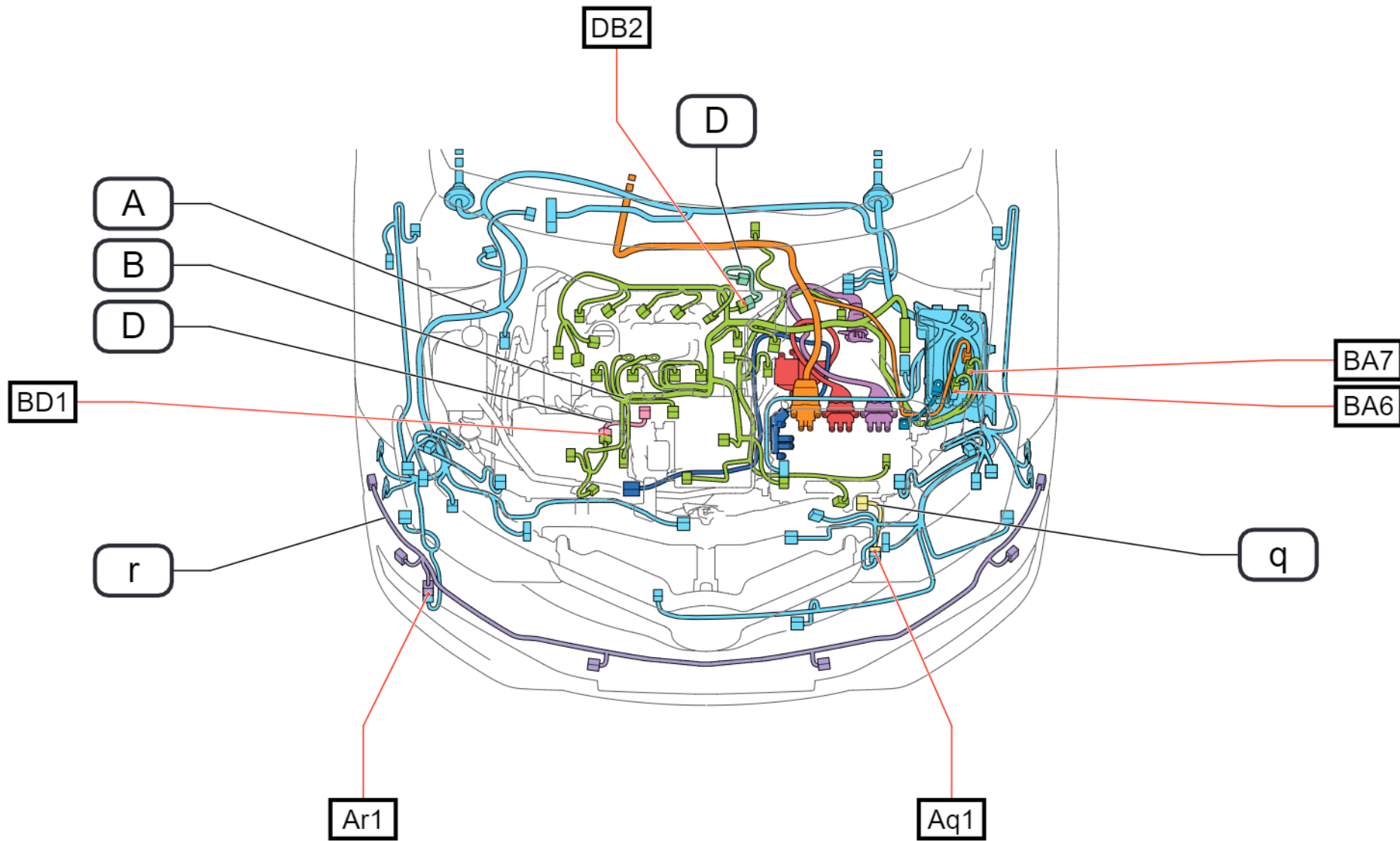

Wire and Wire in Engine Compartment <RHD>

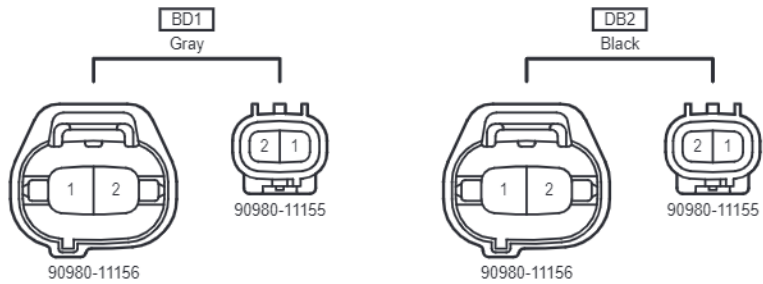
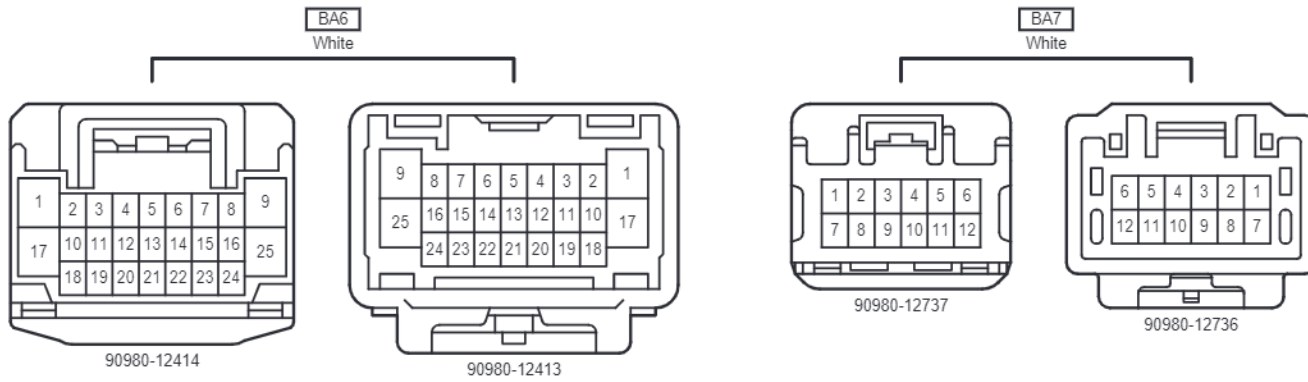
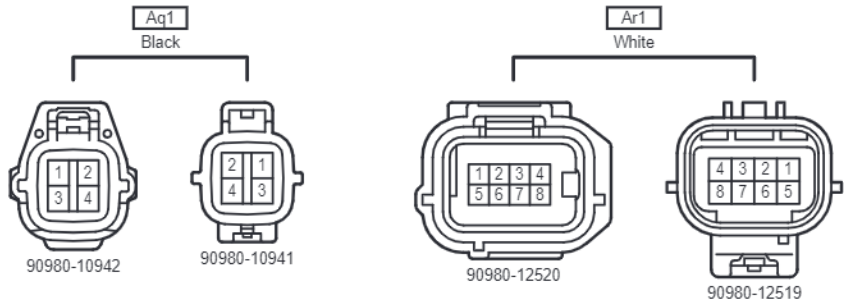

Ground Points in Luggage Room <LHD H/B>

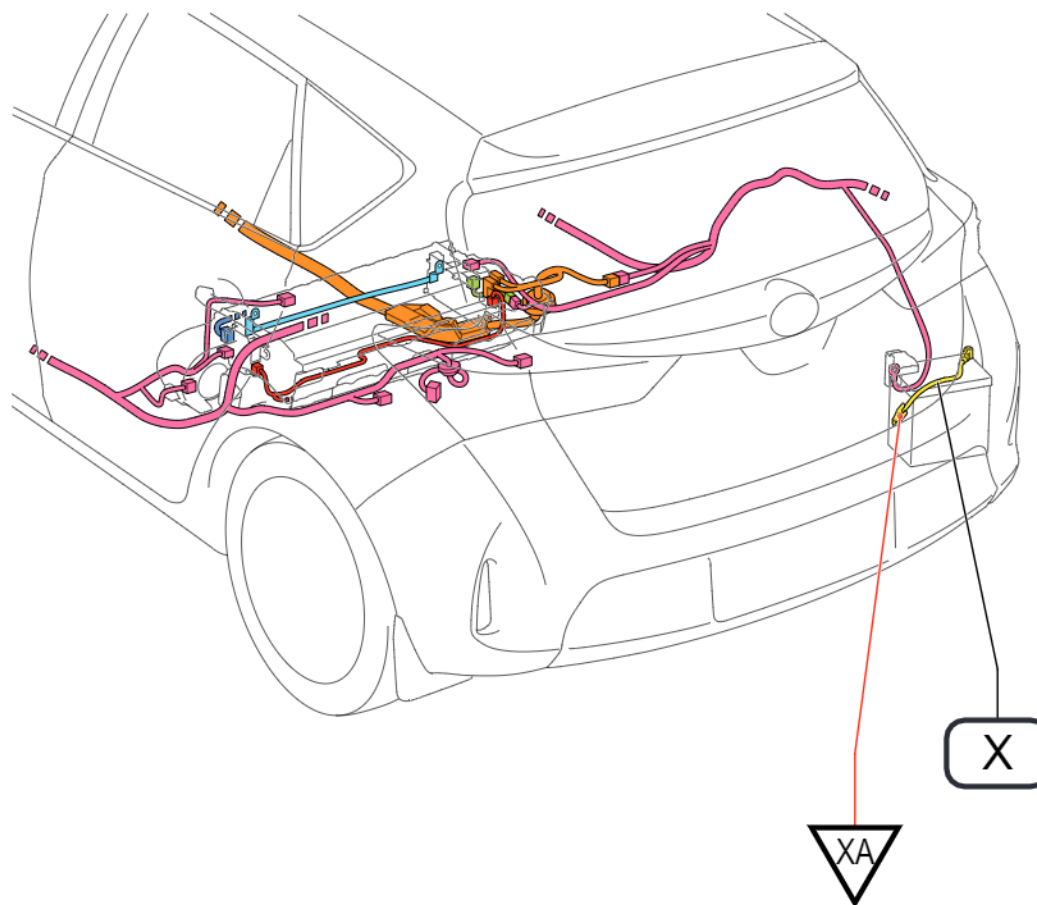

Position of Parts in Luggage Room <LHD H/B>

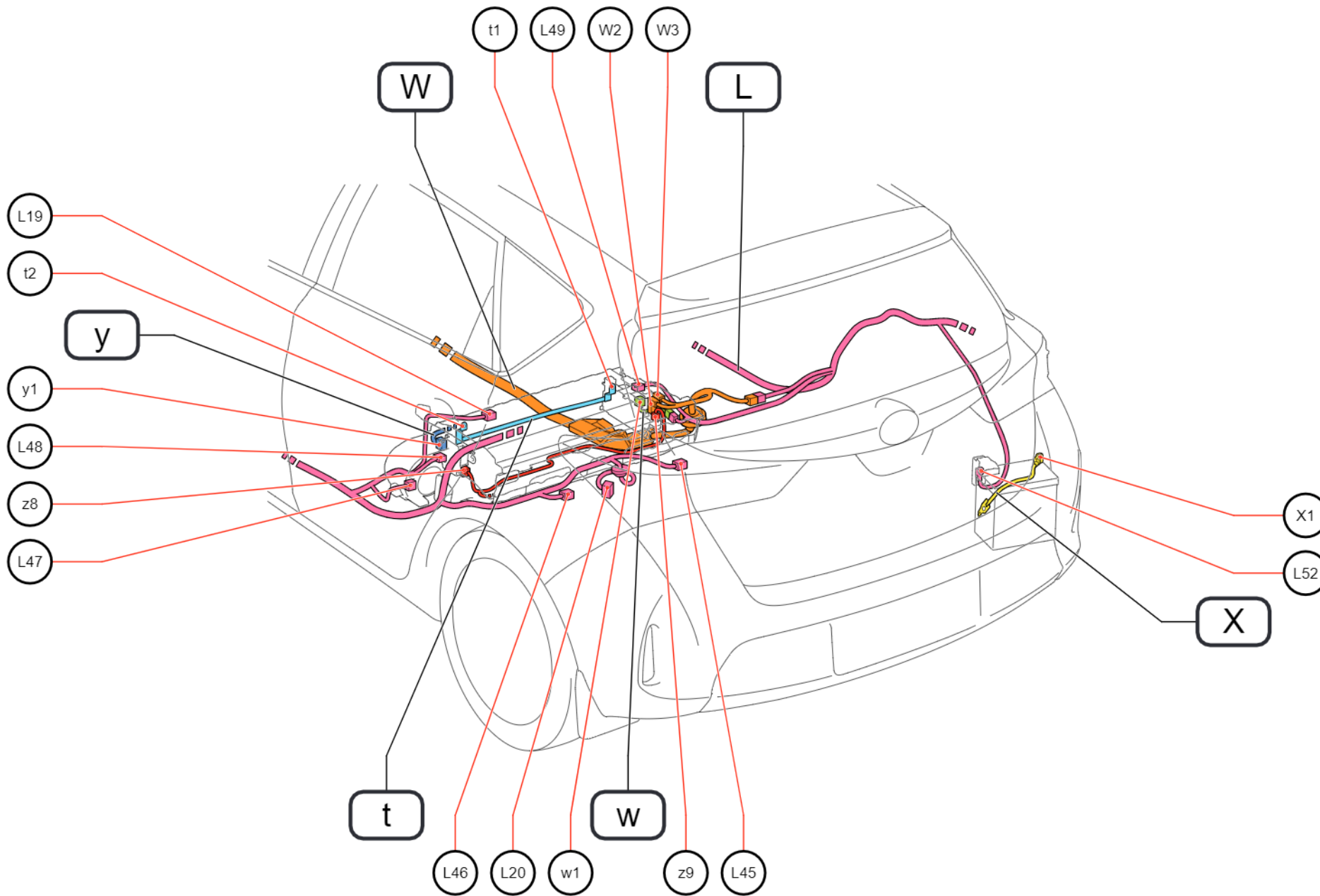

Position of Parts in Luggage Room <LHD H/B>

---

- L 19 No. 2 Indoor Electrical Key Antenna Assembly
- L 20 Fuel Suction Tube with Pump & Gage Assembly
- L 45 Rear No. 1 Seat Inner Belt Assembly RH
- L 46 Rear Seat Inner Belt with Center Assembly LH
- L 47 Battery Cooling Blower Assembly
- L 48 Battery Voltage Sensor
- L 49 Hybrid Battery Junction Block Assembly
- L 52 Fusible Link Block Assembly

- W 2 Hybrid Battery Junction Block Assembly
- W 3 Hybrid Battery Junction Block Assembly

- X 1 Battery

- t 1 Hybrid Battery Junction Block Assembly
- t 2 HV Supply Battery Assembly

- w 1 Interlock Switch (Service Plug Grip)

- y 1 Battery Voltage Sensor

- z 8 Battery Voltage Sensor
- z 9 Hybrid Battery Junction Block Assembly

Position of Parts in Luggage Room <LHD H/B>

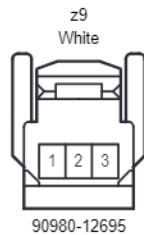
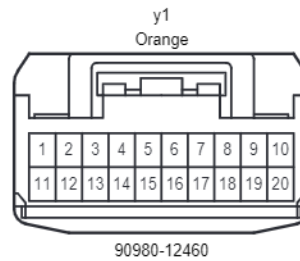
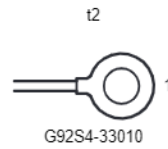
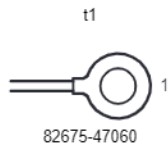
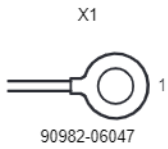
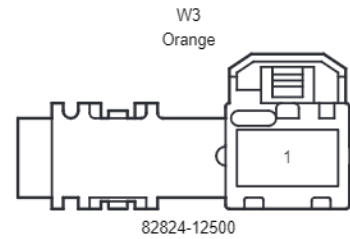
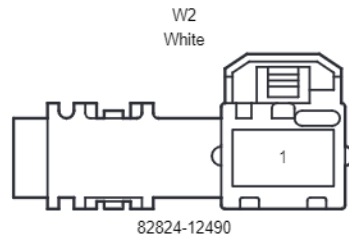
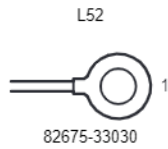
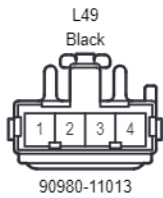
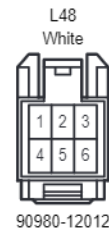
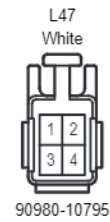
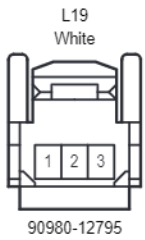

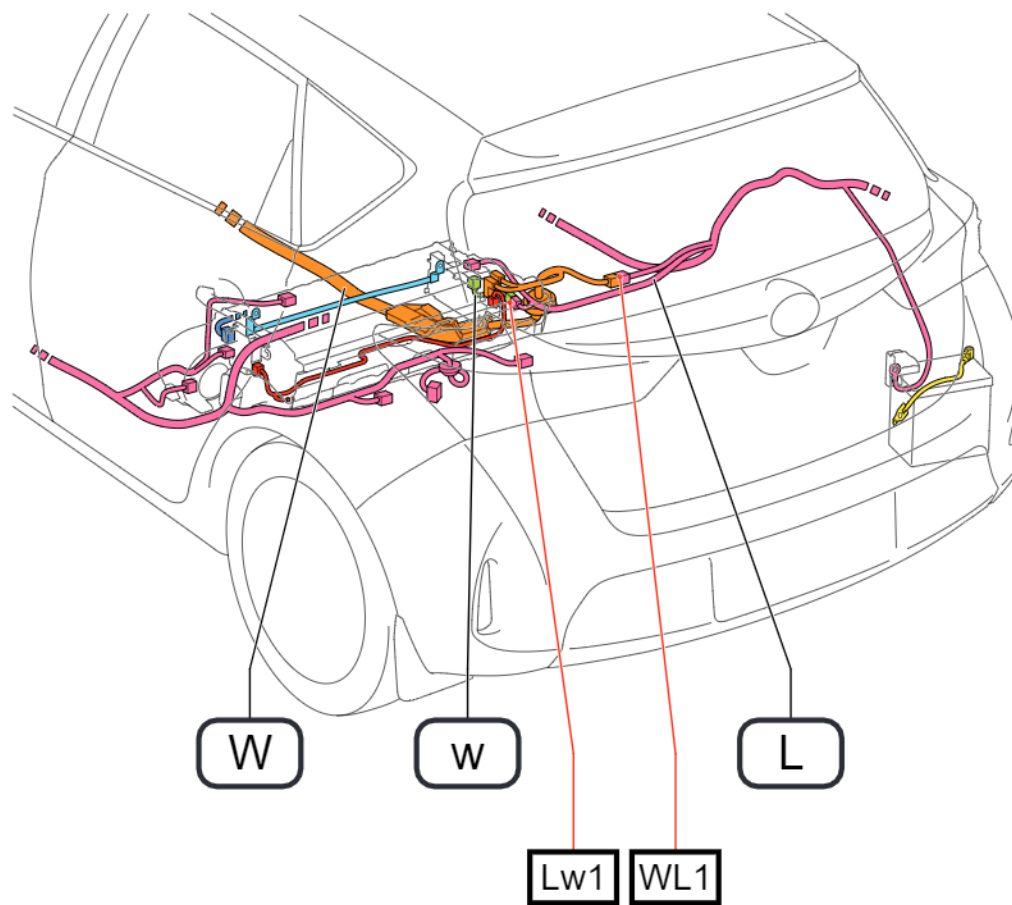



Wire and Wire in Luggage Room <LHD H/B>

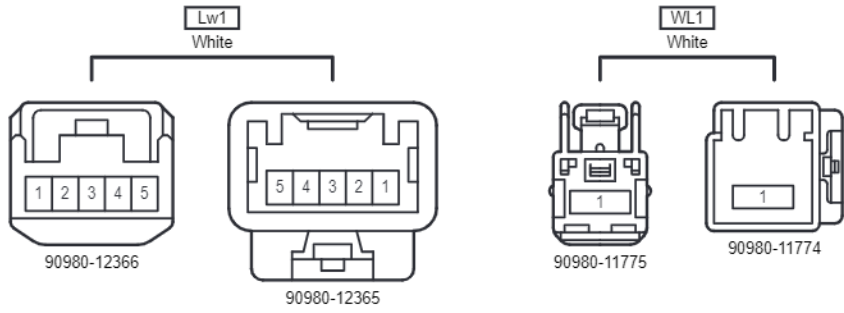

Ground Points in Luggage Room <LHD W/G>

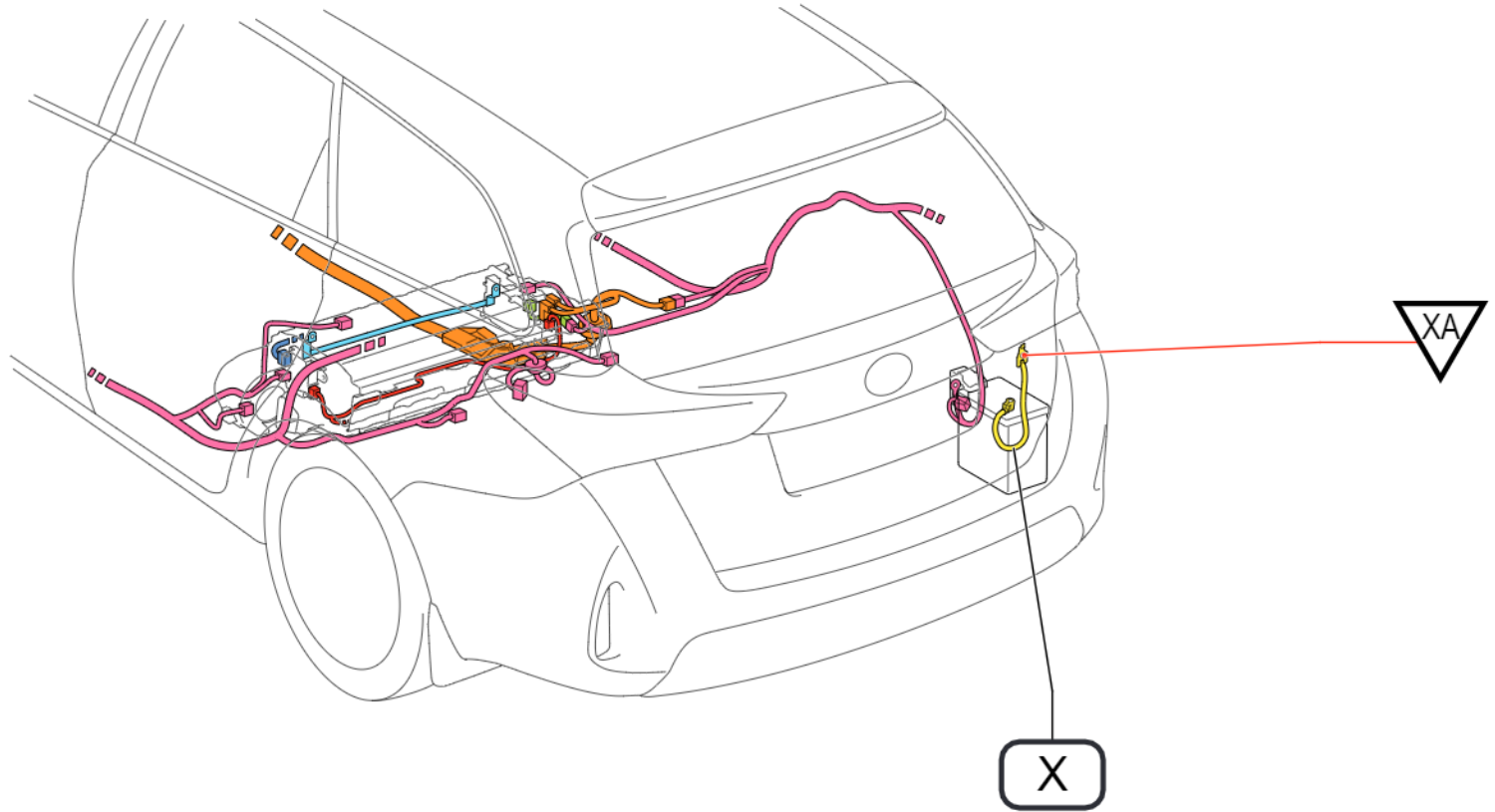

Position of Parts in Luggage Room <LHD W/G>

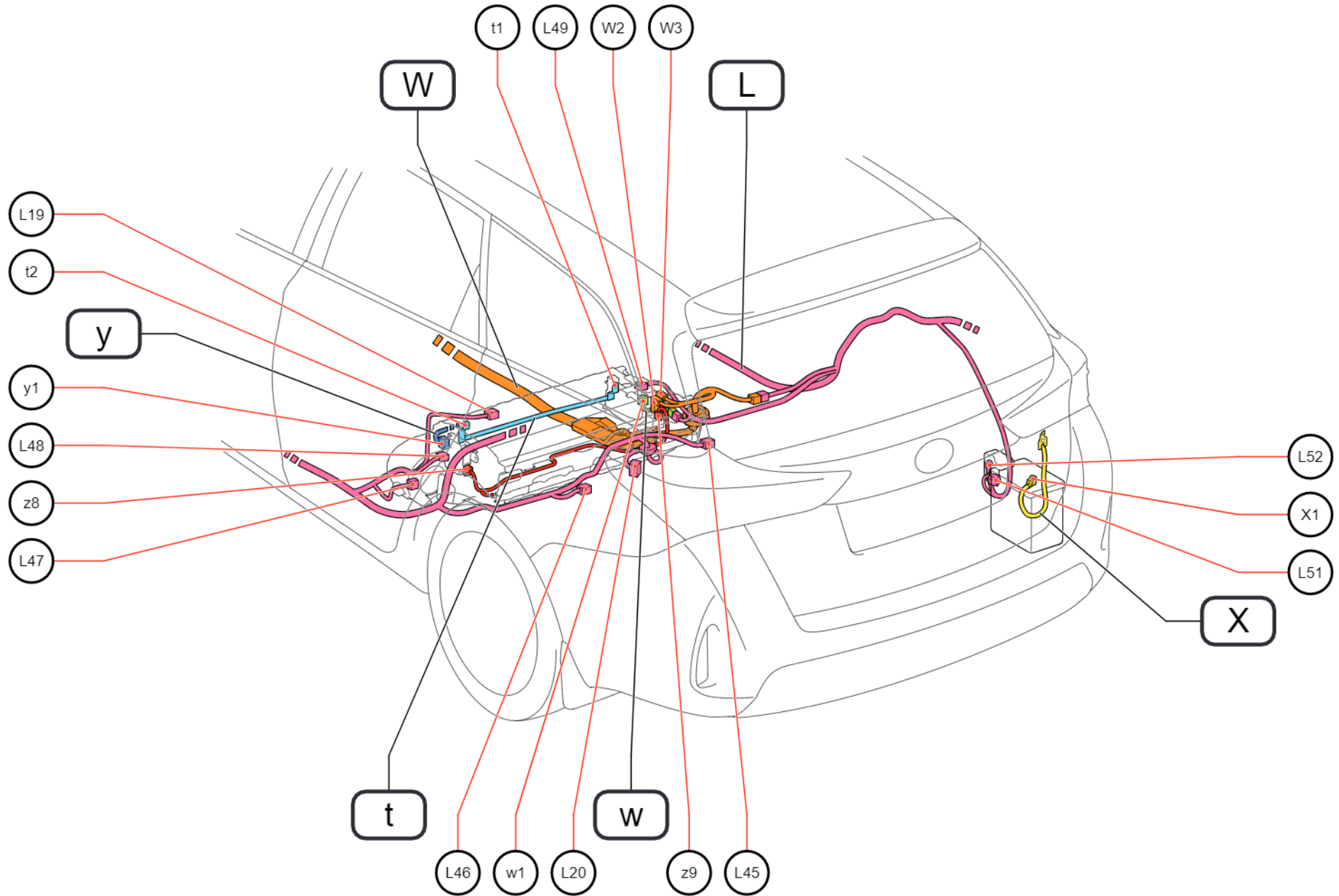

Position of Parts in Luggage Room <LHD W/G>

---

- L 19 No. 2 Indoor Electrical Key Antenna Assembly
- L 20 Fuel Suction Tube with Pump & Gage Assembly
- L 45 Rear No. 1 Seat Inner Belt Assembly RH
- L 46 Rear Seat Inner Belt with Center Assembly LH
- L 47 Battery Cooling Blower Assembly
- L 48 Battery Voltage Sensor
- L 49 Hybrid Battery Junction Block Assembly
- L 51 Battery Thermometer Sensor
- L 52 Fusible Link Block Assembly
  
- W 2 Hybrid Battery Junction Block Assembly
- W 3 Hybrid Battery Junction Block Assembly
  
- X 1 Battery
  
- t 1 Hybrid Battery Junction Block Assembly
- t 2 HV Supply Battery Assembly
  
- w 1 Interlock Switch (Service Plug Grip)
  
- y 1 Battery Voltage Sensor
  
- z 8 Battery Voltage Sensor
- z 9 Hybrid Battery Junction Block Assembly

Position of Parts in Luggage Room <LHD W/G>

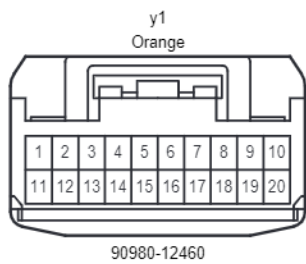
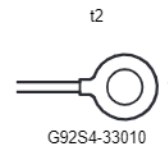
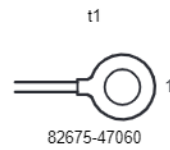
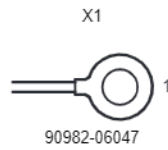
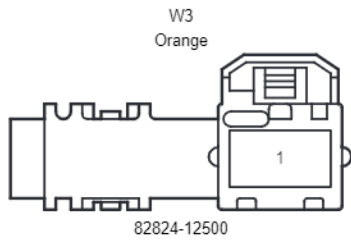
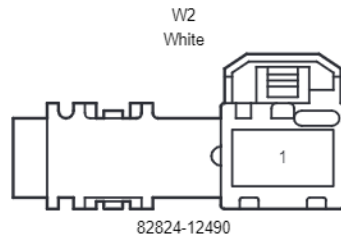
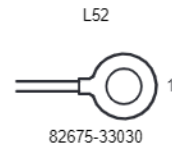
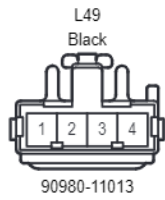
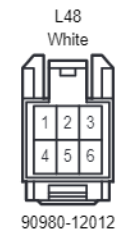
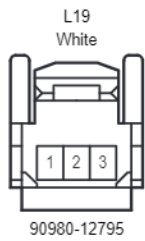

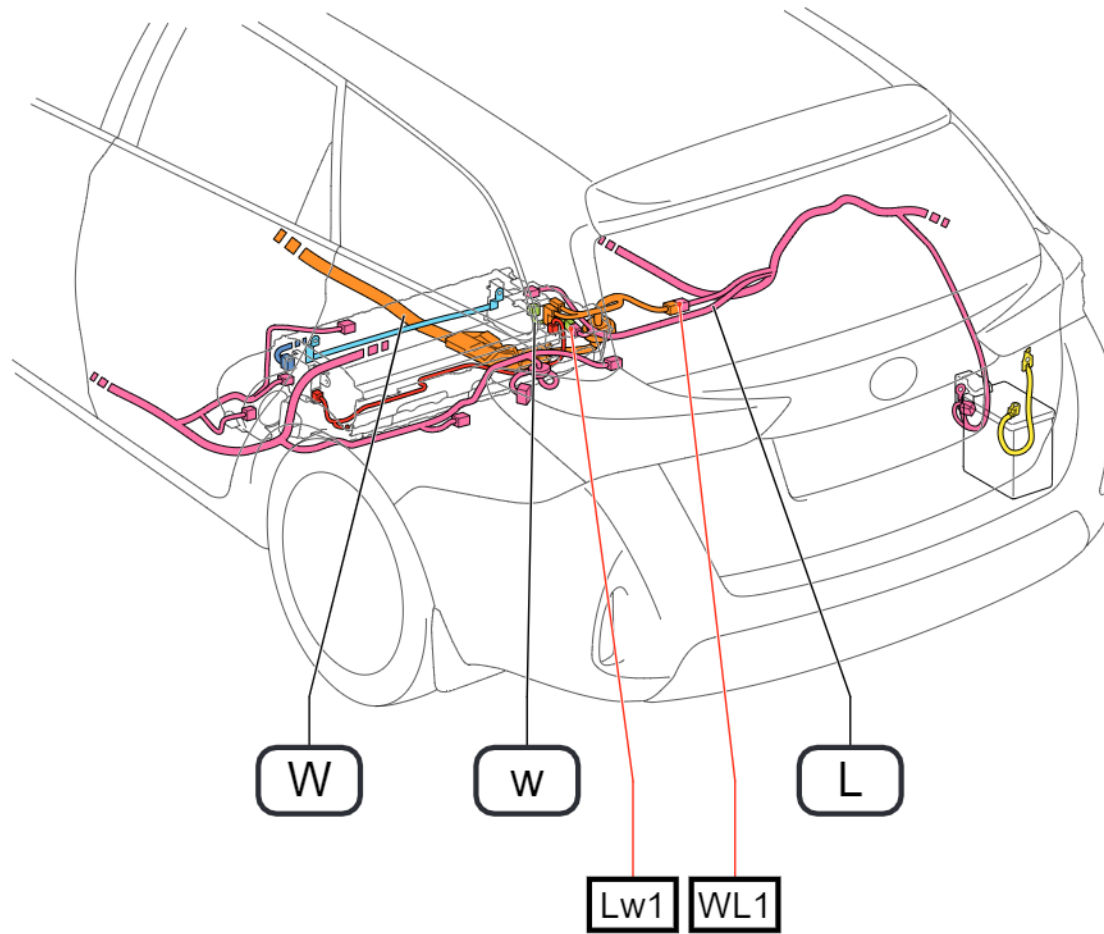

Wire and Wire in Luggage Room <LHD W/G>

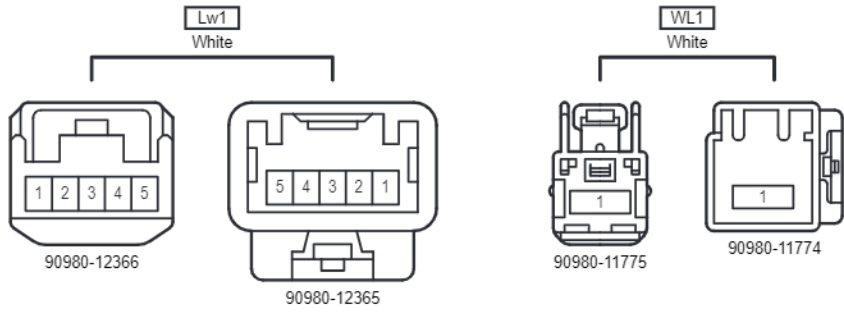

Ground Points in Luggage Room <RHD H/B>

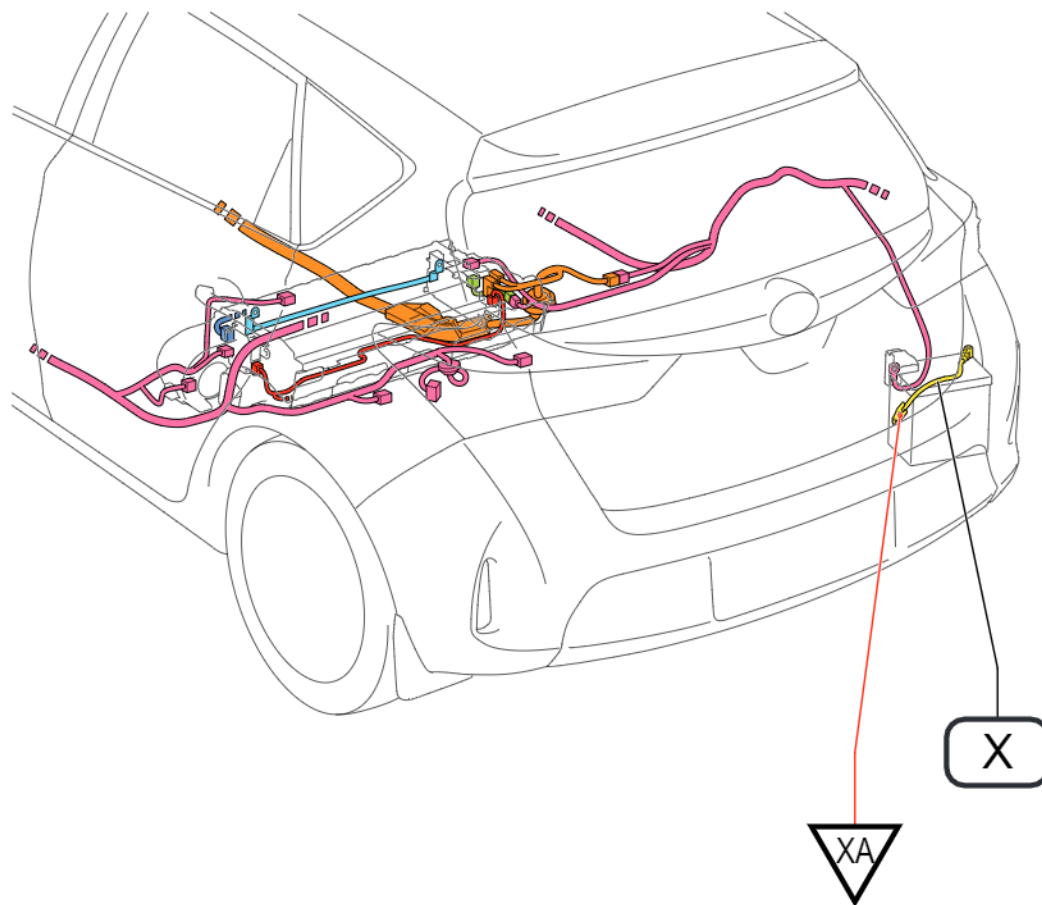



Position of Parts in Luggage Room <RHD H/B>

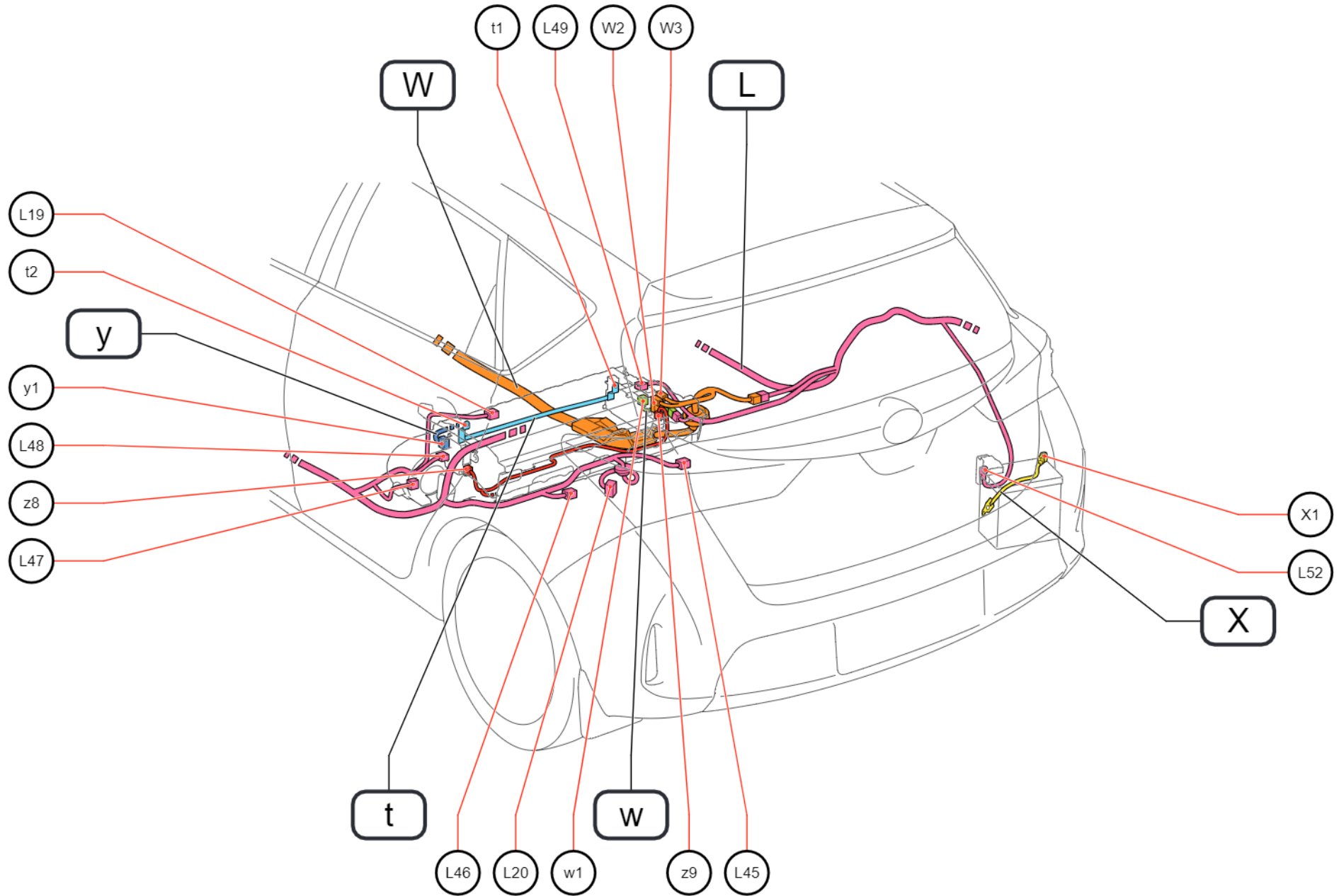

Position of Parts in Luggage Room <RHD H/B>

---

- L 19 No. 2 Indoor Electrical Key Antenna Assembly
- L 20 Fuel Suction Tube with Pump & Gage Assembly
- L 45 Rear No. 1 Seat Inner Belt Assembly RH
- L 46 Rear Seat Inner Belt with Center Assembly LH
- L 47 Battery Cooling Blower Assembly
- L 48 Battery Voltage Sensor
- L 49 Hybrid Battery Junction Block Assembly
- L 52 Fusible Link Block Assembly

- W 2 Hybrid Battery Junction Block Assembly
- W 3 Hybrid Battery Junction Block Assembly

- X 1 Battery

- t 1 Hybrid Battery Junction Block Assembly
- t 2 HV Supply Battery Assembly

- w 1 Interlock Switch (Service Plug Grip)

- y 1 Battery Voltage Sensor

- z 8 Battery Voltage Sensor
- z 9 Hybrid Battery Junction Block Assembly

Position of Parts in Luggage Room <RHD H/B>

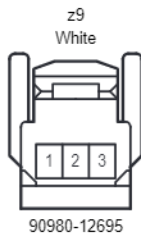
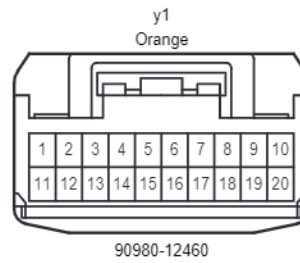
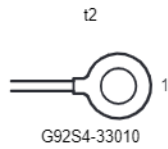
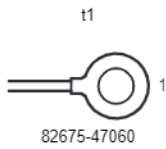
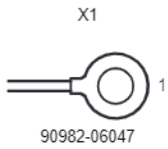
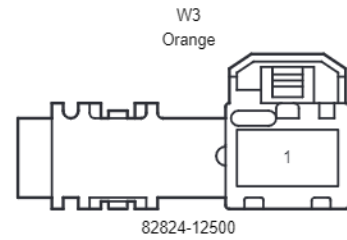
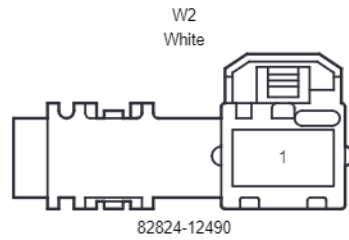
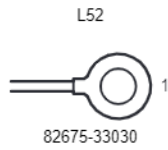
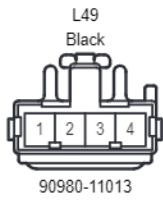
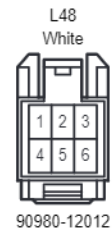
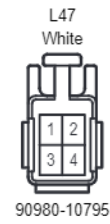
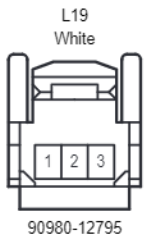

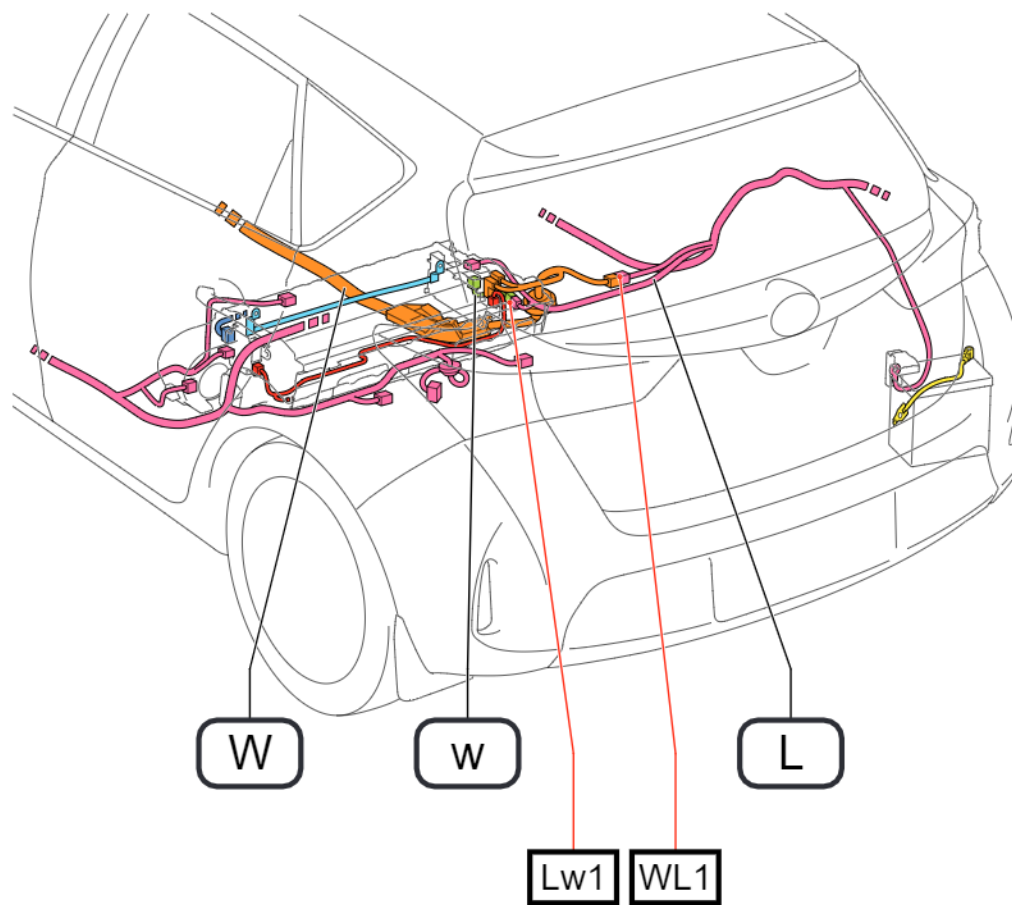

Wire and Wire in Luggage Room <RHD H/B>

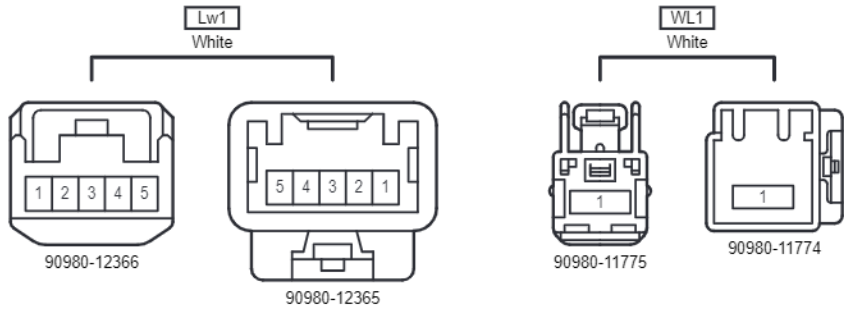

Ground Points in Luggage Room <RHD W/G>

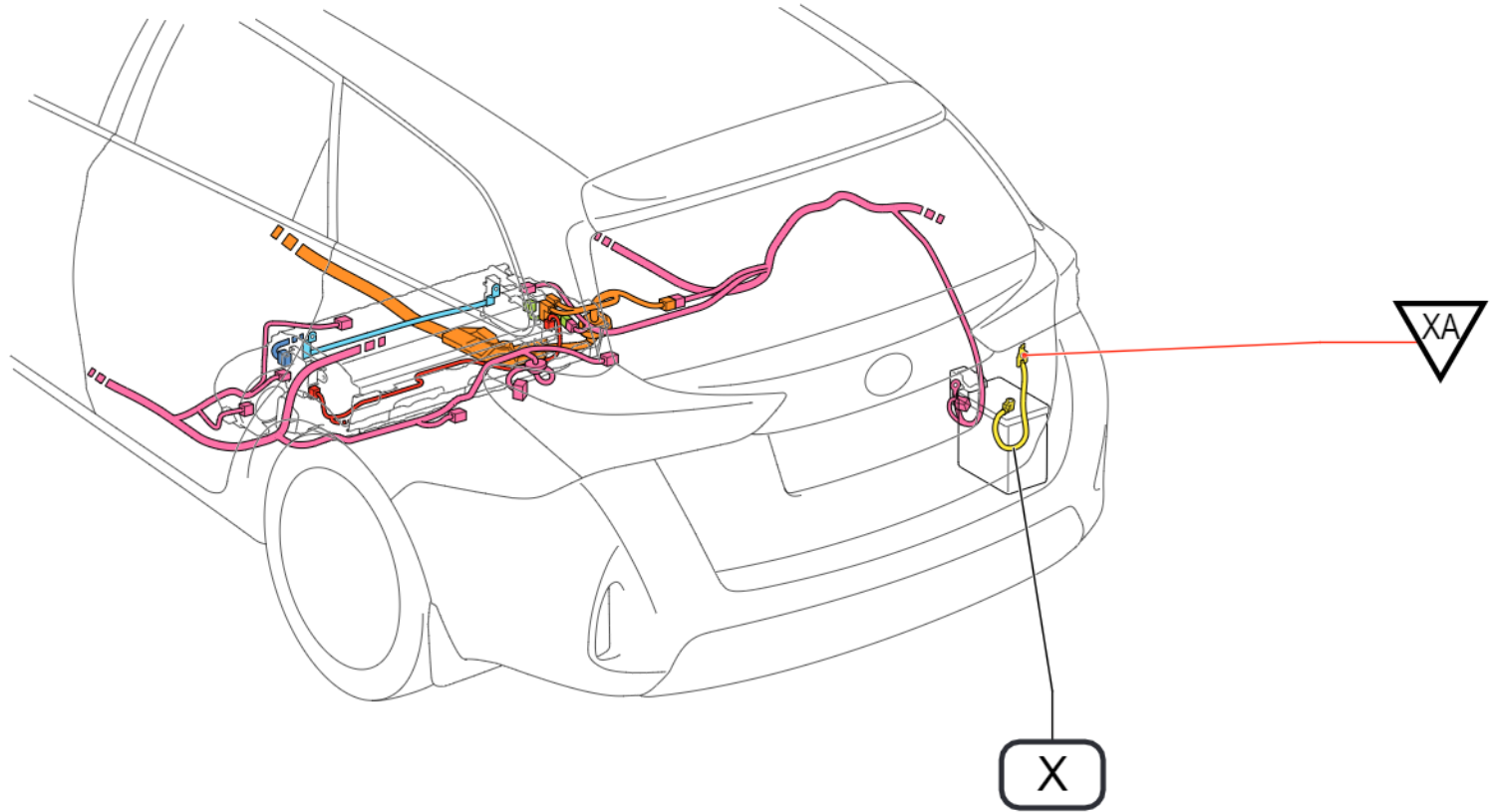

Position of Parts in Luggage Room <RHD W/G>

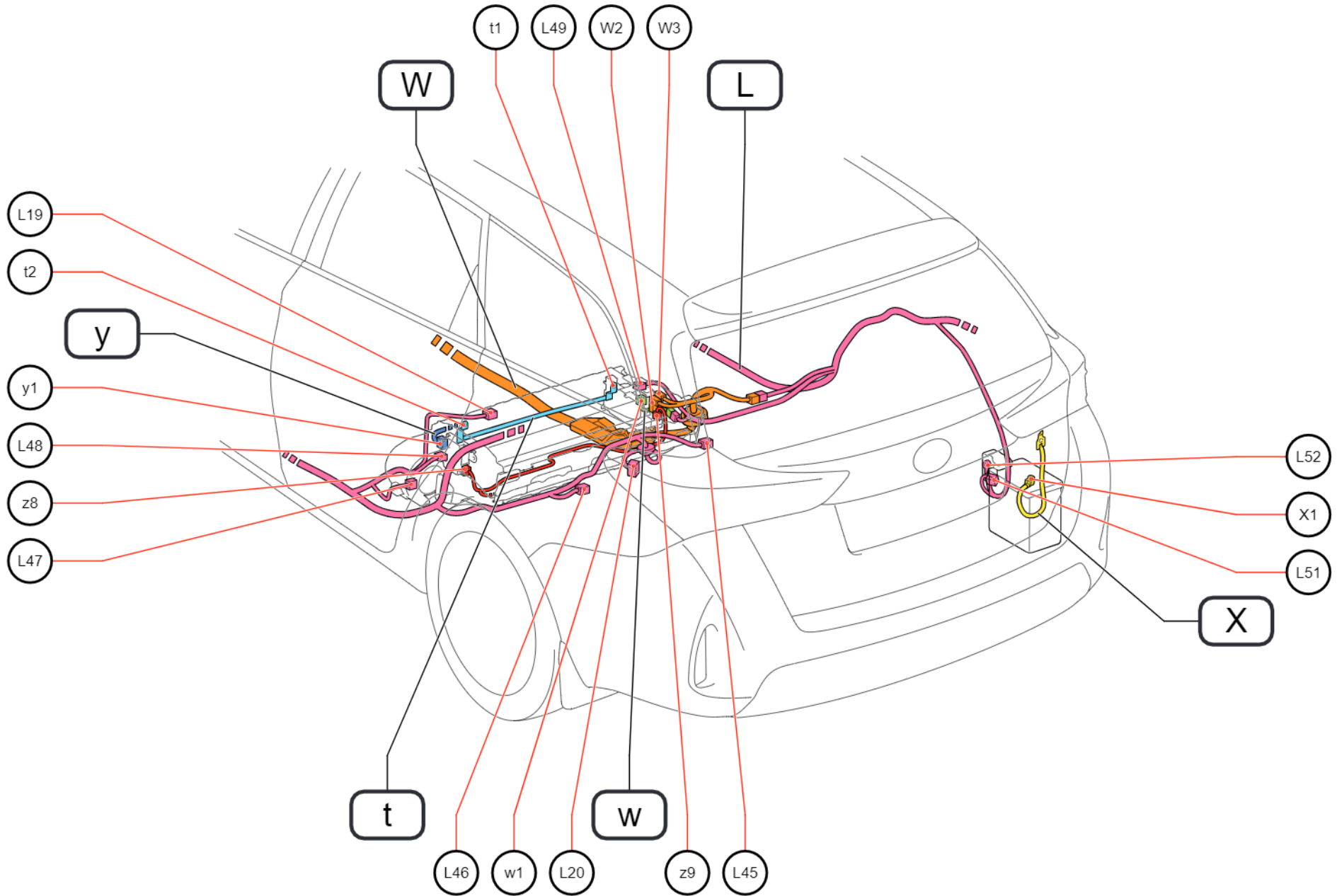

Position of Parts in Luggage Room <RHD W/G>

---

- L 19 No. 2 Indoor Electrical Key Antenna Assembly
- L 20 Fuel Suction Tube with Pump & Gage Assembly
- L 45 Rear No. 1 Seat Inner Belt Assembly RH
- L 46 Rear Seat Inner Belt with Center Assembly LH
- L 47 Battery Cooling Blower Assembly
- L 48 Battery Voltage Sensor
- L 49 Hybrid Battery Junction Block Assembly
- L 51 Battery Thermometer Sensor
- L 52 Fusible Link Block Assembly
  
- W 2 Hybrid Battery Junction Block Assembly
- W 3 Hybrid Battery Junction Block Assembly
  
- X 1 Battery
  
- t 1 Hybrid Battery Junction Block Assembly
- t 2 HV Supply Battery Assembly
  
- w 1 Interlock Switch (Service Plug Grip)
  
- y 1 Battery Voltage Sensor
  
- z 8 Battery Voltage Sensor
- z 9 Hybrid Battery Junction Block Assembly



Position of Parts in Luggage Room <RHD W/G>

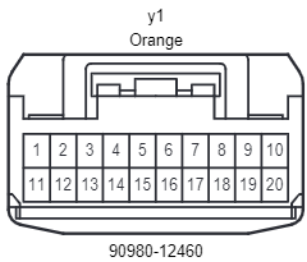
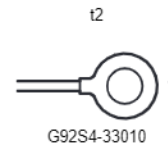
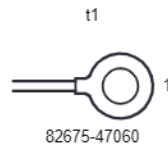
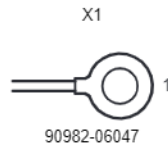
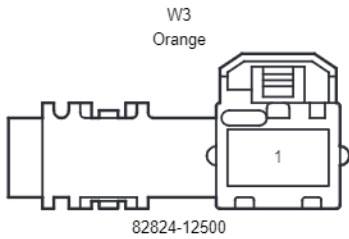
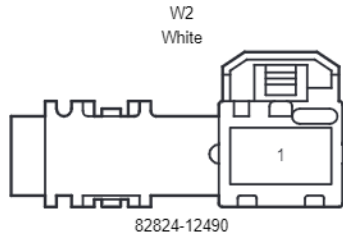
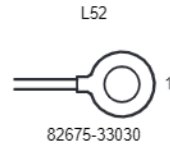
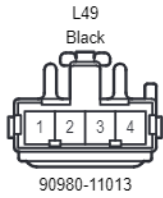
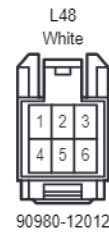
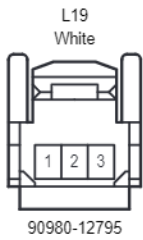

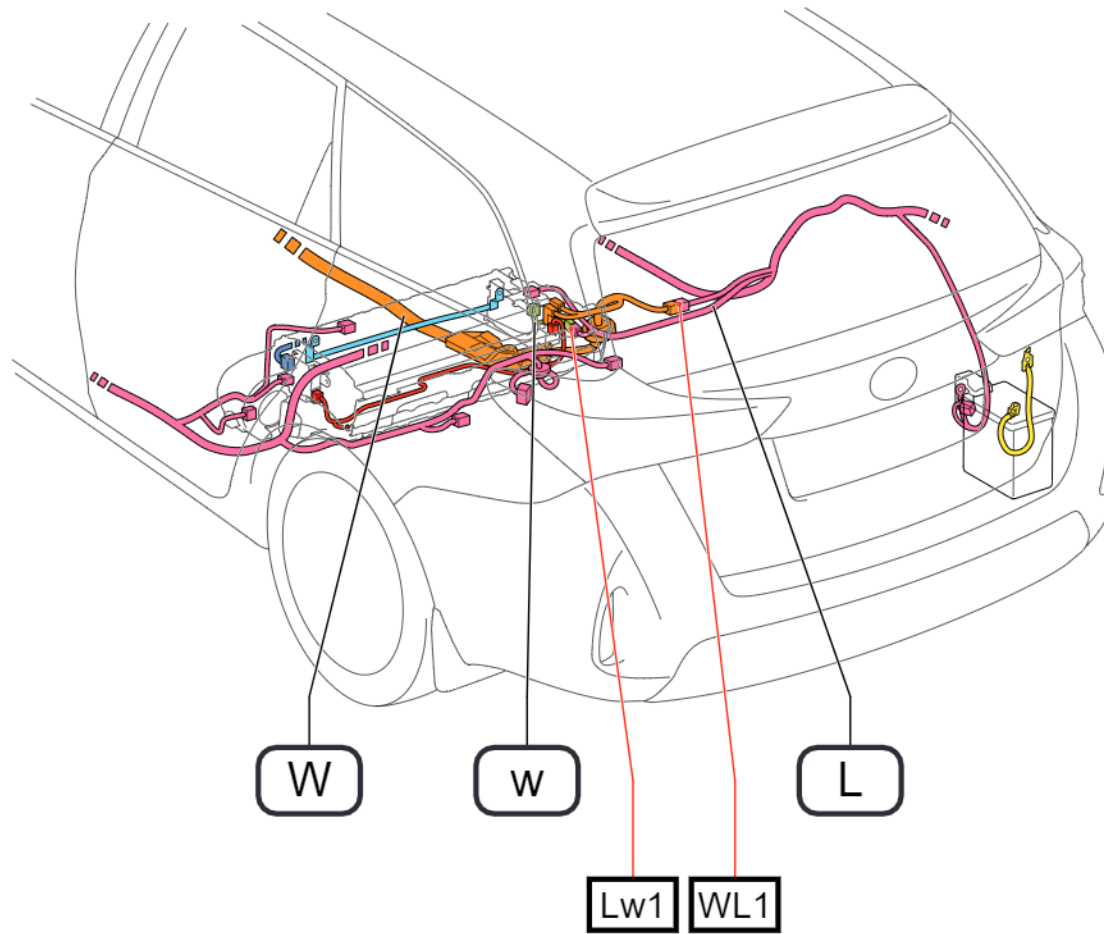

Wire and Wire in Luggage Room <RHD W/G>

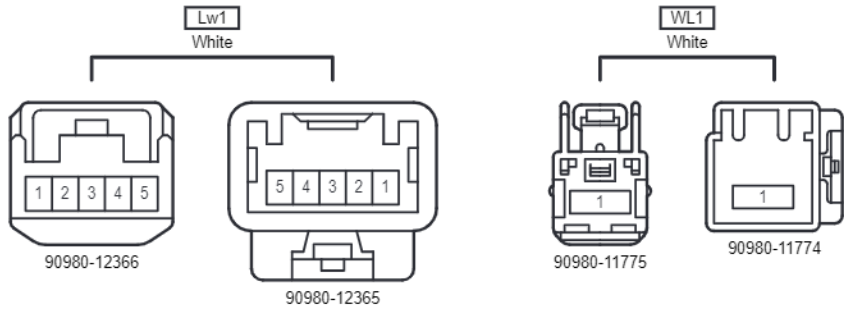

Ground Points in Instrument Panel <LHD>

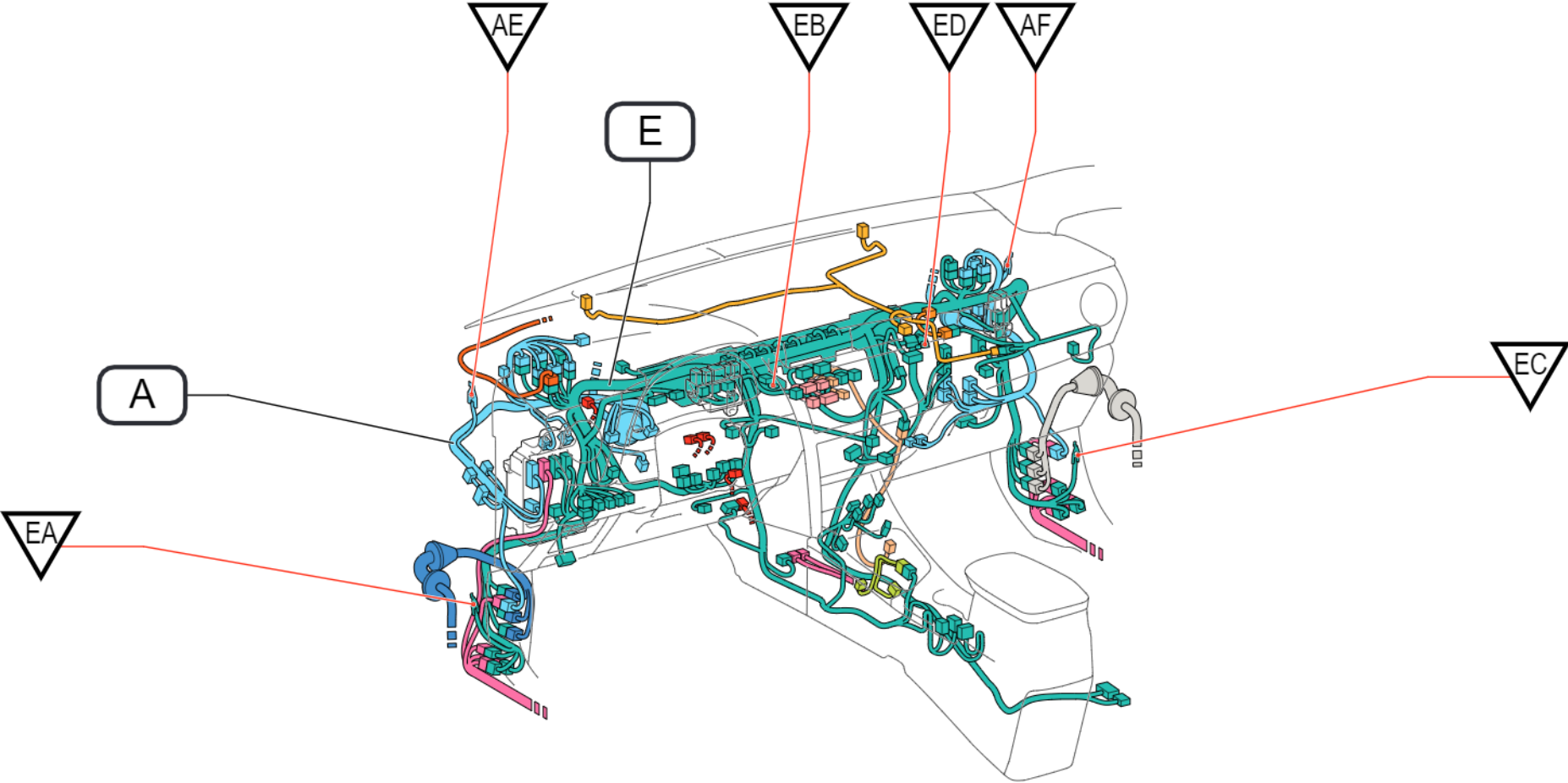

Position of Parts in Instrument Panel <LHD>

- \*2 : w/ Adaptive Front-Lighting System
- \*3 : w/o Adaptive Front-Lighting System
- \*6 : Prior May 2015
- \*7 : May 2015 or later
- \*8 : Radio & Display Receiver Assembly Type
- \*9 : Radio Receiver Assembly Type

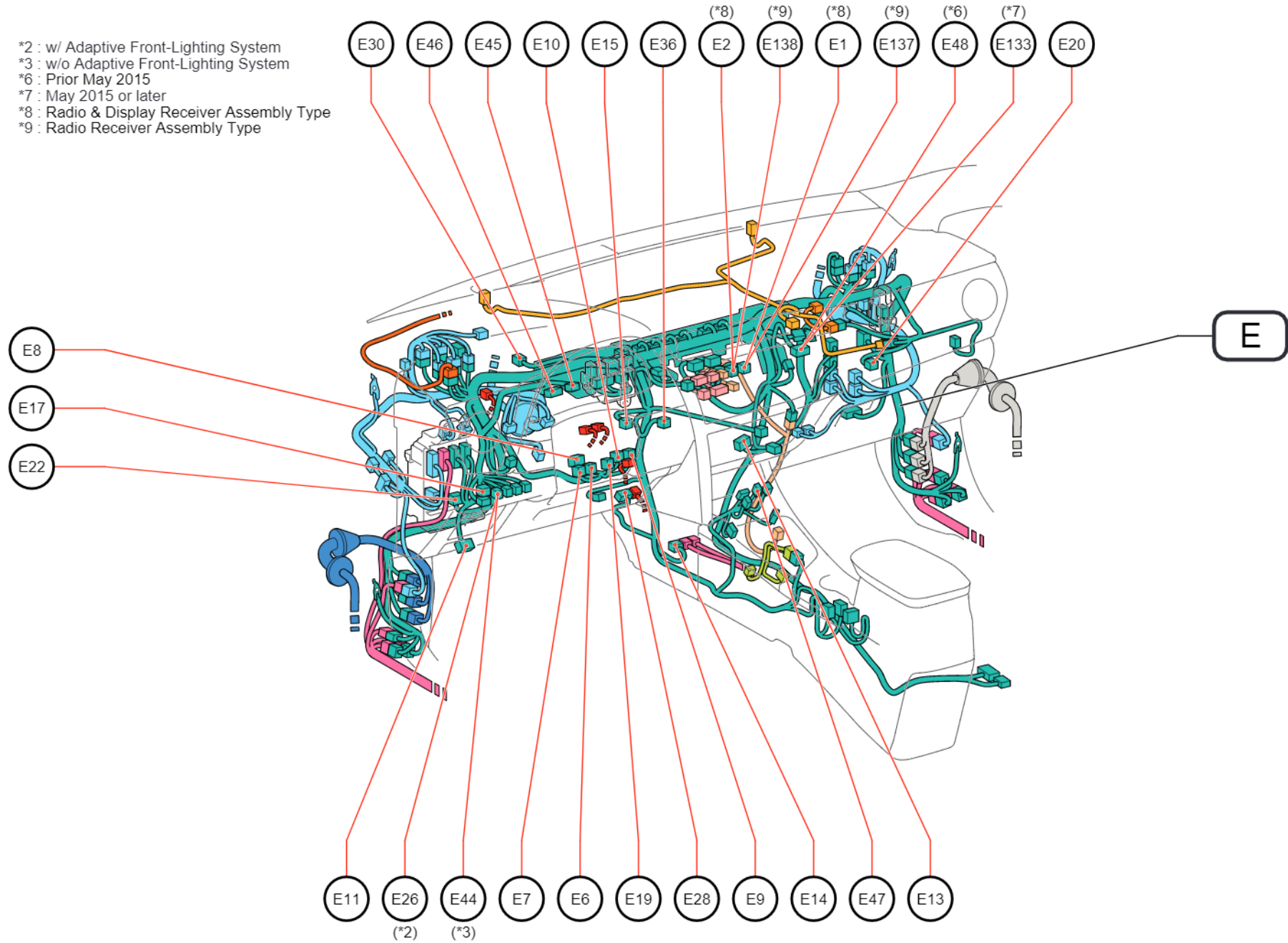

Position of Parts in Instrument Panel <LHD>

---

- E 1 Radio & Display Receiver Assembly
- E 2 Radio & Display Receiver Assembly
- E 6 Spiral Cable Sub-Assembly
- E 7 Spiral Cable Sub-Assembly
- E 8 Headlight Dimmer Switch Assembly
- E 9 Windshield Wiper Switch Assembly
- E 10 Windshield Wiper Switch Assembly
- E 11 DLC3
- E 13 Blower Motor with Fan Sub-Assembly
- E 14 Airbag Sensor Assembly
- E 15 Cooler Thermistor (Room Temperature Sensor)
- E 17 Outer Mirror Switch Assembly
- E 19 Steering Sensor (Spiral Cable with Sensor Sub-Assembly)
- E 20 Glove Box Light Assembly
- E 22 Main Body ECU
- E 26 Headlight Swivel Main Switch
- E 28 A/C Amplifier Assembly
- E 30 Power Steering ECU Assembly
- E 36 Power Switch
- E 44 Headlight Leveling Switch
- E 45 Combination Meter Assembly
- E 46 Combination Meter Assembly
- E 47 VSC Off Switch
- E 48 Telltale Light Assembly
- E 133 Clock Assembly
- E 137 Radio Receiver Assembly
- E 138 Radio Receiver Assembly

Position of Parts in Instrument Panel <LHD>

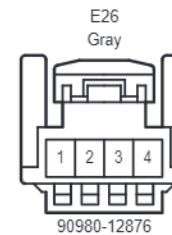
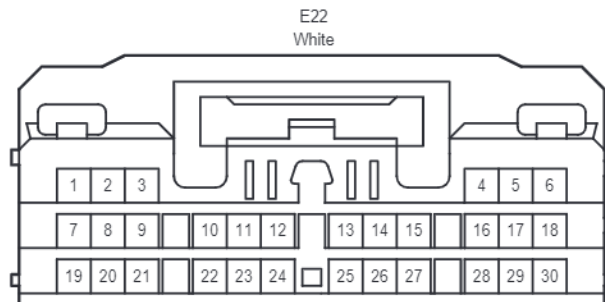
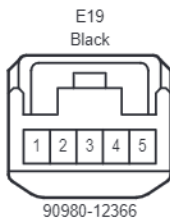
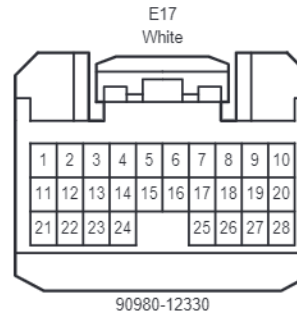
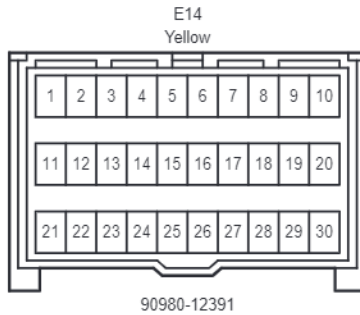
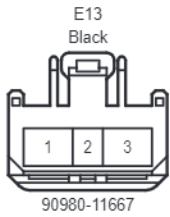
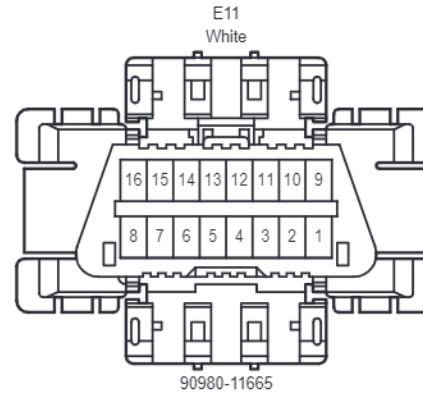
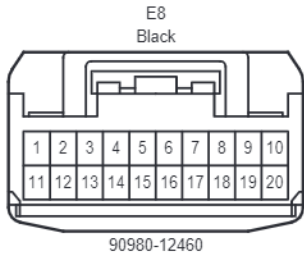
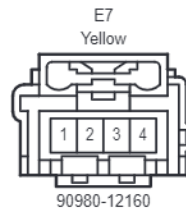
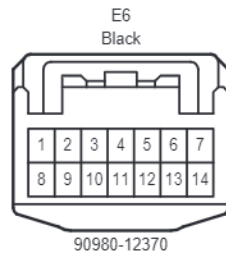

Position of Parts in Instrument Panel <LHD>

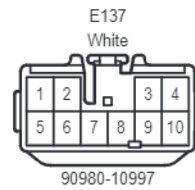
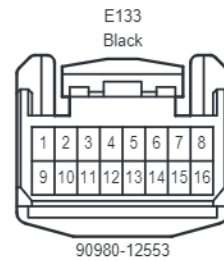
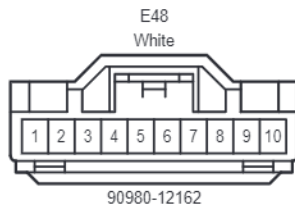
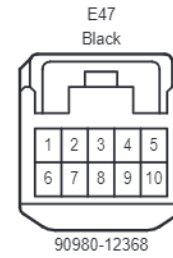
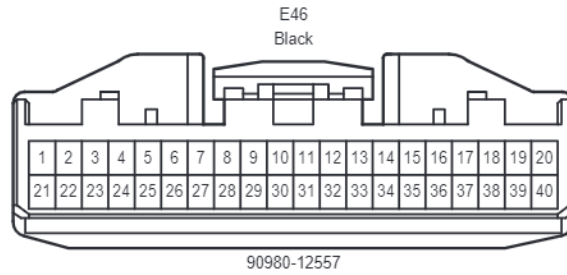
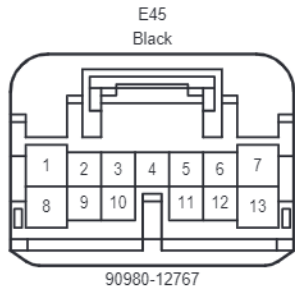
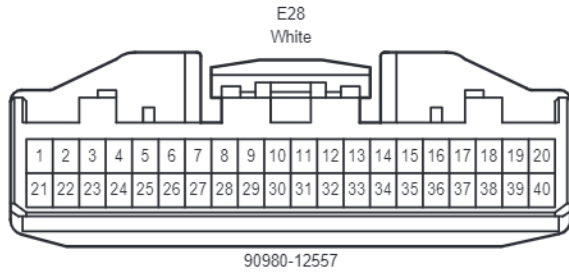



Position of Parts in Instrument Panel <LHD>

\*1 : Refer to the Service Bulletin  
for the installation position of the parts.

\*4 : Prior May 2014

\*5 : May 2014 or later

\*6 : Prior May 2015

\*7 : May 2015 or later

\*8 : Radio & Display Receiver Assembly Type

\*9 : Radio Receiver Assembly Type

\*10 : Prior November 2016

\*11 : November 2016 or later

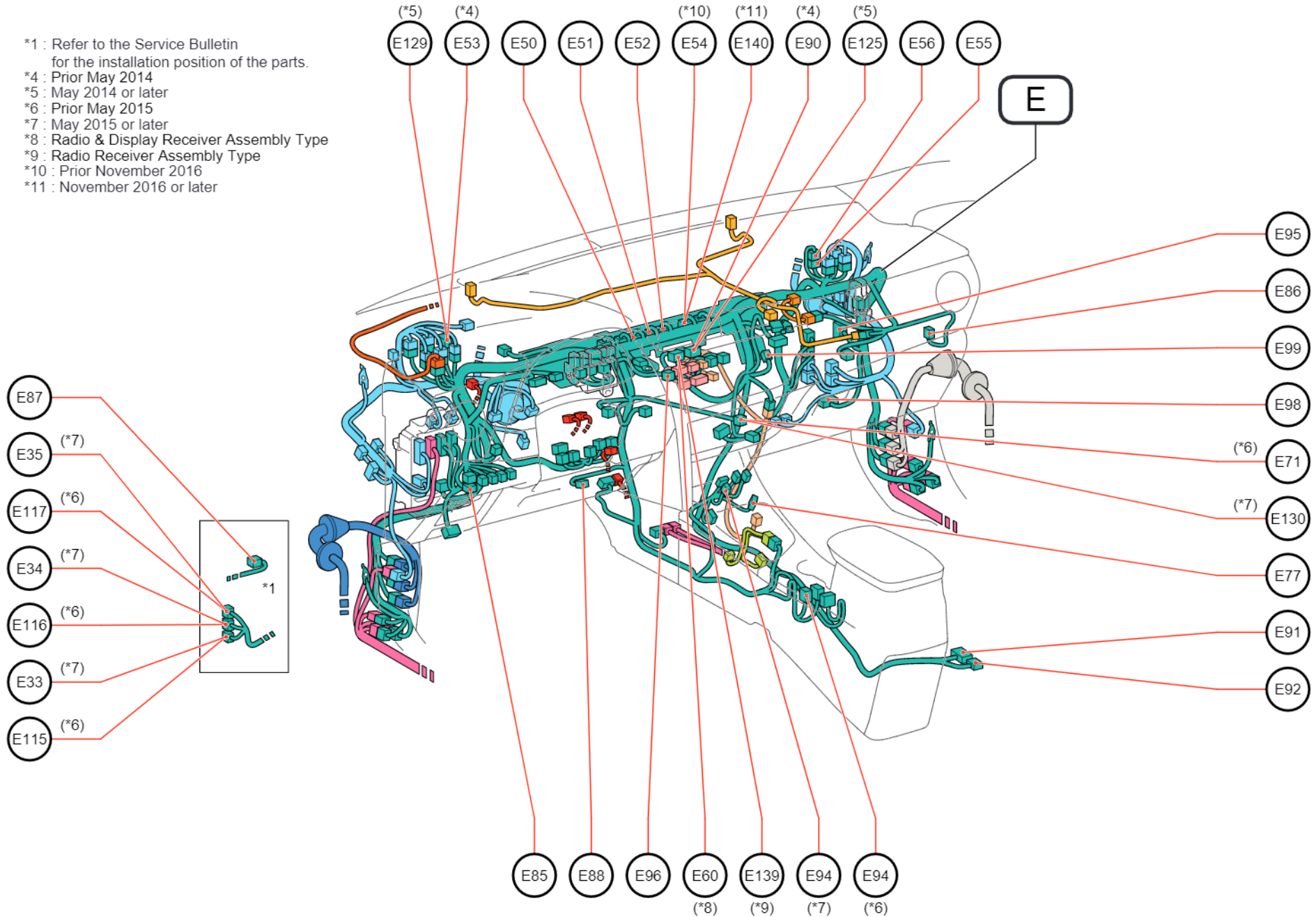

Position of Parts in Instrument Panel <LHD>

---

- E 33 Certification ECU
- E 34 Certification ECU
- E 35 Certification ECU
- E 50 No. 3 Junction Connector
- E 51 No. 4 Junction Connector
- E 52 No. 5 Junction Connector
- E 53 No. 6 Junction Connector
- E 54 No. 7 Junction Connector
- E 55 No. 8 Junction Connector
- E 56 No. 8 Junction Connector
- E 60 Radio & Display Receiver Assembly
- E 71 A/C Control Assembly
- E 77 No. 1 Power Outlet Socket Assembly
- E 85 Outer Mirror Switch Assembly
- E 86 Airbag Cut Off Switch Cylinder Sub-Assembly
- E 87 ID Code Box
- E 88 Lower No. 1 Instrument Panel Airbag Assembly
- E 90 Radio & Display Receiver Assembly
- E 91 Stereo Component Amplifier Assembly
- E 92 Stereo Component Amplifier Assembly
- E 94 Seat Heater Switch LH
- E 95 Windshield Wiper Relay Assembly
- E 96 Hazard Warning Signal Switch Assembly
- E 98 Clearance Warning ECU Assembly
- E 99 No. 1 Clearance Warning Buzzer
- E 115 Certification ECU
- E 116 Certification ECU
- E 117 Certification ECU
- E 125 Radio & Display Receiver Assembly
- E 129 No. 14 Junction Connector
- E 130 A/C Control Assembly
- E 139 Radio Receiver Assembly
- E 140 No. 15 Junction Connector

Position of Parts in Instrument Panel <LHD>

E33  
White

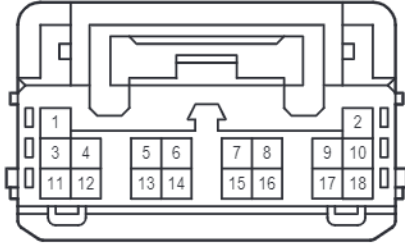

82824-52390

E34  
White

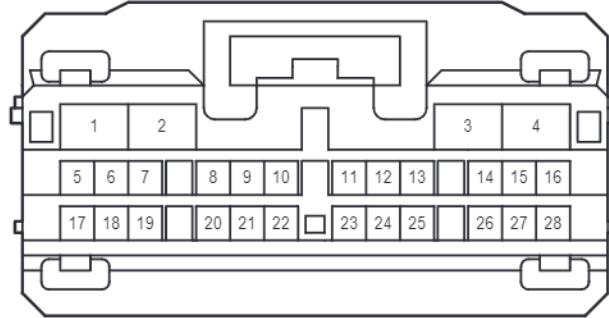

82824-52380

E35  
White

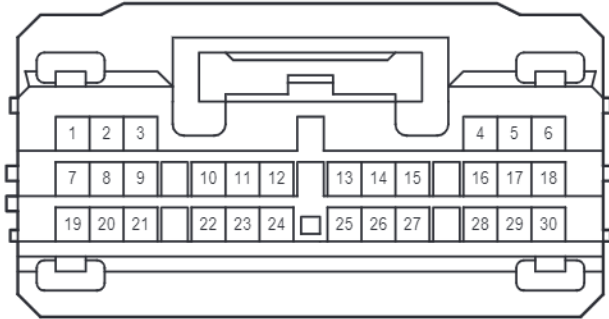

82824-52370

E50  
Gray

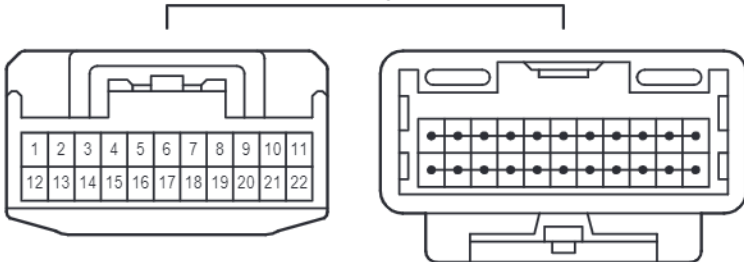

90980-12372

E51  
Gray



Position of Parts in Instrument Panel <LHD>

E52  
Gray

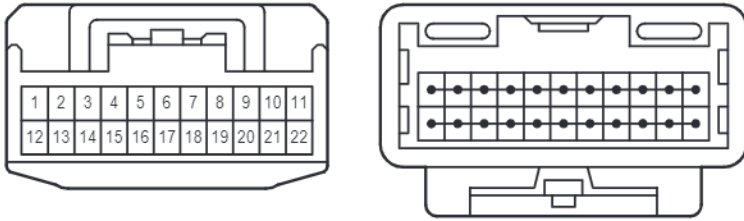

90980-12372

E53  
White

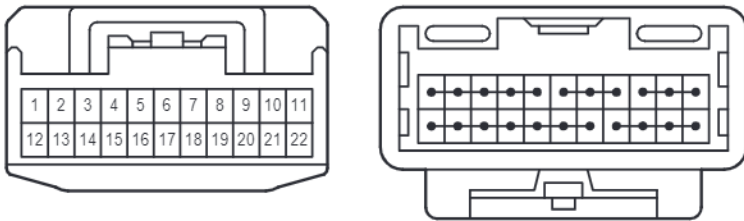

90980-12372

E54  
Black

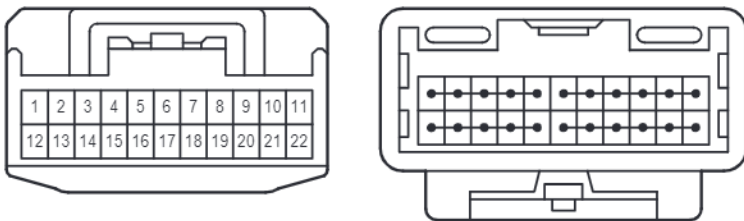

90980-12372

E55  
Black

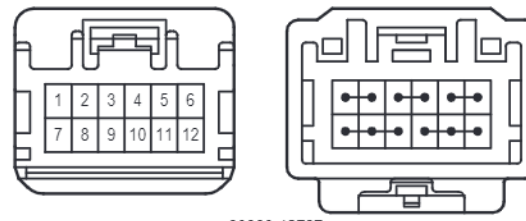

90980-12737

E56  
Black

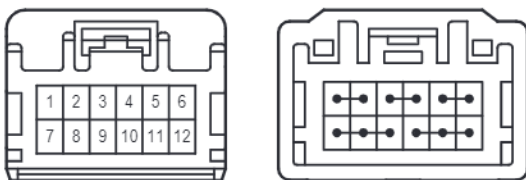

E60  
White

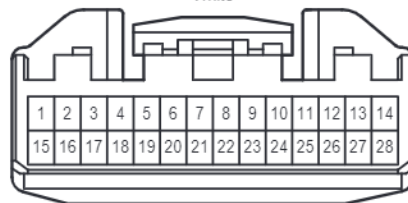

90980-12555

E71  
Black



90980-12551

Position of Parts in Instrument Panel <LHD>

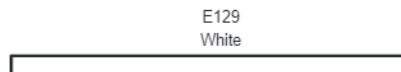
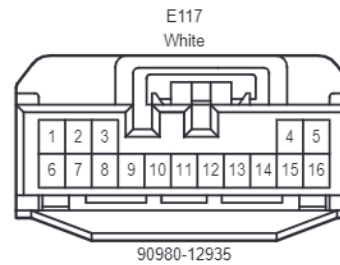
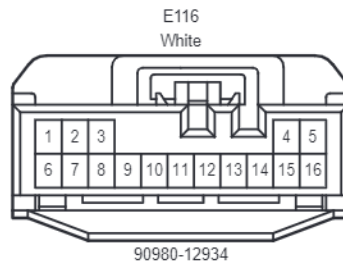
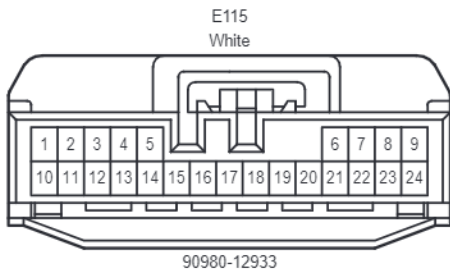
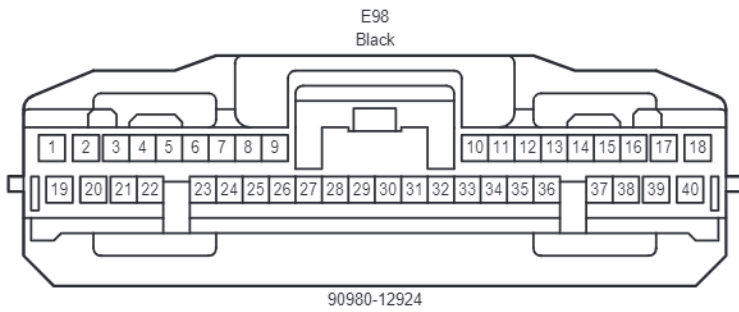
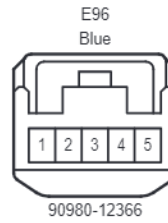
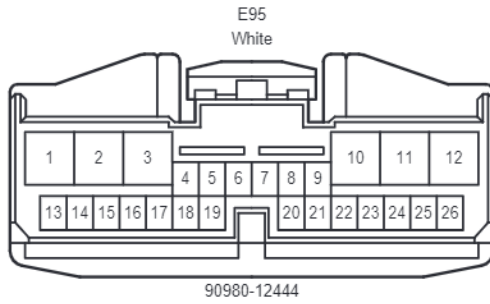
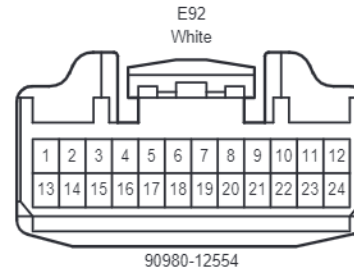
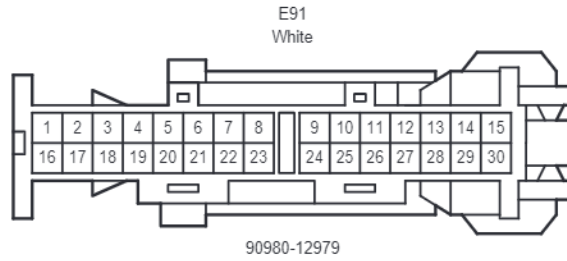

Position of Parts in Instrument Panel <LHD>

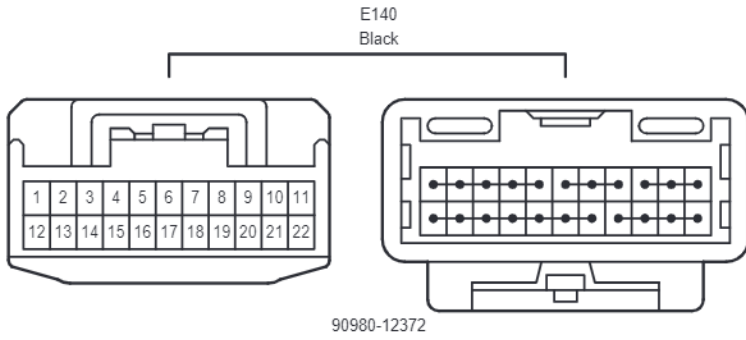
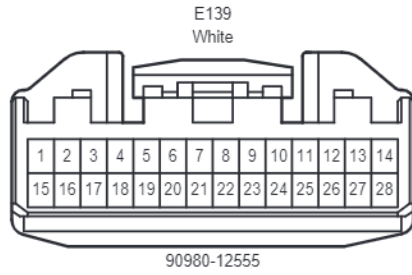

Position of Parts in Instrument Panel <LHD>

\*6 : Prior May 2015  
\*7 : May 2015 or later

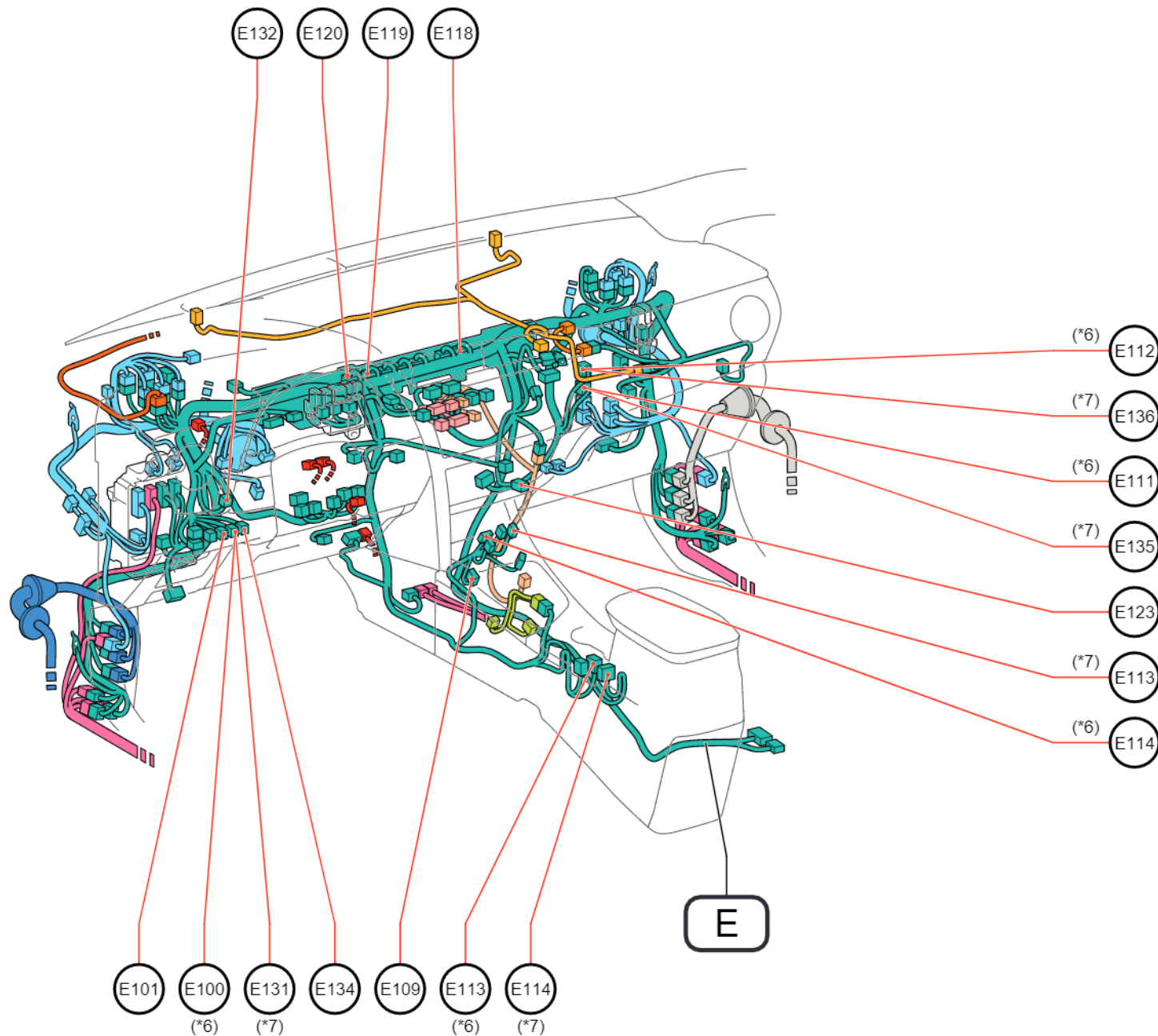

Position of Parts in Instrument Panel <LHD>

---

- E 100 Back Sonar or Clearance Sonar Switch Assembly
- E 101 Parking Assist Pre Support Switch Assembly
- E 109 Transmission Shift Main Switch
- E 111 Power Management Control ECU
- E 112 Power Management Control ECU
- E 113 Seat Heater Switch RH
- E 114 Combination Switch Assembly
- E 118 No. 2 CAN Junction Connector
- E 119 No. 3 CAN Junction Connector
- E 120 No. 1 CAN Junction Terminal
- E 123 No. 1 Tire Pressure Warning Switch
- E 131 Precrash System Cancel Switch Assembly
- E 132 Precrash Safety City Buzzer
- E 134 Parking Assist Pre Support Switch Assembly
- E 135 Hybrid Vehicle Control ECU Assembly
- E 136 Hybrid Vehicle Control ECU Assembly



Position of Parts in Instrument Panel <LHD>

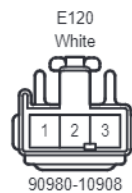
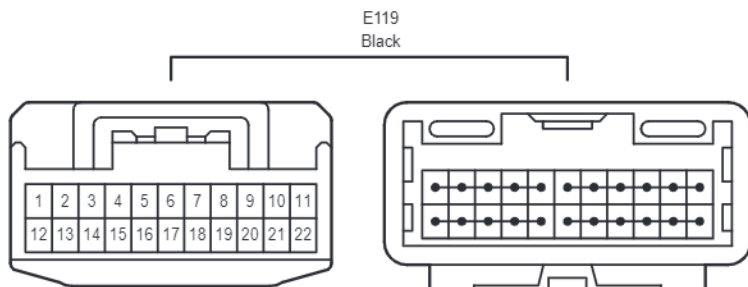
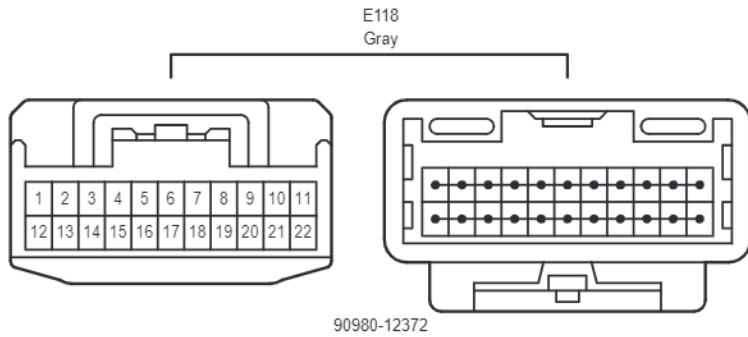
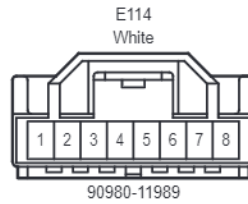
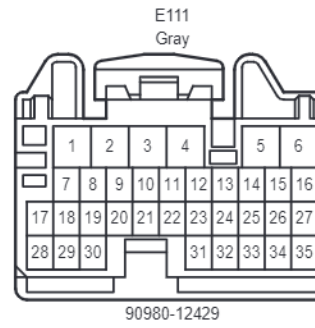
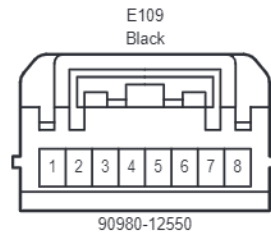
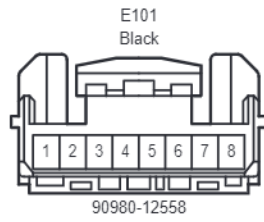

Position of Parts in Instrument Panel <LHD>

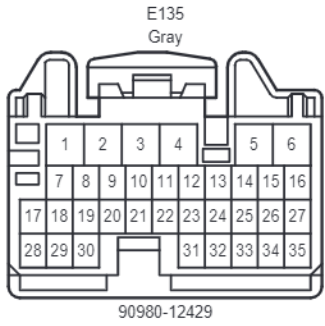

Position of Parts in Instrument Panel <LHD>

\*6 : Prior May 2015  
 \*7 : May 2015 or later

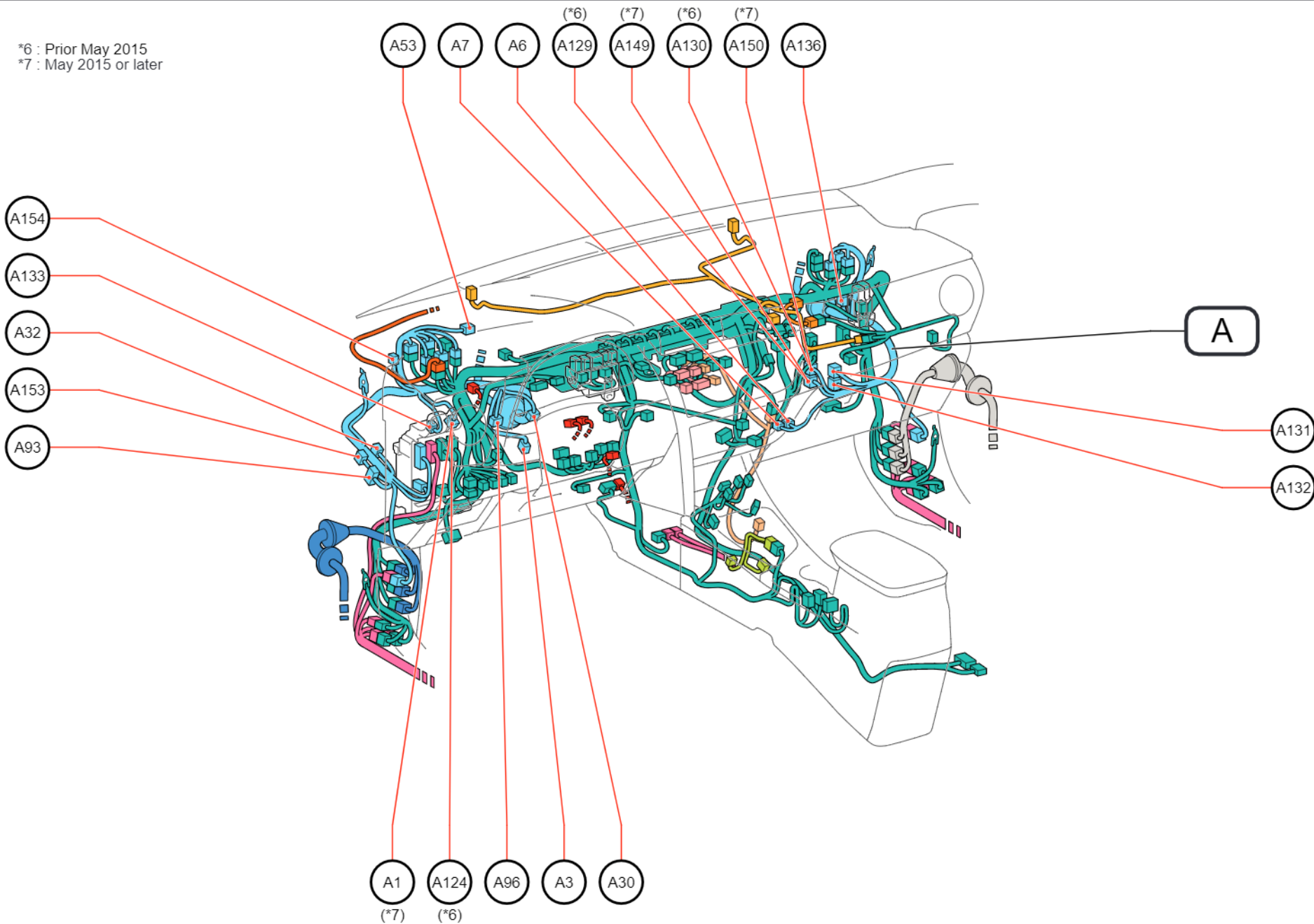

Position of Parts in Instrument Panel <LHD>

---

- A 1 Stop Light Switch Assembly
- A 3 Accelerator Pedal Sensor Assembly
- A 6 Quick Heater Assembly
- A 7 Quick Heater Assembly
- A 30 No. 1 Junction Connector
- A 32 No. 1 CAN Junction Connector
- A 53 Power Steering ECU Assembly
- A 93 Headlight Swivel ECU Assembly
- A 96 No. 2 Junction Connector
- A 124 Stop Light Switch Assembly
- A 129 Power Management Control ECU
- A 130 Power Management Control ECU
- A 131 Transmission Control ECU Assembly
- A 132 Transmission Control ECU Assembly
- A 133 Brake Pedal Stroke Sensor Assembly
- A 136 No. 9 Junction Connector
- A 149 Hybrid Vehicle Control ECU Assembly
- A 150 Hybrid Vehicle Control ECU Assembly
- A 153 Diode(TSS\_C\_RP)
- A 154 Diode(TSS\_C\_FW)

Position of Parts in Instrument Panel <LHD>

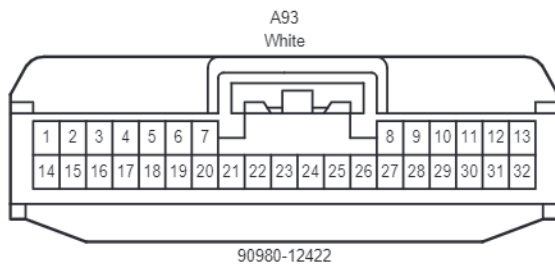
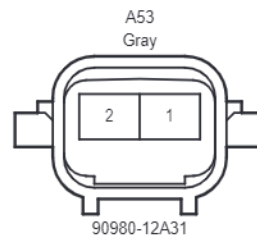
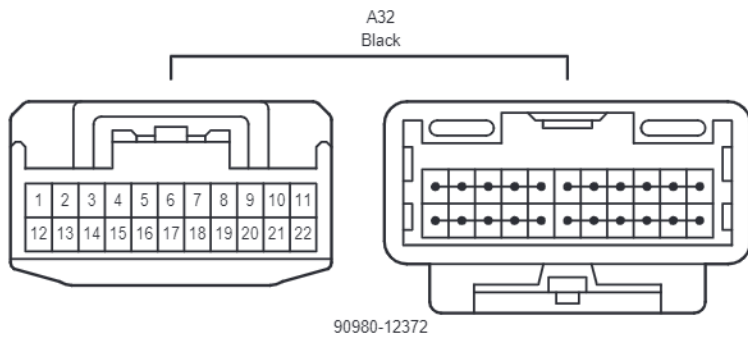
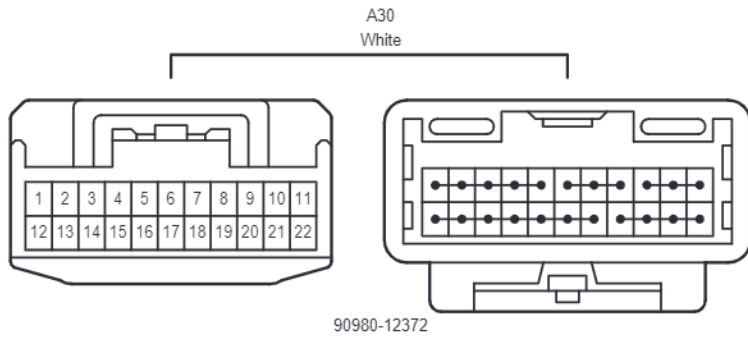
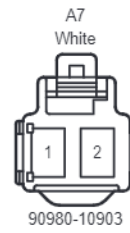
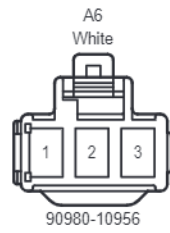
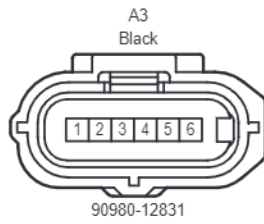

A96  
Blue

A124  
Black

Position of Parts in Instrument Panel <LHD>

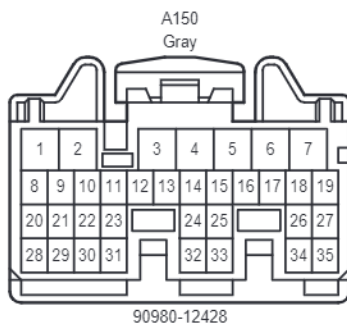
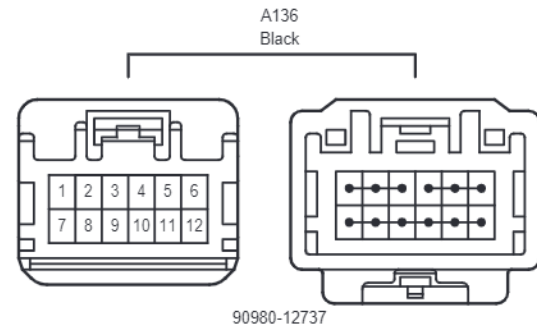
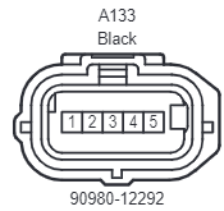
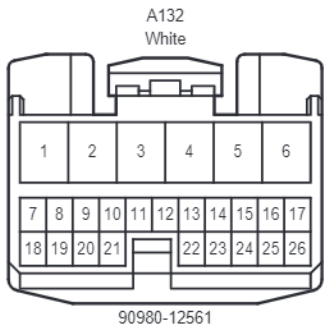
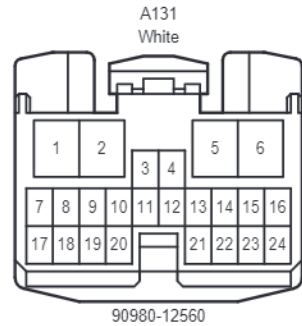
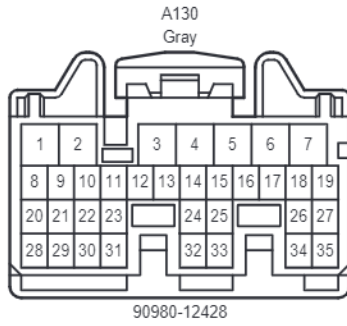

Position of Parts in Instrument Panel <LHD>

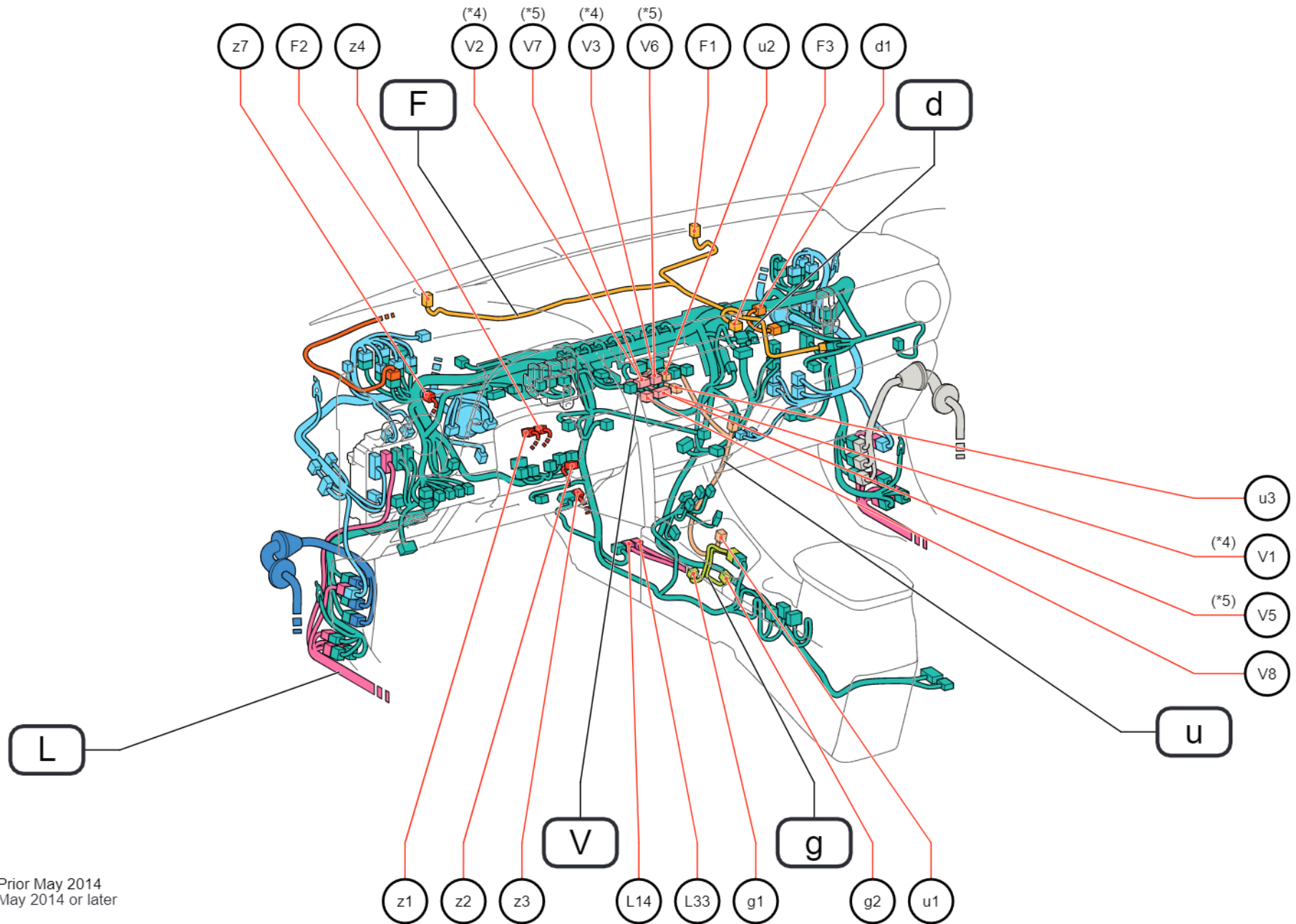

\*4 : Prior May 2014  
 \*5 : May 2014 or later

Position of Parts in Instrument Panel <LHD>

---

- F 1 Cooler Thermistor (Solar Sensor)
- F 2 Automatic Light Control Sensor
- F 3 Clock Assembly
  
- L 14 Airbag Sensor Assembly
- L 33 Airbag Sensor Assembly
  
- V 1 Extension Module
- V 2 Radio & Display Receiver Assembly
- V 3 Radio & Display Receiver Assembly
- V 5 Extension Module
- V 6 Radio & Display Receiver Assembly
- V 7 Radio & Display Receiver Assembly
- V 8 Extension Module
  
- d 1 Instrument Panel Passenger Airbag Assembly
  
- g 1 No. 1 Shift Lever Position Sensor
- g 2 No. 2 Shift Lever Position Sensor
  
- u 1 No. 1 Stereo Jack Adapter Assembly
- u 2 Radio & Display Receiver Assembly
- u 3 Extension Module
  
- z 1 Steering Pad Switch Assembly , Spiral Cable Sub-Assembly
- z 2 Driver Side Squib Assembly (Horn Button Assembly) , Spiral Cable Sub-Assembly
- z 3 A/C Blower Assembly (A/C Harness Assembly) , A/C Amplifier Assembly
- z 4 Cruise Control Main Switch , Spiral Cable Sub-Assembly
- z 7 Power Steering ECU Assembly,Power Steering Torque Sensor



Position of Parts in Instrument Panel <LHD>

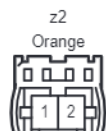
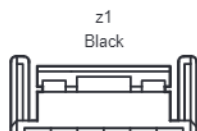
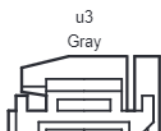
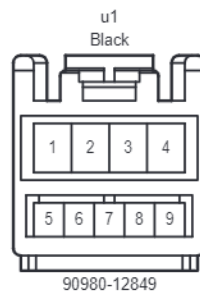
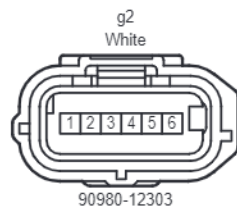
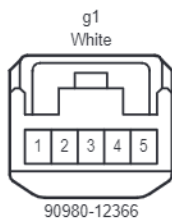
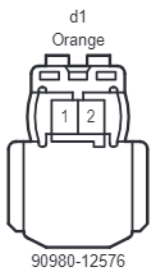
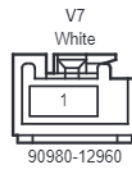
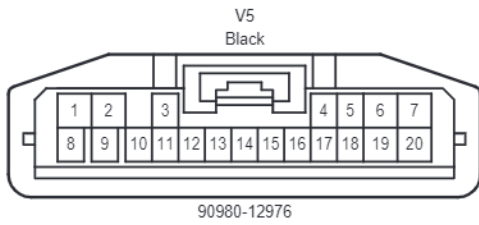
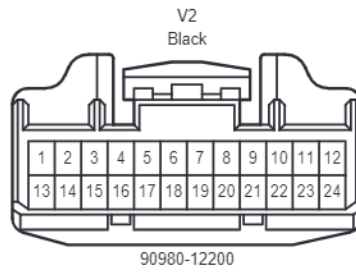
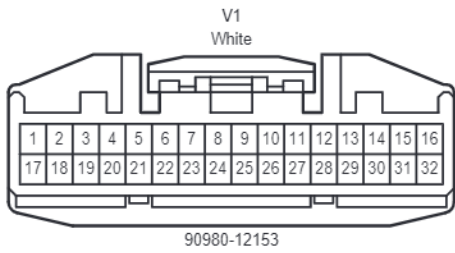
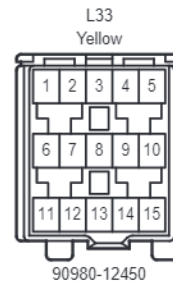
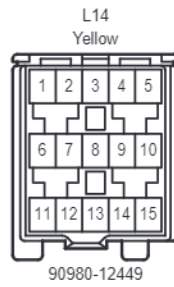
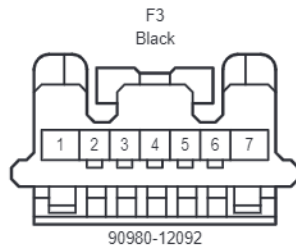
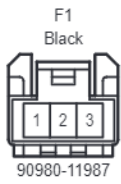



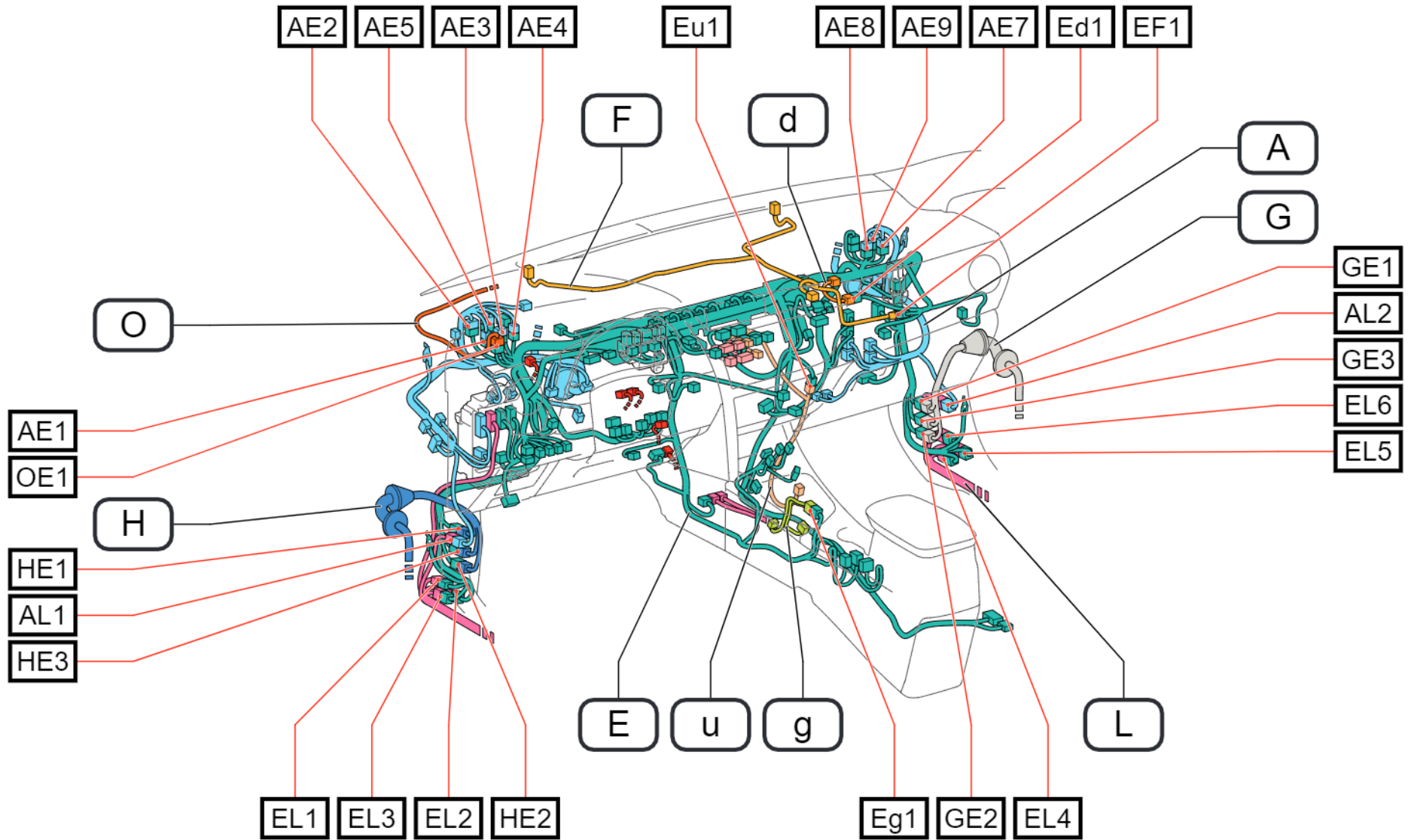

Wire and Wire in Instrument Panel <LHD>

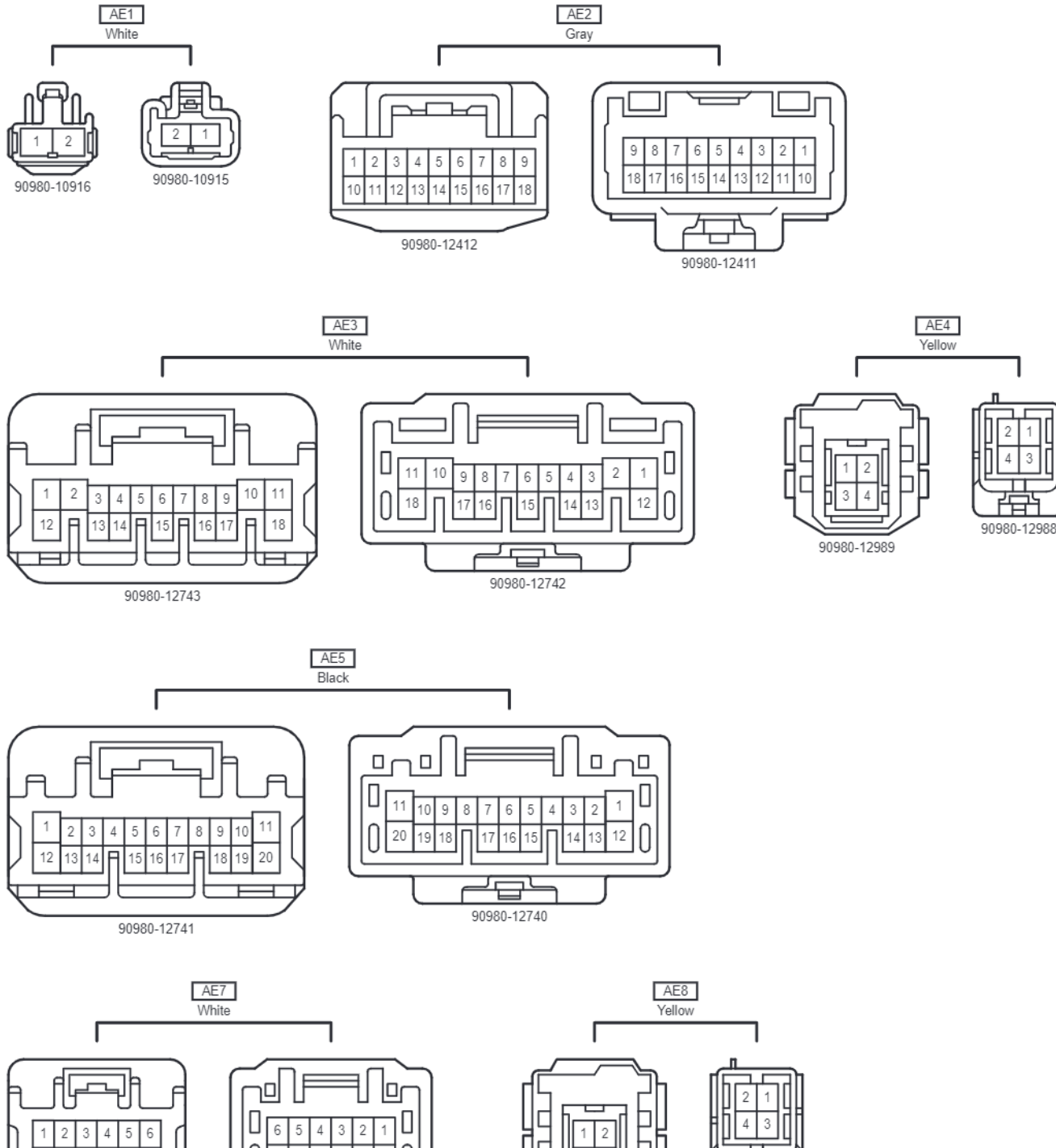

Wire and Wire in Instrument Panel <LHD>

AE9  
Gray

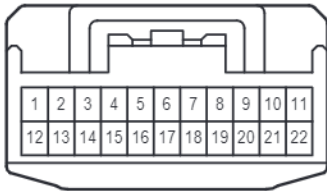

90980-12372

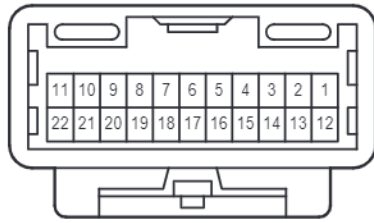

90980-12371

AL1  
White

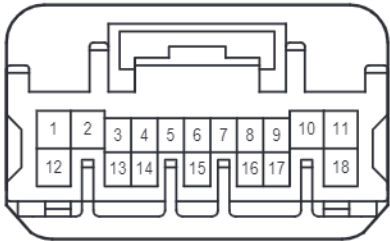

90980-12743

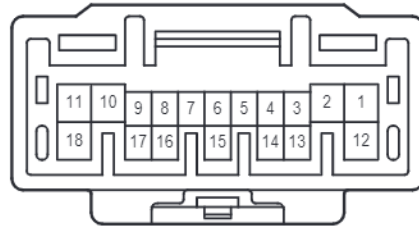

90980-12742

AL2  
White

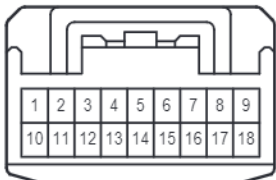

90980-12412

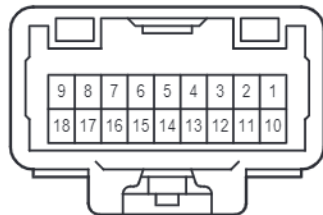

90980-12411

EF1  
White



90980-12368



90980-12367

EL1  
White

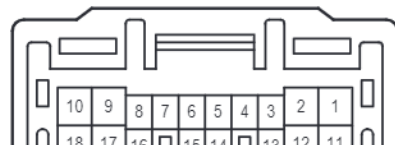
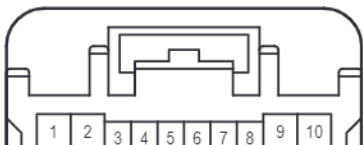

Wire and Wire in Instrument Panel <LHD>

EL2  
Black

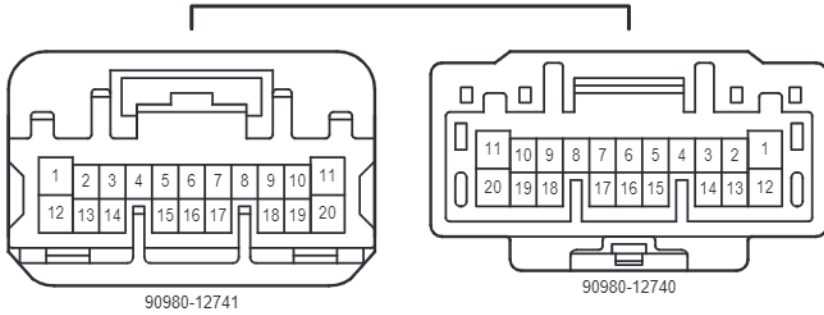

EL3  
Gray

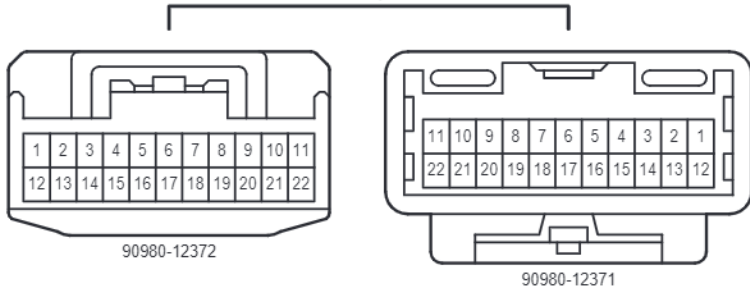

EL4  
Black

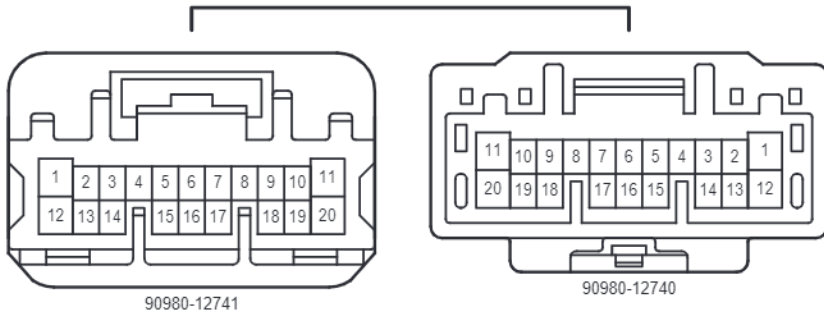

EL5  
Gray



EL6  
White

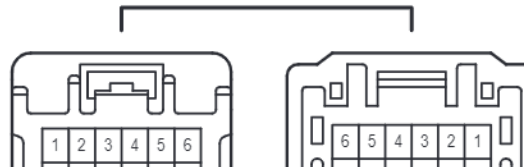

Wire and Wire in Instrument Panel <LHD>

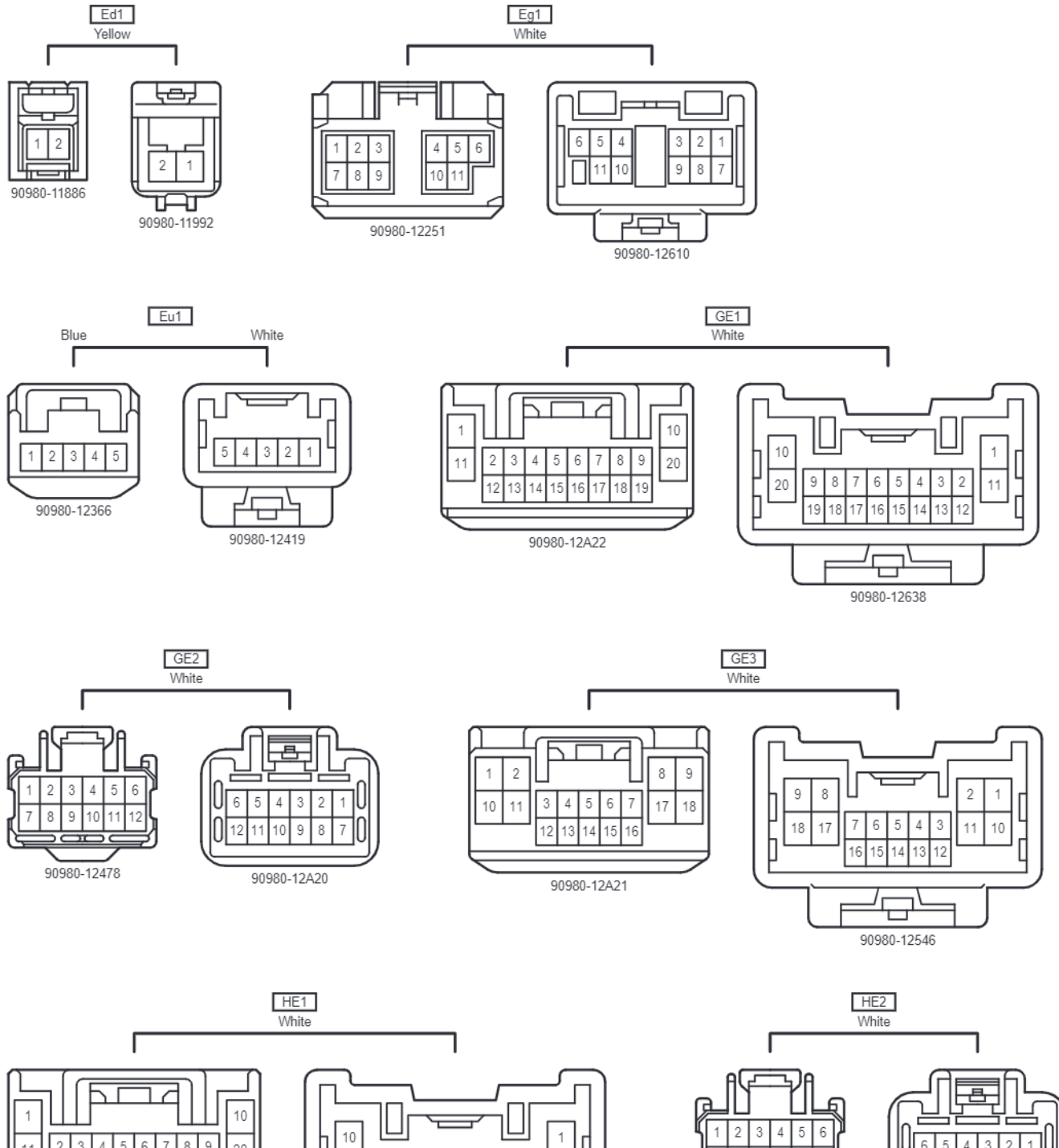

Wire and Wire in Instrument Panel <LHD>

HE3  
White

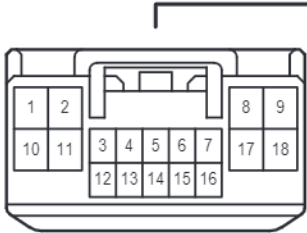

90980-12A21

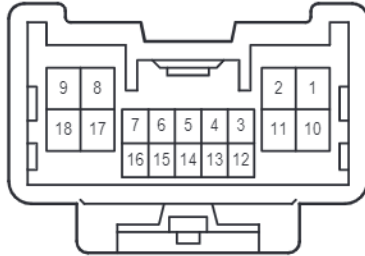

90980-12546

OE1  
White

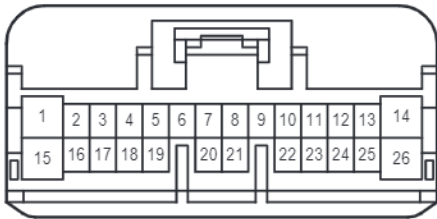

90980-12771

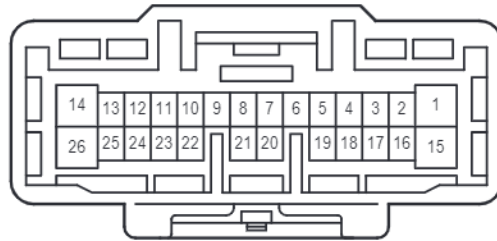

90980-12770



Ground Points in Instrument Panel <RHD>

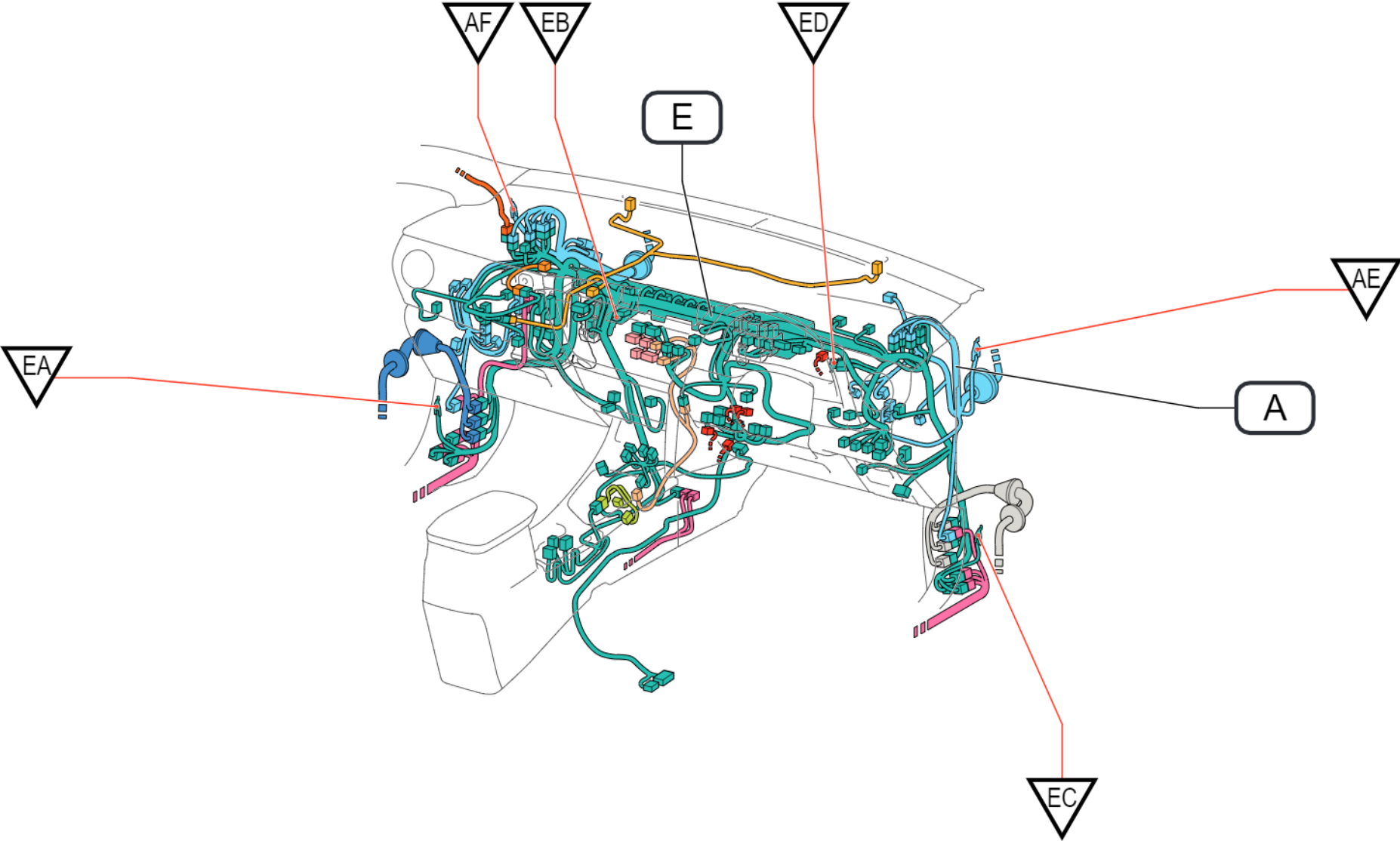

Position of Parts in Instrument Panel <RHD>

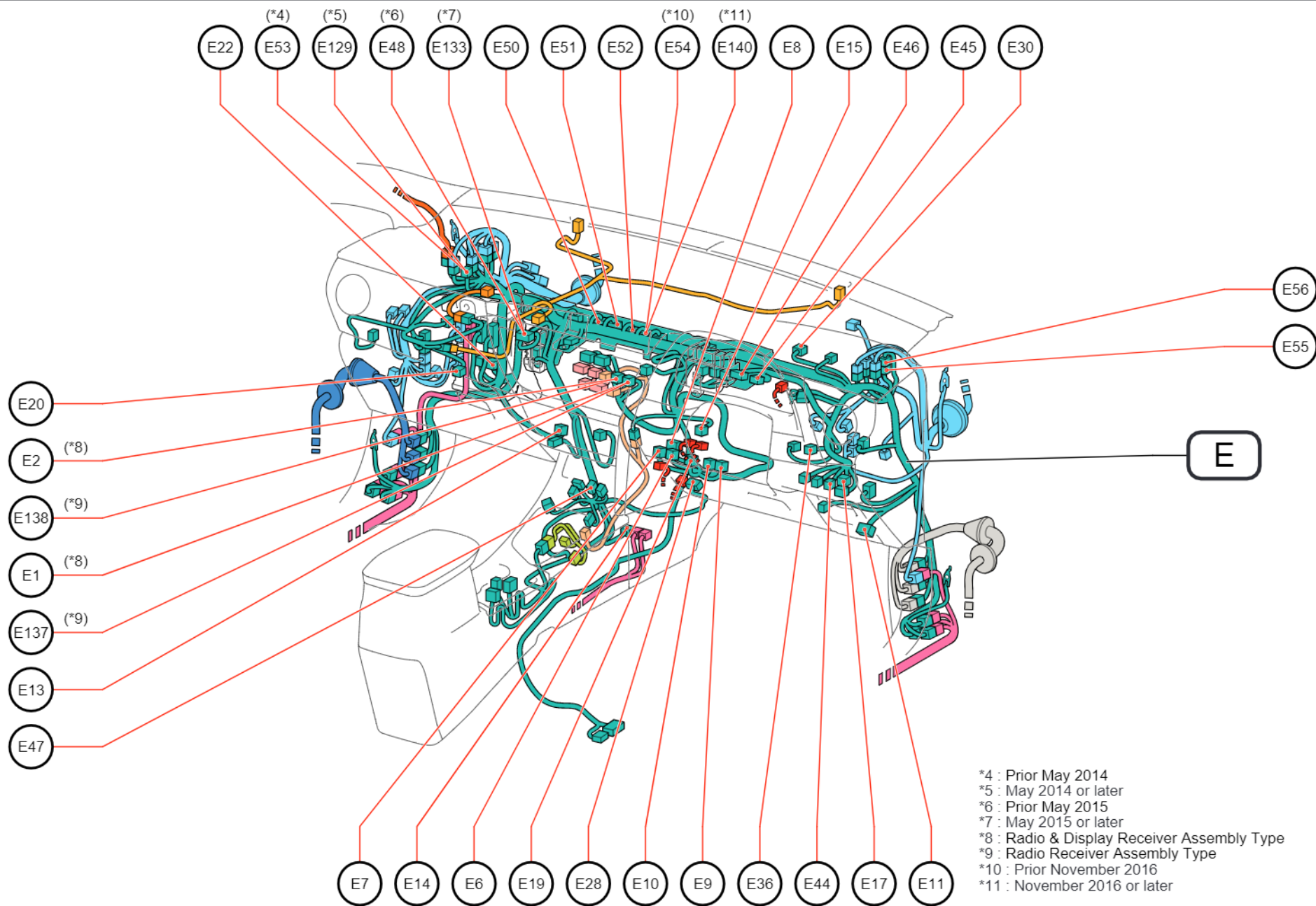

\*4 : Prior May 2014  
 \*5 : May 2014 or later  
 \*6 : Prior May 2015  
 \*7 : May 2015 or later  
 \*8 : Radio & Display Receiver Assembly Type  
 \*9 : Radio Receiver Assembly Type  
 \*10 : Prior November 2016  
 \*11 : November 2016 or later

Position of Parts in Instrument Panel <RHD>

---

- E 1 Radio & Display Receiver Assembly
- E 2 Radio & Display Receiver Assembly
- E 6 Spiral Cable Sub-Assembly
- E 7 Spiral Cable Sub-Assembly
- E 8 Headlight Dimmer Switch Assembly
- E 9 Windshield Wiper Switch Assembly
- E 10 Windshield Wiper Switch Assembly
- E 11 DLC3
- E 13 Blower Motor with Fan Sub-Assembly
- E 14 Airbag Sensor Assembly
- E 15 Cooler Thermistor (Room Temperature Sensor)
- E 17 Outer Mirror Switch Assembly
- E 19 Steering Sensor (Spiral Cable with Sensor Sub-Assembly)
- E 20 Glove Box Light Assembly
- E 22 Main Body ECU
- E 28 A/C Amplifier Assembly
- E 30 Power Steering ECU Assembly
- E 36 Power Switch
- E 44 Headlight Leveling Switch
- E 45 Combination Meter Assembly
- E 46 Combination Meter Assembly
- E 47 VSC Off Switch
- E 48 Telltale Light Assembly
- E 50 No. 3 Junction Connector
- E 51 No. 4 Junction Connector
- E 52 No. 5 Junction Connector
- E 53 No. 6 Junction Connector
- E 54 No. 7 Junction Connector
- E 55 No. 8 Junction Connector
- E 56 No. 8 Junction Connector
- E 129 No. 14 Junction Connector
- E 133 Clock Assembly
- E 137 Radio Receiver Assembly
- E 138 Radio Receiver Assembly
- E 140 No. 15 Junction Connector

Position of Parts in Instrument Panel <RHD>

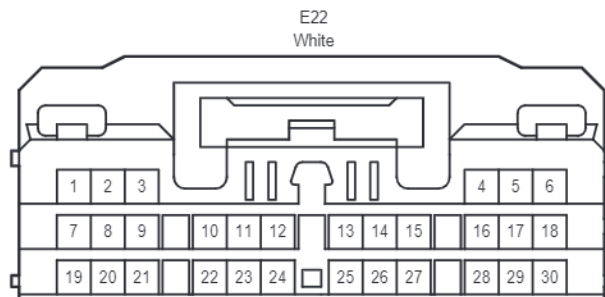
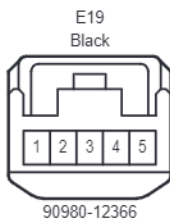
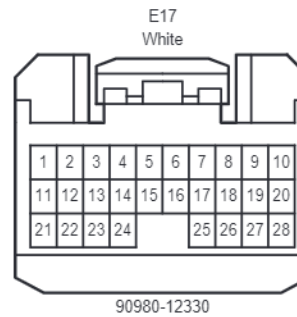
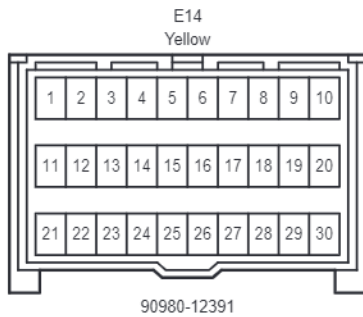
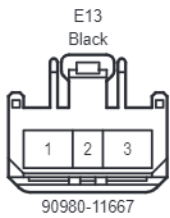
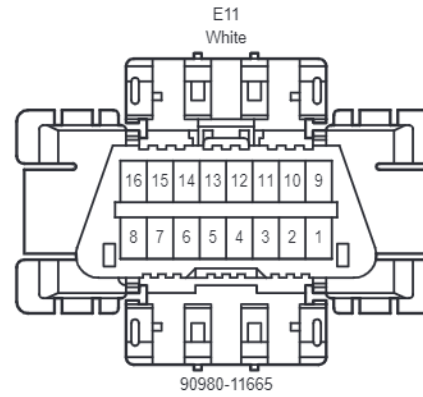
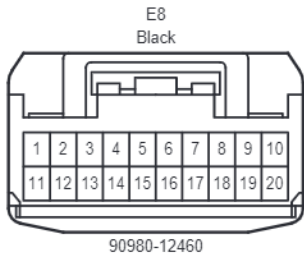
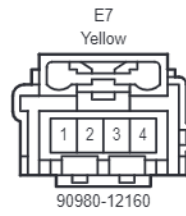
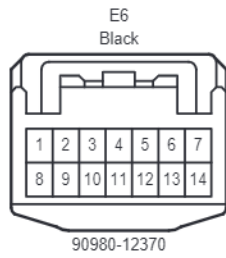

Position of Parts in Instrument Panel <RHD>

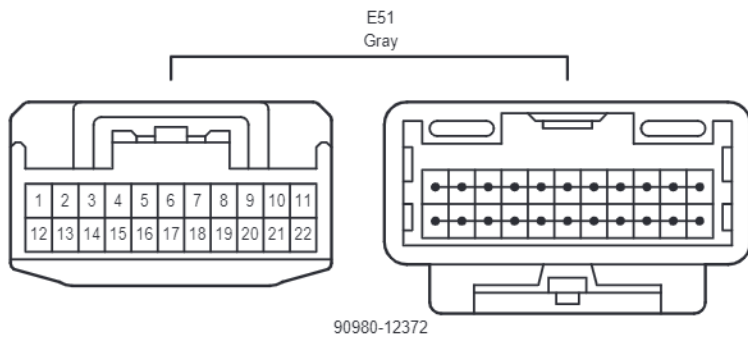
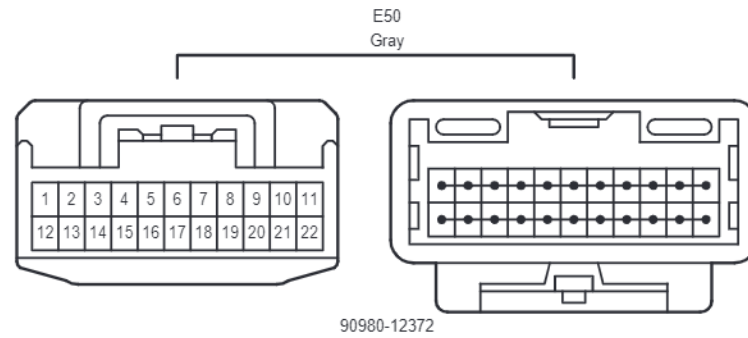
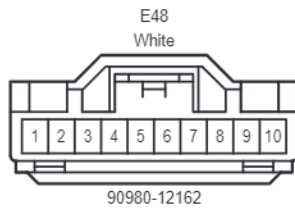
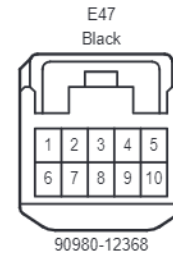
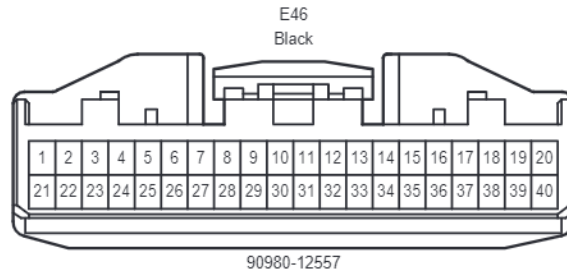
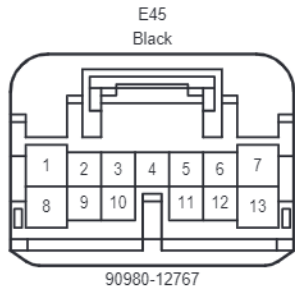
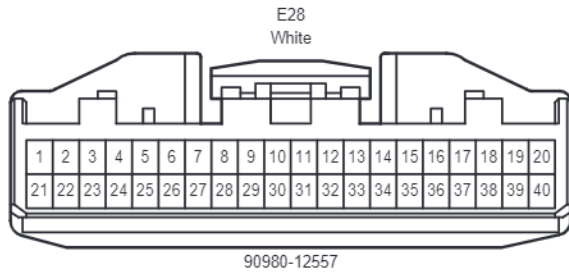

Position of Parts in Instrument Panel <RHD>

E53  
White

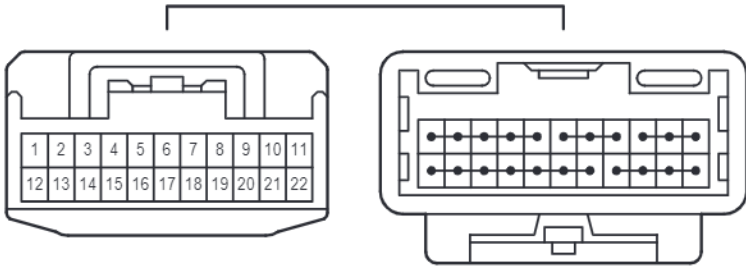

90980-12372

E54  
Black

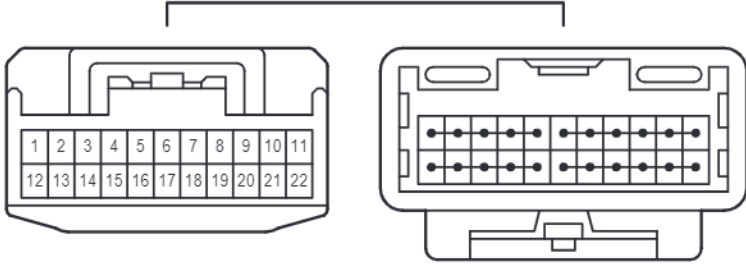

90980-12372

E55  
Black

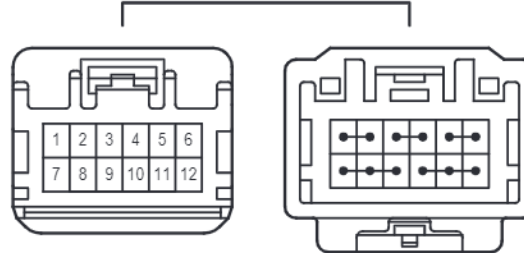

90980-12737

E56  
Black

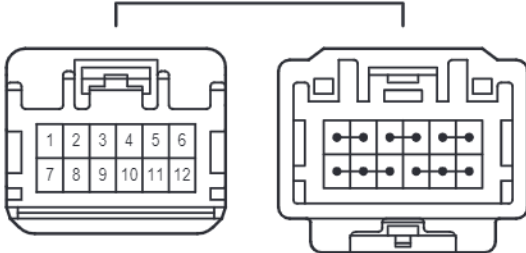

90980-12737

E129  
White

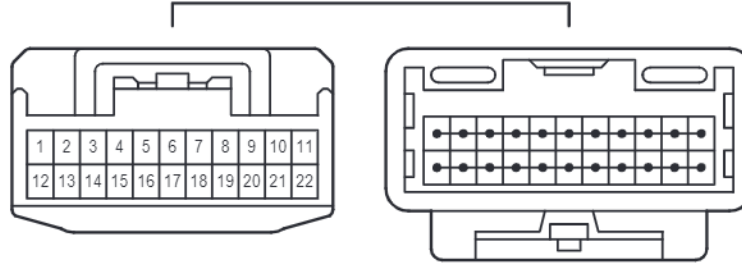

90980-12372

E133  
Black



90980-12553

E137  
White

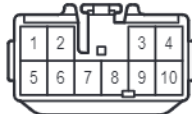

90980-10997

E138  
White



90980-10996

Position of Parts in Instrument Panel <RHD>

\*1 : Refer to the Service Bulletin  
for the installation position of the parts.

\*4 : Prior May 2014

\*5 : May 2014 or later

\*6 : Prior May 2015

\*7 : May 2015 or later

\*8 : Radio & Display Receiver Assembly Type

\*9 : Radio Receiver Assembly Type

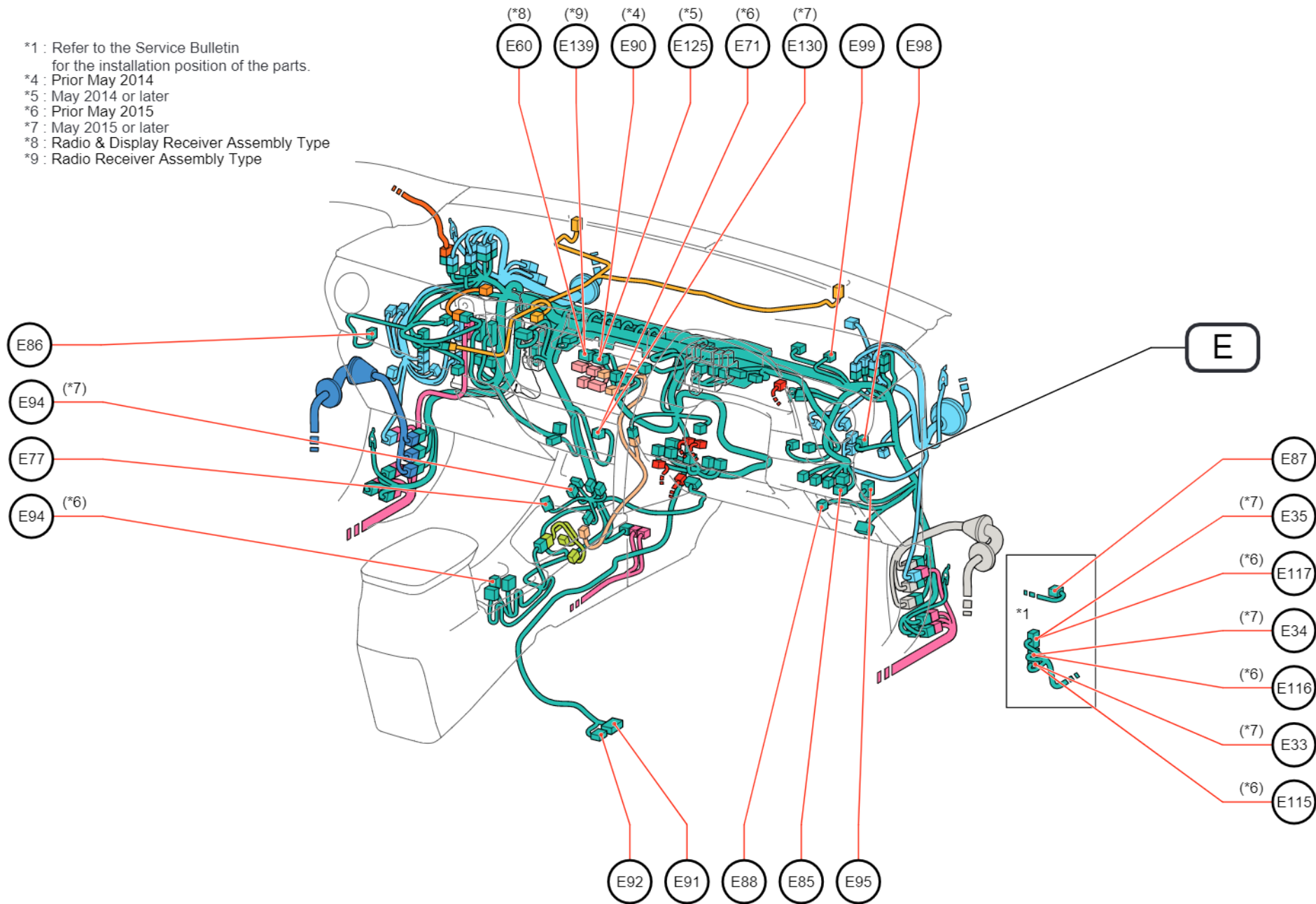

Position of Parts in Instrument Panel <RHD>

---

- E 33 Certification ECU
- E 34 Certification ECU
- E 35 Certification ECU
- E 60 Radio & Display Receiver Assembly
- E 71 A/C Control Assembly
- E 77 No. 1 Power Outlet Socket Assembly
- E 85 Outer Mirror Switch Assembly
- E 86 Airbag Cut Off Switch Cylinder Sub-Assembly
- E 87 ID Code Box
- E 88 Lower No. 1 Instrument Panel Airbag Assembly
- E 90 Radio & Display Receiver Assembly
- E 91 Stereo Component Amplifier Assembly
- E 92 Stereo Component Amplifier Assembly
- E 94 Seat Heater Switch LH
- E 95 Windshield Wiper Relay Assembly
- E 98 Clearance Warning ECU Assembly
- E 99 No. 1 Clearance Warning Buzzer
- E 115 Certification ECU
- E 116 Certification ECU
- E 117 Certification ECU
- E 125 Radio & Display Receiver Assembly
- E 130 A/C Control Assembly
- E 139 Radio Receiver Assembly



Position of Parts in Instrument Panel <RHD>

E33  
White

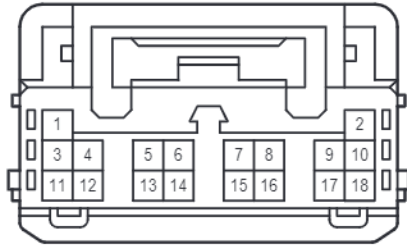

82824-52390

E34  
White

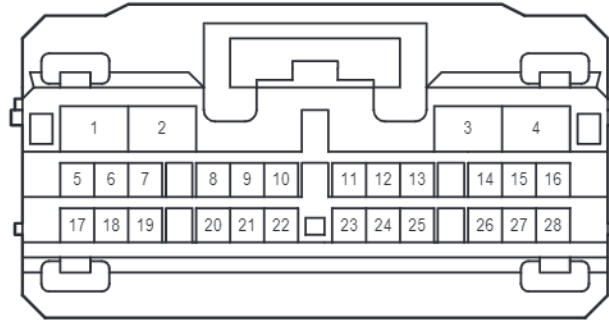

82824-52380

E35  
White

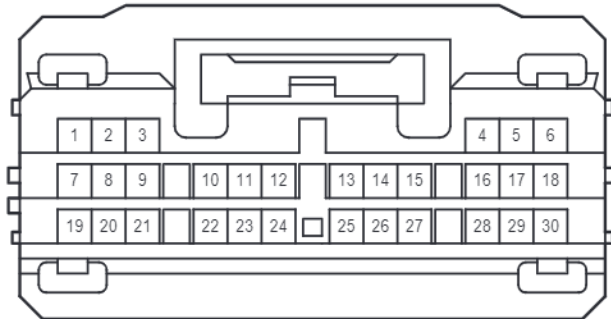

82824-52370

E60  
White

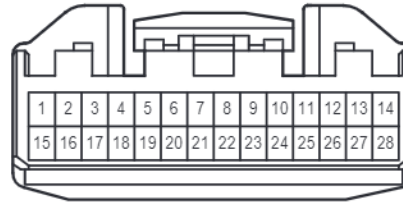

90980-12555

E71  
Black



90980-12551

E77  
Black



90080-98182

E85  
Black

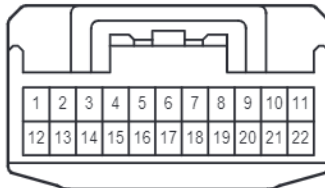

90980-12372

E86  
White



90980-12063

E87  
White

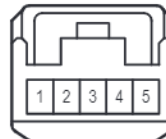

90980-12366

E88  
Yellow

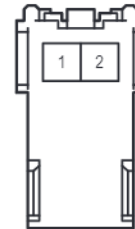

90980-12253

E90  
White



E91  
White

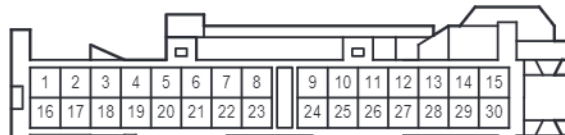

E92  
White

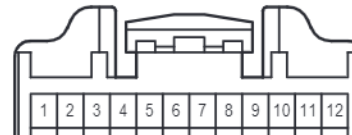

cardiagn.com

Position of Parts in Instrument Panel <RHD>

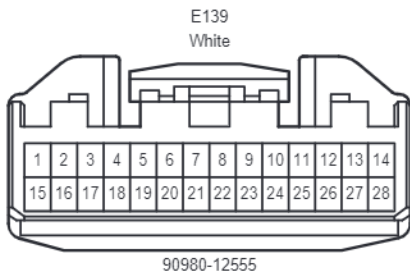
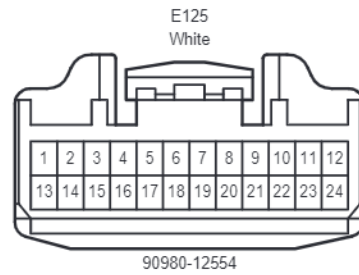
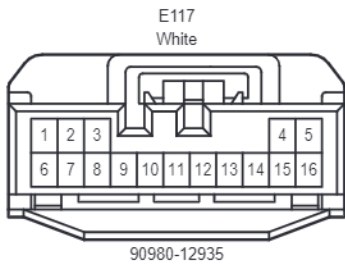
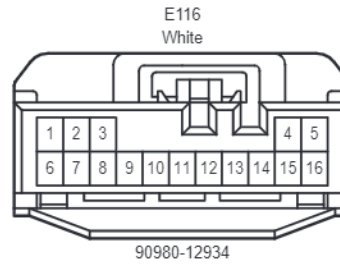
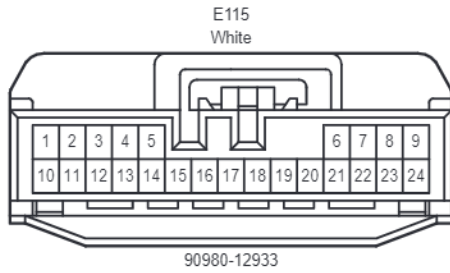
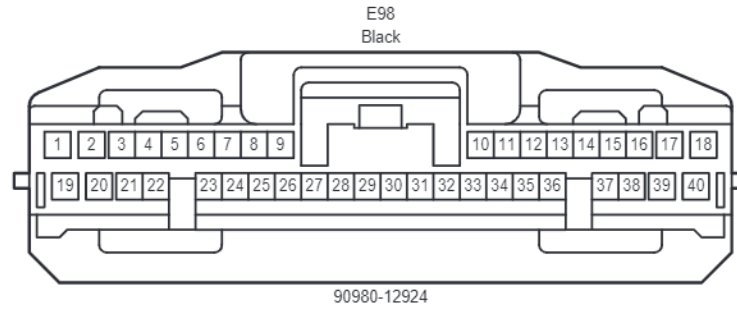
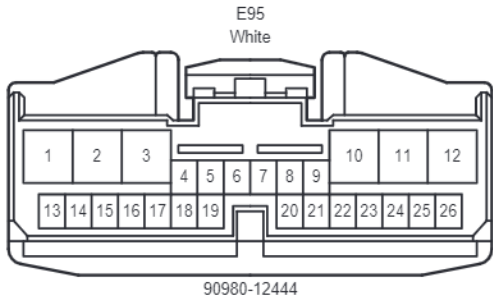

Position of Parts in Instrument Panel <RHD>

\*6 : Prior May 2015  
\*7 : May 2015 or later

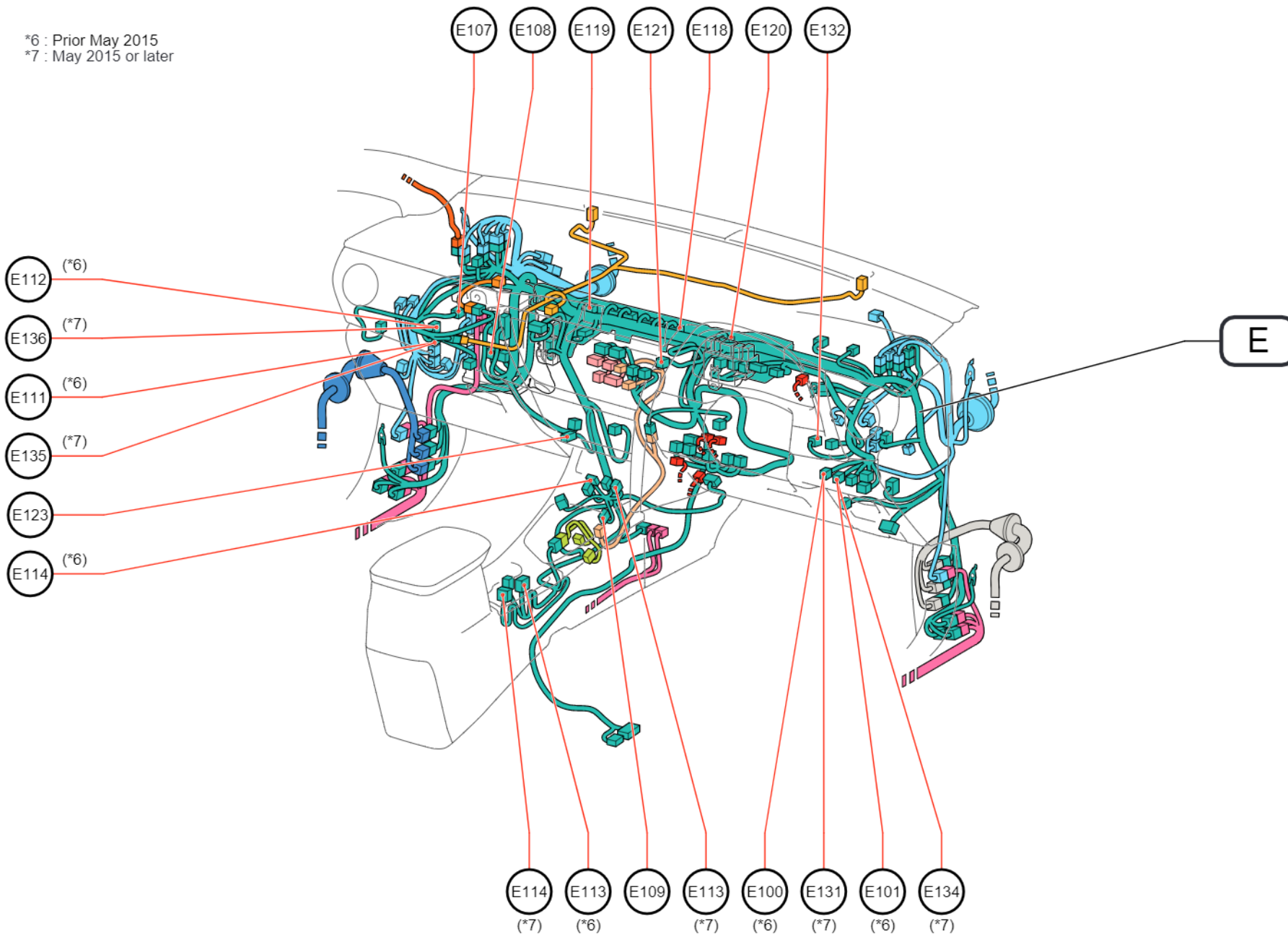

Position of Parts in Instrument Panel <RHD>

---

- E 100 Back Sonar or Clearance Sonar Switch Assembly
- E 101 Parking Assist Pre Support Switch Assembly
- E 107 Double Lock Door Control Relay Assembly
- E 108 Main Body ECU
- E 109 Transmission Shift Main Switch
- E 111 Power Management Control ECU
- E 112 Power Management Control ECU
- E 113 Seat Heater Switch RH
- E 114 Combination Switch Assembly
- E 118 No. 2 CAN Junction Connector
- E 119 No. 3 CAN Junction Connector
- E 120 No. 1 CAN Junction Terminal
- E 121 Hazard Warning Signal Switch Assembly
- E 123 No. 1 Tire Pressure Warning Switch
- E 131 Precrash System Cancel Switch Assembly
- E 132 Precrash Safety City Buzzer
- E 134 Parking Assist Pre Support Switch Assembly
- E 135 Hybrid Vehicle Control ECU Assembly
- E 136 Hybrid Vehicle Control ECU Assembly

Position of Parts in Instrument Panel <RHD>

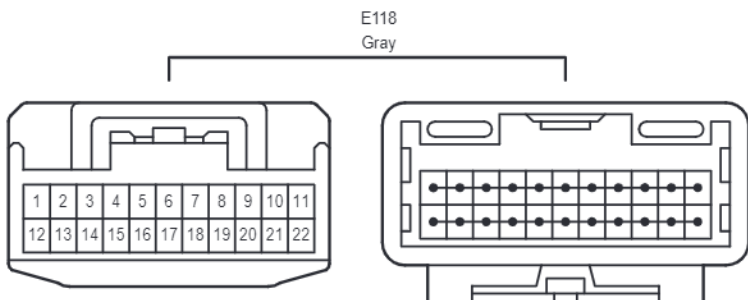
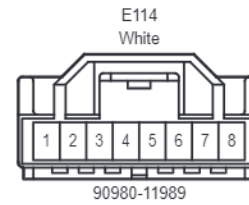
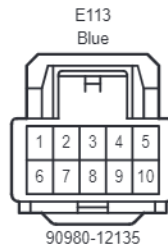
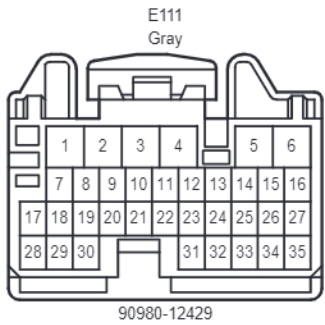
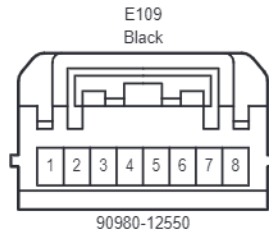
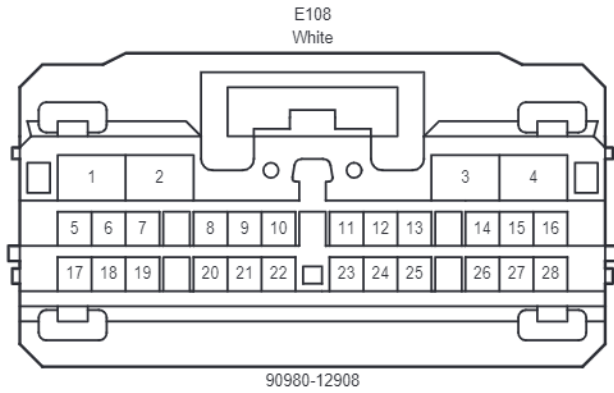
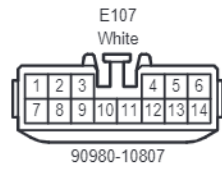
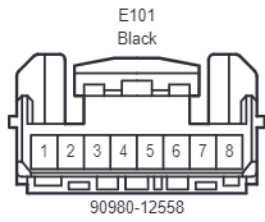

Position of Parts in Instrument Panel <RHD>

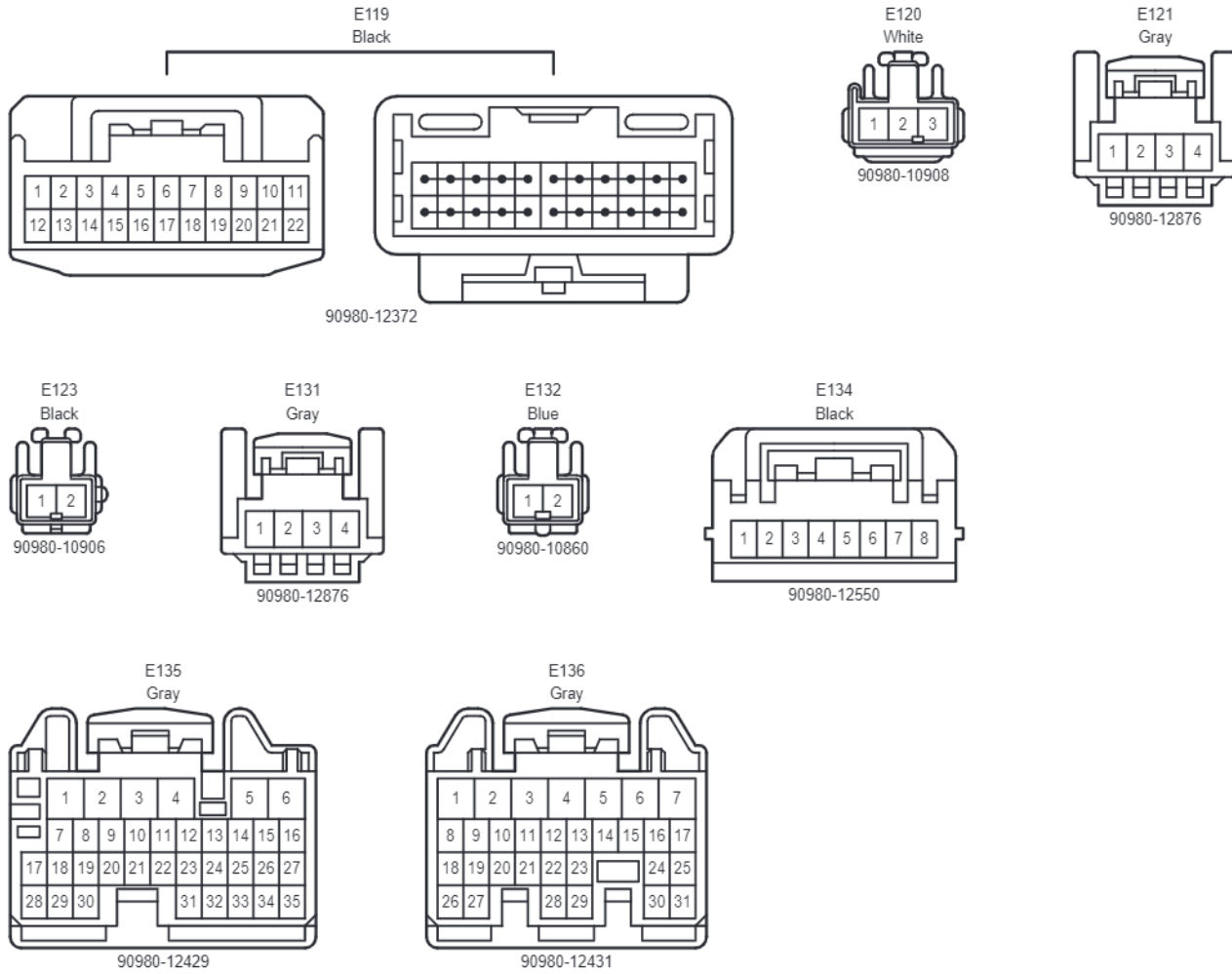

Position of Parts in Instrument Panel <RHD>

\*6 : Prior May 2015  
\*7 : May 2015 or later

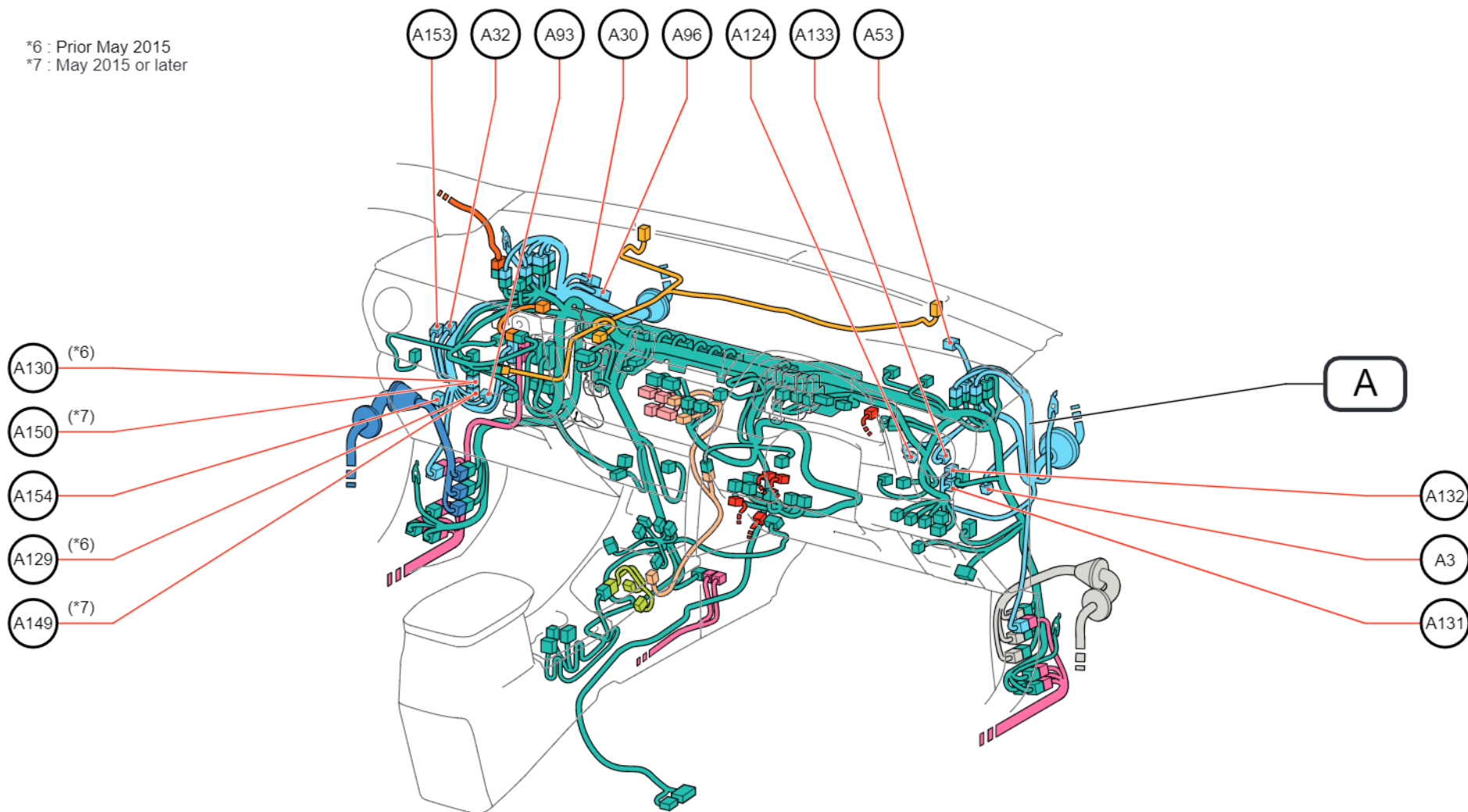

Position of Parts in Instrument Panel <RHD>

---

- A 3 Accelerator Pedal Sensor Assembly
- A 30 No. 1 Junction Connector
- A 32 No. 1 CAN Junction Connector
- A 53 Power Steering ECU Assembly
- A 93 Headlight Swivel ECU Assembly
- A 96 No. 2 Junction Connector
- A 124 Stop Light Switch Assembly
- A 129 Power Management Control ECU
- A 130 Power Management Control ECU
- A 131 Transmission Control ECU Assembly
- A 132 Transmission Control ECU Assembly
- A 133 Brake Pedal Stroke Sensor Assembly
- A 149 Hybrid Vehicle Control ECU Assembly
- A 150 Hybrid Vehicle Control ECU Assembly
- A 153 Diode(TSS\_C\_RP)
- A 154 Diode(TSS\_C\_FW)



Position of Parts in Instrument Panel <RHD>

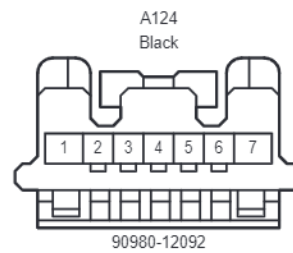
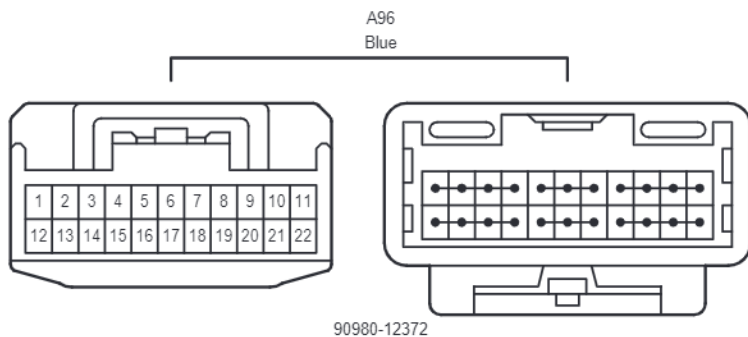
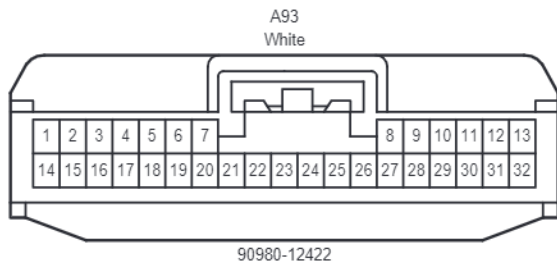
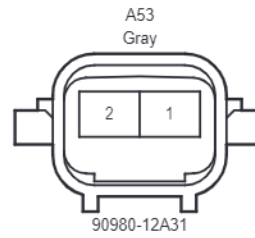
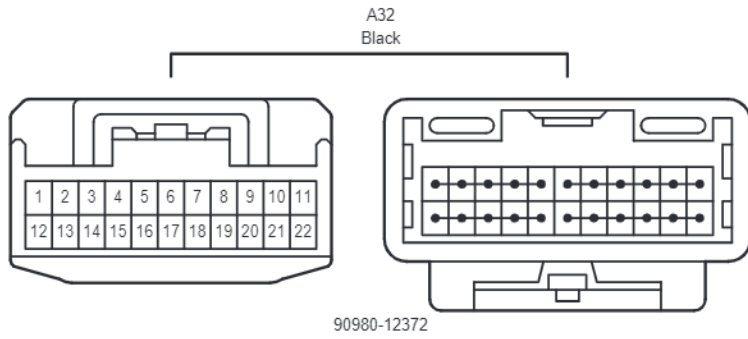
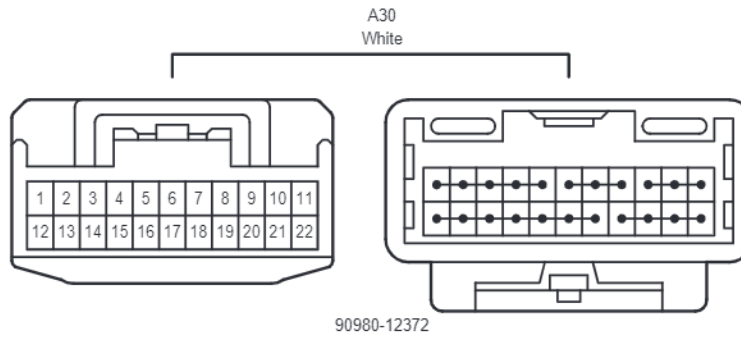
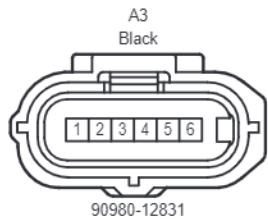

Position of Parts in Instrument Panel <RHD>

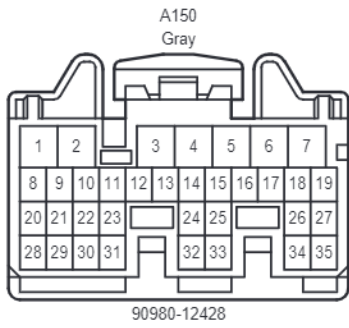
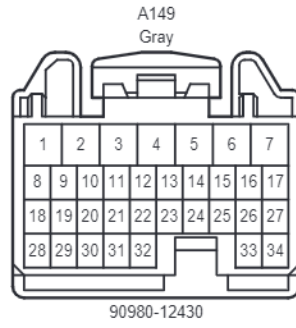
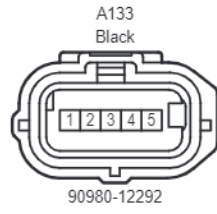
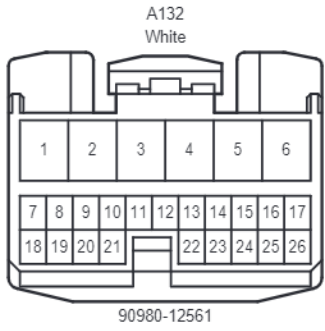

Position of Parts in Instrument Panel <RHD>

\*2 : Dual Mode Type  
 \*3 : Single Mode Type  
 \*4 : Prior May 2014  
 \*5 : May 2014 or later

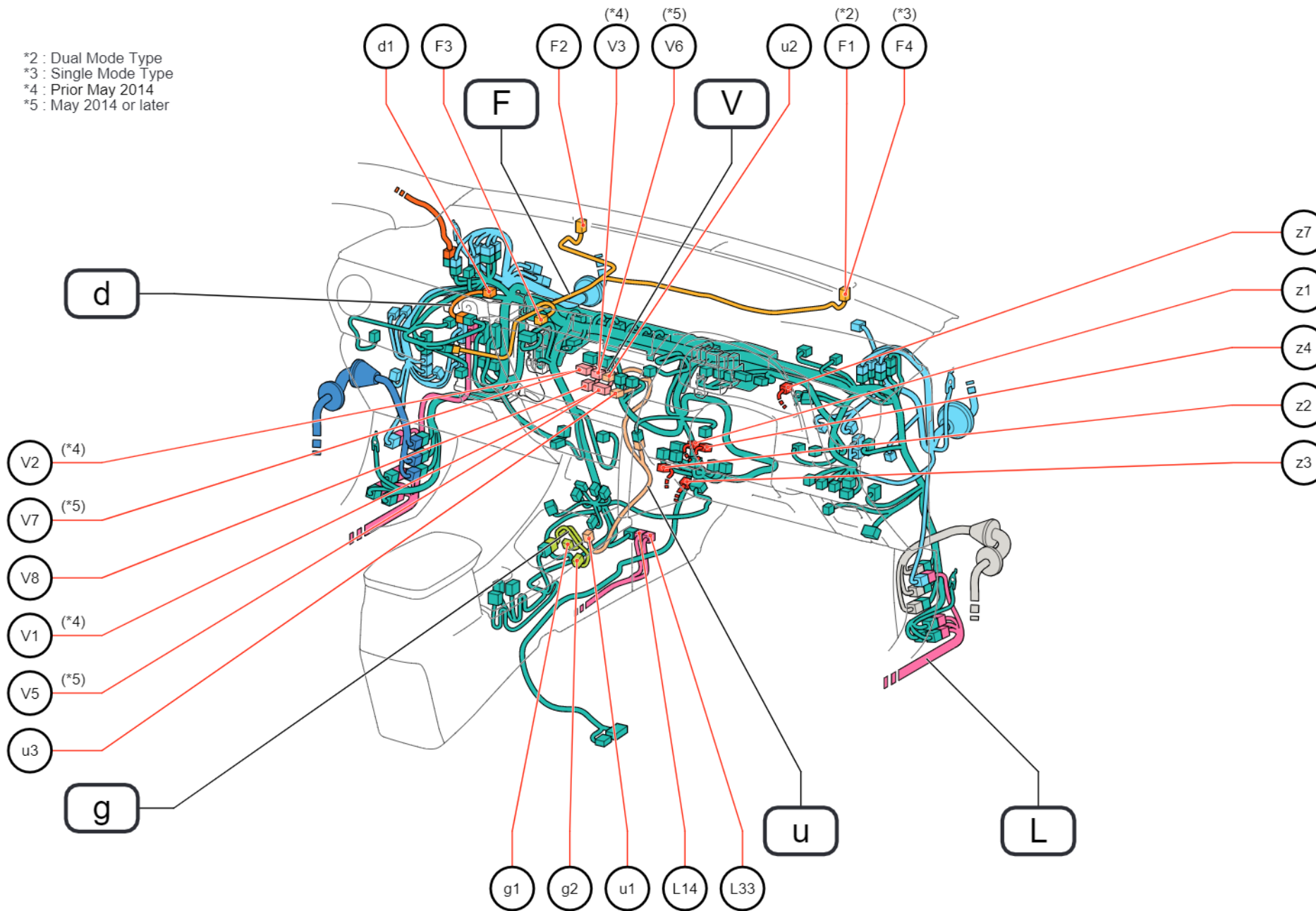

Position of Parts in Instrument Panel <RHD>

---

- F 1 Cooler Thermistor (Solar Sensor)
- F 2 Automatic Light Control Sensor
- F 3 Clock Assembly
- F 4 Cooler Thermistor (Solar Sensor)
  
- L 14 Airbag Sensor Assembly
- L 33 Airbag Sensor Assembly
  
- V 1 Extension Module
- V 2 Radio & Display Receiver Assembly
- V 3 Radio & Display Receiver Assembly
- V 5 Extension Module
- V 6 Radio & Display Receiver Assembly
- V 7 Radio & Display Receiver Assembly
- V 8 Extension Module
  
- d 1 Instrument Panel Passenger Airbag Assembly
  
- g 1 No. 1 Shift Lever Position Sensor
- g 2 No. 2 Shift Lever Position Sensor
  
- u 1 No. 1 Stereo Jack Adapter Assembly
- u 2 Radio & Display Receiver Assembly
- u 3 Extension Module
  
- z 1 Steering Pad Switch Assembly , Spiral Cable Sub-Assembly
- z 2 Driver Side Squib Assembly (Horn Button Assembly) , Spiral Cable Sub-Assembly
- z 3 A/C Blower Assembly (A/C Harness Assembly) , A/C Amplifier Assembly
- z 4 Cruise Control Main Switch , Spiral Cable Sub-Assembly
- z 7 Power Steering ECU Assembly,Power Steering Torque Sensor

Position of Parts in Instrument Panel <RHD>

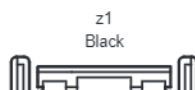
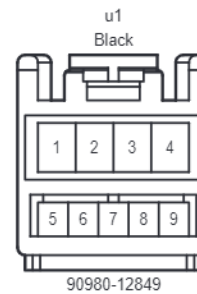
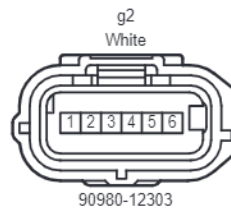
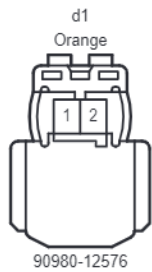
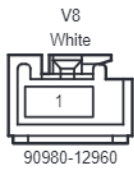
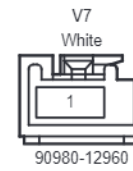
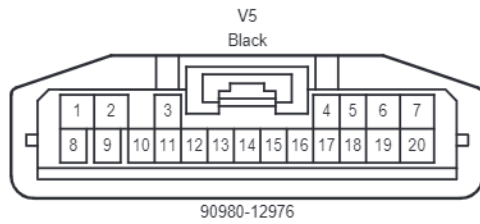
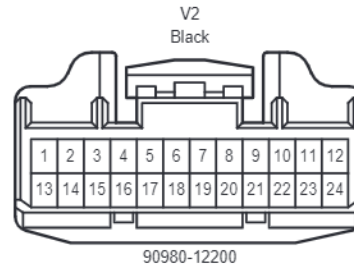
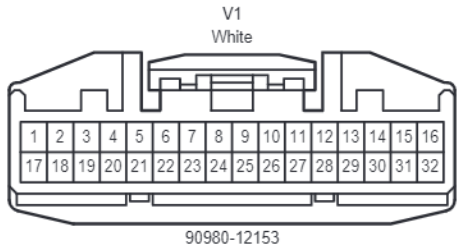
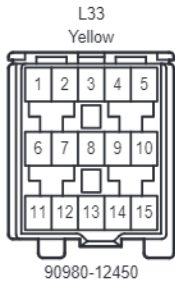
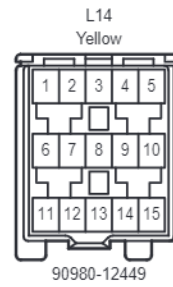
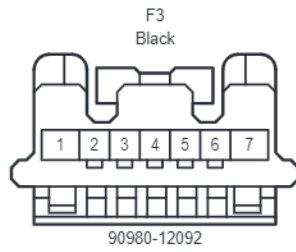
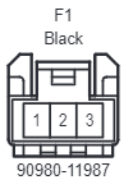

Position of Parts in Instrument Panel <RHD>

---

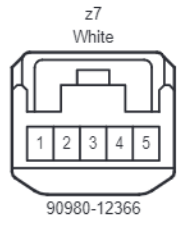
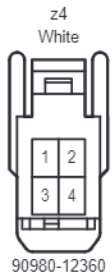

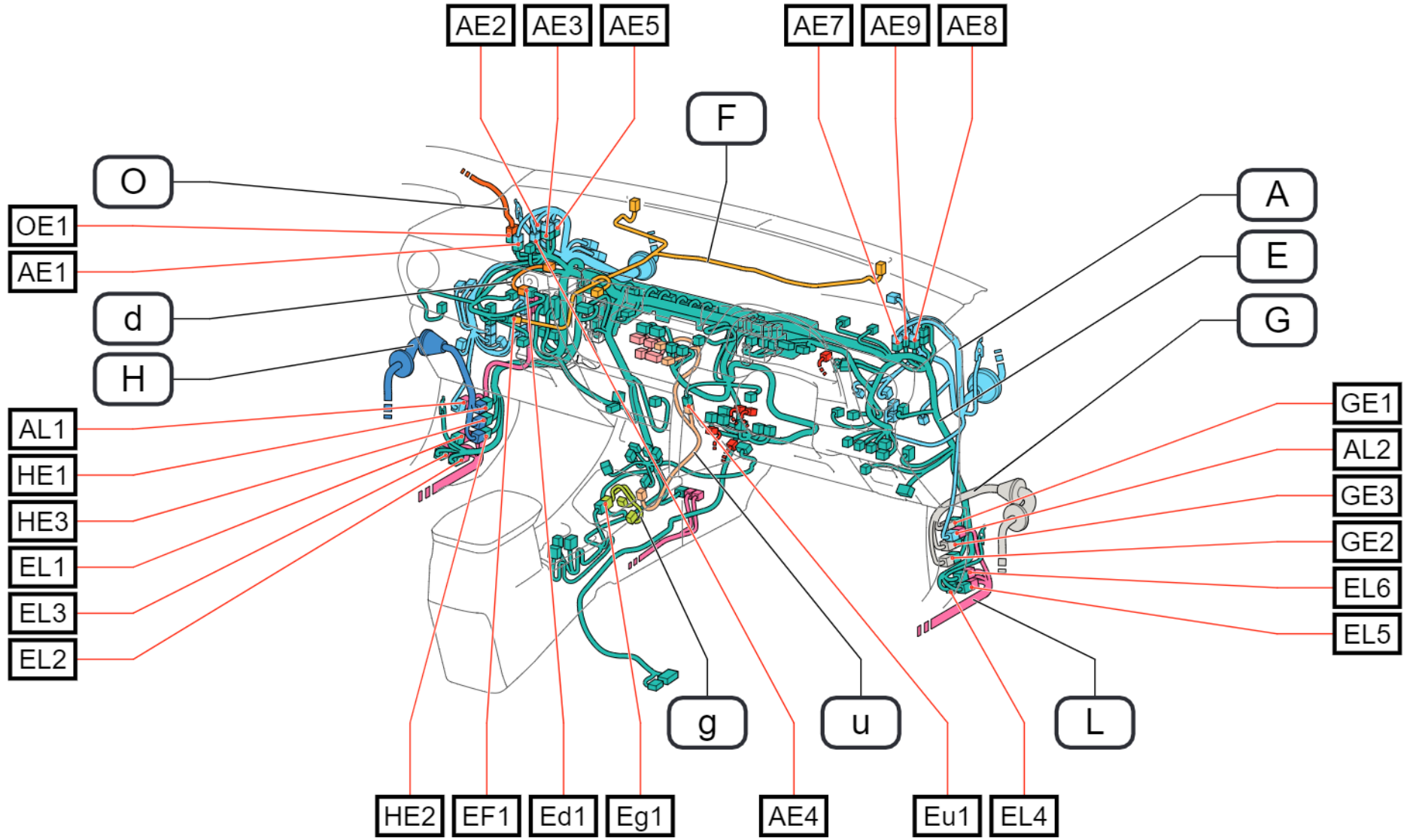

Wire and Wire in Instrument Panel <RHD>

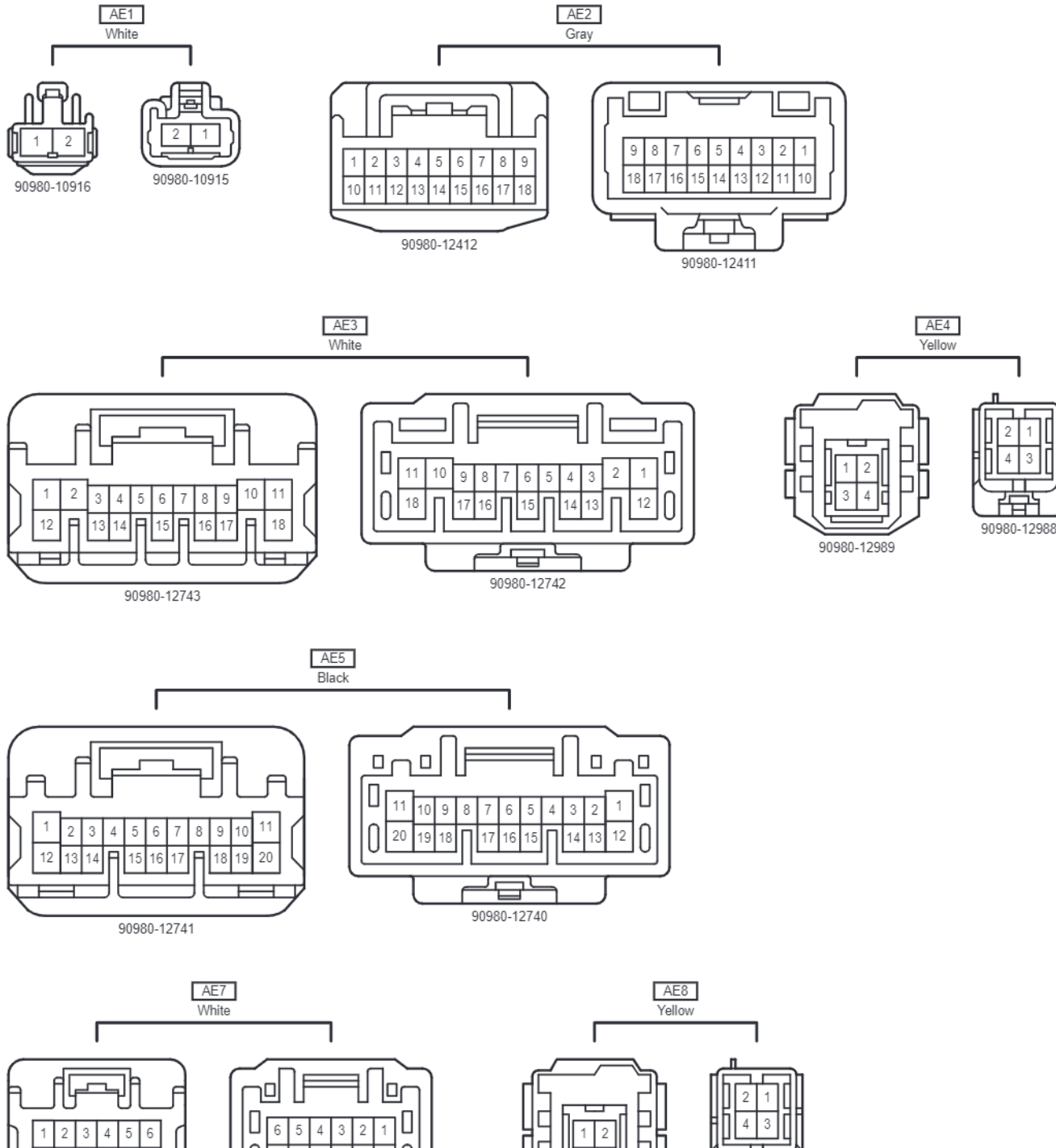



Wire and Wire in Instrument Panel <RHD>

AE9  
Gray

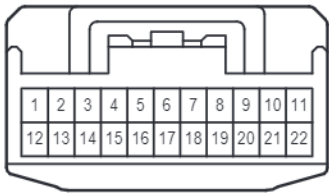

90980-12372

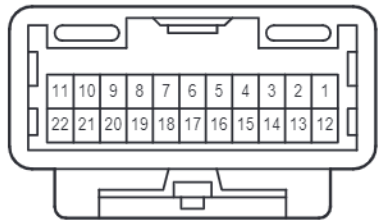

90980-12371

AL1  
White

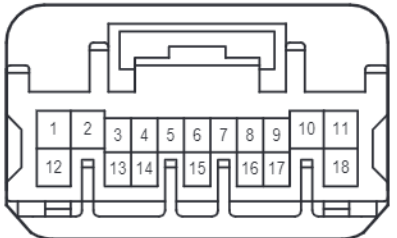

90980-12743

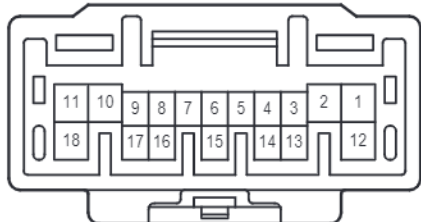

90980-12742

AL2  
White

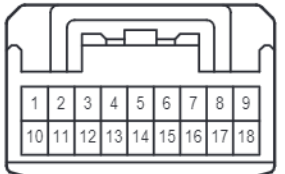

90980-12412

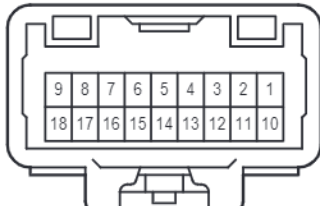

90980-12411

EF1  
White



90980-12368



90980-12367

EL1  
White

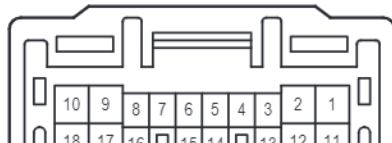
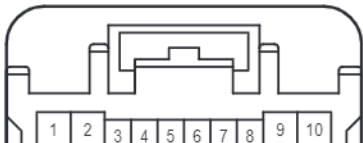

Wire and Wire in Instrument Panel <RHD>

EL2  
Black

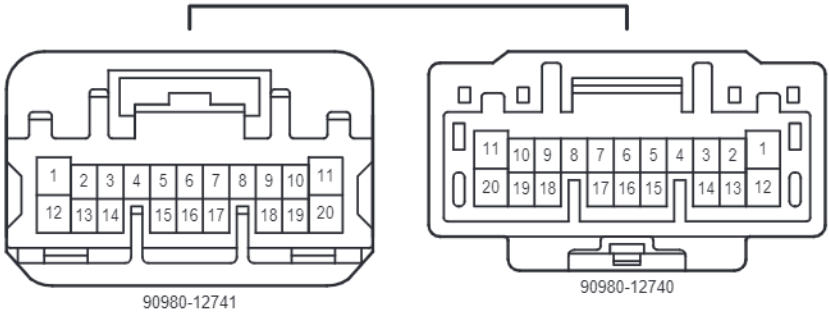

EL3  
Gray

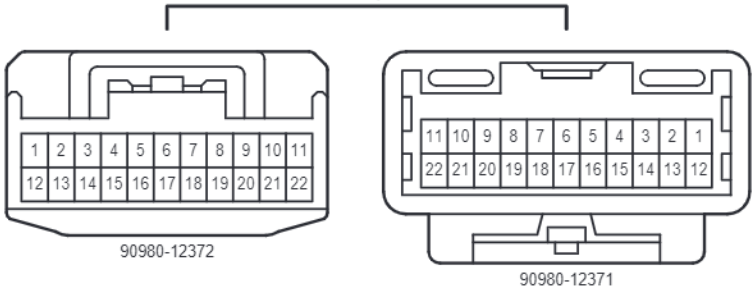

EL4  
Black

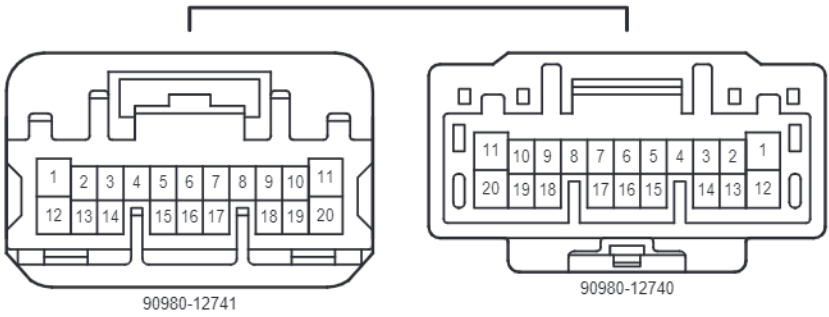

EL5  
Gray



EL6  
White



cardiagn.com

Wire and Wire in Instrument Panel <RHD>

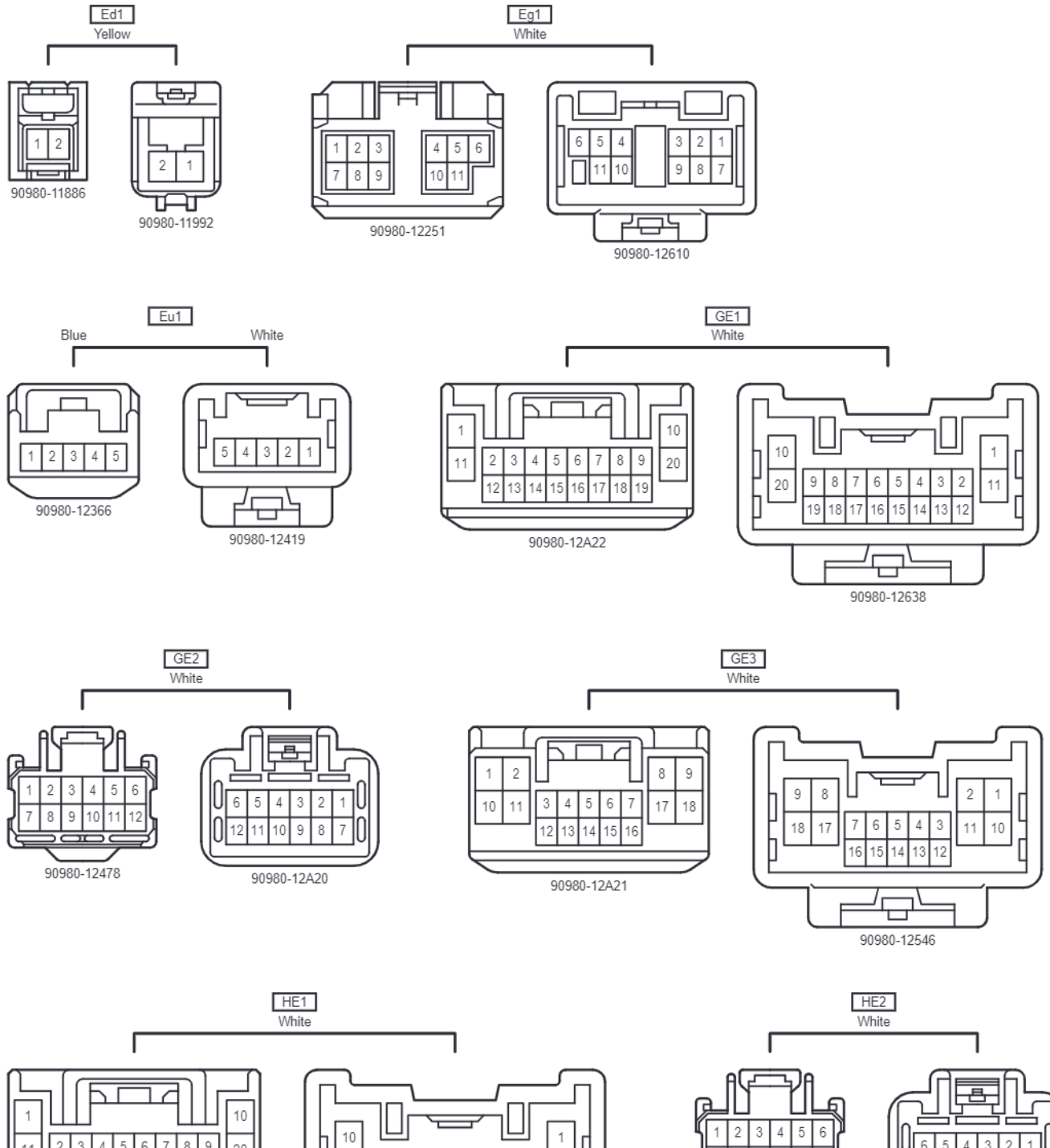

Wire and Wire in Instrument Panel <RHD>

HE3  
White

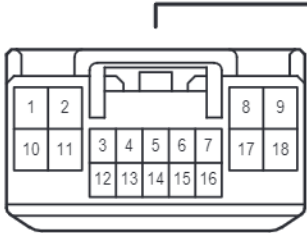

90980-12A21

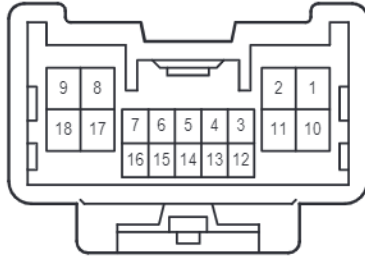

90980-12546

OE1  
White

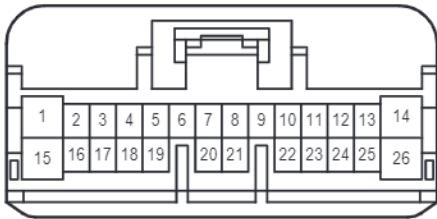

90980-12771

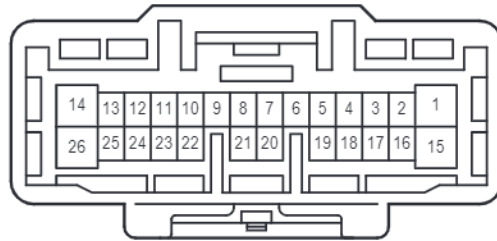

90980-12770

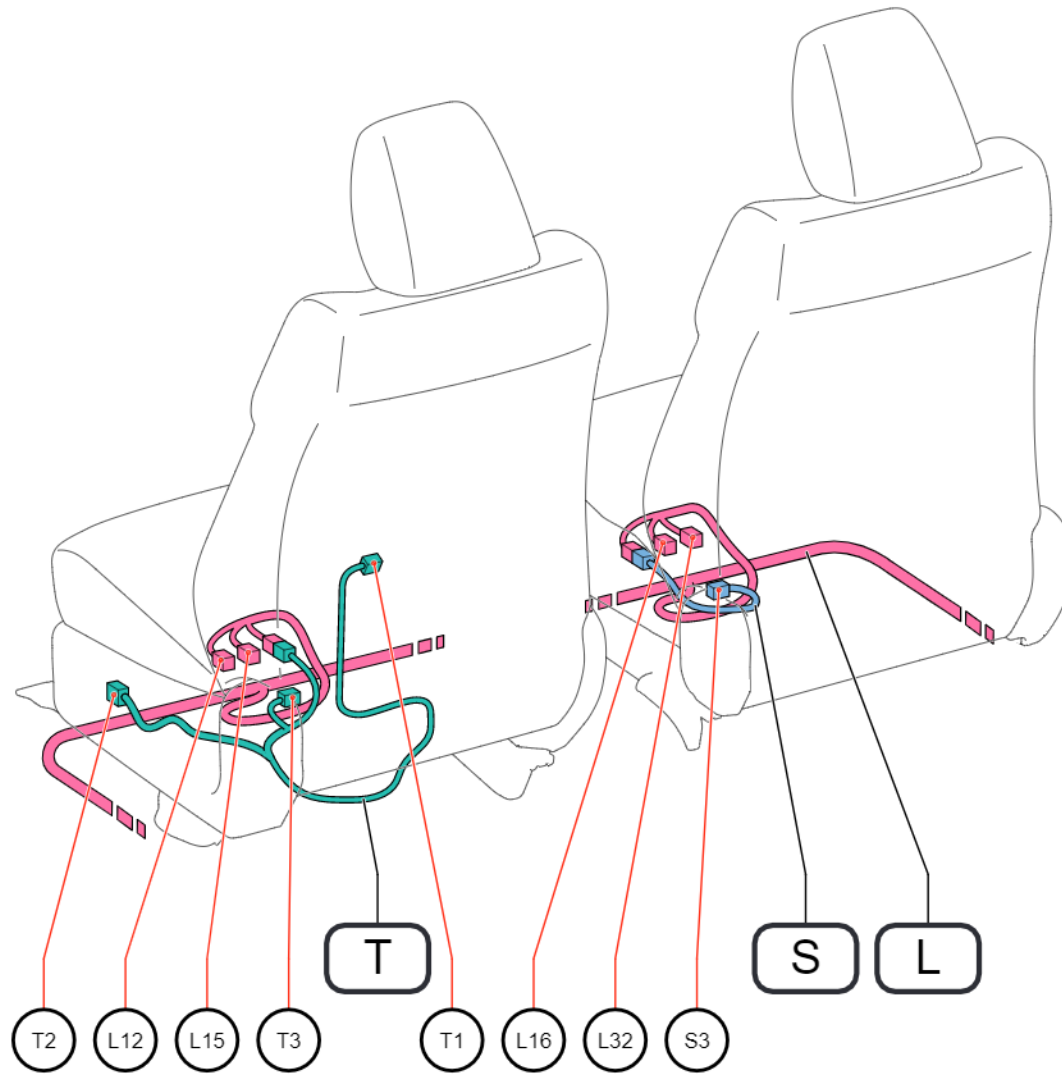

Position of Parts in Seat <LHD>

---

- L 12 Front Seat Airbag Assembly LH
- L 15 Front Seat Inner Belt Assembly LH
- L 16 Front Seat Inner Belt Assembly RH
- L 32 Front Seat Airbag Assembly RH
  
- S 3 Front Seat Cushion Heater Assembly RH
  
- T 1 Front Power Seat Lumbar Support Motor LH (Front Seat Assembly LH)
- T 2 Front Power Seat Lumbar Support Switch LH
- T 3 Front Seat Cushion Heater Assembly LH

Position of Parts in Seat <LHD>

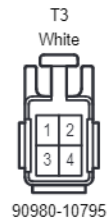
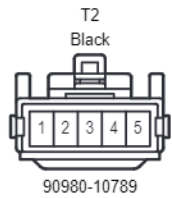
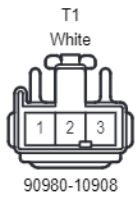
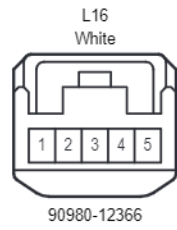
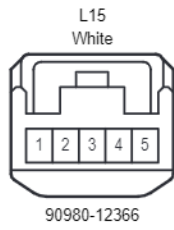

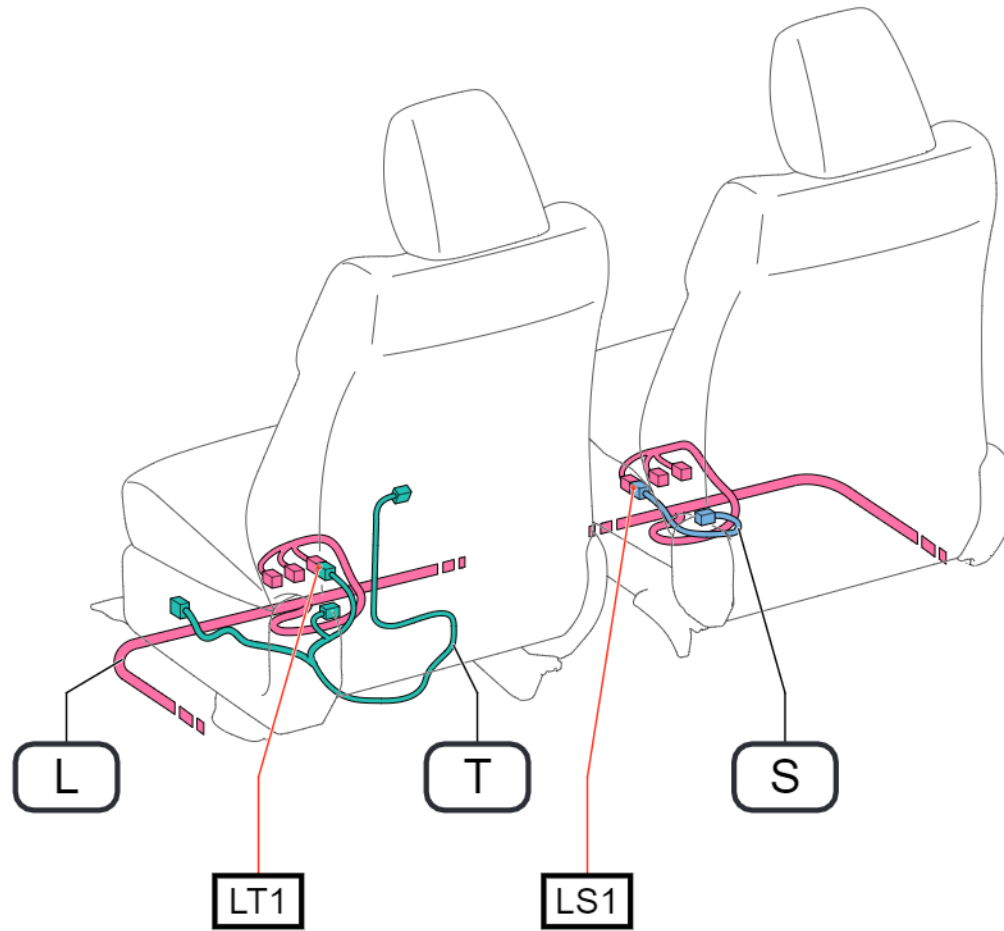



Wire and Wire in Seat <LHD>

---

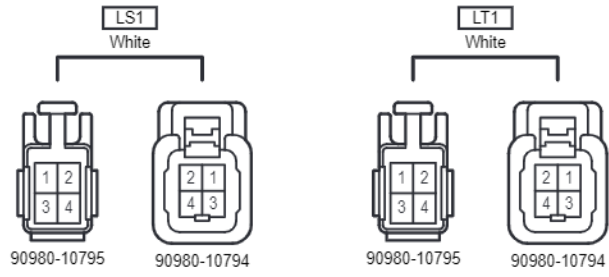

Position of Parts in Seat <RHD>

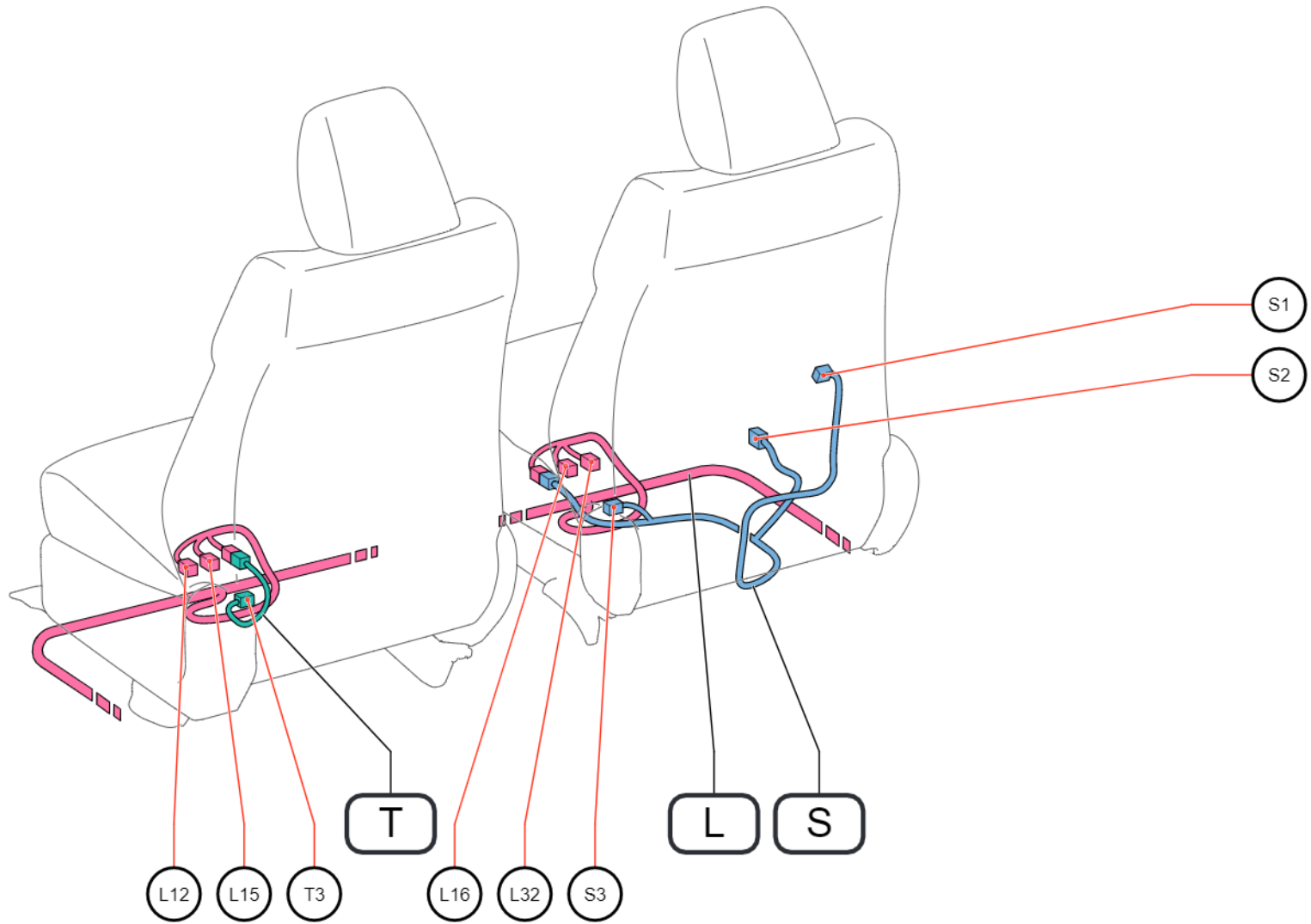

Position of Parts in Seat <RHD>

---

- L 12 Front Seat Airbag Assembly LH
- L 15 Front Seat Inner Belt Assembly LH
- L 16 Front Seat Inner Belt Assembly RH
- L 32 Front Seat Airbag Assembly RH
  
- S 1 Front Power Seat Lumbar Support Motor RH (Front Seat Assembly RH)
- S 2 Front Power Seat Lumbar Support Switch RH
- S 3 Front Seat Cushion Heater Assembly RH
  
- T 3 Front Seat Cushion Heater Assembly LH

Position of Parts in Seat <RHD>

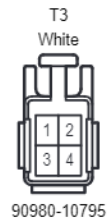
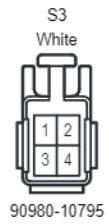
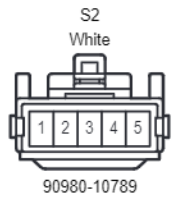
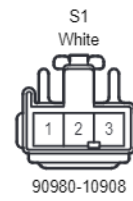
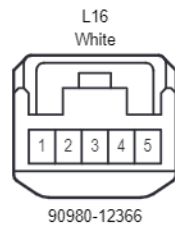
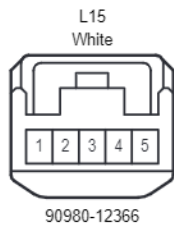

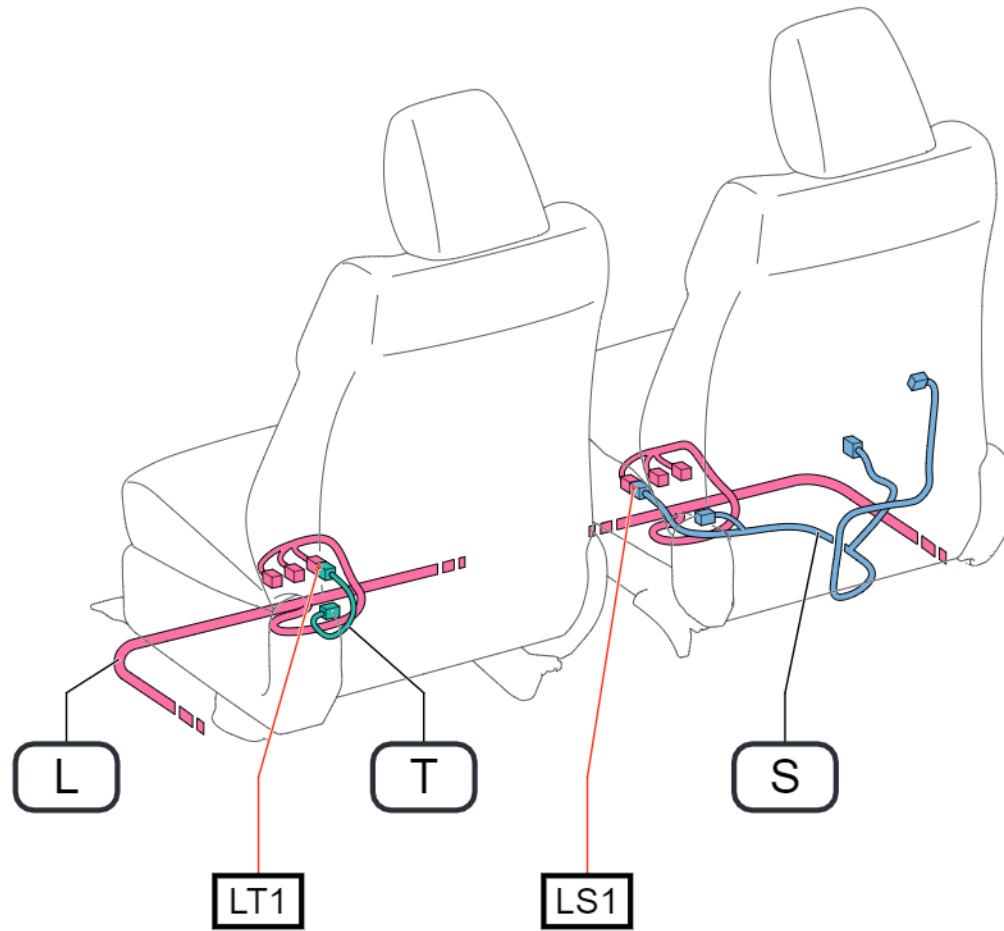

Wire and Wire in Seat <RHD>

